



PIX

Power Transmission Solutions

Driving growth!

Combine Harvester Belts

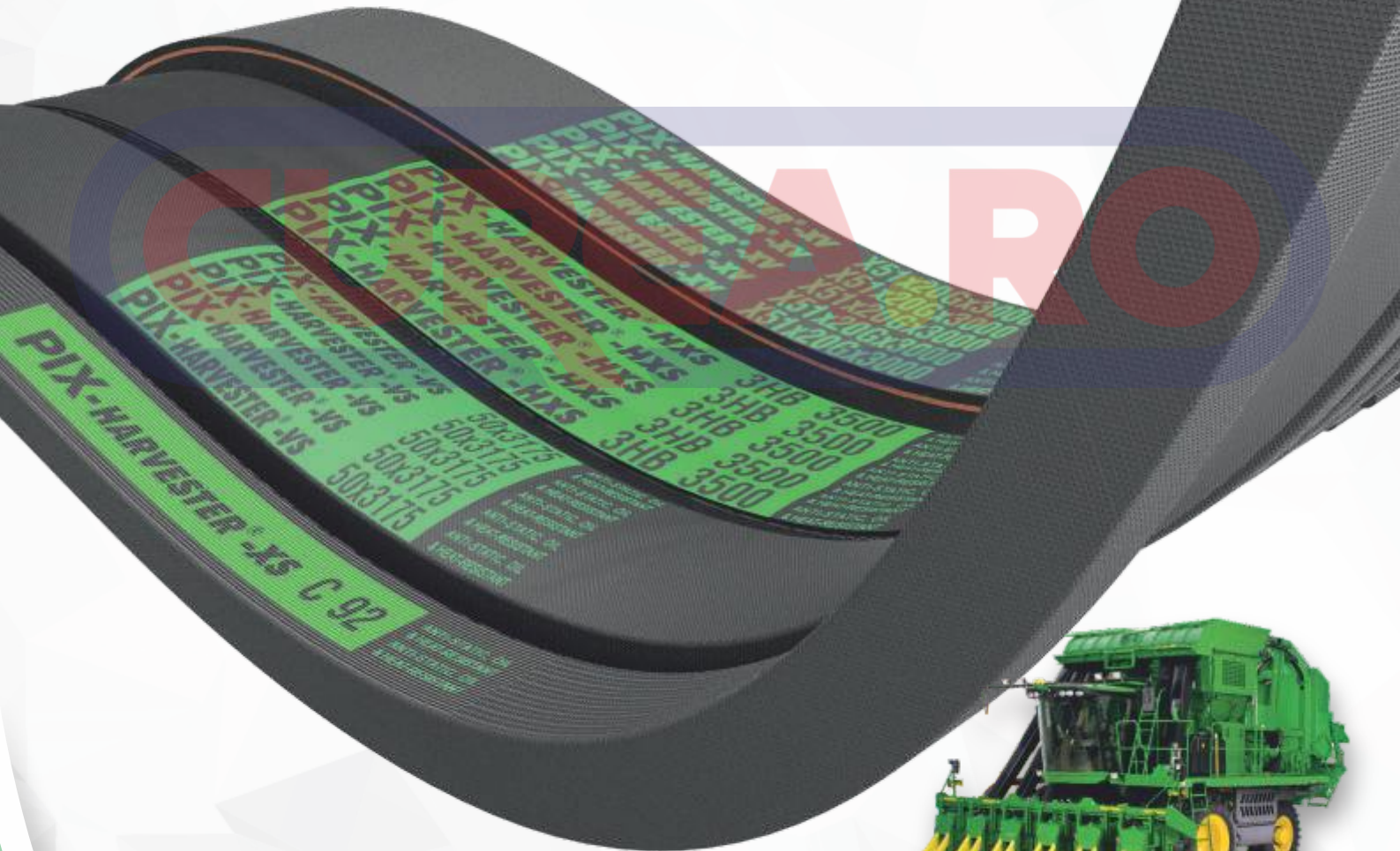

www.pixtrans.com



     @pixtrans

INDEX

| | |
|------------------------------|---------------|
| INTRODUCTION | AG-1 |
| PIX-COMBINE HARVESTER BELTS | AG-2 to AG-18 |
| CASE INTERNATIONAL HARVESTER | 1 - 36 |
| CLAAS | 37 - 167 |
| DEUTZ FAHR | 168 - 184 |
| DRONNINGBORG | 185 - 201 |
| FENDT | 202 - 203 |
| FORTSCHRITT | 204 - 207 |
| GLEANER | 208 - 226 |
| JOHN DEERE | 227 - 384 |
| KRONE | 349 |
| LAVERDA | 350 - 395 |
| MASSEY FERGUSON | 396 - 443 |
| NEW HOLLAND | 444 - 572 |
| ROSTSELMASH | 573 - 582 |
| SAMPO | 583 - 585 |

BELT GUIDE BY OE PART NUMBERS

| | |
|-----------------------------|-----------|
| AGCO | 586 - 601 |
| ALLIS GLEANER | 601 - 603 |
| BIZON | 603 |
| CASE INTERNATIONAL | 603 - 621 |
| CASE NEW HOLLAND | 621 - 634 |
| CLAAS | 634 - 640 |
| DEUTZ FAHR | 640-641 |
| FORTSCHRITT | 641 |
| GRIMME | 642 |
| HORWOOD BAGSHAW | 642 - 644 |
| JF FABRIKEN | 645 - 646 |
| JOHN DEERE | 646 - 660 |
| KPAB | 661 |
| KRONE | 661 |
| KUNH | 662 |
| KVERNELAND | 662 - 664 |
| LAVERDA | 665 - 666 |
| MASSEY FERGUSON | 667 - 671 |
| MENGELE | 672 |
| POTTINGER | 672 |
| ROSTSELMASH | 673 |
| SAME-DEUTZ-FAHR | 674 - 683 |
| SAMPO | 683- 684 |
| ZMAJ | 684 |
| PREVENTIVE MAINTENANCE TIPS | 685 - 686 |

PIX-HARVESTER® BELTS

Introduction:

Harvester combines drives are subjected to the most strenuous operations, the dust, the soil, stone granules, stray remains of the harvested crops are likely to create interference during the operation. The drive is often subjected to extreme weather conditions such as hot sunny days, extreme winters and rainy season.

Nevertheless the drive also uses a small size idler which in turn puts a lot of pressure on the Belt resulting into unavoidable increase in temperature and may cause the Belt to deform & reduction in its life. All these factors calls for a very special construction for the Belts which are used in the harvester combines.

PIX which is already an established name in manufacturing of application specific Belts has developed Belts meant specially for the agricultural industry. PIX Harvester Belts are the result of its over three decades of research and experience in the field of mechanical power transmission where the Belts are subjected to stringent conditions. The Belts are made resistant to all the extremities encountered in the Harvester Combines.

Considering the huge and varied demand from equipment used in agriculture. PIX has developed a huge range of Belts covering the entire spectrum of Agricultural application from Harvester Combines to the tractors and the equipment used as an attachment to the combines or tractors.

PIX Harvester Combine Belts are designed to follow the international standard norms used by the original equipment manufacturers and are widely used in the replacement market and offers a trouble-free and zero-maintenance life.

PIX Harvester Belts are available in - Wrapped Construction, Moulded Raw Edge Cogged Construction, Ribbed / Poly V-Belts and Flat Belts.

PIX Harvester Belts are made up of -

- Superior tensile members with specially formulated rubber compound to withstand the rough and tough conditions encountered in Harvester Combines.
- They are resistant to shock loads, vibrations and high abrasion with very low elongation.
- They are antistatic and oil resistant.

The features list is exhaustive, the detailed features are listed ahead.

PIX-HARVESTER[®]-XS

Wrapped Harvester Belts

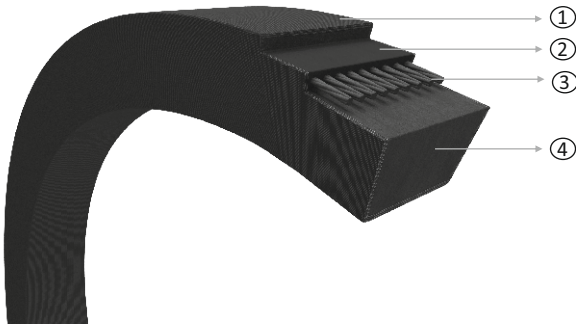

Construction:

1. Polychloroprene-impregnated poly-cotton fabric
2. Especially designed high-modulus cushion compound
3. Extra high tensile polyester cord (available in aramid cord also)
4. Especially designed high-modulus compression rubber

Features:

- High power transmission capacity than standard Belts
- Specially designed for reverse idler application
- High longitudinal flexibility suitable for small pulley/reverse idler drives
- High strength tensile member with minimum elongation prevents the Belt against shock-loads
- No bottom cracking/chipping, as the Belt design is application-specific
- Suitable for reverse bend drive
- Anti-static, oil, and heat resistant.
- Lateral rigidity along the sides of the Belt prevents the deformation
- Significant performance under variable speed conditions
- Low stretch due to high tensile strength cords

Temperature range:

-30°C to 80°C for standard Belts

-25°C to 100°C for special requirement Belts

Reference Standards: BS 3790, DIN 2215, RMA IP 22, ISO 4184, IS 2494

ISO 5289, IS 11038, ISO 3410, ASAE 211.4

Belt Label:

PIX-HARVESTER[®]-XS B 80

PIX-HARVESTER®-XS

Wrapped Harvester Belts

Classical Section

Product range:

| Section | Dimensions | | | Recommended Minimum Pulley Diameter (mm) | Manufacturing Range | |
|---------|------------|---------|-----------------|--|---------------------|------------|
| | Tw (mm) | Th (mm) | Angle (Degrees) | | Min (inch) | Max (inch) |
| AG-A | 13 | 8 | 40 | 71 | 16 | 356 |
| AG-B | 17 | 11 | 40 | 112 | 16 | 927 |
| AG-C | 22 | 14 | 40 | 180 | 31 | 927 |
| AG-25 | 25 | 16 | 40 | 250 | 57 | 356 |
| AG-D | 32 | 19 | 40 | 355 | 44.5 | 927 |

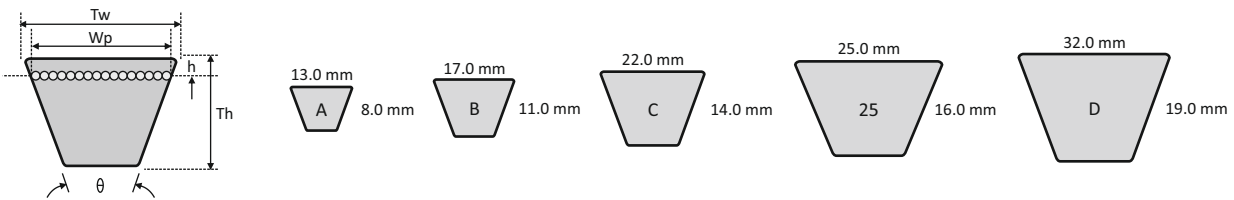

Wedge Section

Product range:

| Section | Dimensions | | | Recommended Minimum Pulley Diameter (mm) | Manufacturing Range | |
|---------|------------|---------|-----------------|--|---------------------|----------|
| | Tw (mm) | Th (mm) | Angle (Degrees) | | Min (mm) | Max (mm) |
| AG-SPZ | 10 | 8 | 40 | 63 | 479 | 4025 |
| AG-SPA | 13 | 10 | 40 | 90 | 576 | 9087 |
| AG-SPB | 17 | 14 | 40 | 140 | 1000 | 23606 |
| AG-19 | 19 | 15 | 40 | 180 | 2253 | 9111 |
| AG-SPC | 22 | 18 | 40 | 224 | 1861 | 23629 |

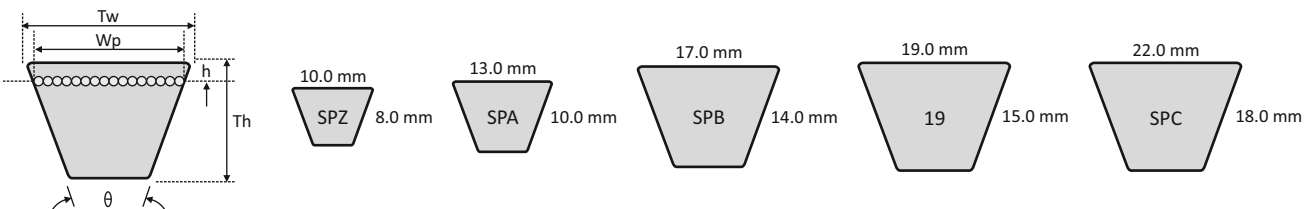

PIX-HARVESTER®-XS

Wrapped Harvester Belts

Narrow Section

Product range:

| Section | Dimensions | | | Recommended Minimum Pulley Diameter (mm) | Manufacturing Range | |
|---------|------------|---------|-----------------|--|---------------------|------------|
| | Tw (mm) | Th (mm) | Angle (Degrees) | | Min (inch) | Max (inch) |
| AG-3V | 9.7 | 8.0 | 40 | 63 | 19.5 | 160 |
| AG-5V | 15.8 | 13.5 | 40 | 140 | 48 | 930 |
| AG-8V | 25.4 | 23.0 | 40 | 335 | 100 | 933 |

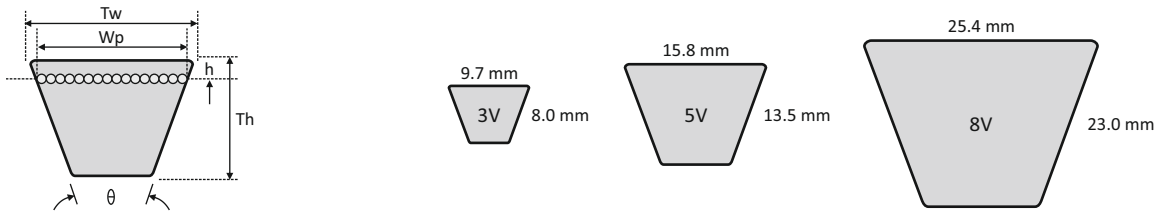

PIX-HARVESTER®-XS

Wrapped Hexagonal Belts

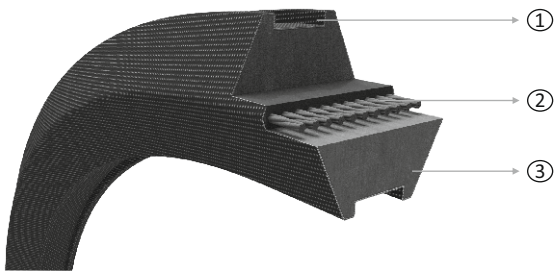

Construction:

1. Special CR impregnated outer jacketing fabric
2. High tensile strength polyester cords
3. Fibre-loaded base compound

Features:

- Enhanced product life
- Transmits power from both the sides
- Center cord provides high tensile strength and low stretch
- Special design provides the excellent flexibility required in twin power drives

Temperature range:

-30°C to 80°C for standard Belts

Reference Standards: BS 3733: 1974, ASAE 211-3 & 4

Product range:

| Section | Dimensions | | | Recommended Minimum pulley diameter (mm) | Manufacturing Range | |
|---------|------------|---------|-----------------|--|---------------------|------------|
| | Tw (mm) | Th (mm) | Angle (Degrees) | | Min (inch) | Max (inch) |
| AG-AA | 13 | 10 | 40 | 80 | 48 | 256 |
| AG-BB | 17 | 14 | 40 | 125 | 43 | 924 |
| AG-CC | 22 | 17 | 40 | 224 | 77 | 924 |
| AG-25 | 25 | 22 | 40 | 280 | 92 | 925 |

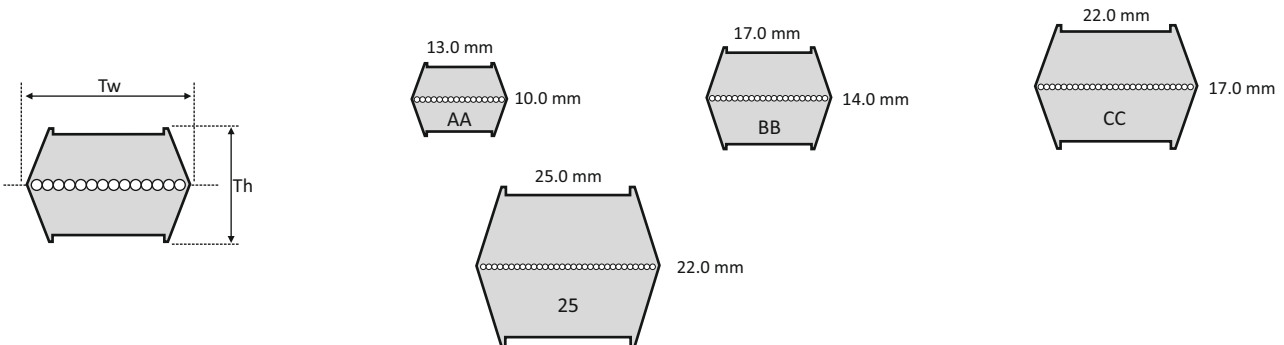

Product label:

PIX-Duo®-XS BB 85

PIX-HARVESTER®-HXS

Wrapped Banded Harvester Belts

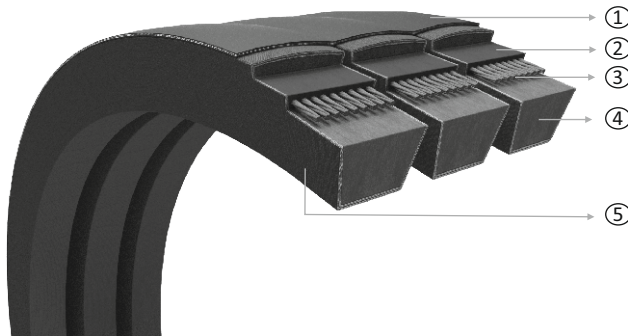

1. Special Curved top tie band design for better flexibility and heat resistance
2. High modulus - low shrinkage tension member embedded cushion rubber compound
3. High tenacity, low stretch specially treated polyester cords
4. Specially designed compression rubber gives stability to the Belt cross-section and supports the cord zone against deflection, under load conditions
5. Wear-resistant, bias-cut neoprene rubberised polyester cotton fabric

Features:

- Extended service life
- High power transmission capacity than standard Belts
- High-strength tensile member with minimum elongation
- Controlled radial and lateral run-out, facilitating smooth operation
- Top curvature provides superior adhesion and accelerates the heat dissipation rate
- Anti-static, oil, and heat resistant

Temperature range:

-30°C to 80°C for standard Belts

Reference Standards: BS 3790, ASAE211-3 & 4, RMA IP-22

Product range:

| Section | Dimensions | | | | Recommended Minimum pulley diameter (mm) | Manufacturing Range | |
|---------|------------|---------|-----------------|------------|--|---------------------|----------|
| | Tw (mm) | Th (mm) | Angle (Degrees) | Pitch (mm) | | Min. | Max. |
| AG-HA | 13 | 10.5 | 40 | 15.9 | 80 | 33" | 394" |
| AG-HB | 17 | 13.5 | 40 | 19 | 130 | 49" | 927" |
| AG-HC | 22 | 17 | 40 | 25.5 | 210 | 47" | 927" |
| AG-HSPZ | 10 | 10 | 40 | 12 | 67 | 1180 mm | 6539 mm |
| AG-HSPA | 13 | 12 | 40 | 15 | 100 | 959 mm | 4363 mm |
| AG-HSPB | 17 | 17 | 40 | 19 | 160 | 1762 mm | 10068 mm |
| AG-HSPC | 22 | 22.5 | 40 | 25.5 | 224 | 1632 mm | 23629 mm |
| AG-H3V | 9.7 | 10.5 | 40 | 10.3 | 67 | 35" | 171.5" |
| AG-H5V | 15.8 | 16.5 | 40 | 17.5 | 180 | 50" | 931.5" |

Note: Aramid cord construction Belts are available upon request.

Belt Label:

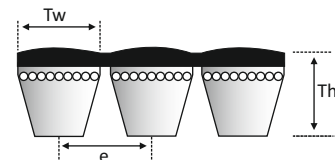

PIX-HARVESTER®-VS

Variable-speed Wrap Belts for Combine Harvesters



Construction:

1. Wear resistant bias-cut neoprene rubberised polyester cotton fabric
2. High tenacity, low stretch, specially treated polyester cords
3. Especially compounded high-modulus compression rubber

Features:

- High power transmission rate than standard Belts
- Superior lateral rigidity for effective power transmission
- High wear resistance outer cover
- High tensile strength cord with minimum elongation
- Excellent performance under variable load conditions
- Anti-static, oil, and heat resistant

Temperature range:

-18°C to +80°C

Reference Standards: ISO 3410:1989 / BS 3733:1974, ASAE 211-3 & 4

Product range:

| Cross Section | Top width (Nominal) (mm) | Thickness (Nominal) (mm) | Angle (Degrees) | Manufacturing Range | |
|---------------|--------------------------|--------------------------|-----------------|---------------------|----------|
| | | | | Min | Max |
| AG-HI | 25 | 13 | 30 | 1133 mm | 6555 mm |
| AG-HJ | 32 | 15 | 30 | 1192 mm | 9103 mm |
| AG-HK | 38 | 18 | 30 | 1500 mm | 9119 mm |
| AG-HL | 45 | 20 | 30 | 1608 mm | 6586 mm |
| AG-HM | 51 | 22 | 30 | 1891 mm | 10100 mm |

Non-standard sizes

| Section | Angle (Degrees) | Manufacturing Range | |
|----------|-----------------|---------------------|----------|
| | | Min (mm) | Max (mm) |
| AG-13x11 | 40 | 1065 | 3988 |
| AG-15x9 | 40 | 571 | 6502 |
| AG-19x11 | 40 | 1056 | 3945 |
| AG-21x9 | 40 | 990 | 3988 |
| AG-22x11 | 40 | 1067 | 9042 |
| AG-22x16 | 40 | 1727 | 6502 |
| AG-30x12 | 30 | 1626 | 6502 |
| AG-40x20 | 30 | 1727 | 6502 |
| AG-55x22 | 30 | 1829 | 6502 |
| AG-60x25 | 30 | 1854 | 6502 |
| AG-68x24 | 32 | 2438 | 9042 |

Note: Other sizes are available upon request.

PIX-ENFORCER®-XS

Heavy-duty, Aramid-corded, Inversely Flexible Wrap Belts

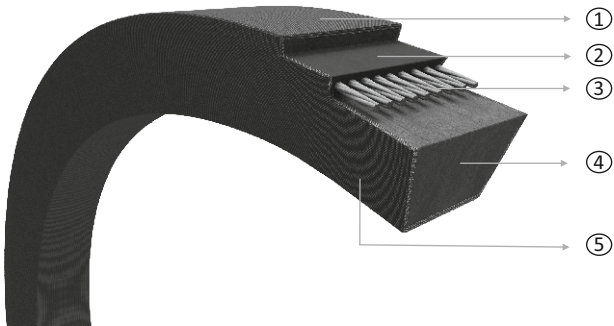

- ① 1. Special top fabric layer
- ② 2. Adhesion rubber
- ③ 3. Especially treated aramid tensile member provides extra strength & low belt stretch
- ④ 4. High modulus rubber base compound
- ⑤ 5. Multi-layer fabric provides extra strength and acts as a crack barrier during the reverse bend

Features:

- Superior power transmission capacity as compared to standard Belts
- Specially treated outer cover fabric for high wear resistance
- Specially coated aramid cord enhances the adhesion strength and offers minimum elongation
- Unique design in wrap construction to facilitate operation on smaller pulley diameters with an acute reverse bend
- High performance in variable load and reverse idler drives
- Longer service life

Temperature range:

-25°C to + 100°C

Reference Standards: PIX proprietary

Product range:

| Section | Top Width (mm) | Thickness (mm) | Angle (Degrees) | Manufacturing Range | |
|---------|----------------|----------------|-----------------|---------------------|------------|
| | | | | Min (inch) | Max (inch) |
| RH80-A | 13 | 8 | 40 | 46 | 185 |
| RH80-B | 17 | 10 | 40 | 46 | 156 |
| RH80-C | 22 | 11 | 40 | 46 | 196 |

Belt Label:

PIX-ENFORCER® - XS RH80 B 54
PIX-ENFORCER® - XS RH80 B 54

PIX-VALIANT[®]-XS

High-power, Inversely Flexible Wrap Belts

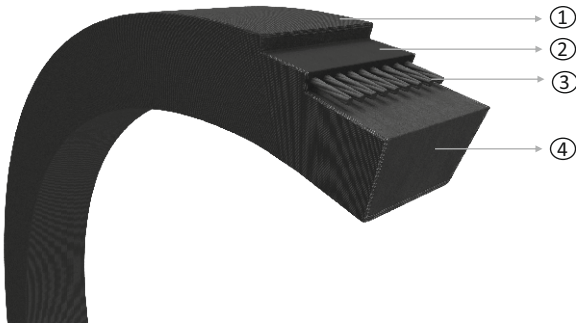

1. Especially designed woven fabric to enhance the flexibility, adhesion as well as high wear resistance properties
2. Specially treated polyester cords
3. Fibre-loaded high modulus base compound facilitates enhanced power transmission
4. Multi-layer fabric at the bottom to resist the premature crack formation

Features:

- High power transmission capacity as compared to standard Belts
- High tensile strength
- Special design in wrap construction to facilitate operation on small pulley diameter with an acute reverse bend
- Extended service life

Temperature range:

-25°C to + 100°C

Reference Standards: PIX proprietary

Product range:

| Section | Top Width (mm) | Thickness (mm) | Angle (Degrees) | Manufacturing Range | |
|---------|----------------|----------------|-----------------|---------------------|------------|
| | | | | Min (inch) | Max (inch) |
| RHR2-A | 13 | 8 | 40 | 46 | 185 |
| RHR2-B | 17 | 10 | 40 | 46 | 156 |
| RHR2-C | 22 | 11 | 40 | 46 | 196 |

Belt Label:



PIX-HARVESTER[®]-XR

Moulded Raw Edge Cogged, Harvester Belts



Construction:

1. Polychloroprene-impregnated biased fabric
2. Especially designed high modulus cushion rubber compound
3. Extra high tensile polyester cord (available in aramid cords also)
4. High modulus compression rubber
5. Moulded Coggs for better flexibility

Features:

- Higher power transmission capacity than standard Belts
- Enhanced longitudinal flexibility due to specially designed cog profile
- Suitable for drives using smaller diameter pulleys and high RPM
- Suitable for reverse bend drive
- Anti-static, oil, and heat resistant
- Unique combination of lateral rigidity to reduce the dishing effect, offering improved power transmission
- Specially designed compound for significant performance under variable speed conditions
- No bottom cracking/chipping, as the Belt design is application-specific
- Low stretch due to the high tensile strength cord used in the Belt

Temperature Range: -25°C to +100°C

Reference Standards: BS 3790, RMA IP 22, ISO 4184, ISO 5291, ISO 5290, ISO 3410, IS 2494, RMA IP 25, ASAE 211.4

Belt Label:



PIX-HARVESTER®-XR

Moulded Raw Edge Cogged, Harvester Belts

Classical Section

| Section | Dimensions | | | Recommended Minimum Pulley Diameter (mm) | Manufacturing Range | |
|---------|------------|---------|-----------------|--|---------------------|------------|
| | Tw (mm) | Th (mm) | Angle (Degrees) | | Min (inch) | Max (inch) |
| AG-AX | 13 | 8 | 36 | 63 | 21.5 | 200 |
| AG-BX | 17 | 11 | 36 | 90 | 21.5 | 330 |
| AG-CX | 22 | 14 | 36 | 140 | 23.5 | 330 |

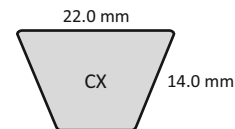
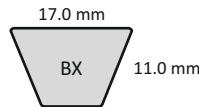
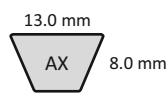
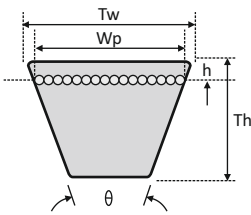

Wedge Section

| Section | Dimensions | | | Recommended Minimum Pulley Diameter (mm) | Manufacturing Range | |
|---------|------------|---------|-----------------|--|---------------------|----------|
| | Tw (mm) | Th (mm) | Angle (Degrees) | | Min (mm) | Max (mm) |
| AG-XPA | 13 | 10 | 36 | 71 | 550 | 5000 |
| AG-XPB | 16.3 | 14 | 36 | 112 | 550 | 8380 |
| AG-XPC | 22 | 18 | 36 | 180 | 600 | 8380 |

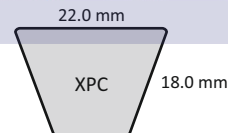
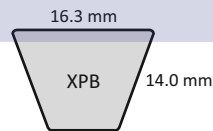
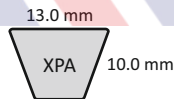
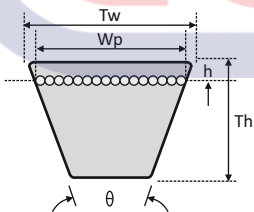

Narrow Section

| Section | Dimensions | | | Recommended Minimum Pulley Diameter (mm) | Manufacturing Range | |
|---------|------------|---------|-----------------|--|---------------------|------------|
| | Tw (mm) | Th (mm) | Angle (Degrees) | | Min (inch) | Max (inch) |
| AG-3VX | 9.7 | 8.0 | 38 | 56 | 21.5 | 200 |
| AG-5VX | 15.8 | 13.5 | 38 | 112 | 21.5 | 330 |

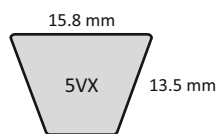
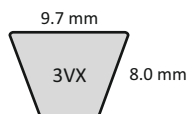
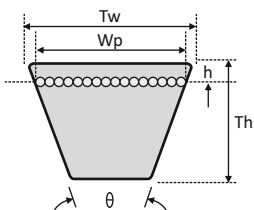

PIX-HARVESTER®-HXR

Moulded Raw Edge Cogged Banded, Harvester Belts

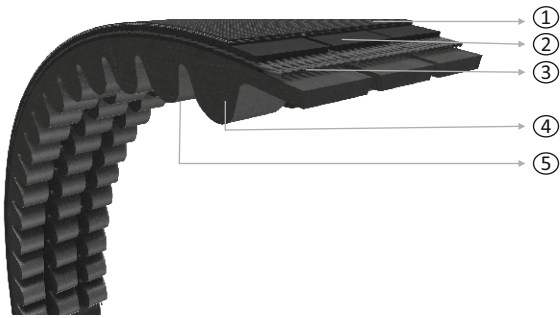

1. Especially designed top band for extra protection against reverse bend and foreign particles
2. High modulus cushion compound for superior adhesion
3. High tenacity, low stretch specially treated polyester cords
4. Fiber-loaded, thermal resistant, high modulus base compound
5. Moulded cog offers better flexibility and accelerates heat dissipation rate

Features:

- Extended power transmission capacity up to 25% as compared to standard single Belts
- Lesser number of Belts are required as compared to a multiple single-Belt drives
- Unique cog profile enhances the flexibility and heat dissipation rate
- Extended service life
- Anti-static, oil, and heat resistant

Temperature Range: -25°C to +100°C

Reference Standards: ISO 5290, BS 3790, RMA IP-22

Product range:

| Section | Dimensions | | | | Manufacturing Range | |
|---------|------------|---------|-----------------|------------|---------------------|--------|
| | Tw (mm) | Th (mm) | Angle (Degrees) | Pitch (mm) | Min. | Max. |
| AG-HAX | 13.0 | 10 | 36 | 15.9 | 23.5" | 200" |
| AG-HBX | 17.0 | 13 | 40 | 19.0 | 23.5" | 200" |
| AG-HCX | 22.0 | 16 | 36 | 25.5 | 23.5" | 200" |
| AG-HXPZ | 10.0 | 10 | 36 | 12.0 | 600mm | 5000mm |
| AG-HXPA | 13.0 | 12 | 36 | 15.0 | 600mm | 5000mm |
| AG-HXPB | 16.3 | 16 | 40 | 19.0 | 600mm | 5000mm |
| AG-HXPC | 22.0 | 20 | 36 | 25.5 | 600mm | 5000mm |
| AG-H3VX | 9.7 | 10 | 40 | 10.3 | 23.5" | 200" |
| AG-H5VX | 15.8 | 16 | 38 | 17.5 | 23.5" | 200" |

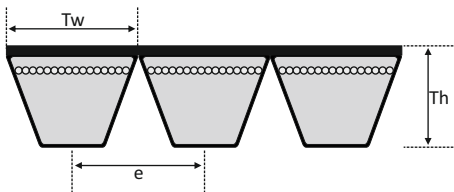

Belt Label:



PIX-HARVESTER®-XV

Moulded Raw Edge Cogged, Variable-speed, Harvester Belts

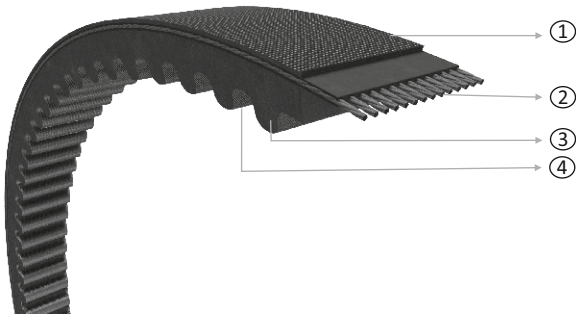

- ① 1. Special fabric layer
- ② 2. Specially treated and stabilised polyester cords
- ③ 3. Fibre-filled base compound
- ④ 4. Moulded cogs for better flexibility and also protected with the crack-resistant bottom fabric

Features:

- Excellent transverse rigidity and longitudinal flexibility to prevent bucking over minimum diameter pulleys
- Superior grip to avoid slippage while operating under frequent speed variations and longer service life
- Longer service-life
- Facilitates smooth running without excessive vibrations
- Anti-static, oil, and heat resistant

Temperature Range: -25°C to +100°C

Reference Standards: ISO 3410:1989 / BS 3733:1974, ASAE 211-3 & 4

Note: Aramid cord construction Belts are available upon request.

Product range:

| Cross Section | Top width (mm) | Thickness (mm) | Angle (Degrees) | Manufacturing Range | |
|---------------|----------------|----------------|-----------------|---------------------|-----------|
| | | | | Min. (mm) | Max. (mm) |
| AG-XHG | 17 | 8 | 26 | 550 | 5000 |
| AG-XHH | 20 | 10 | 26 | 550 | 5000 |
| AG-XHI | 25 | 13 | 26 | 550 | 5000 |
| AG-XHJ | 32 | 15 | 26 | 750 | 5000 |
| AG-XHK | 38 | 18 | 26 | 750 | 5000 |
| AG-XHL | 45 | 20 | 26 | 750 | 5000 |
| AG-XHM | 51 | 22 | 26 | 750 | 5000 |
| AG-XHN | 57 | 24 | 26 | 750 | 5000 |
| AG-XHO | 64 | 25 | 26 | 750 | 5000 |
| AG-XHQ | 76 | 30 | 30 | 750 | 5000 |

PIX-HARVESTER[®]-XV

Moulded Raw Edge Cogged, Variable-speed, Harvester Belts

Cross Section Nomenclature:

As per Metric System

14 22 V 450

14/16": Top Width

22: 22° Groove Angle

V: Variable Speed Belt

450: 45" Pitch length (Lp)

As per S.I. System

22 V 1150 A22

22: 22mm Top Width

V: Variable Speed Belt

1150: 1150mm Effective Length

A22: Groove Angle 22°



PIX- DOMINATOR[®]-XR

Heavy-duty, Aramid-corded Moulded Raw Edge Cogged Belts

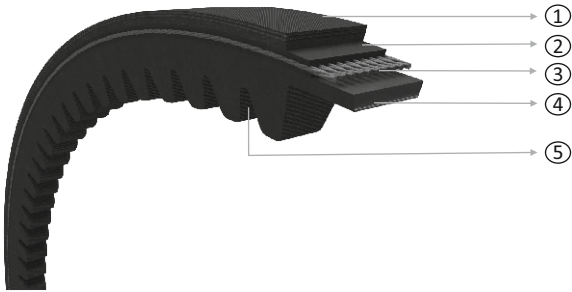

Construction:

1. Stretchable top fabric
2. Especially designed rubber compound
3. Aramid cord reinforcement for high tensile strength and minimal elongation
4. Fibre-filled high modulus base compound
5. Moulded cogs for better flexibility and also protected with the crack-resistant bottom fabric

Features:

- Superior high-power transmission capacity
- Aramid cord reinforcement for high tensile strength
- Lower elongation and slippage
- Excellent performance under heavy shock load conditions
- Superior lateral rigidity and longitudinal flexibility
- Suitable for drives with small pulley diameters
- Suitable for heavy-duty, high-speed applications
- Anti-static, oil, and heat resistant

Temperature range:

-25°C to + 100°C

Reference Standards: PIX proprietary

Product range:

| Section | Top Width (mm) | Thickness (mm) | Angle (Degrees) | Manufacturing Range | |
|---------|----------------|----------------|-----------------|---------------------|------------|
| | | | | Min (inch) | Max (inch) |
| RH10-BX | 17 | 10 | 38 | 22 | 85 |
| RH10-CX | 22 | 11 | 38 | 22 | 85 |

Belt Label:

PIX-DOMINATOR[®]-XR RH10 CX 52
PIX-DOMINATOR[®]-XR RH10 CX 52

PIX- SPECTRA®-XR

Centre-corded, Inversely Flexible Raw Edge Laminated Belts

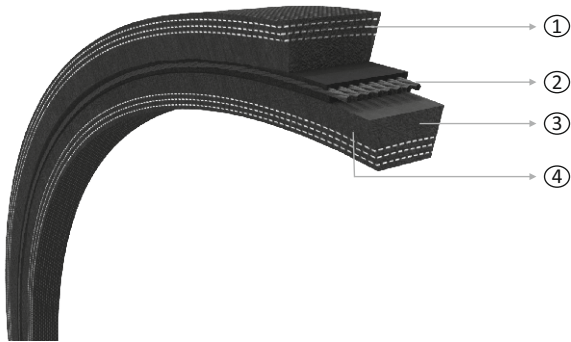

Construction:

1. Multi-Layer fabric provides extra strength and acts as a crack barrier during the reverse bend
2. High-modulus polyester cords are placed at the center position to neutralize the reverse bending stress
3. Special rubber compound for better grip on a smaller pulley for power transmission, support for cord and fabric, and dissipation of frictional heat at a faster rate for superior Belt life
4. Unique raw edge laminated side walls facilitate high power transmission and faster heat dissipation as compared to standard wrap Belts

Features:

- High power rating compared to standard Wrap Belts
- High tensile strength
- Improved flexibility and suitable for back idler applications
- Superior Belt life

Temperature range:

-25°C to + 100°C

Reference Standards: BS 3790

Product range:

| Section | Top Width (mm) | Thickness (mm) | Angle (Degrees) | Manufacturing Range | |
|---------|----------------|----------------|-----------------|---------------------|------------|
| | | | | Min (inch) | Max (inch) |
| CC-AX | 12.7 | 8.5 | 36 | 24 | 200 |
| CC-BX | 15.5 | 11.0 | 36 | 24 | 200 |
| CC-CX | 22.0 | 14.0 | 36 | 51 | 200 |

Belt Label:

PIX-Spectra®-XR BX 112
PIX-Spectra®-XR BX 112

PIX-HARVESTER®-XC

Ribbed / Poly-V Harvester Belts

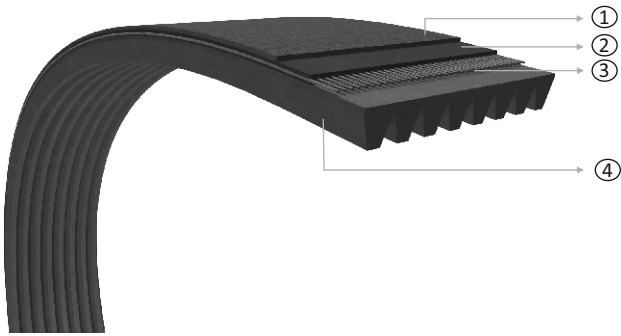

Construction:

1. Special design rubberised poly-cotton fabric
2. High modulus cushion rubber compound
3. High strength special treated polyester cords
4. High modulus compression rubber

Features:

- High power transmission capacity
- Suitable for small pulley diameters
- Maximum Belt linear speed up to 60 m/Sec
- Extended service-life
- High temperature resistant from: -35°C to +130°C

Reference Standard: RMA IP-26, ISO 9982, DIN 7867

Product range:

| Section | Belt Thickness (mm) 't' | Rib Pitch (mm) 'e' | Recommended Minimum Pulley Diameter (mm) | Manufacturing Range Effective Length (mm) | |
|---------|-------------------------|--------------------|--|---|--------------------|
| | | | | Min | Max |
| AG-PJ | 3.5 | 2.34 | 20 | 2 to 235 | 280mm to 5000mm |
| AG-PK | 4.5 | 3.56 | 45 | 2 to 150 | 280mm to 5000mm |
| AG-PL | 7.6 | 4.7 | 75 | 2 to 110 | 500mm to 5000mm |
| | | | | 2 to 78 | >5001mm to 12000mm |

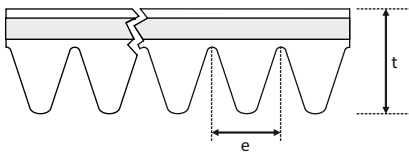

Belt Label:



PIX-HARVESTER[®]-AGF

Flat Harvester Belts



1. Special canvas outer jacket fabric
2. High modulus base rubber
3. Specially treated polyester cords

Features:



- High-abrasion-resistant outer cover
- High tensile strength with minimum elongation
- Suitable for harvester traction drive
- Temperature range: -18°C to +80°C

Reference Standard: PIX proprietary



Product range:

| Section | Top width (mm) | Thickness (mm) | Manufacturing Range (mm) | |
|---------|----------------|----------------|--------------------------|------|
| | | | Min. | Max. |
| 75F | 75 | 6 | 2692 | 8001 |
| 80F | 80 | 6 | 1727 | 6502 |
| 95F | 95 | 6 | 2692 | 8001 |
| 100F | 100 | 6 | 2159 | 8052 |
| 114F | 114 | 6 | 2692 | 8052 |
| 120F | 120 | 6 | 2692 | 8052 |
| 125F | 125 | 6 | 1727 | 6502 |
| 127F | 127 | 6 | 2692 | 8052 |
| 135F | 135 | 6 | 2692 | 8052 |
| 140F | 140 | 6 | 2692 | 8128 |
| 150F | 150 | 6 | 2692 | 8052 |



CASE INTL. HARVESTER 8-41

| Belt No. |  | No. of Belts | OEM  Part No. | PIX  Part No. |
|----------|---|--------------|--|--|
| 1 | Fan Drive | 1 | 793037R2 | A-793037R2 |
| 2 | Main Drive | 1 | 793051R2 | A-793051R2 |
| 3 | Straw Walker Drive | 1 | 793094R2 | A-793094R2 |
| 4 | Platform Drive | 1 | 793398R2 | A-793398R2 |
| 5 | Traction Drive | 1 | 793417R1 | A-793417R1 |
| 6 | Traction Variator Drive | 1 | 794464R2 | A-794464R2 |
| 7 | Return Auger Drive | 1 | 553456R2 | A-553456R2 |
| 8 | Unloading Drive | 1 | 790522R1 | A-790522R1 |
| 9 | Return Elevator Drive | 1 | 794484R1 | A-794484R1 |



CASE INTL. HARVESTER 8-51

| Belt No. |  | No. of Belts | OEM  Part No. | PIX  Part No. |
|----------|---|--------------|--|--|
| 1 | Feeder Auger - Reel Variator drive | 1 | 1408855R1 | A-1408855R1 |
| 2 | Platform Drive | 1 | 3155127R1 | A-3155127R1 |
| 2 | Platform Drive | 1 | 793398R2 | A-793398R2 |
| 3 | Main Drive | 4 | 1408761R1 | A-1408761R1 |
| 4 | Jackshaft - Traction Drive | 1 | 3155178R1 | A-3155178R1 |
| 5 | Traction Variator Drive | 1 | 1409652R1 | A-1409652R1 |
| 6 | Return Auger - Fan Drive | 1 | 553456R2 | A-553456R2 |
| 7 | Tank Unloader Drive | 1 | 3155177R1 | A-3155177R1 |
| 8 | Return Auger Drive | 1 | 553456R2 | A-553456R2 |
| 9 | Return Elevator Drive | 1 | 790522R1 | A-790522R1 |
| 10 | Threshing Drum Variator drive | 1 | 3156220R92 | A-3156220R92 |
| 11 | Hydraulic Pump Drive | 1 | 769482R1 | A-769482R1 |

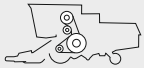

CASE INTL. HARVESTER 8-61-321

| Belt No. |  | No. of Belts | OEM  Part No. | PIX  Part No. |
|----------|---|--------------|--|--|
| 1 | Feeder Auger - Reel Variator drive | 1 | 1407123R1 | A-1407123R1 |
| 2 | Jackshaft - Platform Drive | 1 | 1408855R1 | A-1408855R1 |
| 2 | Jackshaft - Platform Drive | 1 | 1410279R1 | A-1410279R1 |
| 3 | Platform Drive | 1 | 3155127R1 | A-3155127R1 |
| 4 | Main Drive | 4 | 1408761R1 | A-1408761R1 |
| 5 | Jackshaft - Traction Drive | 1 | 1410106R1 | A-1410106R1 |
| 7 | Return Auger - Fan Drive | 1 | 1408840R1 | A-1408840R1 |
| 8 | Tank Unloader Drive | 1 | 1407324R1 | A-1407324R1 |
| 9 | Return Auger Drive | 1 | 553456R2 | A-553456R2 |
| 10 | Return Elevator Drive | 1 | 790522R1 | A-790522R1 |
| 11 | Threshing Drum Variator drive | 1 | 3156220R92 | A-3156220R92 |
| 12 | Hydraulic Pump Drive | 1 | 769482R1 | A-769482R1 |

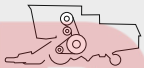

CASE INTL. HARVESTER 8-71-431

| Belt No. |  | No. of Belts | OEM  Part No. | PIX  Part No. |
|----------|---|--------------|--|--|
| 1 | Feeder Auger - Reel Variator Drive | 1 | 1407123R1 | A-1407123R1 |
| 2 | Jackshaft - Platform Drive | 1 | 1408855R1 | A-1408855R1 |
| 2 | Jackshaft - Platform Drive | 1 | 1410279R1 | A-1410279R1 |
| 3 | Platform Drive | 1 | 1410462R1 | A-1410462R1 |
| 4 | Main Drive | 4 | 1407035R1 | A-1407035R1 |
| 5 | Jackshaft - Traction Drive | 1 | 1410106R1 | A-1410106R1 |
| 7 | Return Auger - Fan drive | 1 | 1408840R1 | A-1408840R1 |
| 7 | Return Auger - Fan drive | 1 | 3158811R1 | A-3158811R1 |
| 8 | Tank Unloader Drive | 1 | 1407324R1 | A-1407324R1 |
| 9 | Return Auger Drive | 1 | 726278R1 | A-726278R1 |
| 10 | Return Elevator Drive | 1 | 790522R1 | A-790522R1 |
| 11 | Threshing Drum Variator Drive | 1 | 3156221R92 | A-3156221R92 |
| 12 | Hydraulic Pump Drive | 1 | 769482R1 | A-769482R1 |



CASE INTL. HARVESTER 8-91-531

| Belt No. |  | No. of Belts | OEM  Part No. | PIX  Part No. |
|----------|---|--------------|--|--|
| 1 | Feeder Auger - Reel Variator Drive | 1 | 1407123R1 | A-1407123R1 |
| 2 | Jackshaft - Platform Drive | 1 | 3158455R1 | A-3158455R1 |
| 3 | Platform Drive | 1 | 1410462R1 | A-1410462R1 |
| 4 | Main Drive | 4 | 1407035R1 | A-1407035R1 |
| 5 | Jackshaft - Traction Drive | 1 | 3157094R1 | A-3157094R1 |
| 7 | Return Auger - Fan drive | 1 | 3157600R1 | A-3157600R1 |
| 8 | Tank Unloader Drive | 1 | 3157994R1 | A-3157994R1 |
| 9 | Return Auger Drive | 1 | 726278R1 | A-726278R1 |
| 10 | Return Elevator Drive | 1 | 790522R1 | A-790522R1 |
| 11 | Threshing Drum Variator Drive | 1 | 3156221R92 | A-3156221R92 |
| 12 | Hydraulic Pump Drive | 1 | 3159827R1 | A-3159827R1 |

CASE INTL. HARVESTER 30

| Belt No. |  | No. of Belts | OEM  Part No. | PIX  Part No. |
|----------|---|--------------|--|--|
| 2 | Auger Drive (cross) (serial Nr. 8771 - ...) | 1 | 135462C1 | A-135462C1 |
| 3 | Auger Drive (side) | 1 | 452864R1 | A-452864R1 |
| 4 | Fan Drive (overhead Basket) | 1 | 662901R1 | A-662901R1 |
| 5 | Main Drive (left Hand) | 1 | 672177R1 | A-672177R1 |
| 6 | Main Drive (right Hand) | 1 | 672178R1 | A-672178R1 |



CASE INTL. HARVESTER 80

| Belt No. |  | No. of Belts | OEM  Part No. | PIX  Part No. |
|----------|---|--------------|--|--|
| 1 | Elevator Auger Drive (Two Used) | 1 | 565565R1 | A-565565R1 |
| 2 | Elevator Choke Indicator Drive | 1 | 209038C1 | A-209038C1 |
| 3 | Side Auger Drive (Two Used) | 1 | 668287R2 | A-668287R2 |
| 6 | Main Drive Farmall 656 Tractor 1000 (RH) | 1 | 158797C1 | A-158797C1 |
| 7 | Main Drive Farmall 400 450 460 560 (RH) | 1 | 191305C1 | A-191305C1 |



CASE INTL. HARVESTER 85

| Belt No. |  | No. of Belts | OEM  Part No. | PIX  Part No. |
|----------|---|--------------|--|--|
| 3 | Main Drive Farmall 700 800 900 Series (LH) | 1 | 200380C1 | A-200380C1 |
| 4 | Main Drive Farmall 700 800 900 Series (RH) | 1 | 200381C2 | A-200381C2 |
| 5 | Main Drive Farmall 656 Tractor 1000 (RH) | 1 | 158797C1 | A-158797C1 |
| 6 | Main Drive Farmall 400 450 460 560 (RH) | 1 | 191305C1 | A-191305C1 |
| 8 | Fan Drive | 1 | 672177R1 | A-672177R1 |

CASE INTL. HARVESTER 91

| Belt No. |  | No. of Belts | OEM  Part No. | PIX  Part No. |
|----------|---|--------------|--|--|
| 2 | Elevator Choke Indicator Drive | 1 | 209038C1 | A-209038C1 |
| 6 | Fan Drive | 1 | 672177R1 | A-672177R1 |

CASE INTL. HARVESTER 95



| Belt No. |  | No. of Belts | OEM  Part No. | PIX  Part No. |
|----------|---|--------------|--|--|
| 1 | Elevator Auger Drive (Two Used) | 1 | 209002C1 | A-209002C1 |
| 2 | Elevator Auger Counter Shaft | 1 | 160173C1 | A-160173C1 |
| 3 | Elevator Choke Indicator Drive | 1 | 209038C1 | A-209038C1 |
| 4 | Cross Auger Drive | 1 | 203651C1 | A-203651C1 |
| 5 | Counter Shaft - Cross Auger | 1 | 203644C1 | A-203644C1 |
| 6 | Finger Harvester Head Unit Drive | 1 | 559064R1 | A-559064R1 |
| 7 | Brush Roll Unit Gear Box Drive | 1 | 203658C1 | A-203658C1 |
| 8 | Auxiliary Drive Counter Shaft | 1 | 203612C1 | A-203612C1 |
| 10 | Alternator, Fan And Water Pump Drive | 1 | 59969C91 | A-59969C91 |

CASE INTL. HARVESTER



CASE INTL. HARVESTER 100 BALANCED

| Belt No. |  | No. of Belts | OEM  Part No. | PIX  Part No. |
|----------|---|--------------|--|--|
| 1 | Knife Drive (900 Rpm Pulley) 540 Rpm Tractor | 1 | 562088R1 | A-562088R1 |
| 3 | Knife Drive (1000 Rpm Pulley) | 1 | 558141R1 | A-558141R1 |

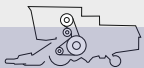

CASE INTL. HARVESTER 234

| Belt No. |  | No. of Belts | OEM  Part No. | PIX  Part No. |
|----------|---|--------------|--|--|
| 1 | Elevator Fan Drive | 1 | 937806R1 | A-937806R1 |
| 2 | Sheller Fan Drive (Serial Nr. 1991-2366) | 1 | 588894R1 | A-588894R1 |
| 3 | Sheller Fan Drive (Serial Nr. 1991-2366) | 1 | 23898K | A-23898K |

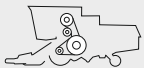

CASE INTL. HARVESTER 414 - 420

| Belt No. |  | No. of Belts | OEM  Part No. | PIX  Part No. |
|----------|--|--------------|--|--|
| 1 | Fan Drive | 1 | 666390R1 | A-666390R1 |
| 2 | Main Drive | 1 | 665970R1 | A-665970R1 |
| 3 | Alternator, Fan And Water Pump Drive | 1 | 274705R1 | A-274705R1 |
| 5 | Alternator, Fan And Water Pump Drive (420 Without Serial Nr. Ch1372f) | 1 | 403617R2 | A-403617R2 |
| 7 | Alternator, Fan And Water Pump Drive (420 Without Serial Nr. Ch1372f) | 1 | 379966R1 | A-379966R1 |

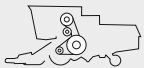

CASE INTL. HARVESTER 416 - 422

| Belt No. |  | No. of Belts | OEM  Part No. | PIX  Part No. |
|----------|---|--------------|--|--|
| 1 | Fan Drive | 1 | 666390R1 | A-666390R1 |
| 2 | Main Drive | 1 | 665970R1 | A-665970R1 |
| 3 | Alternator, Fan And Water Pump Drive | 1 | 403617R1 | A-403617R1 |
| 4 | Alternator, Fan And Water Pump Drive | 1 | 379966R2 | A-379966R2 |

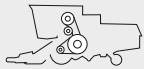

CASE INTL. HARVESTER 500 - 501

| Belt No. |  | No. of Belts | OEM  Part No. | PIX  Part No. |
|----------|---|--------------|--|--|
| 2 | Fan Drive Counter Shaft (Farmall 240 Tractor) | 1 | 665299R1 | A-665299R1 |
| 3 | Fan Drive (Single Fan) | 1 | 11466R | A-11466R |
| 6 | Tractors (Without Transmission Driven PTO) | 1 | 670144R1 | A-670144R1 |

CASE INTL. HARVESTER 502

| Belt No. |  | No. of Belts | OEM  Part No. | PIX  Part No. |
|----------|---|--------------|--|--|
| 1 | Main Drive (farmall Super M-ta.400.450) | 1 | 667068R1 | A-667068R1 |
| 2 | Main Drive (farmall 706. 806 Tractors) | 1 | 670282R1 | A-670282R1 |
| 3 | Fan Drive (Single Fan) | 1 | 11466R | A-11466R |
| 6 | Tractors (With Transmission Driven PTO) | 1 | 670144R1 | A-670144R1 |



CASE INTL. HARVESTER 616 - 622

| Belt No. |  | No. of Belts | OEM  Part No. | PIX  Part No. |
|----------|---|--------------|--|--|
| 1 | Drum Drive | 1 | 672974R2 | A-672974R2 |
| 3 | Fan Drive | 1 | 201092C1 | A-201092C1 |
| 4 | Alternator And Water Pump Drive | 1 | 397175R1 | A-397175R1 |
| 5 | Alternator And Water Pump Drive | 1 | 395539R1 | A-395539R1 |



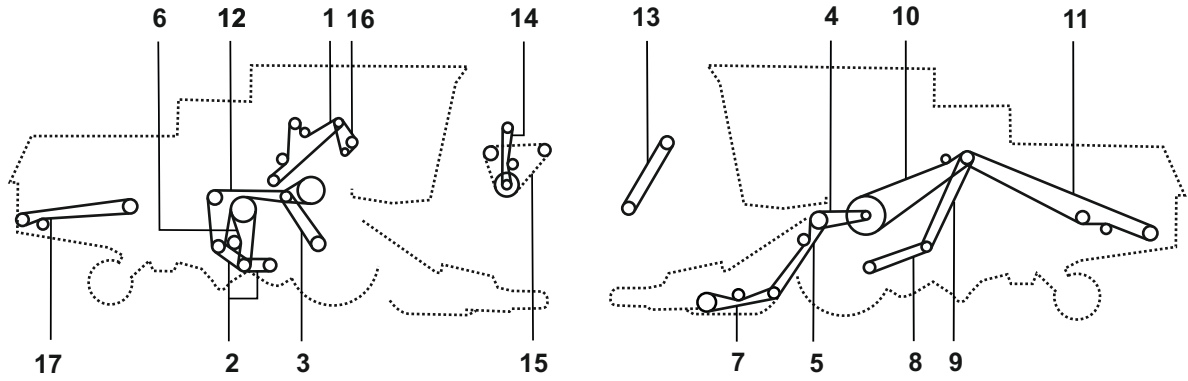

CASE INTL. HARVESTER 715





| Belt No. |  | No. of Belts | OEM  Part No. | PIX  Part No. |
|----------|---|--------------|--|--|
| 0 | Air Conditioning Compressor Drive | 1 | 936331R1 | A-936331R1 |
| 1 | Grain Tank Ext With Raised Levelling Auger | 1 | 150433C1 | A-150433C1 |
| 1 | Elevator Drive Without Raised Levelling Auger | 1 | 937928R1 | A-937928R1 |
| 1 | Elevator Drive With Raised Levelling Auger | 1 | 937929R1 | A-937929R1 |
| 2 | Fan Drive | 2 | 170954C11 | A-170954C11 |
| 3 | Shaker Shaft Drive | 1 | 188716C1 | A-188716C1 |
| 4 | Feeder Drive Regular | 1 | 937932R1 | A-937932R1 |
| 5 | Feeder Jackshaft Drive | 1 | 176566C1 | A-176566C1 |
| 5 | Feeder Jackshaft Drive X2 Rice Only | 1 | 176577C1 | A-176577C1 |
| 6 | Unloading Drive | 1 | 559064R1 | A-559064R1 |
| 6 | Hydrostatic Unloading Drive | 1 | 1656676C1 | A-1656676C1 |
| 7 | Auger and Knife Drive (112) | 1 | 191305C1 | A-191305C1 |
| 7 | Auger and Knife Drive (150) | 1 | 559064R1 | A-559064R1 |
| 7 | Auger and Knife Drive (102) | 1 | 178019C1 | A-178019C1 |
| 8 | Propulsion Drive | 1 | 173110C1 | A-173110C1 |
| 9 | Propulsion Jackshaft Drive | 1 | 150436C2 | A-150436C2 |
| 10 | Separator Drive | 1 | 171226C1 | A-171226C1 |
| 11 | Straw Chopper Drive | 1 | 174614C2 | A-174614C2 |
| 12 | Straw Walker - Fanjackshaft | 1 | 170948C1 | A-170948C1 |
| 13 | Hydrostatic Unloading Drive Jackshaft | 1 | 175545C1 | A-175545C1 |
| 13 | Unloading Jackshaft Drive | 1 | 179317C2 | A-179317C2 |
| 14 | Cylinder Drive Variable Speed (primary) | 1 | 171101C2 | A-171101C2 |
| 15 | Cylinder Drive Variable Speed | 1 | 171130C1 | A-171130C1 |
| 16 | Tailings Auger Drive | 1 | 627297R1 | A-627297R1 |
| 17 | Straw Spreaderdrive | 1 | 589622R1 | A-589622R1 |



CASE INTL. HARVESTER 730

| Belt No. |  | No. of Belts | OEM  Part No. | PIX  Part No. |
|----------|---|--------------|--|--|
| 1 | KNIFE DRIVE | 1 | 188716C1 | A-188716C1 |
| 3 | DRAPER COUNTER SHAFT DRIVE | 1 | 1336591C1 | A-1336591C1 |
| 4 | MAIN DRIVE | 1 | 1276589C1 | A-1276589C1 |
| 5 | DRAPER DRIVE WIDE OPENING | 1 | 617910R1 | A-617910R1 |
| 6 | DRAPER DRIVE NARROW OPENING | 1 | 1276707C1 | A-1276707C1 |

CASE INTL. HARVESTER 750



| Belt No. |  | No. of Belts | OEM  Part No. | PIX  Part No. |
|----------|---|--------------|--|--|
| 1 | KNIFE DRIVE | 1 | 188716C1 | A-188716C1 |
| 3 | REEL DRIVE (REAR) (PRIMARY) | 1 | 135594C1 | A-135594C1 |
| 4 | REEL DRIVE (FRONT) | 1 | 617910R1 | A-617910R1 |
| 5 | DRAPER COUNTERSHAFT DRIVE | 1 | 1336591C1 | A-1336591C1 |
| 6 | MAIN DRIVE | 1 | 1276589C1 | A-1276589C1 |
| 8 | MAIN DRIVE DUPLEX (REAR) | 1 | 1276634C1 | A-1276634C1 |
| 10 | DRAPER DRIVE NARROW OPENING | 1 | 1276707C1 | A-1276707C1 |
| 11 | DRAPER DRIVE RIGHT HAND (REAR) | 1 | 610521C1 | A-610521C1 |

CASE INTL. HARVESTER 782

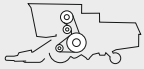

| Belt No. |  | No. of Belts | OEM  Part No. | PIX  Part No. |
|----------|---|--------------|--|--|
| 1 | DRUM DRIVE (2 USED) | 2 | 210185C1 | A-210185C1 |
| 2 | FAN DRIVE | 1 | 214522C1 | A-214522C1 |
| 4 | RADIATOR FAN DRIVE - ALTERNATOR | 1 | 130724C91 | A-130724C91 |
| 5 | AIR CONDITIONING COMPRESSOR DRIVE | 1 | 280210C2 | A-280210C2 |

CASE INTL. HARVESTER

CASE INTL. HARVESTER 810

| Belt No. |  | No. of Belts | OEM  Part No. | PIX  Part No. |
|----------|---|--------------|--|--|
| 1 | Knife Drive - 500 CPM For 30 Foot | 1 | 187415C2 | A-187415C2 |
| 2 | Knife Drive - 600 CPM Ref To 1300031 C91 | 1 | 552747R2 | A-552747R2 |
| 3 | Knife Drive - 500 CPM 103-25/32-inch OC | 1 | 178019C1 | A-178019C1 |
| 4 | Knife Drive - 600 CPM 20 Foot 600 mm Auger | 1 | 1319245C1 | A-1319245C1 |
| 6 | Knife Drive - Draper 150-3/8-inch | 1 | 559064R1 | A-559064R1 |



CASE INTL. HARVESTER 815

| Belt No. |  | No. of Belts | OEM  Part No. | PIX  Part No. |
|----------|---|--------------|--|--|
| 0 | Platform Jackshaft Drive Bolt Att. Feeder | 1 | 150816C1 | A-150816C1 |
| 0 | Rotary Air Screen Drive | 1 | 168725C1 | A-168725C1 |
| 0 | Rotary Air Screen Drive | 1 | 172360C1 | A-172360C1 |
| 0 | Feeder Fast Speed For Bolt Att. Feeder | 1 | 633728R2 | A-633728R2 |
| 1 | Compressor Drive (Diesel Engine) | 1 | 65337C2 | A-65337C2 |
| 2 | Cylinder Drive | 1 | 174509C1 | A-174509C1 |
| 3 | Feeder Jackshaft Drive | 1 | 176565C1 | A-176565C1 |
| 3 | Feeder Jackshaft Drive | 1 | 176566C1 | A-176566C1 |
| 3 | Feeder Jackshaft Drive | 1 | 176567C1 | A-176567C1 |
| 4 | Hydraulic Reel Pump Drive (Gas Engine) | 1 | 178763C1 | A-178763C1 |
| 5 | Knife Drive | 1 | 178019C1 | A-178019C1 |
| 6 | Separator Drive (Gas Engine) | 1 | 166598C2 | A-166598C2 |
| 6 | Separator Drive (Diesel Engine) | 1 | 168665C2 | A-168665C2 |
| 7 | Shaker Shaft Drive 265 Rpm | 1 | 564494R2 | A-564494R2 |
| 8 | Straw Chopper Drive | 1 | 160870C1 | A-160870C1 |
| 8 | Straw Chopper Drive | 1 | 174642C1 | A-174642C1 |
| 8 | Straw Chopper Drive | 1 | 177499C1 | A-177499C1 |
| 9 | Straw Spreader Drive | 1 | 161820C1 | A-161820C1 |
| 9 | Straw Spreader Drive | 1 | 161821C1 | A-161821C1 |
| 9 | Straw Spreader Drive | 1 | 196370C1 | A-196370C1 |
| 10 | Unloading Jackshaft Drive | 1 | 160173C1 | A-160173C1 |
| 11 | Cylinder Drive Variable Speed | 1 | 164006C1 | A-164006C1 |
| 12 | Alternator, Fan And Water Pump (DSL Only) | 1 | 528419R91 | A-528419R91 |
| 12 | Alternator, Fan And Water pump (with 414 Engine) | 2 | 537072R92 | A-537072R92 |
| 13 | Separator Fan Drive | 1 | 164999C2 | A-164999C2 |
| 14 | Compressor Drive (Gas Engine) | 1 | 167031C2 | A-167031C2 |
| 15 | Alternator, Fan And Water Pump Drive | 1 | 402253R91 | A-402253R91 |
| 16 | Governor Drive | 1 | 532031R2 | A-532031R2 |

CASE INTL. HARVESTER 815 GAS

| Belt No. |  | No. of Belts | OEM  Part No. | PIX  Part No. |
|----------|---|--------------|--|--|
| 1 | Straw Chopper Jackshaft Drive | 1 | 160871C1 | A-160871C1 |
| 2 | Rotary Air Screen Drive | 1 | 38331K | A-38331K |



CASE INTL. HARVESTER 820

| Belt No. |  | No. of Belts | OEM  Part No. | PIX  Part No. |
|----------|---|--------------|--|--|
| 1 | Drive 112-13/64-inch | 1 | 191305C1 | A-191305C1 |



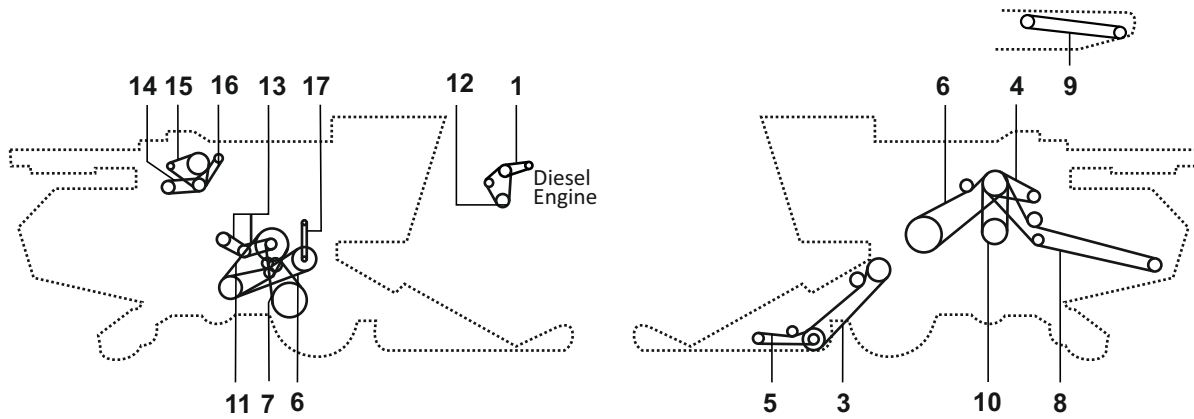

CASE INTL. HARVESTER 915



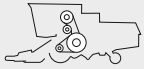

| Belt No. |  | No. of Belts | OEM  Part No. | PIX  Part No. |
|----------|---|--------------|--|--|
| 0 | Straw Chopper Jackshaft Drive | 1 | 160871C1 | A-160871C1 |
| 0 | Rotary Air Screen Drive | 1 | 168725C1 | A-168725C1 |
| 0 | Rotary Air Screen Drive | 1 | 172360C1 | A-172360C1 |
| 0 | Rotary Air Screen Drive | 1 | 38331K | A-38331K |
| 0 | Feeder Fast Speed Forbolt Att. Feeder | 1 | 633728R2 | A-633728R2 |
| 2 | Cylinder Drive | 1 | 174509C1 | A-174509C1 |
| 3 | Feeder Jackshaft Drive | 1 | 176565C1 | A-176565C1 |
| 3 | Feeder Jackshaft Drive | 1 | 176566C1 | A-176566C1 |
| 3 | Feeder Jackshaft Drive | 1 | 176567C1 | A-176567C1 |
| 3 | Feeder Jackshaft Drive | 1 | 176576C1 | A-176576C1 |
| 3 | Feeder Jackshaft Drive | 1 | 176577C1 | A-176577C1 |
| 4 | Hydraulic Reel Pump Drive (diesel Engine) | 1 | 179007C1 | A-179007C1 |
| 5 | Knife Drive | 1 | 178019C1 | A-178019C1 |
| 6 | Separator Drive (gas Engine) | 1 | 166598C2 | A-166598C2 |
| 6 | Separator Drive (diesel Engine) | 1 | 168665C2 | A-168665C2 |
| 7 | Shaker Shaft Drive 265 Rpm | 1 | 564494R2 | A-564494R2 |
| 7 | Shaker Shaft Drive 280 Rpm | 1 | 632702R1 | A-632702R1 |
| 8 | Straw Chopper Drive | 1 | 160870C1 | A-160870C1 |
| 8 | Straw Chopper Drive | 1 | 174642C1 | A-174642C1 |
| 8 | Straw Chopper Drive | 1 | 177499C1 | A-177499C1 |
| 9 | Straw Spreader Drive | 1 | 196371C1 | A-196371C1 |
| 9 | Straw Spreader Drive | 1 | 161821C1 | A-161821C1 |
| 10 | Unloading Jackshaft Drive | 1 | 160173C1 | A-160173C1 |
| 11 | Cylinder Drive Variable Speed | 1 | 164006C1 | A-164006C1 |
| 12 | Alternator, Fan and Waterpump (diesel Only) | 1 | 528419R91 | A-528419R91 |
| 12 | Alternator, Fan and Waterpump (without 414 Engine) | 2 | 537072R92 | A-537072R92 |
| 13 | Separator Fan drive | 1 | 164999C92 | A-164999C92 |
| 15 | Alternator, Fan and Waterpump Drive (without Air Compressor) | 1 | 402253R91 | A-402253R91 |
| 16 | Governor Drive | 1 | 532031R2 | A-532031R2 |



CASE INTL. HARVESTER 923

| Belt No. |  | No. of Belts | OEM  Part No. | PIX  Part No. |
|----------|---|--------------|--|--|
| 4 | AUGER DRIVE (UPPER) | 1 | 726278R1 | A-726278R1 |
| 5 | UNLOADING JACKSHAFT DRIVE | 1 | 3175336R1 | A-3175336R1 |
| 6 | CYLINDER | 1 | 3175110R1 | A-3175110R1 |
| 9 | TRACTION (UPPER) | 1 | 3157738R1 | A-3157738R1 |
| 12 | FAN - RETURN | 1 | 3176321R1 | A-3176321R1 |
| 13 | FEEDER - JACKSHAFT | 1 | 3175432R1 | A-3175432R1 |

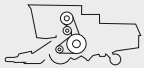

CASE INTL. HARVESTER 933

| Belt No. |  | No. of Belts | OEM  Part No. | PIX  Part No. |
|----------|---|--------------|--|--|
| 4 | AUGER DRIVE (UPPER) | 1 | 726278R1 | A-726278R1 |
| 5 | UNLOADING JACKSHAFT DRIVE | 1 | 3157994R1 | A-3157994R1 |
| 6 | CYLINDER | 1 | 3175110R1 | A-3175110R1 |
| 8 | FEEDER - PLATFORM | 1 | 3157741R1 | A-3157741R1 |
| 9 | TRACTION (UPPER) | 1 | 3157094R1 | A-3157094R1 |
| 12 | FAN - RETURN | 1 | 3176321R1 | A-3176321R1 |
| 13 | FEEDER - JACKSHAFT | 1 | 3173480R1 | A-3173480R1 |

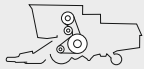

CASE INTL. HARVESTER 943

| Belt No. |  | No. of Belts | OEM  Part No. | PIX  Part No. |
|----------|---|--------------|--|--|
| 1 | Intermediate Shaft | 1 | 790522R1 | A-790522R1 |
| 4 | Auger Drive (Upper) | 1 | 726278R1 | A-726278R1 |
| 5 | Cylinder | 1 | 3168030R3 | A-3168030R3 |
| 6 | Separator Drive | 1 | 1407123R1 | A-1407123R1 |
| 7 | Return Elevator Drive | 1 | 1408855R1 | A-1408855R1 |
| 8 | Counter Shaft Drive | 1 | 3168669R1 | A-3168669R1 |
| 9 | Discharge Auger Shaft | 1 | 3167361R1 | A-3167361R1 |
| 10 | Cutting Table Drive | 1 | 3173115R1 | A-3173115R1 |
| 11 | Feeder - Platform | 1 | 3167149R1 | A-3167149R1 |
| 12 | Traction Drive | 1 | 3173717R1 | A-3173717R1 |
| 15 | Feeder - Jackshaft | 2 | 3173164R1 | A-3173164R1 |
| 17 | Return Auger - Shaker | 1 | 3176489R1 | A-3176489R1 |
| 18 | Reel Drive Variable Speed | 1 | 1407123R1 | A-1407123R1 |

CASE INTL. HARVESTER 953

| Belt No. |  | No. of Belts | OEM  Part No. | PIX  Part No. |
|----------|---|--------------|--|--|
| 1 | REEL DRIVE VARIABLE SPEED | 1 | 1407123R1 | A-1407123R1 |
| 2 | CUTTING TABLE DRIVE | 1 | 3167797R1 | A-3167797R1 |
| 3 | CUTTING TABLE DRIVE | 1 | 3167149R1 | A-3167149R1 |
| 4 | MAIN DRIVE | 1 | 3167653R2 | A-3167653R2 |
| 5 | DISCHARGE AUGER SHAFT | 1 | 3167361R2 | A-3167361R2 |
| 6 | VARIATOR DRIVE | 1 | 3167189R1 | A-3167189R1 |
| 7 | VARIATOR DRIVE | 1 | 3167189R1 | A-3167189R1 |
| 8 | RETURN AUGER - SHAKER | 1 | 3167489R1 | A-3167489R1 |
| 9 | ROTARY DRIVE | 1 | 726285R1 | A-726285R1 |
| 11 | RETURN ELEVATOR DRIVE | 1 | 3170210R1 | A-3170210R1 |
| 12 | RETURN AUGER ABOVE CYLINDER | 1 | 3170159R1 | A-3170159R1 |
| 13 | INTERMEDIATE SHAFT | 1 | 790522R1 | A-790522R1 |
| 14 | CYLINDER | 1 | 3168030R2 | A-3168030R2 |
| 15 | COUNTERSHAFT DRIVE | 1 | 3168669R1 | A-3168669R1 |
| 16 | FAN DRIVE | 1 | 1407123R1 | A-1407123R1 |





| Belt No. |  | No. of Belts | OEM  Part No. | PIX  Part No. |
|----------|---|--------------|--|--|
| 1 | Unit Main Drive | 1 | 217636C1 | A-217636C1 |
| 3 | Fan Drive | 1 | 217564C1 | A-217564C1 |
| 6 | Cross Auger Drive 30.32.34 Inch 4-row | 1 | 203170C1 | A-203170C1 |
| 13 | Center Unit Drive 36-.38- and 40-inch | 1 | 217698C1 | A-217698C1 |
| 15 | Outer Unit Drive 30.32.34 Inch 4-row | 1 | 217701C1 | A-217701C1 |
| 16 | Outer Unit Drive 36.38.40 Inch 4-row | 1 | 217699C1 | A-217699C1 |
| 17 | Outer Unit Drive 30-inch 4-row | 1 | 217702C1 | A-217702C1 |
| 19 | Outer Unit Drive 36.38.40 Inch 4-row | 1 | 217700C1 | A-217700C1 |
| 23 | Outer Unit Drive 30-inch 4-row (1 Used) | 1 | 217702C1 | A-217702C1 |
| 24 | Outer Unit Drive 30-inch 4-row (1 Used) | 3 | 217703C1 | A-217703C1 |
| 32 | Alternator, Fan and Water pump Drive | 1 | 130724C91 | A-130724C91 |
| 33 | Air Conditioning Compressor Drive | 1 | 280210C2 | A-280210C2 |



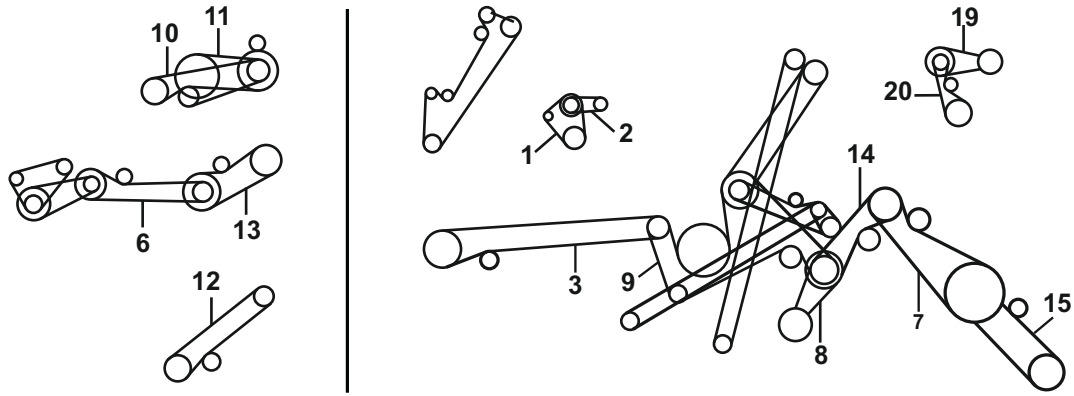



CASE INTL. HARVESTER 1400 US EDITION (... - 20715)



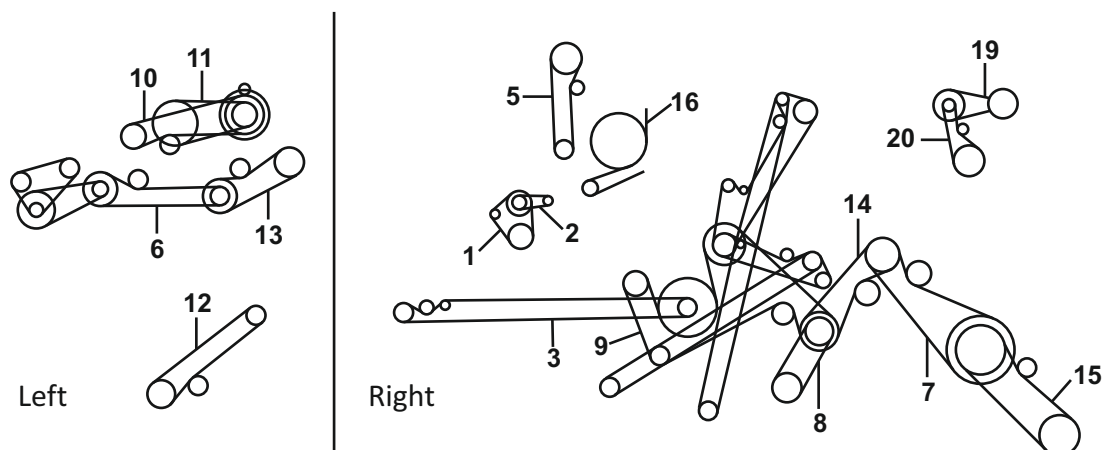

| Belt No. |  | No. of Belts | OEM  Part No. | PIX  Part No. |
|----------|---|--------------|--|--|
| 1 | Alternator, Fan and Waterpump Drive | 2 | 537072R92 | A-537072R92 |
| 2 | Air Conditioning Compressor Drive | 1 | 874097C1 | A-874097C1 |
| 3 | Straw Spreader Drive | 1 | 153359C1 | A-153359C1 |
| 6 | Unloading Auger Drive | 1 | 191290C1 | A-191290C1 |
| 7 | Feeder Drive | 1 | 192738C1 | A-192738C1 |
| 8 | Cleaning Fandrive | 1 | 195396C2 | A-195396C2 |
| 9 | Elevator Drive Unit | 1 | 186509C2 | A-186509C2 |
| 9 | Elevator Drive Unit | 1 | 192360C1 | A-192360C1 |
| 10 | Separator Drive | 1 | 191241C3 | A-191241C3 |
| 11 | Rotor Variator Drive | 1 | 244420A1 | A-244420A1 |
| 12 | Reel Drive Pump | 1 | 197414C2 | A-197414C2 |
| 12 | Reel Drive Pump | 1 | 1315315C1 | A-1315315C1 |
| 13 | Auxiliary Pump Drive | 1 | 191288C3 | A-191288C3 |
| 14 | Fan Jackshaft Drive | 1 | 191305C1 | A-191305C1 |
| 15 | Feeder Jackshaft Drive | 1 | 1313095C2 | A-1313095C2 |
| 15 | Feeder Jackshaft Drive | 1 | 1313097C3 | A-1313097C3 |
| 19 | Fan Jackshaft Drive | 1 | 181359C1 | A-181359C1 |
| 20 | Fan Jackshaft Slow Speed | 1 | 610521R1 | A-610521R1 |

CASE INTL. HARVESTER 1400 US EDITION (20715 -...)1440E



| Belt No. |  | No. of Belts | OEM  Part No. | PIX  Part No. |
|----------|---|--------------|--|--|
| 1 | ALTERNATOR, FAN and WATERPUMP DRIVE | 2 | 537072R92 | A-537072R92 |
| 2 | AIR CONDITIONING COMPRESSOR DRIVE | 1 | 874097C1 | A-874097C1 |
| 3 | STRAW SPREADER DRIVE | 1 | 196371C1 | A-196371C1 |
| 5 | STRAW CHOPPER DRIVE | 1 | 181012C1 | A-181012C1 |
| 6 | UNLOADING AUGER DRIVE | 1 | 191290C1 | A-191290C1 |
| 7 | FEEDER DRIVE | 1 | 192738C1 | A-192738C1 |
| 8 | CLEANING FAN DRIVE | 1 | 195396C2 | A-195396C2 |
| 9 | ELEVATOR DRIVE UNIT | 1 | 186509C2 | A-186509C2 |
| 10 | SEPARATOR DRIVE | 1 | 191241C3 | A-191241C3 |
| 11 | ROTOR VARIATOR DRIVE | 1 | 244420A1 | A-244420A1 |
| 12 | REEL DRIVE PUMP WITHOUT ROCK TRAP | 1 | 197414C2 | A-197414C2 |
| 12 | REEL DRIVE PUMP WITH ROCK TRAP | 1 | 1315315C1 | A-1315315C1 |
| 12 | REEL DRIVE PUMP WITHOUT ROCK TRAP | 1 | 197411C1 | A-197411C1 |
| 13 | AUXILIARY PUMP DRIVE | 1 | 191288C3 | A-191288C3 |
| 14 | FAN JACKSHAFT DRIVE | 1 | 191305C1 | A-191305C1 |
| 15 | FEEDER JACKSHAFT DRIVE | 1 | 1313095C2 | A-1313095C2 |
| 15 | FEEDER JACKSHAFT DRIVE | 1 | 1313097C3 | A-1313097C3 |
| 16 | CLEANING UNIT DRIVE WITH STRAW CHOPPER | 1 | 181055C1 | A-181055C1 |
| 19 | FAN JACKSHAFT DRIVE | 1 | 181359C1 | A-181359C1 |
| 20 | FAN JACKSHAFT SLOW SPEED | 1 | 610521R1 | A-610521R1 |

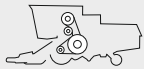

CASE INTL. HARVESTER 1420

| Belt No. |  | No. of Belts | OEM  Part No. | PIX  Part No. |
|----------|---|--------------|--|--|
| 1 | FAN, ALTERNATOR, WATER PUMP | 2 | 130724C91 | A-130724C91 |
| 2 | COMPRESSOR DRIVE | 1 | 280210C2 | A-280210C2 |
| 3 | STRAW SPREADER DRIVE | 1 | 589622R1 | A-589622R1 |
| 4 | RH SIDE DRIVE W/ DISCHARGE BEATER | 1 | 183049C1 | A-183049C1 |
| 4 | RH SIDE DRIVE W/ STRAW CHOPPER | 1 | 186509C2 | A-186509C2 |
| 5 | FAN DRIVE | 1 | 599060R1 | A-599060R1 |
| 6 | FEEDER DRIVE | 1 | 186377C1 | A-186377C1 |
| 7 | FEEDER JACKSHAFT DRIVE | 1 | 197412C1 | A-197412C1 |
| 8 | GRAIN ELEVATOR, GRAIN/CORN | 1 | 182619C1 | A-182619C1 |
| 9 | TAILINGS ELEV. DRIVE | 1 | 674965R1 | A-674965R1 |
| 10 | STRAW CHOPPER DRIVE | 1 | 182945C1 | A-182945C1 |
| 11 | FEEDER JACKSHAFT DRIVE | 1 | 197414C2 | A-197414C2 |
| 12 | UNLOADER JACKSHAFT DRIVE | 1 | 195143C1 | A-195143C1 |
| 13 | AUXILIARY PUMP DRIVE | 1 | 191288C2 | A-191288C2 |
| 14 | SEPARATOR DRIVE | 1 | 191241C2 | A-191241C2 |
| 15 | ROTOR VARIABLE DRIVE | 1 | 1302174C1 | A-1302174C1 |



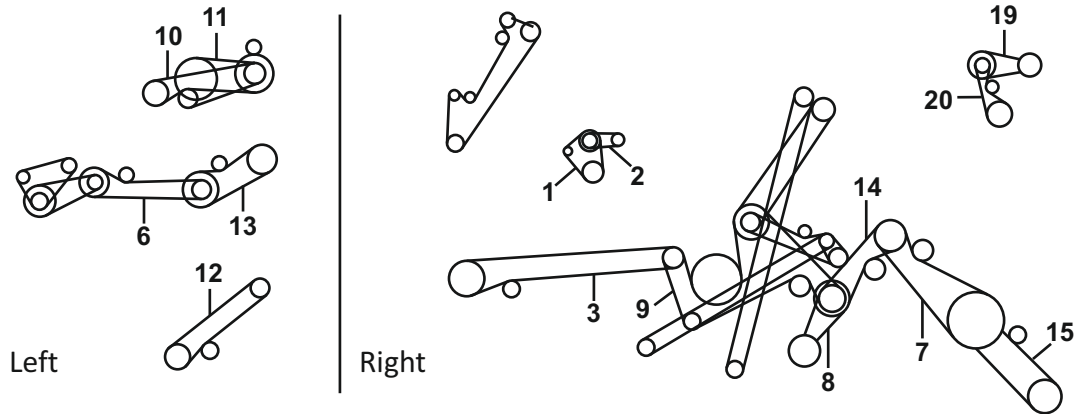



CASE INTL. HARVESTER 1460 - US EDITION (23247 - ...)

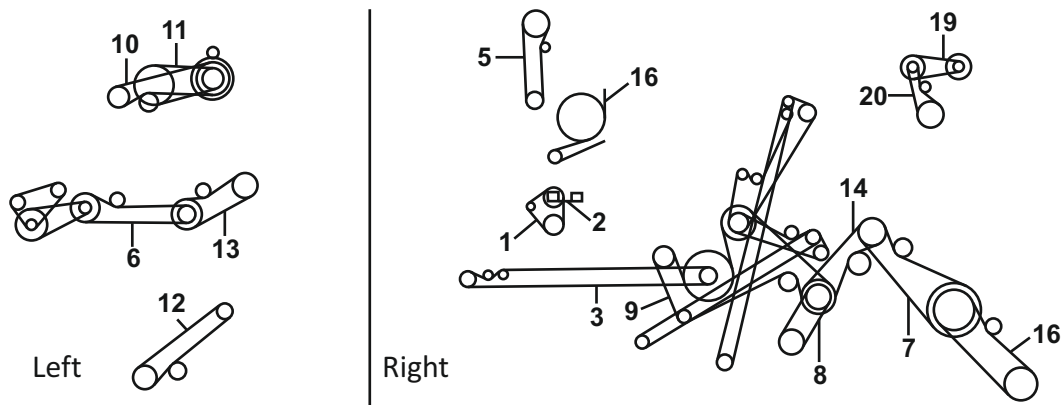

| Belt No. |  | No. of Belts | OEM  Part No. | PIX  Part No. |
|----------|---|--------------|--|--|
| 1 | Alternator, Fan and Waterpump Drive | 2 | 537072R92 | A-537072R92 |
| 2 | Air Conditioning Compressor Drive | 1 | 874097C1 | A-874097C1 |
| 3 | Straw Spreader Drive | 1 | 153359C1 | A-153359C1 |
| 6 | Unloading Auger Drive | 1 | 191290C1 | A-191290C1 |
| 7 | Feeder Drive | 1 | 192738C1 | A-192738C1 |
| 8 | Cleaning Fan Drive | 1 | 195396C2 | A-195396C2 |
| 9 | Elevator Drive Unit | 1 | 186509C2 | A-186509C2 |
| 9 | Elevator Drive Unit | 1 | 192360C1 | A-192360C1 |
| 10 | Separator Drive | 1 | 191241C3 | A-191241C3 |
| 11 | Rotor Variator Drive | 1 | 244420A1 | A-244420A1 |
| 12 | Reel Drive Pump Without Rock Trap | 1 | 197414C2 | A-197414C2 |
| 12 | Reel Drive Pump With Rock Trap | 1 | 1315315C1 | A-1315315C1 |
| 13 | Auxiliary Pump Drive | 1 | 191288C3 | A-191288C3 |
| 14 | Fan Jackshaft Drive | 1 | 191305C1 | A-191305C1 |
| 15 | Feeder Jackshaft Drive | 1 | 1313095C2 | A-1313095C2 |
| 15 | Feeder Jackshaft Drive | 1 | 1313097C3 | A-1313097C3 |
| 19 | Fan Jackshaft Drive | 1 | 181359C1 | A-181359C1 |
| 20 | Fan Jackshaft Slow Speed | 1 | 610521R1 | A-610521R1 |



CASE INTL. HARVESTER 1460 US EDITION (23250- ...)1460E



| Belt No. |  | No. of Belts | OEM  Part No. | PIX  Part No. |
|----------|---|--------------|--|--|
| 1 | Alternator, Fan and Waterpump Drive | 2 | 537072R92 | A-537072R92 |
| 2 | Air Conditioning Compressor Drive | 1 | 874097C1 | A-874097C1 |
| 3 | Straw Spreader Drive | 1 | 196371C1 | A-196371C1 |
| 5 | Straw Chopper Drive | 1 | 181012C1 | A-181012C1 |
| 6 | Unloading Auger Drive | 1 | 191290C1 | A-191290C1 |
| 7 | Feeder Drive | 1 | 192738C1 | A-192738C1 |
| 8 | Cleaning Fandrive | 1 | 195396C2 | A-195396C2 |
| 9 | Elevator Drive Unit | 1 | 186509C2 | A-186509C2 |
| 10 | Separator Drive | 1 | 191241C3 | A-191241C3 |
| 11 | Rotor Variator Drive | 1 | 244420A1 | A-244420A1 |
| 12 | Reel Drive Pump Without Rocktrap | 1 | 197414C2 | A-197414C2 |
| 12 | Reel Drive Pump With Rock Trap | 1 | 1315315C1 | A-1315315C1 |
| 12 | Reel Drive Pump Without Rocktrap | 1 | 197411C1 | A-197411C1 |
| 13 | Auxiliary Pump Drive | 1 | 191288C3 | A-191288C3 |
| 14 | Fan Jackshaft Drive | 1 | 191305C1 | A-191305C1 |
| 15 | Feeder Jackshaft Drive | 1 | 1313095C2 | A-1313095C2 |
| 15 | Feeder Jackshaft Drive | 1 | 1313097C3 | A-1313097C3 |
| 16 | Cleaning Unit Drive With Straw Chopper | 1 | 181055C1 | A-181055C1 |
| 19 | Fan Jackshaft Drive | 1 | 181359C1 | A-181359C1 |
| 20 | Fan Jackshaft Slow Speed | 1 | 610521R1 | A-610521R1 |

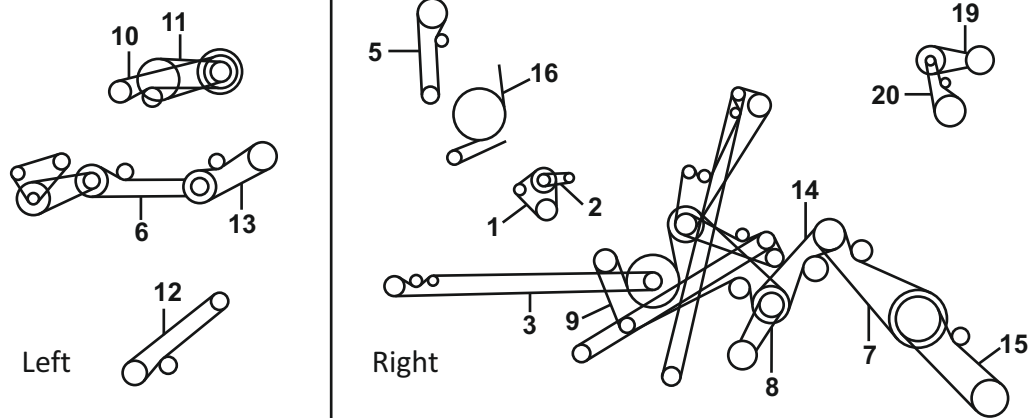

CASE INTL. HARVESTER 1480 - US EDITION (24000 - ...)





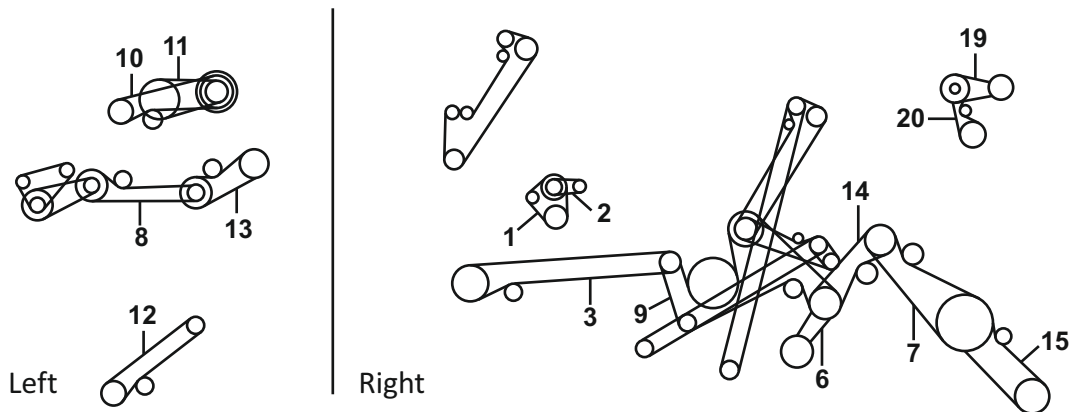

| Belt No. |  | No. of Belts | OEM  Part No. | PIX  Part No. |
|----------|---|--------------|--|--|
| 1 | Alternator, Fan and Waterpump Drive | 2 | 537072R92 | A-537072R92 |
| 2 | Air Conditioning Compressor Drive | 1 | 874097C1 | A-874097C1 |
| 3 | Straw Spreader Drive | 1 | 196371C1 | A-196371C1 |
| 5 | Straw Chopper Drive | 1 | 181013C1 | A-181013C1 |
| 6 | Unloading Auger Drive | 1 | 191291C1 | A-191291C1 |
| 7 | Feeder Drive | 1 | 194528C1 | A-194528C1 |
| 8 | Cleaning Fan Drive | 1 | 195396C2 | A-195396C2 |
| 9 | Elevator Drive Unit | 1 | 186509C2 | A-186509C2 |
| 10 | Separator Drive | 1 | 191244C1 | A-191244C1 |
| 11 | Rotor Variator Drive | 1 | 244422A1 | A-244422A1 |
| 12 | Reel Drive Pump | 1 | 197414C2 | A-197414C2 |
| 12 | Reel Drive Pump | 1 | 197480C2 | A-197480C2 |
| 13 | Auxiliary Pump Drive | 1 | 191288C3 | A-191288C3 |
| 14 | Fan Jackshaft Drive | 1 | 188213C1 | A-188213C1 |
| 15 | Feeder Jackshaft Drive | 1 | 1313097C3 | A-1313097C3 |
| 15 | Feeder Jackshaft Drive | 1 | 1308489C2 | A-1308489C2 |
| 16 | Cleaning Unit Drive With Straw Chopper | 1 | 181055C1 | A-181055C1 |
| 19 | Fan Jackshaft Drive | 1 | 181359C1 | A-181359C1 |
| 20 | Fan Jackshaft Slow Speed | 1 | 610521R1 | A-610521R1 |

CASE INTL. HARVESTER 1480 - US EDITION (... - 24000)

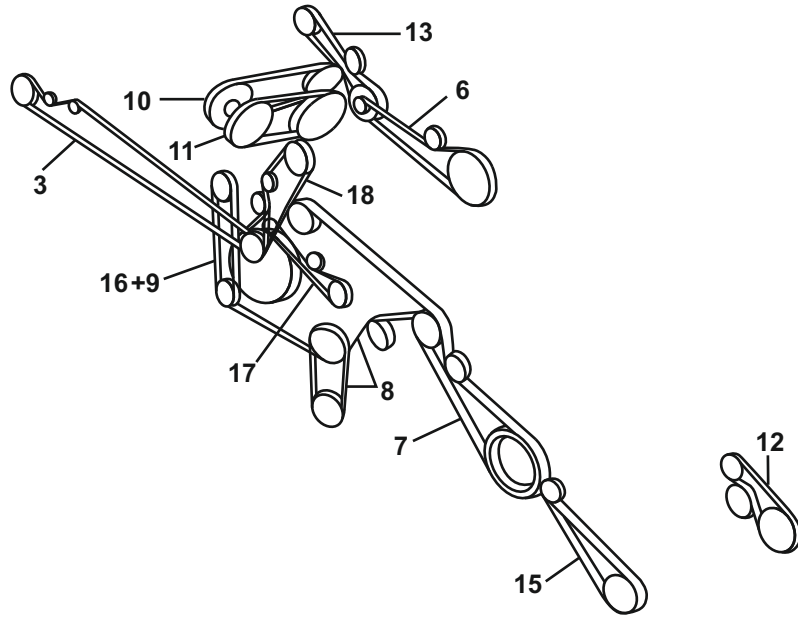





| Belt No. |  | No. of Belts | OEM  Part No. | PIX  Part No. |
|----------|---|--------------|--|--|
| 1 | Alternator, Fan and Waterpump Drive | 2 | 537072R92 | A-537072R92 |
| 2 | Air Conditioning Compressor Drive | 1 | 874097C1 | A-874097C1 |
| 3 | Straw Spreader Drive | 1 | 153359C1 | A-153359C1 |
| 6 | Unloading Auger Drive | 1 | 191291C1 | A-191291C1 |
| 7 | Feeder Drive | 1 | 194528C1 | A-194528C1 |
| 8 | Cleaning Fandrive | 1 | 195396C2 | A-195396C2 |
| 9 | Elevator Drive Unit | 1 | 186509C2 | A-186509C2 |
| 10 | Separator Drive | 1 | 191244C1 | A-191244C1 |
| 11 | Rotor Variatordrive | 1 | 244422A1 | A-244422A1 |
| 12 | Reel Drive Pump Without Rocktrap | 1 | 197414C2 | A-197414C2 |
| 12 | Reel Drive Pump With Rock Trap | 1 | 197480C2 | A-197480C2 |
| 13 | Auxiliary Pump Drive | 1 | 191288C3 | A-191288C3 |
| 14 | Fan Jackshaft Drive | 1 | 188213C1 | A-188213C1 |
| 15 | Feeder Jackshaft Drive | 1 | 1313097C3 | A-1313097C3 |
| 15 | Feeder Jackshaft Drive | 1 | 1308489C2 | A-1308489C2 |
| 19 | Fan Jackshaft Drive | 1 | 181359C1 | A-181359C1 |
| 20 | Fan Jackshaft Slow Speed | 1 | 610521R1 | A-610521R1 |

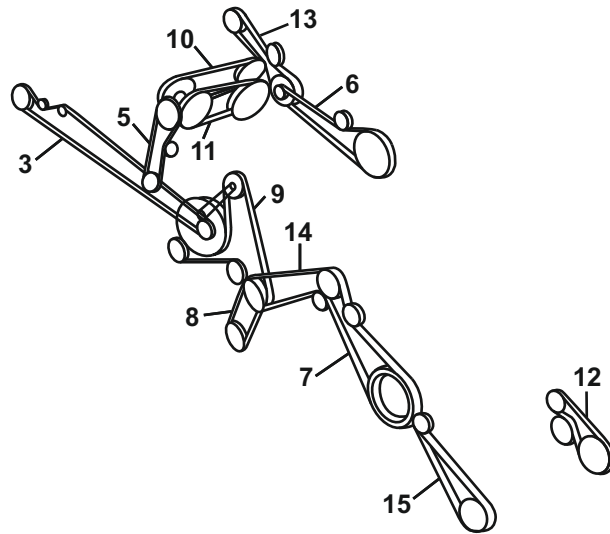

| Belt No. |  | No. of Belts | OEM  Part No. | PIX  Part No. |
|----------|---|--------------|--|--|
| 1 | Alternator, Fan and Waterpump Drive | 1 | 130724C91 | A-130724C91 |
| 2 | Air Conditioning Compressor Drive | 1 | 280210C2 | A-280210C2 |
| 2 | Air Conditioning Compressor Drive | 1 | 874097C1 | A-874097C1 |
| 3 | Straw Spreader Drive | 1 | 589622R1 | A-589622R1 |
| 5 | Straw Chopper Drive | 1 | 182945C1 | A-182945C1 |
| 6 | Unloading Auger Drive | 1 | 195143C1 | A-195143C1 |
| 7 | Feeder Drive | 1 | 186509C2 | A-186509C2 |
| 7 | Feeder Drive | 1 | 186377C1 | A-186377C1 |
| 8 | Cleaning Fan Drive | 1 | 599060R1 | A-599060R1 |
| 9 | Elevator Drive Unit | 1 | 183049C1 | A-183049C1 |
| 10 | Separator Drive | 1 | 191241C3 | A-191241C3 |
| 11 | Rotor Variator Drive | 1 | 1302174C1 | A-1302174C1 |
| 12 | Reel Drive Pump | 1 | 197414C2 | A-197414C2 |
| 13 | Auxiliary Pump Drive | 1 | 191288C3 | A-191288C3 |
| 15 | Feeder Jackshaft Drive | 1 | 197412C1 | A-197412C1 |
| 16 | Cleaning Unit Drive With Straw Chopper | 1 | 186509C2 | A-186509C2 |
| 18 | Elevator Drive Grain | 1 | 182619C1 | A-182619C1 |
| 18 | Elevator Drive Grain | 1 | 181433C1 | A-181433C1 |



CASE INTL. HARVESTER 1640 (ENGINE DT436B)



| Belt No. |  | No. of Belts | OEM  Part No. | PIX  Part No. |
|----------|---|--------------|--|--|
| 1 | Alternator, Fan and Waterpump Drive | 2 | 537072R92 | A-537072R92 |
| 2 | Air Conditioning Compressor Drive | 1 | 164550R2 | A-164550R2 |
| 3 | Straw Spreader Drive | 1 | 196371C1 | A-196371C1 |
| 5 | Straw Chopper Drive | 1 | 1315265C1 | A-1315265C1 |
| 6 | Unloading Auger Drive | 1 | 191290C1 | A-191290C1 |
| 7 | Feeder Drive Without Rocktrap | 1 | 192738C1 | A-192738C1 |
| 7 | Feeder Drive With Rock Trap | 1 | 1315168C1 | A-1315168C1 |
| 8 | Cleaning Fandrive | 1 | 195396C2 | A-195396C2 |
| 9 | Elevator Drive Unit | 1 | 181055C1 | A-181055C1 |
| 10 | Separator Drive | 1 | 191241C3 | A-191241C3 |
| 11 | Rotor Variator drive | 1 | 244420A1 | A-244420A1 |
| 12 | Reel Drive Pump | 1 | 1321564C2 | A-1321564C2 |
| 12 | Reel Drive Pump | 1 | 1321565C1 | A-1321565C1 |
| 13 | Auxiliary Pump Drive | 1 | 191288C3 | A-191288C3 |
| 14 | Fan Jackshaft Drive | 1 | 191305C1 | A-191305C1 |
| 15 | Feeder Jackshaft Drive | 1 | 1313095C2 | A-1313095C2 |
| 15 | Feeder Jackshaft Drive | 1 | 1313097C3 | A-1313097C3 |
| 19 | Fan Jackshaft Drive | 1 | 181359C1 | A-181359C1 |
| 20 | Fan Jackshaft Slow Speed | 1 | 610521R1 | A-610521R1 |

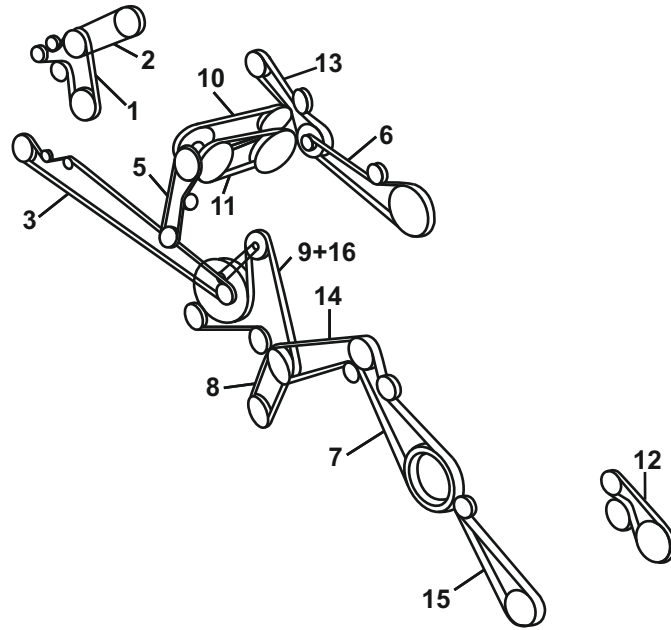

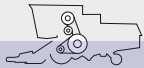
CASE INTL. HARVESTER 1640 (ENGINE NCE)



| Belt No. |  | No. of Belts | OEM  Part No. | PIX  Part No. |
|----------|---|--------------|--|--|
| 1 | Alternator, Fan and Waterpump Drive | 1 | J911562 | A-J911562 |
| 2 | Air Conditioning Compressor Drive | 1 | L72739 | A-L72739 |
| 3 | Straw Spreader Drive | 1 | 196371 | A-196371 |
| 5 | Straw Chopper Drive | 1 | 1347157C1 | A-1347157C1 |
| 6 | Unloading Auger Drive | 1 | 191290C1 | A-191290C1 |
| 6 | Unloading Auger Drive | 1 | 1989216C1 | A-1989216C1 |
| 7 | Feeder Drive Without Rock Trap | 1 | 192738C1 | A-192738C1 |
| 7 | Feeder Drive With Rock Trap | 1 | 1315168C1 | A-1315168C1 |
| 8 | Cleaning Fan Drive | 1 | 195396C2 | A-195396C2 |
| 9 | Elevator Drive Unit | 1 | 186509C2 | A-186509C2 |
| 10 | Separator Drive | 1 | 191241C3 | A-191241C3 |
| 11 | Rotor Variator Drive | 1 | 244420A1 | A-244420A1 |
| 12 | Reel Drive Pump (47) | 1 | 1321564C2 | A-1321564C2 |
| 12 | Reel Drive Pump (54.5) | 1 | 1321565C2 | A-1321565C2 |
| 12 | Reel Drive Pump (47) | 1 | 1979606C1 | A-1979606C1 |
| 13 | Auxiliary Pump Drive | 1 | 1347387C1 | A-1347387C1 |
| 13 | Auxiliary Pump Drive | 1 | 1970115C1 | A-1970115C1 |
| 14 | Fan Jackshaft Drive | 1 | 191305C1 | A-191305C1 |
| 15 | Feeder Jackshaft Drive | 1 | 1313095C2 | A-1313095C2 |
| 15 | Feeder Jackshaft Drive | 1 | 1313097C3 | A-1313097C3 |
| 16 | Cleaning Unit Drive With Straw Chopper | 1 | 181055C1 | A-181055C1 |
| 19 | Fan Jackshaft Drive | 1 | 181359C1 | A-181359C1 |
| 20 | Fan Jackshaft Slow Speed | 1 | 610521R1 | A-610521R1 |

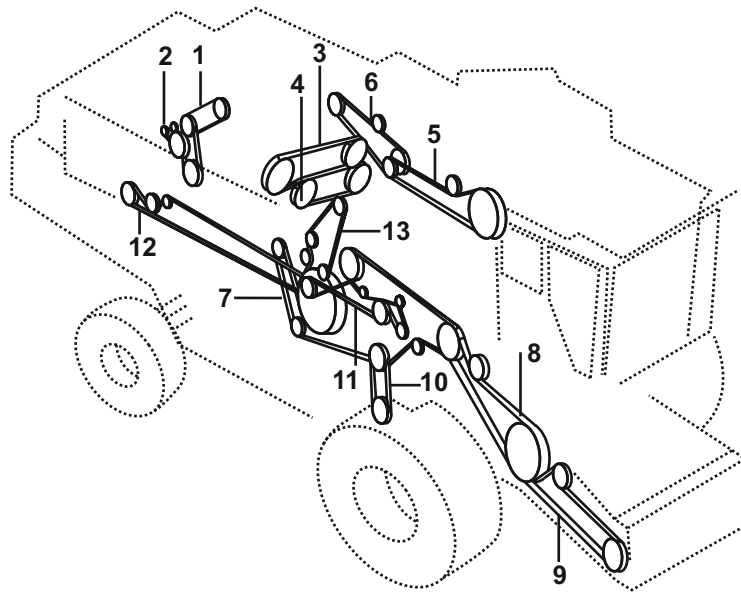

CASE INTL. HARVESTER 1644



| Belt No. |  | No. of Belts | OEM  Part No. | PIX  Part No. |
|----------|---|--------------|--|--|
| 1 | Compressor, A/c | 1 | 1250587C1 | A-1250587C1 |
| 2 | Fan, Alternator, Water Pump | 1 | J911565 | A-J911565 |
| 3 | Separator Drive | 1 | 191241C1 | A-191241C1 |
| 4 | Rotor Variable Drive | 1 | 193923C3 | A-193923C3 |
| 5 | Grain Tank Unloader Drive | 1 | 1989216C1 | A-1989216C1 |
| 6 | Auxilliary Pump Drive | 1 | 1347387C1 | A-1347387C1 |
| 7 | Straw Chopper Drive | 1 | 1315265C1 | A-1315265C1 |
| 8 | Feeder Drive W/rock Trap | 1 | 1315168C1 | A-1315168C1 |
| 9 | Feeder Jackshaft Drive,w/47" Feeder | 1 | 1313095C2 | A-1313095C2 |
| 9 | Feeder Jackshaft Drive W/54 1/2" Feeder | 1 | 1313097C3 | A-1313097C3 |
| 10 | Cleaning Fanjackshaft Drive | 1 | 191305C1 | A-191305C1 |
| 11 | Cleaning Fandrive | 1 | 1541569C1 | A-1541569C1 |
| 12 | Straw Spreaderdrive | 1 | 196371C1 | A-196371C1 |
| 13 | Elevator Drive | 1 | 181055C1 | A-181055C1 |
| 13 | Elevator Drive W/discharge Beater | 1 | 186509C2 | A-186509C2 |

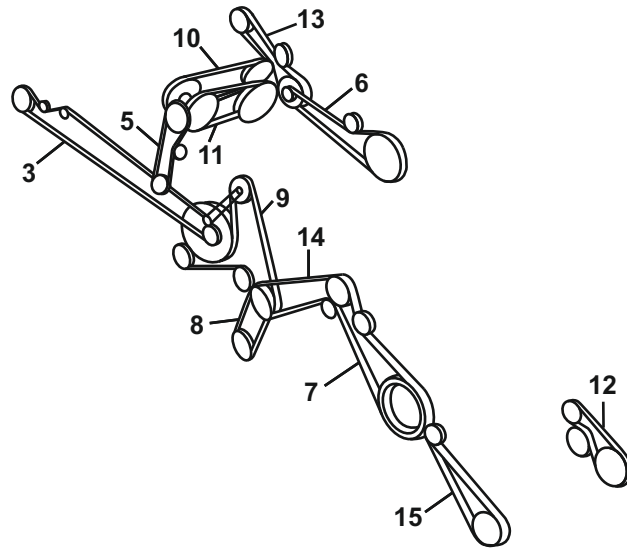

CASE INTL. HARVESTER 1660 (ENGINE DT466B)





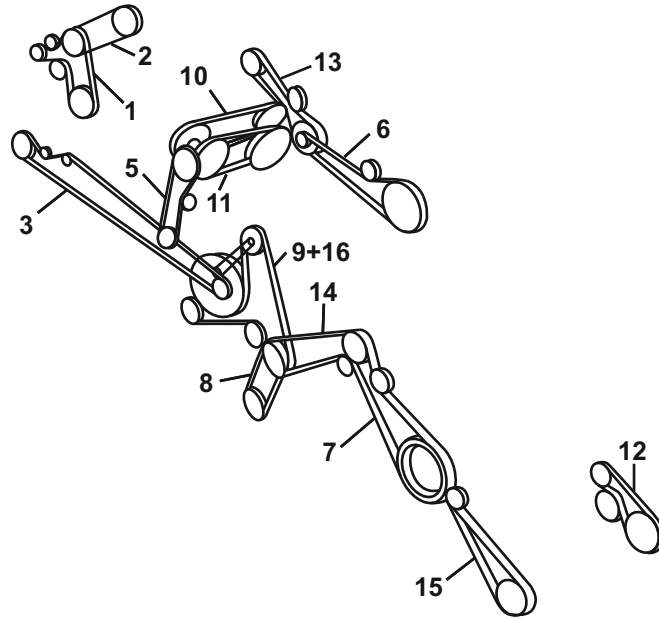

| Belt No. |  | No. of Belts | OEM  Part No. | PIX  Part No. |
|----------|---|--------------|--|--|
| 1 | Alternator, Fan and Waterpump Drive | 2 | 537072R92 | A-537072R92 |
| 2 | Air Conditioning Compressor Drive | 1 | 164550R2 | A-164550R2 |
| 3 | Straw Spreader Drive | 1 | 196371C1 | A-196371C1 |
| 5 | Straw Chopper Drive | 1 | 1315265C1 | A-1315265C1 |
| 6 | Unloading Auger Drive | 1 | 191290C1 | A-191290C1 |
| 7 | Feeder Drive Without Rock Trap | 1 | 192738C1 | A-192738C1 |
| 7 | Feeder Drive With Rock Trap | 1 | 1315168C1 | A-1315168C1 |
| 8 | Cleaning Fan Drive | 1 | 195396C2 | A-195396C2 |
| 9 | Elevator Drive Unit | 1 | 181055C1 | A-181055C1 |
| 10 | Separator Drive | 1 | 191241C3 | A-191241C3 |
| 11 | Rotor Variator Drive | 1 | 244420A1 | A-244420A1 |
| 12 | Reel Drive Pump | 1 | 1321564C2 | A-1321564C2 |
| 12 | Reel Drive Pump | 1 | 1321565C1 | A-1321565C1 |
| 13 | Auxiliary Pump Drive | 1 | 191288C3 | A-191288C3 |
| 14 | Fan Jackshaft Drive | 1 | 191305C1 | A-191305C1 |
| 15 | Feeder Jackshaft Drive | 1 | 1313095C2 | A-1313095C2 |
| 15 | Feeder Jackshaft Drive | 1 | 1313097C3 | A-1313097C3 |
| 19 | Fan Jackshaft Drive | 1 | 181359C1 | A-181359C1 |
| 20 | Fan Jackshaft Slow Speed | 1 | 610521R1 | A-610521R1 |

CASE INTL. HARVESTER 1660 (ENGINE NCE)

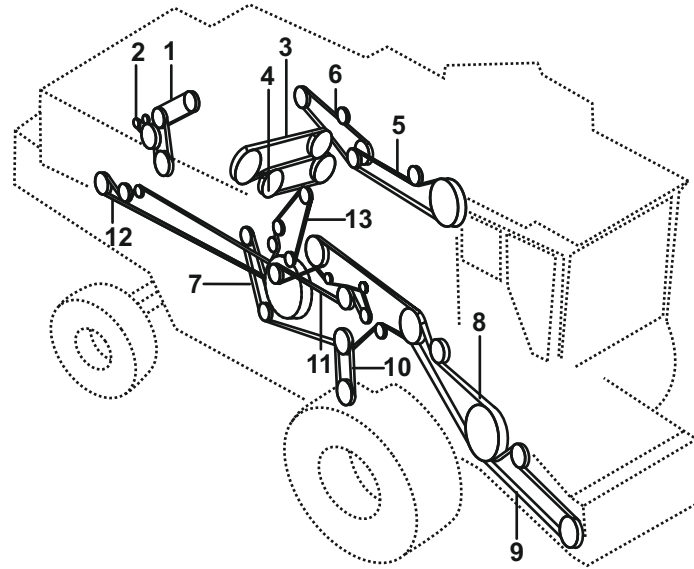





| Belt No. |  | No. of Belts | OEM  Part No. | PIX  Part No. |
|----------|---|--------------|--|--|
| 1 | Alternator, Fan and Waterpump Drive | 1 | J911572 | A-J911572 |
| 1 | Alternator, Fan and Waterpump Drive | 1 | J911574 | A-J911574 |
| 2 | Air Conditioning Compressor Drive | 1 | 396829R1 | A-396829R1 |
| 3 | Straw Spreader Drive | 1 | 196371C1 | A-196371C1 |
| 5 | Straw Chopper Drive | 1 | 1347157C1 | A-1347157C1 |
| 5 | Straw Chopper Drive | 1 | 1315265C1 | A-1315265C1 |
| 6 | Unloading Auger Drive | 1 | 191290C1 | A-191290C1 |
| 6 | Unloading Auger Drive | 1 | 1989216C1 | A-1989216C1 |
| 7 | Feeder Drive Without Rocktrap | 1 | 192738C1 | A-192738C1 |
| 7 | Feeder Drive With Rock Trap | 1 | 1315168C1 | A-1315168C1 |
| 8 | Cleaning Fandrive | 1 | 1541569C1 | A-1541569C1 |
| 8 | Cleaning Fandrive | 1 | 195396C2 | A-195396C2 |
| 9 | Elevator Drive Unit | 1 | 186509C2 | A-186509C2 |
| 10 | Separator Drive | 1 | 191241C3 | A-191241C3 |
| 11 | Rotor Variator Drive | 1 | 244420A1 | A-244420A1 |
| 12 | Reel Drive Pump (47) | 1 | 1321564C2 | A-1321564C2 |
| 12 | Reel Drive Pump (54.5) | 1 | 1321565C2 | A-1321565C2 |
| 12 | Reel Drive Pump (47) | 1 | 1979606C1 | A-1979606C1 |
| 13 | Auxiliary Pump Drive | 1 | 1347387C1 | A-1347387C1 |
| 13 | Auxiliary Pump Drive | 1 | 1541699C1 | A-1541699C1 |
| 13 | Auxiliary Pump Drive | 1 | 1970115C1 | A-1970115C1 |
| 14 | Fan Jackshaft Drive | 1 | 191305C1 | A-191305C1 |
| 15 | Feeder Jackshaft Drive | 1 | 1313095C2 | A-1313095C2 |
| 15 | Feeder Jackshaft Drive | 1 | 1313097C3 | A-1313097C3 |
| 16 | Cleaning Unit Drive With Straw Chopper | 1 | 181055C1 | A-181055C1 |
| 19 | Fan Jackshaft Drive | 1 | 181359C1 | A-181359C1 |
| 20 | Fan Jackshaft Slow Speed | 1 | 610521R1 | A-610521R1 |
| 21 | Chaff Spreader Drive (upper) | 1 | 123305A1 | A-123305A1 |

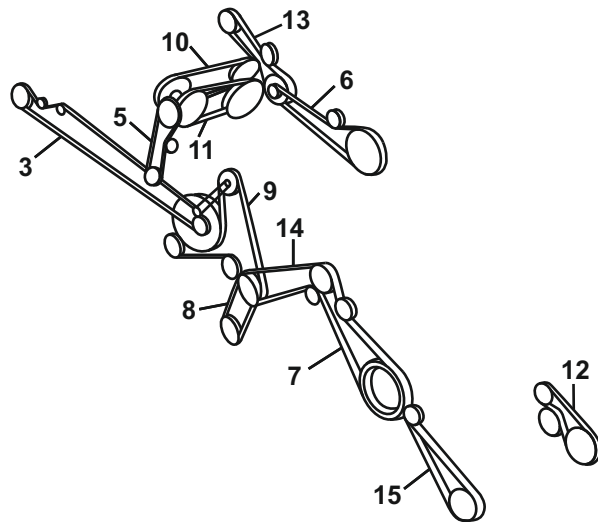

| Belt No. |  | No. of Belts | OEM  Part No. | PIX  Part No. |
|----------|---|--------------|--|--|
| 1 | Compressor, A/c | 1 | 396829R1 | A-396829R1 |
| 2 | Fan, Alternator, water Pump | 1 | J911572 | A-J911572 |
| 3 | Separator Drive | 1 | 191241C1 | A-191241C1 |
| 4 | Rotor Variable Drive | 1 | 193923C3 | A-193923C3 |
| 5 | Grain Tank Unloader Drive | 1 | 1989216C1 | A-1989216C1 |
| 6 | Auxilliary Pump Drive | 1 | 1347387C1 | A-1347387C1 |
| 7 | Straw Chopper Drive | 1 | 1315265C1 | A-1315265C1 |
| 8 | Feeder Drive W/rock Trap | 1 | 1315168C1 | A-1315168C1 |
| 9 | Feeder Jackshaft Drive, W/47" Feeder | 1 | 1313095C2 | A-1313095C2 |
| 9 | Feeder Jackshaft Drive W/54 1/2" Feeder | 1 | 1313097C3 | A-1313097C3 |
| 10 | Cleaning Fan Jackshaft Drive | 1 | 191305C1 | A-191305C1 |
| 11 | Cleaning Fan Drive | 1 | 1541569C1 | A-1541569C1 |
| 12 | Straw Spreader Drive | 1 | 196371C1 | A-196371C1 |
| 13 | Elevator Drive | 1 | 181055C1 | A-181055C1 |
| 13 | Elevator Drive W/discharge Beater | 1 | 186509C2 | A-186509C2 |

CASE INTL. HARVESTER 1680 (ENGINE DTI466C)



| Belt No. |  | No. of Belts | OEM  Part No. | PIX  Part No. |
|----------|---|--------------|--|--|
| 1 | Alternator, Fan and Waterpump Drive | 1 | 131201C92 | A-131201C92 |
| 2 | Air Conditioning Compressor Drive | 1 | 1250587C1 | A-1250587C1 |
| 3 | Straw Spreader Drive | 1 | 196371C1 | A-196371C1 |
| 5 | Straw Chopper Drive | 1 | 1315266C1 | A-1315266C1 |
| 6 | Unloading Auger Drive | 1 | 191291C1 | A-191291C1 |
| 7 | Feeder Drive With Rock Trap | 1 | 1315074C1 | A-1315074C1 |
| 7 | Feeder Drive Without Rocktrap | 1 | 194528C1 | A-194528C1 |
| 8 | Cleaning Fandrive | 1 | 195396C2 | A-195396C2 |
| 9 | Elevator Drive Unit | 1 | 186509C2 | A-186509C2 |
| 10 | Separator Drive | 1 | 191244C1 | A-191244C1 |
| 11 | Rotor Variatordrive | 1 | 244422A1 | A-244422A1 |
| 12 | Reel Drive Pump | 1 | 1315226C1 | A-1315226C1 |
| 12 | Reel Drive Pump | 1 | 1321565C1 | A-1321565C1 |
| 13 | Auxiliary Pump Drive | 1 | 191288C3 | A-191288C3 |
| 14 | Fan Jackshaft Drive | 1 | 188213C1 | A-188213C1 |
| 15 | Feeder Jackshaft Drive | 1 | 1313097C3 | A-1313097C3 |
| 15 | Feeder Jackshaft Drive | 1 | 1308489C2 | A-1308489C2 |
| 16 | Cleaning Unit Drive With Straw Chopper | 1 | 181055C1 | A-181055C1 |
| 19 | Fan Jackshaft Drive | 1 | 181359C1 | A-181359C1 |
| 20 | Fan Jackshaft Slow Speed | 1 | 610521R1 | A-610521R1 |

CASE INTL. HARVESTER 1680 (ENGINE NCE)

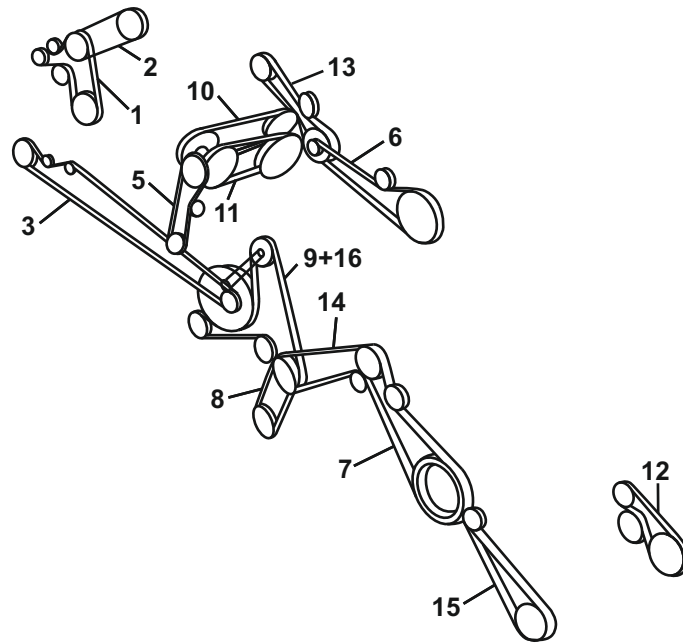

| Belt No. |  | No. of Belts | OEM  Part No. | PIX  Part No. |
|----------|---|--------------|--|--|
| 1 | Alternator, Fan and Waterpump Drive | 1 | J911572 | A-J911572 |
| 1 | Alternator, Fan and Waterpump Drive | 1 | J911574 | A-J911574 |
| 2 | Air Conditioning Compressor Drive | 1 | 396829R1 | A-396829R1 |
| 3 | Straw Spreader Drive | 1 | 196371C1 | A-196371C1 |
| 5 | Straw Chopper Drive | 1 | 1347160C1 | A-1347160C1 |
| 5 | Straw Chopper Drive | 1 | 1315266C1 | A-1315266C1 |
| 6 | Unloading Auger Drive | 1 | 191291C1 | A-191291C1 |
| 6 | Unloading Auger Drive | 1 | 1989217C1 | A-1989217C1 |
| 7 | Feeder Drive | 1 | 194528C1 | A-194528C1 |
| 8 | Cleaning Fan Drive | 1 | 1541569C1 | A-1541569C1 |
| 8 | Cleaning Fan Drive | 1 | 195396C2 | A-195396C2 |
| 9 | Elevator Drive Unit | 1 | 186509C2 | A-186509C2 |
| 10 | Separator Drive | 1 | 1330499C1 | A-1330499C1 |
| 10 | Separator Drive | 1 | 1541702C1 | A-1541702C1 |
| 11 | Rotor Variator Drive | 1 | 244422A1 | A-244422A1 |
| 12 | Reel Drive Pump (60) | 1 | 1315226C1 | A-1315226C1 |
| 12 | Reel Drive Pump (54.5) | 1 | 1321565C1 | A-1321565C1 |
| 12 | Reel Drive Pump (60) | 1 | 1979607C1 | A-1979607C1 |
| 13 | Auxiliary Pump Drive | 1 | 1347358C1 | A-1347358C1 |
| 13 | Auxiliary Pump Drive | 1 | 1541700C1 | A-1541700C1 |
| 13 | Auxiliary Pump Drive | 1 | 1970116C1 | A-1970116C1 |
| 14 | Fan Jackshaft Drive | 1 | 188213C1 | A-188213C1 |
| 15 | Feeder Jackshaft Drive | 1 | 1313097C3 | A-1313097C3 |
| 15 | Feeder Jackshaft Drive | 1 | 1308489C2 | A-1308489C2 |
| 16 | Cleaning Unit Drive With Straw Chopper | 1 | 181055C1 | A-181055C1 |
| 19 | Fan Jackshaft Drive | 1 | 181359C1 | A-181359C1 |
| 20 | Fan Jackshaft Slow Speed | 1 | 610521R1 | A-610521R1 |
| 21 | Chaff Spreader Drive (upper) | 1 | 123305A1 | A-123305A1 |
| 22 | Chaff Spreader Drive (lower) | 1 | 123307A1 | A-123307A1 |

CASE INTL. HARVESTER 1688

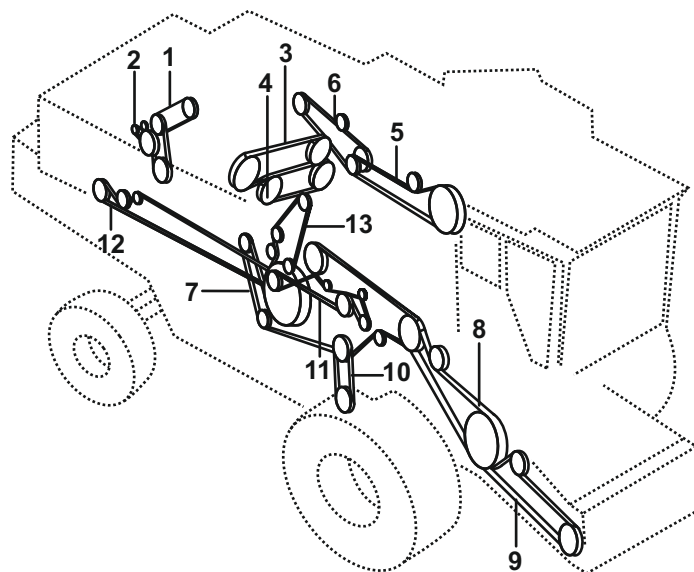



| Belt No. | | No. of Belts | OEM Part No. | PIX Part No. |
|----------|---|--------------|---------------|---------------|
| 1 | Compressor, A/c | 1 | 396829R1 | A-396829R1 |
| 2 | Fan, Alternator, Water Pump | 1 | J911572 | A-J911572 |
| 3 | Separator Drive | 1 | 1541702C1 | A-1541702C1 |
| 4 | Rotor Drive | 1 | 193945C2 | A-193945C2 |
| 5 | Grain Tank Unloader Drive | 1 | 1989217C1 | A-1989217C1 |
| 6 | Auxilliary Pump Drive | 1 | 1541700C1 | A-1541700C1 |
| 7 | Straw Chopper Drive | 1 | 1315266C1 | A-1315266C1 |
| 8 | Feeder Drive W/rock Trap | 1 | 1315074C1 | A-1315074C1 |
| 8 | Feeder Drive W/o Rocktrap | 1 | 194528C1 | A-194528C1 |
| 9 | Feeder Jackshaft Drive W/60" Feeder | 1 | 1308489C2 | A-1308489C2 |
| 9 | Feeder Jackshaft Drive W/54 1/2" Feeder | 1 | 1313097C3 | A-1313097C3 |
| 10 | Cleaning Fanjackshaft Drive | 1 | 188213C1 | A-188213C1 |
| 11 | Cleaning Fandrive | 1 | 1541569C1 | A-1541569C1 |
| 12 | Straw Spreaderdrive | 1 | 196371C1 | A-196371C1 |
| 13 | Elevator Drive | 1 | 181055C1 | A-181055C1 |
| 13 | Elevator Drive W/dischargebeater | 1 | 186509C2 | A-186509C2 |

CASE INTL. HARVESTER 2055

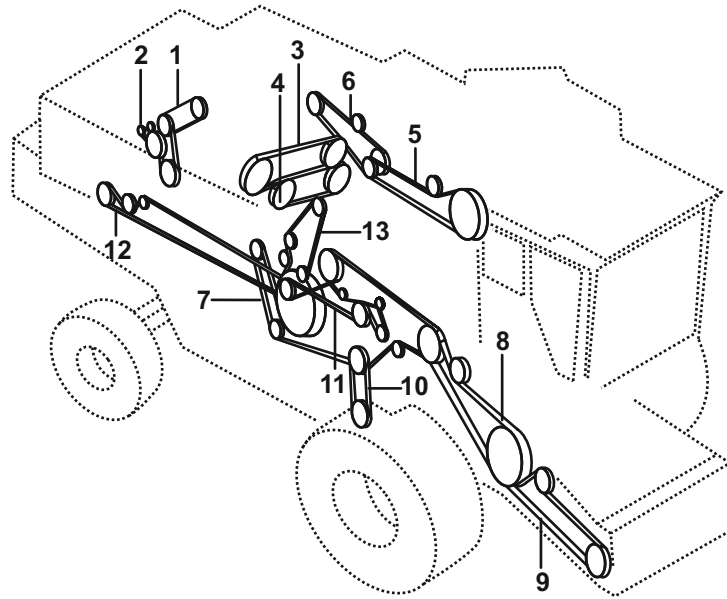

| Belt No. | | No. of Belts | OEM Part No. | PIX Part No. |
|----------|----------------------|--------------|---------------|---------------|
| 1 | FAN (FRONT) | 1 | 1338328C1 | A-1338328C1 |
| 2 | FAN DRIVE | 1 | 1546117C2 | A-1546117C2 |
| 3 | HYDRAULIC PUMP DRIVE | 1 | 1546118C1 | A-1546118C1 |





| Belt No. |  | No. of Belts | OEM  Part No. | PIX  Part No. |
|----------|---|--------------|--|--|
| 1 | Compressor, A/c | 1 | 1250587C1 | A-1250587C1 |
| 2 | Fan, Alternator, water Pump | 1 | J911565 | A-J911565 |
| 3 | Separator Drive | 1 | 191241C1 | A-191241C1 |
| 4 | Rotor Variable Drive | 1 | 193923C3 | A-193923C3 |
| 5 | Grain Tank Unloader Drive | 1 | 1989216C1 | A-1989216C1 |
| 6 | Auxilliary Pump Drive | 1 | 124573A1 | A-124573A1 |
| 7 | Straw Chopper Drive | 1 | 1315265C1 | A-1315265C1 |
| 8 | Feeder Drive W/rock Trap | 1 | 1315168C1 | A-1315168C1 |
| 9 | Feeder Jackshaft Drive W/60" Feeder | 1 | 1308489C2 | A-1308489C2 |
| 9 | Feeder Jackshaft Drive W/54 1/2" Feeder | 1 | 1313097C3 | A-1313097C3 |
| 11 | Cleaning Fan Drive | 1 | 1541569C1 | A-1541569C1 |
| 12 | Straw Spreader Drive | 1 | 196371C1 | A-196371C1 |
| 13 | Elevator Drive W/discharge Beater | 1 | 186509C2 | A-186509C2 |

CASE INTL. HARVESTER



CASE INTL. HARVESTER 2166

| Belt No. |  | No. of Belts | OEM  Part No. | PIX  Part No. |
|----------|---|--------------|--|--|
| 1 | Alternator, Fan And Water pump Drive | 1 | J911572 | A-J911572 |
| 2 | Air Conditioning Compressor Drive | 1 | 396829R1 | A-396829R1 |
| 3 | Straw Spreader Drive | 1 | 196371C1 | A-196371C1 |
| 5 | Straw Chopper Drive | 1 | 1347157C1 | A-1347157C1 |
| 6 | Unloading Auger Drive | 1 | 191290C1 | A-191290C1 |
| 7 | Feeder Drive Without Rock trap | 1 | 192738C1 | A-192738C1 |
| 7 | Feeder Drive With Rock Trap | 1 | 1315168C1 | A-1315168C1 |
| 8 | Cleaning Fan drive | 1 | 1541569C1 | A-1541569C1 |
| 9 | Elevator Drive Unit | 1 | 186509C2 | A-186509C2 |
| 10 | Separator Drive | 1 | 191241C3 | A-191241C3 |
| 11 | Rotor Variator drive | 1 | 244420A1 | A-244420A1 |
| 13 | Auxiliary Pump Drive | 1 | 124572A1 | A-124572A1 |
| 14 | Fan Jackshaft Drive | 1 | 191305C1 | A-191305C1 |
| 15 | Feeder Jackshaft Drive | 1 | 1313097C3 | A-1313097C3 |
| 15 | Feeder Jackshaft Drive | 1 | 1308489C2 | A-1308489C2 |
| 16 | Cleaning Unit Drive | 1 | 181055C1 | A-181055C1 |
| 21 | Chaff Spreader drive (upper) | 1 | 123305A1 | A-123305A1 |
| 22 | Chaff Spreader drive (lower) | 1 | 123306A1 | A-123306A1 |

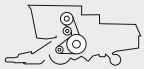

CASE INTL. HARVESTER 2188

| Belt No. |  | No. of Belts | OEM  Part No. | PIX  Part No. |
|----------|---|--------------|--|--|
| 1 | ALTERNATOR, FAN AND WATERPUMP DRIVE | 1 | J911572 | A-J911572 |
| 2 | AIR CONDITIONING COMPRESSOR DRIVE | 1 | 396829R1 | A-396829R1 |
| 3 | STRAW SPREADER DRIVE | 1 | 196371C1 | A-196371C1 |
| 5 | STRAW CHOPPER DRIVE | 1 | 1347160C1 | A-1347160C1 |
| 7 | FEEDER DRIVE WITH ROCK TRAP | 1 | 1315074C1 | A-1315074C1 |
| 7 | FEEDER DRIVE WITHOUT ROCKTRAP | 1 | 194528C1 | A-194528C1 |
| 8 | CLEANING FANDRIVE | 1 | 1541569C1 | A-1541569C1 |
| 9 | ELEVATOR DRIVE UNIT | 1 | 186509C2 | A-186509C2 |
| 10 | SEPARATOR DRIVE | 1 | 1541702C1 | A-1541702C1 |
| 11 | ROTOR VARIATOR DRIVE | 1 | 244422A1 | A-244422A1 |
| 13 | AUXILIARY PUMP DRIVE | 1 | 124573A1 | A-124573A1 |
| 14 | FAN JACKSHAFT DRIVE | 1 | 188213C1 | A-188213C1 |
| 15 | FEEDER JACKSHAFT DRIVE | 1 | 1313097C3 | A-1313097C3 |
| 15 | FEEDER JACKSHAFT DRIVE | 1 | 1308489C2 | A-1308489C2 |
| 16 | CLEANING UNIT DRIVE | 1 | 181055C1 | A-181055C1 |
| 21 | CHAFF SPREADERDRIVE (UPPER) | 1 | 123305A1 | A-123305A1 |
| 22 | CHAFF SPREADERDRIVE (LOWER) | 1 | 123307A1 | A-123307A1 |

CASE INTL. HARVESTER 2365 - 2366

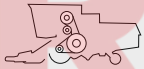

| Belt No. |  | No. of Belts | OEM  Part No. | PIX  Part No. |
|----------|---|--------------|--|--|
| 1 | ALTERNATOR, FANAND WATERPUMP DRIVE | 1 | J911572 | A-J911572 |
| 2 | AIR CONDITIONING COMPRESSOR DRIVE | 1 | 396829R1 | A-396829R1 |
| 3 | STRAW SPREADER DRIVE | 1 | 196371C1 | A-196371C1 |
| 5 | STRAW CHOPPER DRIVE | 1 | 1347157C1 | A-1347157C1 |
| 6 | UNLOADING AUGER DRIVE | 1 | 191290C1 | A-191290C1 |
| 7 | FEEDER DRIVE WITHOUT ROCK TRAP | 1 | 192738C1 | A-192738C1 |
| 8 | CLEANING FAN DRIVE | 1 | 301146A1 | A-301146A1 |
| 9 | ELEVATOR DRIVE UNIT | 1 | 186509C2 | A-186509C2 |
| 10 | SEPARATOR DRIVE | 1 | 191241C3 | A-191241C3 |
| 11 | ROTOR VARIATOR DRIVE | 1 | 244420A1 | A-244420A1 |
| 13 | AUXILIARY PUMP DRIVE | 1 | 124572A1 | A-124572A1 |
| 14 | FAN JACKSHAFT DRIVE | 1 | 301111A1 | A-301111A1 |
| 15 | FEEDER JACKSHAFT DRIVE | 1 | 1313097C3 | A-1313097C3 |
| 15 | FEEDER JACKSHAFT DRIVE | 1 | 1308489C2 | A-1308489C2 |
| 16 | CLEANING UNIT DRIVE | 1 | 181055C1 | A-181055C1 |

CASE INTL. HARVESTER 2388

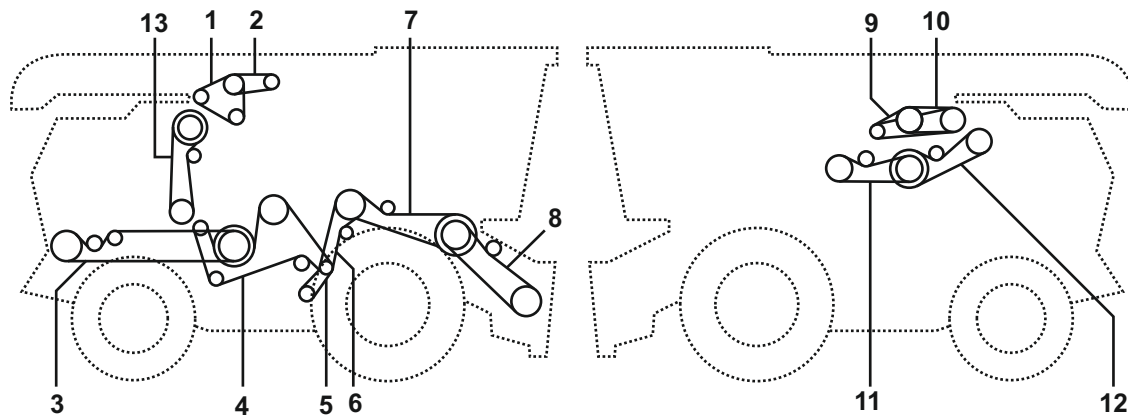

| Belt No. |  | No. of Belts | OEM  Part No. | PIX  Part No. |
|----------|---|--------------|--|--|
| 1 | ALTERNATOR, FANAND WATERPUMP DRIVE | 1 | J911572 | A-J911572 |
| 2 | AIR CONDITIONING COMPRESSOR DRIVE | 1 | 396829R1 | A-396829R1 |
| 3 | STRAW SPREADER DRIVE | 1 | 196371C1 | A-196371C1 |
| 5 | STRAW CHOPPER DRIVE | 1 | 1347157C1 | A-1347157C1 |
| 7 | FEEDER DRIVE WITHOUT ROCK TRAP | 1 | 192738C1 | A-192738C1 |
| 8 | CLEANING FAN DRIVE | 1 | 301146A1 | A-301146A1 |
| 9 | ELEVATOR DRIVE UNIT | 1 | 186509C2 | A-186509C2 |
| 10 | SEPARATOR DRIVE | 1 | 1541702C1 | A-1541702C1 |
| 11 | ROTOR VARIATOR DRIVE | 1 | 244423A1 | A-244423A1 |
| 13 | AUXILIARY PUMP DRIVE | 1 | 124573A1 | A-124573A1 |
| 14 | FAN JACKSHAFT DRIVE | 1 | 317904A1 | A-317904A1 |
| 15 | FEEDER JACKSHAFT DRIVE | 1 | 1308489C2 | A-1308489C2 |
| 15 | FEEDER JACKSHAFT DRIVE | 1 | 1313097C3 | A-1313097C3 |
| 16 | CLEANING UNIT DRIVE | 1 | 181055C1 | A-181055C1 |

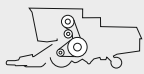
CASE INTL. HARVESTER 5088



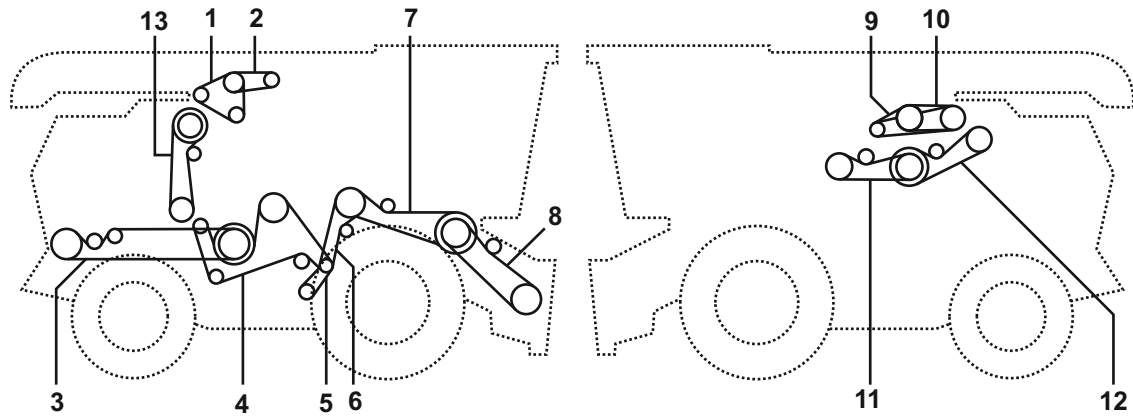



| Belt No. |  | No. of Belts | OEM  Part No. | PIX  Part No. |
|----------|---|--------------|--|--|
| 1 | Fan Drive | 1 | 87755884 | A-87755884 |
| 2 | A/c Compressor | 1 | 87311867 | A-87311867 |
| 3 | Straw Spreader Drive | 1 | 84163222 | A-84163222 |
| 4 | Cleaning System Drive (with Beater) | 1 | 87476487 | A-87476487 |
| 4 | Cleaning System Drive (with Chopper) | 1 | 87476486 | A-87476486 |
| 5 | Cleaning Fandrive | 1 | 301146A1 | A-301146A1 |
| 6 | Fan Jackshaft Drive | 1 | 87642957 | A-87642957 |
| 7 | Feeder Drive (with Rock Trap) | 1 | 87629601 | A-87629601 |
| 7 | Feeder Drive (w/o Rock Trap) | 1 | 87629602 | A-87629602 |
| 8 | Header Drive (with Rock Trap) | 1 | 87332159 | A-87332159 |
| 8 | Header Drive (w/o Rocktrap) | 1 | 87332161 | A-87332161 |
| 9 | Separator Drive | 1 | 84137716 | A-84137716 |
| 10 | Rotor Drive | 1 | 84194650 | A-84194650 |
| 11 | Unloader Drive | 1 | 87566055 | A-87566055 |
| 12 | Auxiliary Pump Dr (w/2.5 Bu/sec Unloader) | 1 | 87330894 | A-87330894 |
| 12 | Auxiliary Pump Dr (w/3.0 Bu/sec Unloader) | 1 | 87549556 | A-87549556 |
| 13 | Straw Chopper Drive | 1 | 87330903 | A-87330903 |



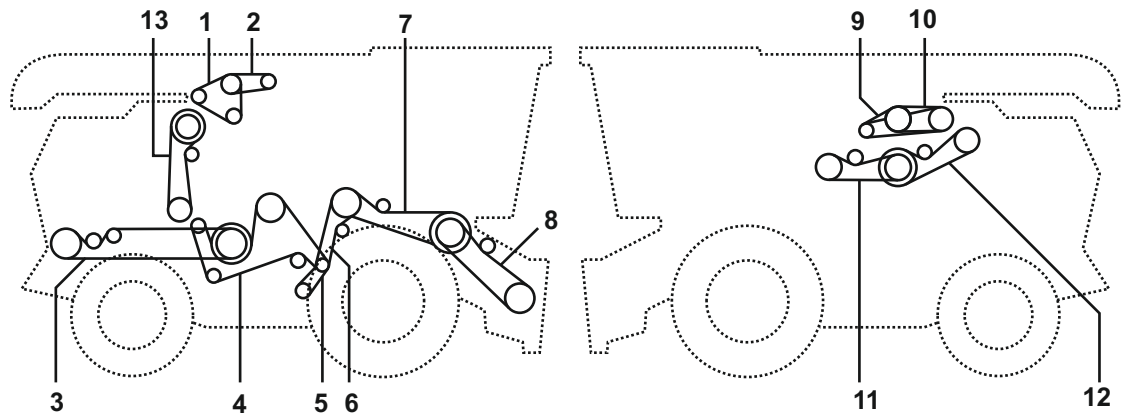



| Belt No. |  | No. of Belts | OEM  Part No. | PIX  Part No. |
|----------|---|--------------|--|--|
| 1 | Fan Drive | 1 | 87755884 | A-87755884 |
| 2 | A/c Compressor | 1 | 87311867 | A-87311867 |
| 3 | Straw Spreader Drive | 1 | 84163222 | A-84163222 |
| 4 | Cleaning System Drive (with Beater) | 1 | 87476487 | A-87476487 |
| 4 | Cleaning System Drive (with Chopper) | 1 | 87476486 | A-87476486 |
| 5 | Cleaning Fan Drive | 1 | 301146A1 | A-301146A1 |
| 6 | Fan Jackshaft Drive | 1 | 87642957 | A-87642957 |
| 7 | Feeder Drive (with Rock Trap) | 1 | 87629601 | A-87629601 |
| 7 | Feeder Drive (w/rock Trap) | 1 | 87629602 | A-87629602 |
| 8 | Header Drive (with Rock Trap) | 1 | 87332159 | A-87332159 |
| 8 | Header Drive (w/rock Trap) | 1 | 87332161 | A-87332161 |
| 9 | Separator Drive | 1 | 84137716 | A-84137716 |
| 10 | Rotor Drive | 1 | 87615553 | A-87615553 |
| 11 | Unloader Drive | 1 | 87549557 | A-87549557 |
| 12 | Auxiliary Pump Dr (w/2.5 Bu/sec Unloader) | 1 | 87330894 | A-87330894 |
| 12 | Auxiliary Pump Dr (w/3.0 Bu/sec Unloader) | 1 | 87549556 | A-87549556 |
| 13 | Straw Chopper Drive | 1 | 87330903 | A-87330903 |

CASE INTL. HARVESTER 7088

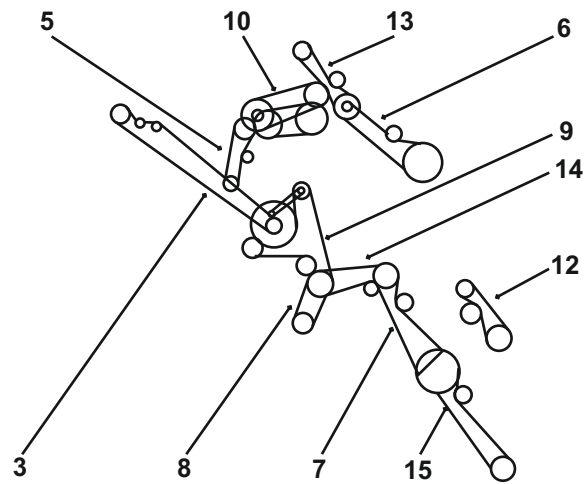



| Belt No. |  | No. of Belts | OEM  Part No. | PIX  Part No. |
|----------|---|--------------|--|--|
| 1 | Fan Drive | 1 | 87755884 | A-87755884 |
| 2 | A/c Compressor | 1 | 87311867 | A-87311867 |
| 3 | Straw Spreader Drive | 1 | 84163222 | A-84163222 |
| 4 | Cleaning System Drive (with Beater) | 1 | 87476487 | A-87476487 |
| 4 | Cleaning System Drive (with Chopper) | 1 | 87476486 | A-87476486 |
| 5 | Cleaning Fandrive | 1 | 301146A1 | A-301146A1 |
| 6 | Fan Jackshaft Drive | 1 | 87642957 | A-87642957 |
| 7 | Feeder Drive (with Rock Trap) | 1 | 87629601 | A-87629601 |
| 7 | Feeder Drive (w/o Rock Trap) | 1 | 87629602 | A-87629602 |
| 8 | Header Drive (with Rock Trap) | 1 | 87332159 | A-87332159 |
| 8 | Header Drive (w/o Rock Trap) | 1 | 87332161 | A-87332161 |
| 9 | Separator Drive | 1 | 84137716 | A-84137716 |
| 10 | Rotor Drive | 1 | 87615553 | A-87615553 |
| 11 | Unloader Drive | 1 | 87549557 | A-87549557 |
| 12 | Auxiliary Pump Dr (w/2.5 Bu/sec Unloader) | 1 | 87330894 | A-87330894 |
| 12 | Auxiliary Pump Dr (w/3.0 Bu/sec Unloader) | 1 | 87549556 | A-87549556 |
| 13 | Straw Chopper Drive | 1 | 87330903 | A-87330903 |





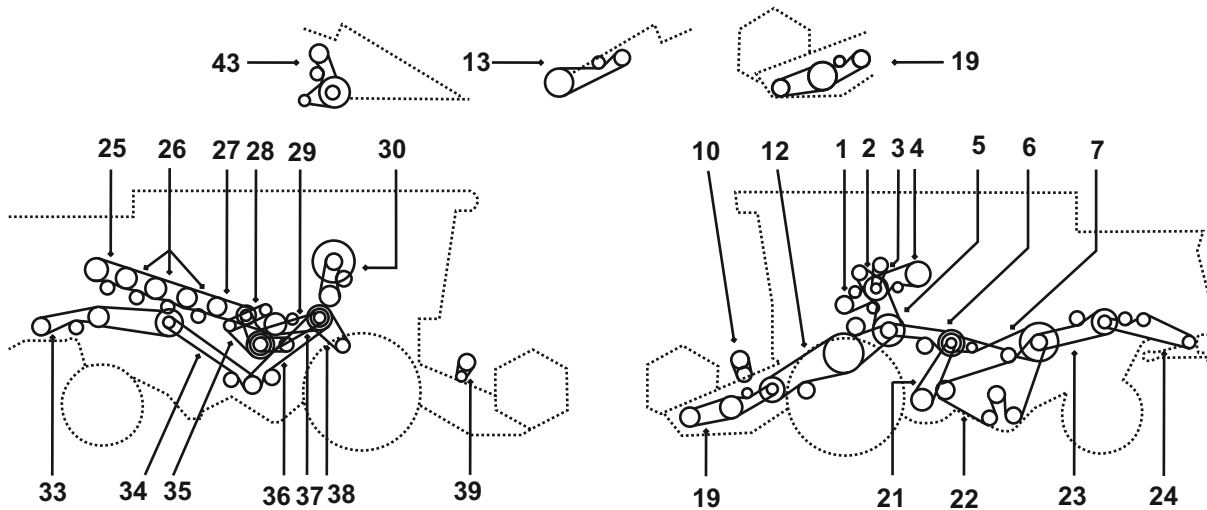

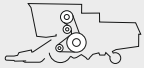
| Belt No. |  | No. of Belts | OEM  Part No. | PIX  Part No. |
|----------|---|--------------|--|--|
| 1 | Baler | 1 | 506880.0 | A-506880.0 |
| 1 | Baler | 1 | 506940.0 | A-506940.0 |
| 2 | Alternator Drive | 1 | 624131.0 | A-624131.0 |
| 2 | Alternator Drive | 1 | 750624.0 | A-750624.0 |
| 2 | Alternator Drive | 1 | 750296.0 | A-750296.0 |
| 3 | Knife Drive | 1 | 801221.0 | A-801221.0 |
| 3 | Knife Drive | 1 | 756051.0 | A-756051.0 |
| 4 | Tank Unloader Drive | 1 | 756059.0 | A-756059.0 |
| 5 | Cutting Table Drive | 1 | 772657.0 | A-772657.0 |
| 6 | Spreader Grain In Tank | 1 | 775698.0 | A-775698.0 |
| 7 | Pick Up Drive | 1 | 800309.0 | A-800309.0 |
| 8 | Shaker Shoe Fanning Mill | 1 | 506023.0 | A-506023.0 |
| 9 | Threshing Machine | 1 | 801222.0 | A-801222.0 |
| 10 | Traction Drive | 1 | 750294.0 | A-750294.0 |
| 11 | Traction Drive | 1 | 751112.0 | A-751112.0 |
| 12 | Shaker Shoe Fanning Mill | 1 | 772658.0 | A-772658.0 |
| 12 | Shaker Shoe Fanning Mill | 1 | 772660.0 | A-772660.0 |
| 13 | Straw Walker Elevator | 1 | 774100.0 | A-774100.0 |
| 13 | Straw Walker Elevator | 1 | 773313.0 | A-773313.0 |

CLAAS COMMANDOR 114

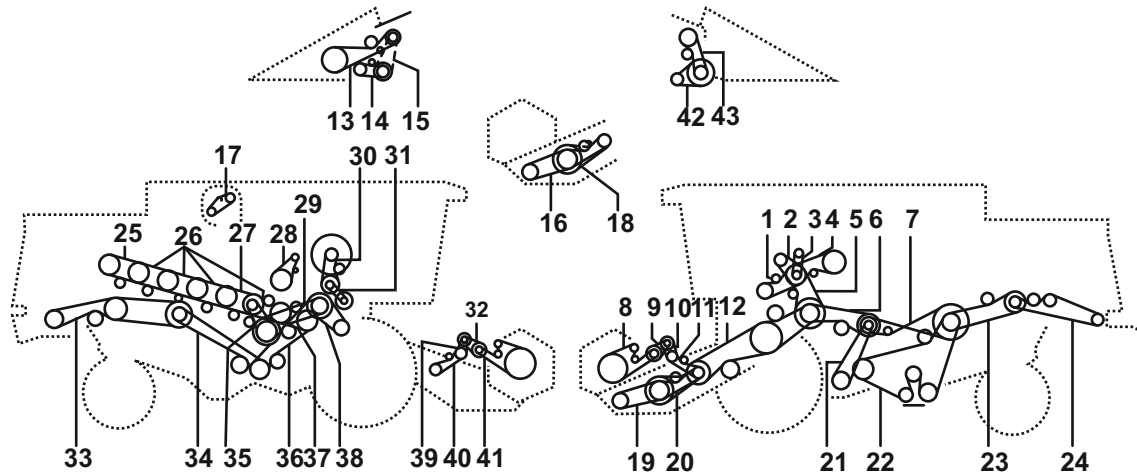





| Belt No. |  | No. of Belts | OEM  Part No. | PIX  Part No. |
|----------|---|--------------|--|--|
| 1 | - | 1 | 629279.0 | A-629279.0 |
| 2 | - | 1 | 629002.1 | A-629002.1 |
| 3 | - | 1 | 629908.1 | A-629908.1 |
| 4 | - | 1 | 629763.0 | A-629763.0 |
| 5 | - | 1 | 629000.1 | A-629000.1 |
| 6 | - | 1 | 603337.0 | A-603337.0 |
| 7 | - | 1 | 644141.0 | A-644141.0 |
| 10 | To 5.1 M Cutting Table | 1 | 670224.1 | A-670224.1 |
| 12 | - | 2 | 603017.3 | A-603017.3 |
| 13 | For Maize Picker | 1 | 692149.0 | A-692149.0 |
| 13 | For Maize Picker | 1 | 692150.0 | A-692150.0 |
| 16 | From 6.0 M Cutting Table | 1 | 671013.1 | A-671013.1 |
| 19 | To 5.1 M Cutting Table | 1 | 713506.2 | A-713506.2 |
| 21 | - | 1 | 603380.0 | A-603380.0 |
| 22 | - | 1 | 609762.0 | A-609762.0 |
| 23 | For Straw Distributor | 1 | 506671.1 | A-506671.1 |
| 24 | For Straw Distributor | 1 | 640653.1 | A-640653.1 |
| 25 | - | 1 | 644014.1 | A-644014.1 |
| 26 | - | 1 | 644015.1 | A-644015.1 |
| 27 | - | 1 | 644016.1 | A-644016.1 |
| 29 | - | 1 | 064168.2 | A-064168.2 |
| 30 | - | 1 | 233843.1 | A-233843.1 |
| 33 | For Maize | 2 | 061872.0 | A-061872.0 |
| 33 | For Grain | 1 | 061701.1 | A-061701.1 |
| 34 | For Straw Chopper | 1 | 061700.0 | A-061700.0 |
| 35 | - | 1 | 603247.1 | A-603247.1 |
| 37 | - | 1 | 644014.1 | A-644014.1 |
| 38 | Cylinder N=650-1500 Rpm | 1 | 628630.0 | A-628630.0 |
| 38 | Cylinder N=500-1400 Rpm | 1 | 644177.0 | A-644177.0 |
| 39 | From 6.0 M Cutting Table | 1 | 670224.1 | A-670224.1 |
| 43 | - | 1 | 680334.1 | A-680334.1 |

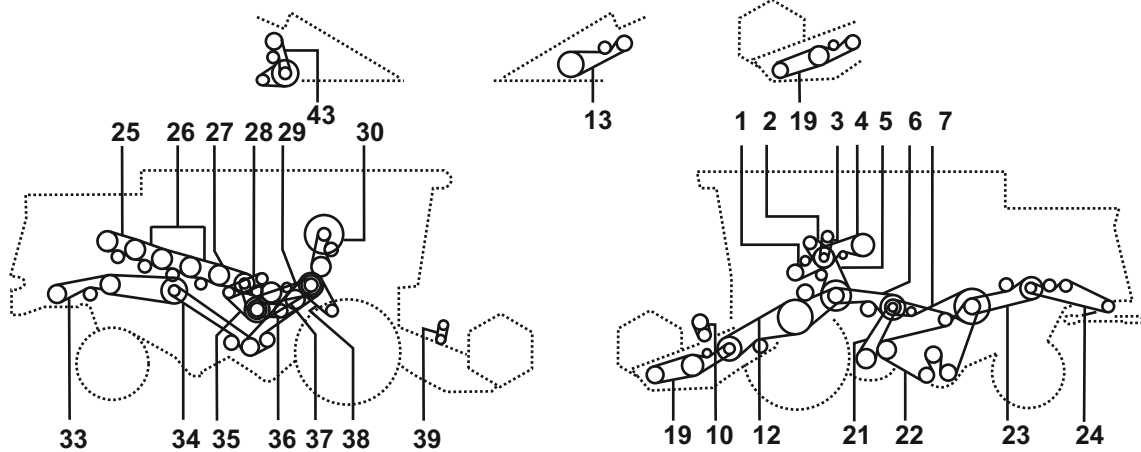

| Belt No. |  | No. of Belts | OEM  Part No. | PIX  Part No. |
|----------|---|--------------|--|--|
| 1 | Ground Drive | 1 | 629279.0 | A-629279.0 |
| 2 | Hydraulic Pump | 1 | 629002.1 | A-629002.1 |
| 3 | Air Conditioner | 1 | 629908.1 | A-629908.1 |
| 4 | Grain Tank Unloading | 1 | 629763.0 | A-629763.0 |
| 5 | Intermediate Drive Threshing Mechanism | 1 | 629000.1 | A-629000.1 |
| 6 | Intermediate Drive Blower | 1 | 603337.0 | A-603337.0 |
| 7 | Intermediate Drive Sieve Pan | 1 | 644141.1 | A-644141.1 |
| 10 | To 5.1 M Cutterbar | 1 | 670224.1 | A-670224.1 |
| 12 | Feeder Housing Cutterbar | 2 | 603017.3 | A-603017.3 |
| 13 | For Corn Picker | 1 | 692149.0 | A-692149.0 |
| 13 | For Corn Picker | 1 | 692150.0 | A-692150.0 |
| 16 | From 6.0m Cutterbar | 1 | 671013.1 | A-671013.1 |
| 19 | To 5.1 M Cutterbar | 1 | 713506.2 | A-713506.2 |
| 21 | Blower - Variable Speed Drive | 1 | 603380.1 | A-603380.1 |
| 22 | Sieve Box | 1 | 609762.0 | A-609762.0 |
| 23 | Intermediate Drive Straw Distributor | 1 | 506671.2 | A-506671.2 |
| 24 | For Straw Spreader | 1 | 640653.1 | A-640653.1 |
| 25 | 8. Separator Drum | 1 | 644014.1 | A-644014.1 |
| 26 | 3.5, 6.7 Separator Drum | 4 | 644015.1 | A-644015.1 |
| 27 | 4th Separator Drum | 1 | 644016.1 | A-644016.1 |
| 29 | Intermediate Drive Drum Variable Speed | 1 | 064168.2 | A-064168.2 |
| 30 | Rotor Drive | 1 | 783430.1 | A-783430.1 |
| 30 | To No; 14900195 | 1 | 233843.1 | A-233843.1 |
| 33 | Chopper, Grain | 1 | 061701.2 | A-061701.2 |
| 33 | Chopper, Corn | 2 | 061872.0 | A-061872.0 |
| 34 | Intermediate Drive li Chopper | 1 | 061700.1 | A-061700.1 |
| 35 | Intermediate Drive Separator Drum | 1 | 603247.1 | A-603247.1 |
| 36 | Intermediate Drive l Chopper | 1 | 061700.1 | A-061700.1 |
| 37 | 1ste and 2nd Separator Drum | 1 | 644014.1 | A-644014.1 |
| 38 | At N = 650 - 1500 Min-1 | 1 | 628630.0 | A-628630.0 |
| 38 | At N = 500 - 1400 Min-1 Claas | 1 | 644177.0 | A-644177.0 |
| 39 | From 6.0 M Cutterbar | 1 | 670224.1 | A-670224.1 |
| 43 | For Hph - G Picker | 1 | 680334.1 | A-680334.1 |

CLAAS COMMANDOR 115



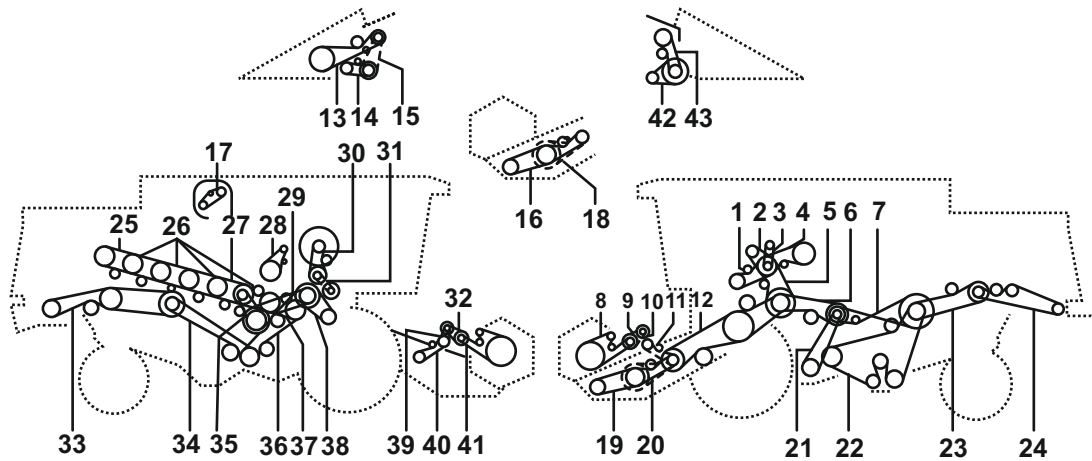

| Belt No. |  | No. of Belts | OEM  Part No. | PIX  Part No. |
|----------|---|--------------|--|--|
| 1 | - | 1 | 644017.0 | A-644017.0 |
| 2 | - | 1 | 629002.1 | A-629002.1 |
| 3 | - | 1 | 629908.1 | A-629908.1 |
| 4 | - | 1 | 629763.0 | A-629763.0 |
| 5 | - | 1 | 644018.1 | A-644018.1 |
| 6 | - | 1 | 603337.0 | A-603337.0 |
| 7 | - | 1 | 644141.0 | A-644141.0 |
| 10 | To 5.1 M Cutting Table | 1 | 670224.1 | A-670224.1 |
| 12 | - | 2 | 603017.3 | A-603017.3 |
| 13 | For Maize Picker | 1 | 692149.0 | A-692149.0 |
| 13 | For Maize Picker | 1 | 692150.0 | A-692150.0 |
| 16 | From 6.0m Cutting Table | 1 | 671013.1 | A-671013.1 |
| 19 | To 5.1 M Cutting Table | 1 | 713506.2 | A-713506.2 |
| 21 | - | 1 | 603380.0 | A-603380.0 |
| 22 | - | 1 | 609762.0 | A-609762.0 |
| 23 | For Straw Distributor | 1 | 506671.1 | A-506671.1 |
| 24 | For Straw Distributor | 1 | 640653.1 | A-640653.1 |
| 25 | - | 1 | 644014.1 | A-644014.1 |
| 26 | - | 1 | 644015.1 | A-644015.1 |
| 27 | - | 1 | 644016.1 | A-644016.1 |
| 29 | - | 1 | 064168.2 | A-064168.2 |
| 30 | - | 1 | 233843.1 | A-233843.1 |
| 33 | For Maize | 2 | 061872.0 | A-061872.0 |
| 33 | For Grain | 1 | 061701.1 | A-061701.1 |
| 34 | For Straw Chopper | 1 | 061700.0 | A-061700.0 |
| 35 | - | 1 | 603247.1 | A-603247.1 |
| 36 | For Straw Chopper | 1 | 061700.0 | A-061700.0 |
| 37 | - | 1 | 644014.1 | A-644014.1 |
| 38 | Cylinder N=650-1500 Rpm | 1 | 628630.0 | A-628630.0 |
| 38 | Cylinder N=500-1400 Rpm | 1 | 644177.0 | A-644177.0 |
| 39 | From 6.0m Cutting Table | 1 | 670224.1 | A-670224.1 |
| 43 | - | 1 | 680334.1 | A-680334.1 |





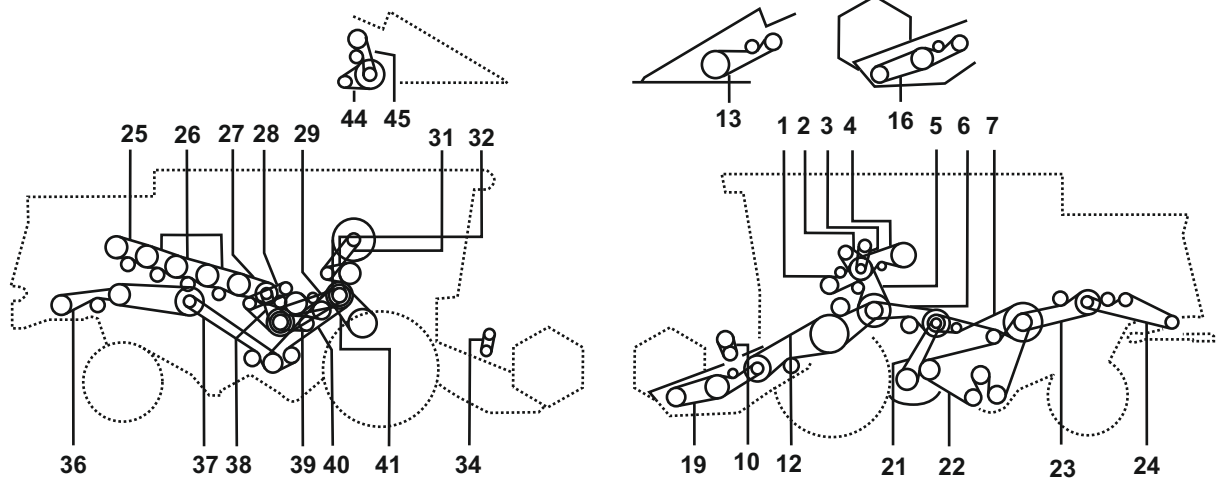

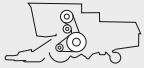
| Belt No. |  | No. of Belts | OEM  Part No. | PIX  Part No. |
|----------|---|--------------|--|--|
| 1 | Ground Drive | 1 | 644017.0 | A-644017.0 |
| 2 | Hydraulic Pump | 1 | 629002.1 | A-629002.1 |
| 3 | Air Conditioner | 1 | 629908.1 | A-629908.1 |
| 4 | Grain Tank Unloading | 1 | 629763.0 | A-629763.0 |
| 5 | Intermediate Drive Threshing Mechanism | 1 | 644018.1 | A-644018.1 |
| 6 | Intermediate Drive Blower | 1 | 603337.0 | A-603337.0 |
| 7 | Intermediate Drive Sieve Pan | 1 | 644141.1 | A-644141.1 |
| 10 | To 5.1 M Cutterbar | 1 | 670224.1 | A-670224.1 |
| 12 | Feeder Housing Cutterbar | 2 | 603017.3 | A-603017.3 |
| 13 | For Corn Picker | 1 | 692149.0 | A-692149.0 |
| 13 | For Corn Picker | 1 | 692150.0 | A-692150.0 |
| 16 | From 6.0 M Cutterbar | 1 | 671013.1 | A-671013.1 |
| 19 | To 5.1 M Cutterbar | 1 | 713506.2 | A-713506.2 |
| 21 | Blower - Variable Speed Drive | 1 | 603380.1 | A-603380.1 |
| 22 | Sieve Box | 1 | 609762.0 | A-609762.0 |
| 23 | Intermediate Drive Straw Distributor | 1 | 506671.2 | A-506671.2 |
| 24 | For Straw Spreader | 1 | 640653.1 | A-640653.1 |
| 25 | 8. Separator Drum | 1 | 644014.1 | A-644014.1 |
| 26 | 3.5, 6.7 Separator Drum | 4 | 644015.1 | A-644015.1 |
| 27 | 4th Separator Drum | 1 | 644016.1 | A-644016.1 |
| 29 | Intermediate Drive Drum Variable Speed | 1 | 064168.2 | A-064168.2 |
| 30 | Rotor Drive | 1 | 783430.1 | A-783430.1 |
| 30 | To No; 15800110 | 1 | 233843.1 | A-233843.1 |
| 33 | Chopper, Grain | 1 | 061701.2 | A-061701.2 |
| 33 | Chopper, Corn | 2 | 061872.0 | A-061872.0 |
| 34 | Intermediate Drive li Chopper | 1 | 061700.1 | A-061700.1 |
| 35 | Intermediate Drive Separator Drum | 1 | 603247.1 | A-603247.1 |
| 36 | Intermediate Drive I Chopper | 1 | 061700.1 | A-061700.1 |
| 37 | 1ste and 2nd Separator Drum | 1 | 644014.1 | A-644014.1 |
| 38 | At N = 650 - 1500 Min-1 | 1 | 628630.0 | A-628630.0 |
| 38 | At N = 500 - 1400 Min-1 | 1 | 644177.0 | A-644177.0 |
| 39 | From 6.0m Cutterbar | 1 | 670224.1 | A-670224.1 |
| 43 | For Hph - G Picker | 1 | 680334.1 | A-680334.1 |

CLAAS COMMANDOR 116 - 228

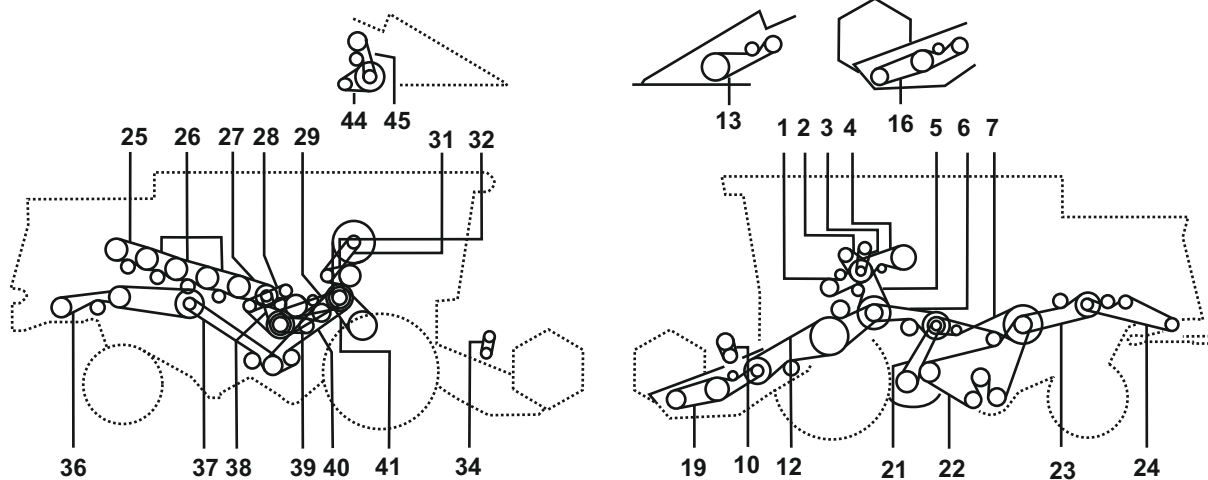

| Belt No. |  | No. of Belts | OEM  Part No. | PIX  Part No. |
|----------|---|--------------|--|--|
| 1 | Travel Drive (to Nr. 15900370) | 1 | 644017.0 | A-644017.0 |
| 1 | Travel Drive (from Nr. 15900371) | 1 | 661092.1 | A-661092.1 |
| 2 | Hydraulic Pump Drive (to Nr. 15900370) | 1 | 629002.1 | A-629002.1 |
| 2 | Hydraulic Pump Drive (from Nr. 15900371) | 1 | 633030.2 | A-633030.2 |
| 3 | Air Conditioning Compressor Drive | 1 | 629908.1 | A-629908.1 |
| 4 | Tank Unloading (from Nr. 15900371) | 1 | 661093.0 | A-661093.0 |
| 4 | Tank Unloading (to Nr. 15900370) | 1 | 629763.0 | A-629763.0 |
| 5 | Threshing Cylinder (to Nr. 15900370) | 1 | 644018.1 | A-644018.1 |
| 5 | Threshing Machine (from Nr. 15900371) | 1 | 644403.0 | A-644403.0 |
| 6 | Countershaft - Fan Drive | 1 | 603337.0 | A-603337.0 |
| 7 | Shaker Shoe Drive (from Nr. 15900371) | 1 | 644141.1 | A-644141.1 |
| 7 | Shaker Shoe Drive (to Nr. 15900370) | 1 | 603336.0 | A-603336.0 |
| 10 | Reel Drive By 5.1 M Cutting Table | 1 | 670224.1 | A-670224.1 |
| 12 | Conveyor Shaft 1463 Mm | 2 | 603017.3 | A-603017.3 |
| 12 | Conveyor Shaft 1306 Mm (to Nr. 15900460) | 1 | 603430.0 | A-603430.0 |
| 12 | Conveyor Shaft 1306 Mm (from Nr. 15900461) | 1 | 644419.0 | A-644419.0 |
| 13 | For Maize Picker | 1 | 692149.0 | A-692149.0 |
| 13 | For Maize Picker Hinged | 1 | 692150.0 | A-692150.0 |
| 13 | Cutting Table Drive (maize) | 1 | 629142.0 | A-629142.0 |
| 16 | Cutting Mechanical From 6.0 M Cutting Table | 1 | 671013.1 | A-671013.1 |
| 19 | Cutting Mechanical By 5.1 M Cutting Table | 1 | 713506.2 | A-713506.2 |
| 21 | Fan Drive Variable Speed | 1 | 603380.0 | A-603380.0 |
| 22 | Shaker Shoe Drive | 1 | 609762.0 | A-609762.0 |
| 23 | For Straw Distributor | 1 | 506671.1 | A-506671.1 |
| 23 | Distributor Grain | 1 | 713506.2 | A-713506.2 |
| 24 | Straw Distributor | 1 | 640653.1 | A-640653.1 |
| 25 | Separator Cylinder 8. | 1 | 644014.1 | A-644014.1 |
| 26 | Separator Cylinder 3. 5. 6. and 7 | 1 | 644015.1 | A-644015.1 |
| 27 | Separator Cylinder 4. | 1 | 644016.1 | A-644016.1 |
| 28 | Countershaft - Variator Drive | 1 | 064168.2 | A-064168.2 |
| 31 | Rotary Sieve Drive (to Nr. 15900370) | 1 | 644267.0 | A-644267.0 |
| 32 | Rotary Sieve Drive (to Nr. 15900150) | 1 | 633030.2 | A-633030.2 |
| 32 | Rotary Sieve Countershaft Nr. 15900151-15900370 | 1 | 233839.2 | A-233839.2 |
| 34 | Reel Drive From 6.0 M Cutting Table | 1 | 670224.1 | A-670224.1 |



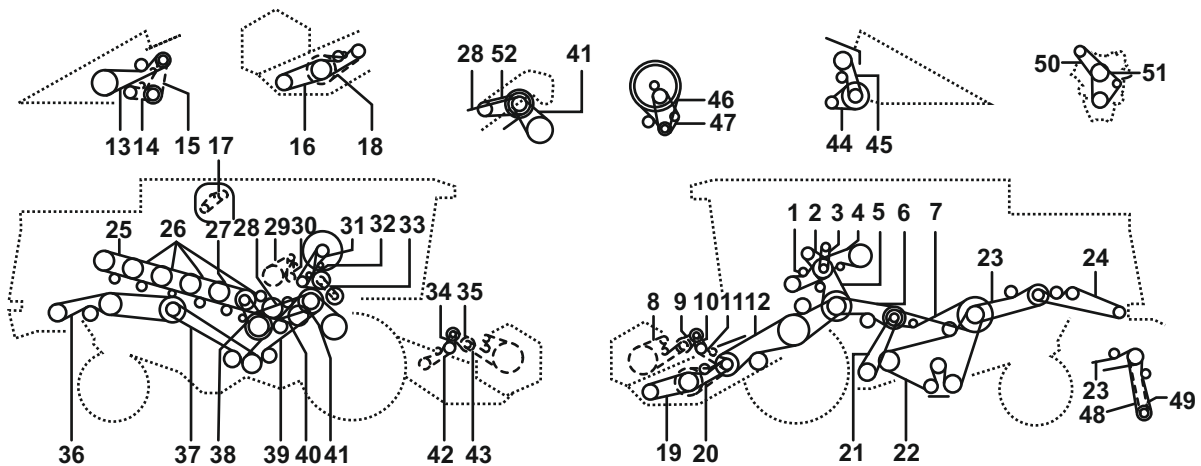

| Belt No. |  | No. of Belts | OEM  Part No. | PIX  Part No. |
|----------|---|--------------|--|--|
| 36 | Straw Chopper (maize) | 2 | 061872.0 | A-061872.0 |
| 36 | Straw Chopper (grain) | 1 | 061701.1 | A-061701.1 |
| 37 | Countershaft (2nd Stage) - Straw Chopper | 1 | 061700.0 | A-061700.0 |
| 38 | Countershaft - Straw Stripper Drum | 1 | 603247.1 | A-603247.1 |
| 39 | Countershaft (primary) - Straw Chopper | 1 | 061700.0 | A-061700.0 |
| 40 | 1. and 2. Separator Cylinder | 1 | 644014.1 | A-644014.1 |
| 41 | Cylinder N=650-1500 Rpm (to Nr. 15900310) | 1 | 628630.0 | A-628630.0 |
| 41 | Threshing Cylinder Rpm 650-1500 From 15900311 | 1 | 644418.0 | A-644418.0 |
| 41 | Threshing Cylinder With Two-stage Drive | 1 | 644418.1 | A-644418.1 |
| 41 | Cylinder N=500-1400 Rpm | 1 | 644177.0 | A-644177.0 |
| 45 | - | 1 | 680334.1 | A-680334.1 |
| 46 | Rotary Sieve (from Nr. 15900371) | 1 | 661345.0 | A-661345.0 |
| 47 | Rotary Sieve Countershaft (from Nr. 15900371) | 1 | 661245.0 | A-661245.0 |
| 48 | Distributor - N=531 Rpm (from Nr. 70910057) | 1 | 501925.0 | A-501925.0 |
| 48 | Distributor - N=531 Rpm (to Nr. 70910056) | 1 | 802931.0 | A-802931.0 |
| 49 | Distributor - N=676 Rpm (from Nr. 70910057) | 1 | 687046.0 | A-687046.0 |
| 49 | Distributor - N=676 Rpm (to Nr. 70910056) | 1 | 750288.0 | A-750288.0 |
| 50 | Alternator Drive (to Nr. 15900370) | 1 | 133528.0 | A-133528.0 |
| 50 | Alternator Drive (from Nr. 15900371) | 1 | 133640.0 | A-133640.0 |
| 51 | Waterpump Drive (from Nr. 15900370) | 1 | 133630.0 | A-133630.0 |

CLAAS COMMANDOR 116 CS

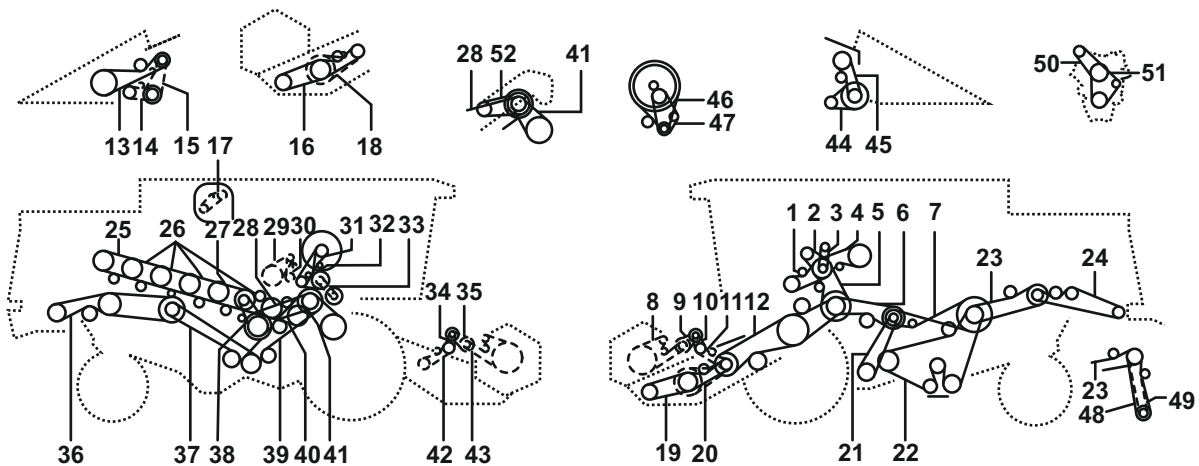

| Belt No. |  | No. of Belts | OEM  Part No. | PIX  Part No. |
|----------|---|--------------|--|--|
| 1 | Ground Drive From No. 15900371 | 1 | 661092.1 | A-661092.1 |
| 1 | To No. 15900370 | 1 | 644017.0 | A-644017.0 |
| 2 | Hydraulic Pump From No. 15900371 | 1 | 633030.2 | A-633030.2 |
| 2 | To No. 15900370 | 1 | 629002.1 | A-629002.1 |
| 3 | Air Conditioner | 1 | 629908.1 | A-629908.1 |
| 4 | Grain Tank Unloading From No. 15900371 | 1 | 661093.0 | A-661093.0 |
| 4 | To No. 15900370 | 1 | 629763.0 | A-629763.0 |
| 5 | Intermediate Drive Threshing Mechanism From No. 15900371 | 1 | 644403.0 | A-644403.0 |
| 5 | To No. 15900370 | 1 | 644018.1 | A-644018.1 |
| 6 | Blower Intermediate Drive | 1 | 603337.0 | A-603337.0 |
| 7 | Sieve Pan Intermediatedrive From No. 15900371 | 1 | 644141.1 | A-644141.1 |
| 7 | To No. 15900370 | 1 | 603336.1 | A-603336.1 |
| 10 | At 5.1 M Cutterbar | 1 | 670224.1 | A-670224.1 |
| 12 | Shafts Distance 1306 Mm From No. 15900461 | 2 | 644419.0 | A-644419.0 |
| 12 | Shafts Distance 1306 Mm To No. 15900460 | 2 | 603430.0 | A-603430.0 |
| 12 | Shafts Distance 1463 Mm | 2 | 603017.3 | A-603017.3 |
| 13 | For Corn Picker | 1 | 692149.0 | A-692149.0 |
| 13 | For Corn Picker | 1 | 692150.0 | A-692150.0 |
| 13 | Corn Picker Folding | 1 | 629142.0 | A-629142.0 |
| 16 | From 6.0 M Cutterbar | 1 | 671013.1 | A-671013.1 |
| 19 | At 5.1 M Cutterbar | 1 | 713506.2 | A-713506.2 |
| 21 | Fan | 1 | 603380.1 | A-603380.1 |
| 22 | Sieve Box | 1 | 609762.0 | A-609762.0 |
| 23 | For Straw Spreader | 1 | 506671.2 | A-506671.2 |
| 23 | For Chaff Spreader | 1 | 713506.2 | A-713506.2 |
| 24 | For Straw Spreader | 1 | 640653.1 | A-640653.1 |
| 25 | 8. Separator Drum | 1 | 644014.1 | A-644014.1 |
| 26 | 3.5, 6.7. Separator Drum | 4 | 644015.1 | A-644015.1 |
| 27 | 4th Separator Drum | 1 | 644016.1 | A-644016.1 |
| 28 | Intermediate Drive Variable Speed Drive | 1 | 064168.2 | A-064168.2 |
| 31 | Rotor Drive To No. 15900370 | 1 | 644267.0 | A-644267.0 |
| 32 | Rotor Intermediate Drive No 15900151 - 15900370 | 1 | 233839.2 | A-233839.2 |
| 32 | To No. 15900150 | 1 | 633030.2 | A-633030.2 |

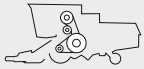



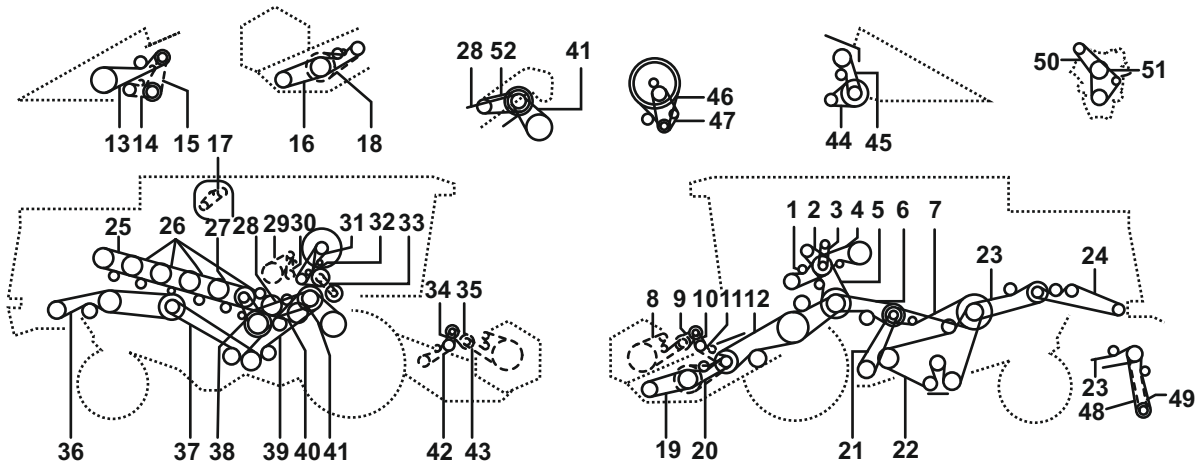

| Belt No. |  | No. of Belts | OEM  Part No. | PIX  Part No. |
|----------|---|--------------|--|--|
| 34 | From 6.0m Cutterbar | 1 | 670224.1 | A-670224.1 |
| 36 | Chopper, Grain | 1 | 061701.2 | A-061701.2 |
| 36 | Chopper, Corn | 2 | 061872.0 | A-061872.0 |
| 37 | Intermediate Drive li Chopper | 1 | 061700.1 | A-061700.1 |
| 38 | Intermediate Drive Separator Drum | 1 | 603247.1 | A-603247.1 |
| 39 | Intermediate Drive I Chopper | 1 | 061700.1 | A-061700.1 |
| 40 | 1ste and 2nd Separator Drum | 1 | 644014.1 | A-644014.1 |
| 41 | At N = 650 - 1500 Min-1 From No. 15900581 | 1 | 661429.0 | A-661429.0 |
| 41 | At N = 650 - 1500 Min-1 No. 15900311 - 15900580 | 1 | 644418.0 | A-644418.0 |
| 41 | To No. 15900310 | 1 | 628630.0 | A-628630.0 |
| 41 | At N = 500 - 1500 Min-1 | 1 | 661430.0 | A-661430.0 |
| 41 | At High - Low Speed Range Transmission From No. 15900581 | 1 | 661429.0 | A-661429.0 |
| 41 | At Drum Chain Drive | 1 | 644418.0 | A-644418.0 |
| 45 | Rotor Drive From No. 15900371 | 1 | 680334.1 | A-680334.1 |
| 46 | Rotor Intermediate Drive From No. 15900371 | 1 | 661345.0 | A-661345.0 |
| 47 | Rotor Intermediate Drive From No. 15900371 | 1 | 661245.0 | A-661245.0 |
| 48 | For Chaff Spreader From No.70910057 At 531 Min-1 | 1 | 501925.0 | A-501925.0 |
| 48 | For Chaff Spreader To No. 70910056 At 531 Min-1 | 1 | 802931.0 | A-802931.0 |
| 49 | For Chaff Spreader From No.70910057 At 676 Min-1 | 1 | 687046.1 | A-687046.1 |
| 49 | For Chaff Spreader To No. 70910056 At 676 Min-1 | 1 | 750288.0 | A-750288.0 |
| 50 | For Alternator From No. 15900371 | 1 | 133640.0 | A-133640.0 |
| 50 | To No. 15900370 | 1 | 133528.0 | A-133528.0 |
| 51 | For Water pump To No. 15900370 | 1 | 133630.1 | A-133630.1 |
| 52 | Radiator Concave Suction From No. 15900371 | 1 | 644448.0 | A-644448.0 |

CLAAS COMMANDOR 228 CS

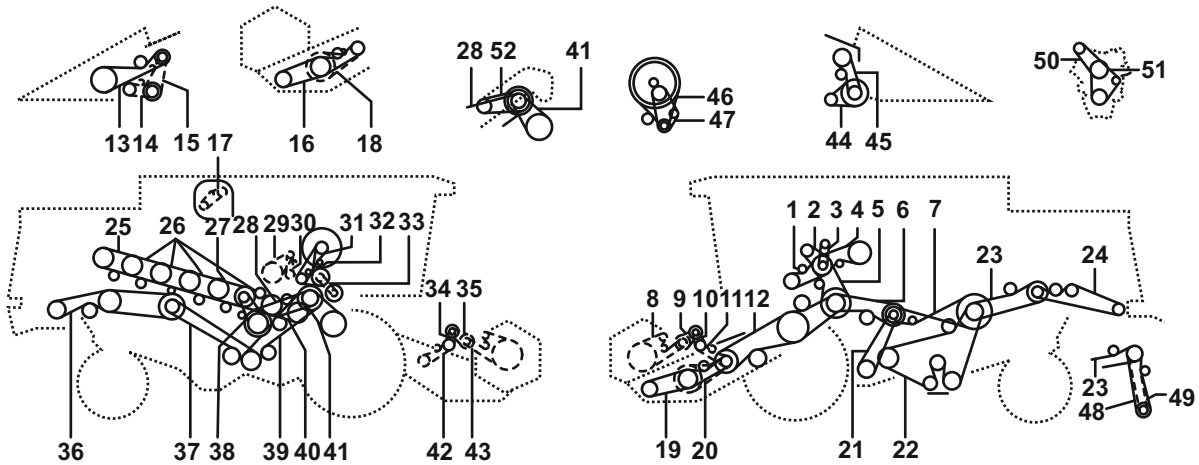



| Belt No. |  | No. of Belts | OEM  Part No. | PIX  Part No. |
|----------|---|--------------|--|--|
| 1 | Ground Drive From No. 15900371 | 1 | 661092.1 | A-661092.1 |
| 1 | To No. 15900370 | 1 | 644017.0 | A-644017.0 |
| 2 | Hydraulic Pump From No. 15900371 | 1 | 633030.2 | A-633030.2 |
| 2 | To No. 15900370 | 1 | 629002.1 | A-629002.1 |
| 3 | Air Conditioner | 1 | 629908.1 | A-629908.1 |
| 4 | Grain Tank Unloading From No. 15900371 | 1 | 661093.0 | A-661093.0 |
| 4 | To No. 15900370 | 1 | 629763.0 | A-629763.0 |
| 5 | Intermediate Drive Threshing Mechanism From No. 15900371 | 1 | 644403.0 | A-644403.0 |
| 5 | To No. 15900370 | 1 | 644018.1 | A-644018.1 |
| 6 | Blower Intermediate Drive | 1 | 603337.0 | A-603337.0 |
| 7 | Sieve Pan Intermediatedrive From No. 15900371 | 1 | 644141.1 | A-644141.1 |
| 7 | To No. 15900370 | 1 | 603336.1 | A-603336.1 |
| 10 | At 5.1 M Cutterbar | 1 | 670224.1 | A-670224.1 |
| 12 | Shafts Distance 1306 Mm From No. 15900461 | 2 | 644419.0 | A-644419.0 |
| 12 | Shafts Distance 1306 Mm To No. 15900460 | 2 | 603430.0 | A-603430.0 |
| 12 | Shafts Distance 1463 Mm | 2 | 603017.3 | A-603017.3 |
| 13 | For Corn Picker | 1 | 692149.0 | A-692149.0 |
| 13 | For Corn Picker | 1 | 692150.0 | A-692150.0 |
| 13 | Corn Picker Folding | 1 | 629142.0 | A-629142.0 |
| 16 | From 6.0 M Cutterbar | 1 | 671013.1 | A-671013.1 |
| 19 | At 5.1 M Cutterbar | 1 | 713506.2 | A-713506.2 |
| 21 | Fan | 1 | 603380.1 | A-603380.1 |
| 22 | Sieve Box | 1 | 609762.0 | A-609762.0 |
| 23 | For Straw Spreader | 1 | 506671.2 | A-506671.2 |
| 23 | For Chaff Spreader | 1 | 713506.2 | A-713506.2 |
| 24 | For Straw Spreader | 1 | 640653.1 | A-640653.1 |
| 25 | 8. Separator Drum | 1 | 644014.1 | A-644014.1 |
| 26 | 3.5, 6.7. Separator Drum | 4 | 644015.1 | A-644015.1 |
| 27 | 4th Separator Drum | 1 | 644016.1 | A-644016.1 |
| 28 | Intermediate Drive Variable Speed Drive | 1 | 064168.2 | A-064168.2 |
| 31 | Rotor Drive To No. 15900370 | 1 | 644267.0 | A-644267.0 |
| 32 | Rotor Intermediate Drive No 15900151 - 15900370 | 1 | 233839.2 | A-233839.2 |
| 32 | To No. 15900150 | 1 | 633030.2 | A-633030.2 |



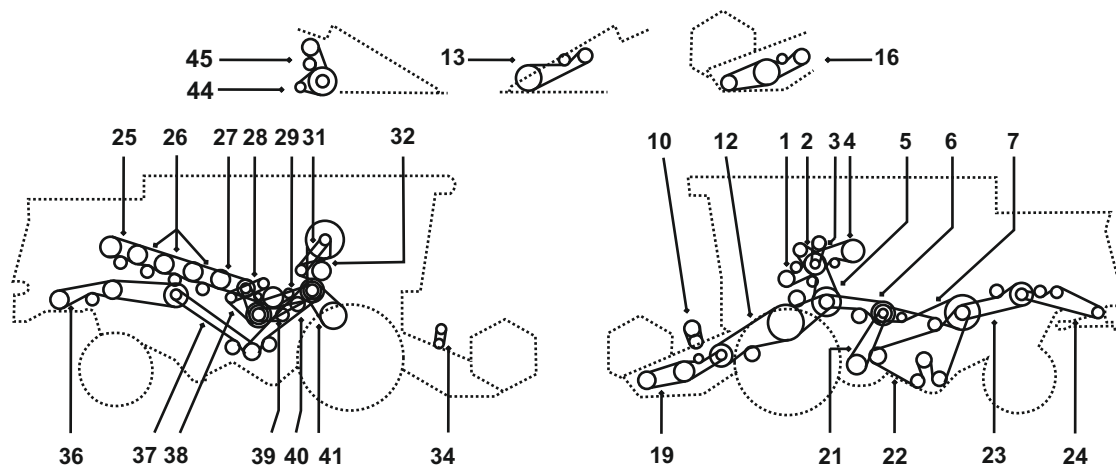

| Belt No. |  | No. of Belts | OEM  Part No. | PIX  Part No. |
|----------|---|--------------|--|--|
| 34 | From 6.0m Cutterbar | 1 | 670224.1 | A-670224.1 |
| 36 | Chopper, Grain | 1 | 061701.2 | A-061701.2 |
| 36 | Chopper, Corn | 2 | 061872.0 | A-061872.0 |
| 37 | Intermediate Drive li Chopper | 1 | 061700.1 | A-061700.1 |
| 38 | Intermediate Drive Separator Drum | 1 | 603247.1 | A-603247.1 |
| 39 | Intermediate Drive l Chopper | 1 | 061700.1 | A-061700.1 |
| 40 | 1ste and 2nd Separator Drum | 1 | 644014.1 | A-644014.1 |
| 41 | At N = 650 - 1500 Min-1 From No. 15900581 | 1 | 661429.0 | A-661429.0 |
| 41 | At N = 650 - 1500 Min-1 No. 15900311 - 15900580 | 1 | 644418.0 | A-644418.0 |
| 41 | To No. 15900310 | 1 | 628630.0 | A-628630.0 |
| 41 | At N = 500 - 1500 Min-1 | 1 | 661430.0 | A-661430.0 |
| 41 | At High - Low Speed Range Transmission From No. 15900581 | 1 | 661429.0 | A-661429.0 |
| 41 | At Drum Chain Drive | 1 | 644418.0 | A-644418.0 |
| 45 | Rotor Drive From No. 15900371 | 1 | 680334.1 | A-680334.1 |
| 46 | Rotor Intermediate Drive From No. 15900371 | 1 | 661345.0 | A-661345.0 |
| 47 | Rotor Intermediate Drive From No. 15900371 | 1 | 661245.0 | A-661245.0 |
| 48 | For Chaff Spreader From No. 70910057 At 531 Min-1 | 1 | 501925.0 | A-501925.0 |
| 48 | For Chaff Spreader To No. 70910056 At 531 Min-1 | 1 | 802931.0 | A-802931.0 |
| 49 | For Chaff Spreader From No. 70910057 At 676 Min-1 | 1 | 687046.1 | A-687046.1 |
| 49 | For Chaff Spreader To No. 70910056 At 676 Min-1 | 1 | 750288.0 | A-750288.0 |
| 50 | For Alternator From No. 15900371 | 1 | 133640.0 | A-133640.0 |
| 50 | To No. 15900370 | 1 | 133528.0 | A-133528.0 |
| 51 | For Waterpump To No. 15900370 | 1 | 133630.1 | A-133630.1 |
| 52 | Radiator Concave Suction From No. 15900371 | 1 | 644448.0 | A-644448.0 |



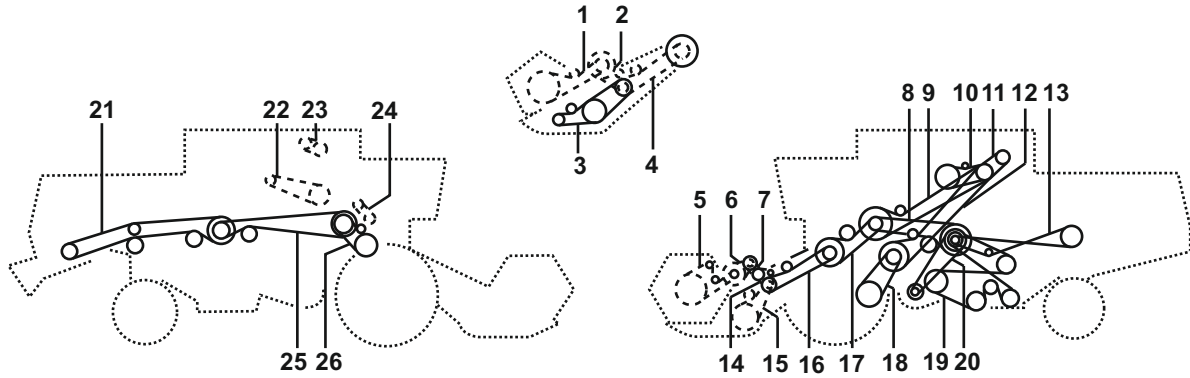

| Belt No. |  | No. of Belts | OEM  Part No. | PIX  Part No. |
|----------|---|--------------|--|--|
| 1 | Cutting Table Drive | 1 | 702509.0 | A-702509.0 |
| 2 | Cylinder Drive | 1 | 702536.0 | A-702536.0 |
| 3 | Reel Drive Variable Speed | 1 | 778561.0 | A-778561.0 |
| 4 | Knife Drive | 1 | 778717.0 | A-778717.0 |
| 5 | Shaker Shoe Drive | 2 | 610830.0 | A-610830.0 |
| 6 | Traction Variator Drive | 1 | 702536.0 | A-702536.0 |
| 7 | Countershaft Drive | 1 | 703314.0 | A-703314.0 |
| 8 | Unloading Grain Tank | 1 | 706087.0 | A-706087.0 |
| 9 | Straw Spreader Drive | 1 | 706829.0 | A-706829.0 |
| 10 | Hydraulic Pump Drive | 1 | 713506.0 | A-713506.0 |
| 11 | Traction Drive | 1 | 720695.0 | A-720695.0 |
| 12 | Turning Drum Drive | 1 | 720696.0 | A-720696.0 |
| 12 | Turning Drum Drive | 1 | 720866.0 | A-720866.0 |
| 13 | Radiator Fan Drive | 1 | 721306.0 | A-721306.0 |
| 13 | Radiator Fan Drive | 1 | 721307.0 | A-721307.0 |
| 14 | Straw Walker Drive | 1 | 774099.0 | A-774099.0 |
| 15 | Fan Mill Variable Speed | 1 | 778561.0 | A-778561.0 |





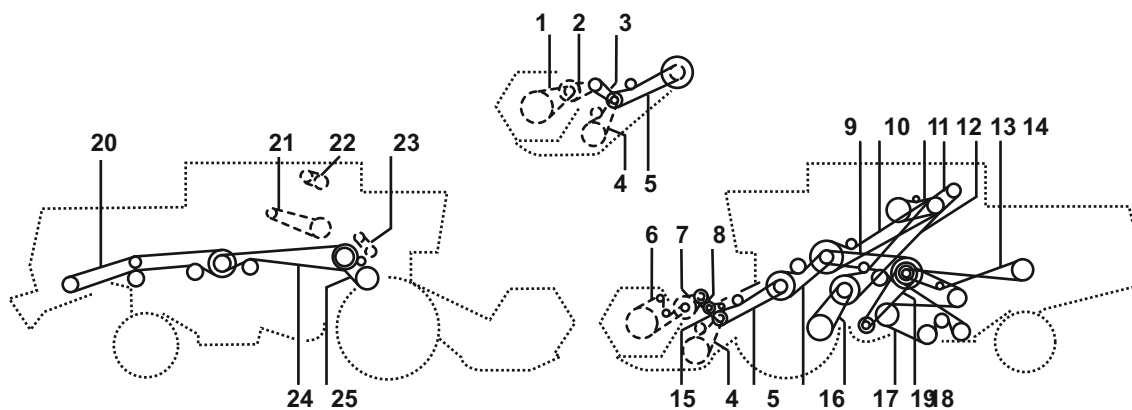

| Belt No. |  | No. of Belts | OEM  Part No. | PIX  Part No. |
|----------|---|--------------|--|--|
| 3 | To No. 15200469 | 1 | 785341.0 | A-785341.0 |
| 6 | From Cutterbar247185 | 1 | 670224.1 | A-670224.1 |
| 8 | Fanning Mill | 1 | 724141.0 | A-724141.0 |
| 9 | For Threshing Mechanism | 1 | 724101.0 | A-724101.0 |
| 10 | - | 1 | 724179.0 | A-724179.0 |
| 11 | Hydraulic Pump | 1 | 767057.1 | A-767057.1 |
| 12 | For Ground Drive | 1 | 724180.0 | A-724180.0 |
| 13 | Straw Walker | 1 | 785176.0 | A-785176.0 |
| 16 | From Cutterbar247185 | 1 | 724301.0 | A-724301.0 |
| 17 | From No. 15200690 | 1 | 724339.0 | A-724339.0 |
| 17 | To No. 15200689 | 1 | 724168.0 | A-724168.0 |
| 18 | From No. 15201320 | 1 | 671083.0 | A-671083.0 |
| 18 | To No. 15201319 | 1 | 629756.0 | A-629756.0 |
| 19 | - | 1 | 724248.1 | A-724248.1 |
| 20 | - | 1 | 603380.1 | A-603380.1 |
| 21 | - | 1 | 061878.0 | A-061878.0 |
| 25 | Straw Chopper | 2 | 061872.0 | A-061872.0 |
| 26 | - | 1 | 603247.1 | A-603247.1 |

CLAAS DOMINATOR 48

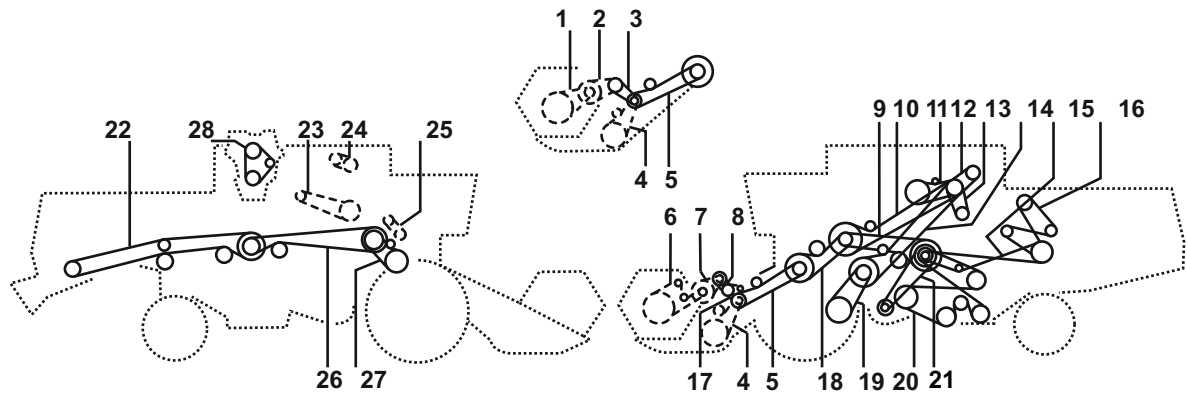





| Belt No. | | No. of Belts | OEM  Part No. | PIX  Part No. |
|----------|---|--------------|--|--|
| 3 | - | 1 | 778561.0 | A-778561.0 |
| 5 | - | 1 | 724301.0 | A-724301.0 |
| 8 | - | 1 | 670224.0 | A-670224.0 |
| 9 | - | 1 | 724141.0 | A-724141.0 |
| 10 | - | 1 | 724101.0 | A-724101.0 |
| 11 | - | 1 | 673614.0 | A-673614.0 |
| 12 | - | 1 | 767057.0 | A-767057.0 |
| 13 | - | 1 | 724180.0 | A-724180.0 |
| 14 | - | 1 | 785176.0 | A-785176.0 |
| 16 | - | 1 | 724168.0 | A-724168.0 |
| 17 | - | 1 | 629756.0 | A-629756.0 |
| 18 | - | 1 | 724248.0 | A-724248.0 |
| 19 | - | 1 | 603380.0 | A-603380.0 |
| 24 | - | 2 | 061872.0 | A-061872.0 |
| 25 | - | 1 | 603247.0 | A-603247.0 |
| 25 | - | 1 | 603015.0 | A-603015.0 |



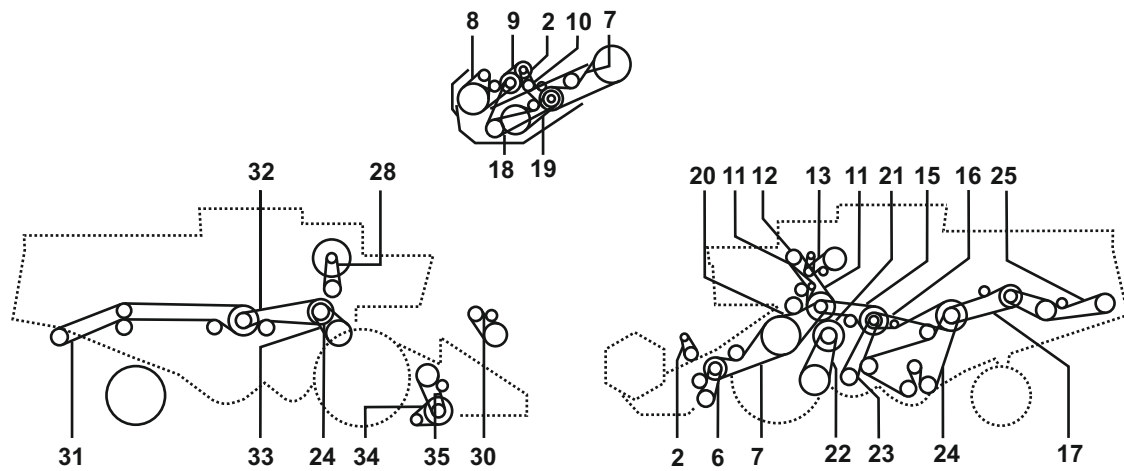

| Belt No. |  | No. of Belts | OEM  Part No. | PIX  Part No. |
|----------|---|--------------|--|--|
| 3 | To Cutterbar 247184 | 1 | 778561.0 | A-778561.0 |
| 5 | - | 1 | 724301.0 | A-724301.0 |
| 8 | From Cutterbar247185 | 1 | 670224.1 | A-670224.1 |
| 9 | Fanning Mill | 1 | 724141.0 | A-724141.0 |
| 10 | For Threshing Mechanism | 1 | 724100.0 | A-724100.0 |
| 11 | - | 1 | 673614.1 | A-673614.1 |
| 12 | Hydraulic Pump | 1 | 767057.1 | A-767057.1 |
| 13 | From Cutterbar247185 | 1 | 783268.1 | A-783268.1 |
| 14 | From No. 15400642 | 1 | 724180.0 | A-724180.0 |
| 15 | To No. 15400641 | 1 | 785176.0 | A-785176.0 |
| 16 | - | 1 | 802931.0 | A-802931.0 |
| 18 | - | 1 | 724339.0 | A-724339.0 |
| 18 | - | 1 | 724168.0 | A-724168.0 |
| 19 | - | 1 | 629756.0 | A-629756.0 |
| 20 | - | 1 | 724247.1 | A-724247.1 |
| 21 | - | 1 | 603380.1 | A-603380.1 |
| 22 | - | 1 | 061902.0 | A-061902.0 |
| 26 | Straw Chopper | 2 | 061872.0 | A-061872.0 |
| 27 | At N = 650 - 1500 Min-1 From No. 15400932 | 1 | 661429.0 | A-661429.0 |
| 27 | At N = 650 - 1500 Min-1 To No 15400931 | 1 | 603015.1 | A-603015.1 |
| 27 | At N = 500 - 1400 Min-1 | 1 | 661430.0 | A-661430.0 |
| 28 | Perkins 4.236 / 4.248 | 1 | 147227.0 | A-147227.0 |
| 28 | Perkins 6.3544 | 2 | 147228.1 | A-147228.1 |
| 28 | Perkins 1006.6 | 1 | 147233.1 | A-147233.1 |

CLAAS DOMINATOR 56 - 66



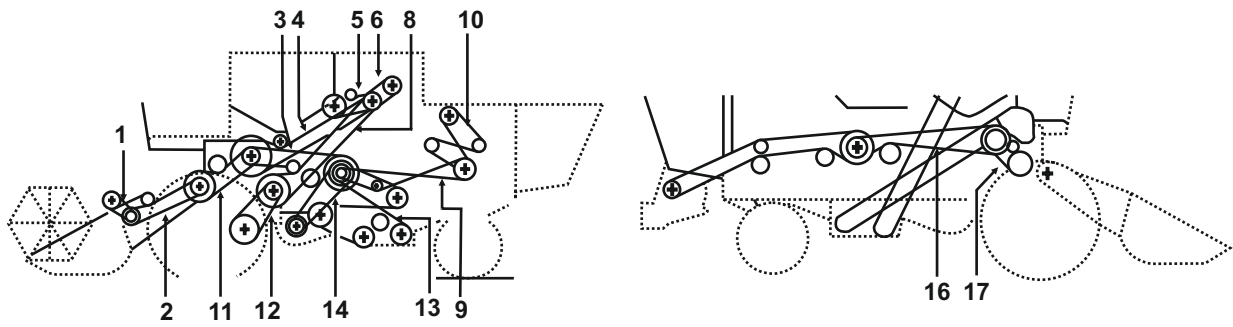

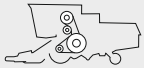

| Belt No. |  | No. of Belts | OEM  Part No. | PIX  Part No. |
|----------|---|--------------|--|--|
| 2 | Reel Drive Variable Speed | 1 | 670224.0 | A-670224.0 |
| 6 | Knife Drive | 1 | 629214.0 | A-629214.0 |
| 7 | - | 1 | 629081.0 | A-629081.0 |
| 7 | - | 1 | 603122.0 | A-603122.0 |
| 8 | - | 1 | 603284.0 | A-603284.0 |
| 9 | - | 1 | 056961.0 | A-056961.0 |
| 10 | - | 1 | 056961.0 | A-056961.0 |
| 11 | Hydraulic Pump Drive | 1 | 767057.1 | A-767057.1 |
| 12 | - | 1 | 621903.0 | A-621903.0 |
| 13 | Discharge Auger Shaft | 1 | 673614.0 | A-673614.0 |
| 14 | Traction Drive | 1 | 671012.0 | A-671012.0 |
| 15 | - | 1 | 603337.0 | A-603337.0 |
| 15 | - | 1 | 672358.0 | A-672358.0 |
| 16 | Sieve Drive | 1 | 672359.0 | A-672359.0 |
| 16 | - | 1 | 603336.0 | A-603336.0 |
| 17 | - | 1 | 506671.1 | A-506671.1 |
| 18 | - | 1 | 603283.0 | A-603283.0 |
| 19 | - | 1 | 603048.0 | A-603048.0 |
| 20 | - | 1 | 673638.1 | A-673638.1 |
| 21 | - | 1 | 629436.0 | A-629436.0 |
| 22 | - | 1 | 629737.0 | A-629737.0 |
| 23 | - | 1 | 671209.0 | A-671209.0 |
| 24 | - | 2 | 603017.3 | A-603017.3 |
| 25 | - | 1 | 635494.0 | A-635494.0 |
| 28 | - | 1 | 783430.1 | A-783430.1 |
| 30 | - | 1 | 603247.0 | A-603247.0 |
| 31 | - | 1 | 061361.0 | A-061361.0 |
| 32 | Wheel Shaft (front) | 1 | 060306.2 | A-060306.2 |
| 33 | - | 1 | 603015.1 | A-603015.1 |
| 34 | - | 1 | 629410.0 | A-629410.0 |
| 35 | - | 1 | 680334.1 | A-680334.1 |



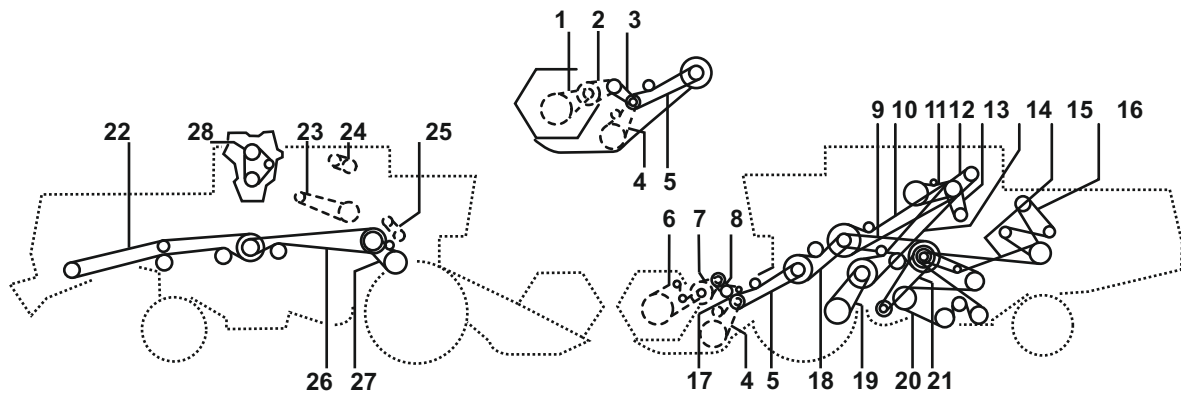

| Belt No. |  | No. of Belts | OEM  Part No. | PIX  Part No. |
|----------|---|--------------|--|--|
| 1 | Pick Up Reel | 1 | 778561.0 | A-778561.0 |
| 2 | Cutterbar Drive | 1 | 724301.0 | A-724301.0 |
| 3 | Fanning Mill | 1 | 724141.0 | A-724141.0 |
| 4 | Threshing Drive Mech. | 1 | 724100.0 | A-724100.0 |
| 5 | Grain Tank Unloader Drive | 1 | 673614.0 | A-673614.0 |
| 6 | Hydraulic Pump Drive | 1 | 767057.0 | A-767057.0 |
| 7 | Compressor Drive | 2 | 783268.1 | A-783268.1 |
| 8 | Fan Drive | 1 | 724180.0 | A-724180.0 |
| 8 | Fan Drive | 1 | 724181.0 | A-724181.0 |
| 9 | Straw Walker Drive | 1 | 785176.0 | A-785176.0 |
| 10 | Air Intake | 1 | 802931.0 | A-802931.0 |
| 11 | Feeder Drive | 1 | 724339.0 | A-724339.0 |
| 11 | Feeder Drive | 1 | 724168.0 | A-724168.0 |
| 12 | Traction Drive | 1 | 629756.0 | A-629756.0 |
| 13 | Impellor Drive | 1 | 724247.0 | A-724247.0 |
| 14 | Cleaning Fan | 1 | 603380.0 | A-603380.0 |
| 15 | Chopper Drive | 1 | 061902.0 | A-061902.0 |
| 16 | Final Chopper Drive | 2 | 061872.0 | A-061872.0 |
| 17 | Variator Drum Drive | 1 | 603015.1 | A-603015.1 |
| 17 | Variator Drum Drive | 1 | 628630.0 | A-628630.0 |

CLAAS DOMINATOR 58 SP



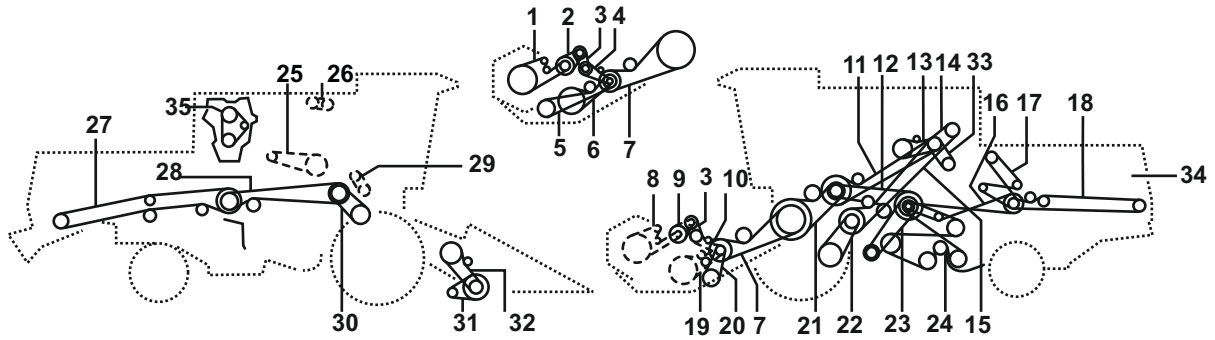

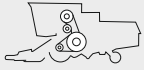
| Belt No. |  | No. of Belts | OEM  Part No. | PIX  Part No. |
|----------|---|--------------|--|--|
| 3 | To Cutterbar 247184 | 1 | 778561.0 | A-778561.0 |
| 5 | - | 1 | 724301.0 | A-724301.0 |
| 8 | From Cutterbar 247185 | 1 | 670224.1 | A-670224.1 |
| 9 | Fanning Mill | 1 | 724141.0 | A-724141.0 |
| 10 | For Threshing Mechanism | 1 | 724100.0 | A-724100.0 |
| 11 | - | 1 | 673614.1 | A-673614.1 |
| 12 | Hydraulic Pump | 1 | 767057.1 | A-767057.1 |
| 13 | From Cutterbar 247185 | 1 | 783268.1 | A-783268.1 |
| 14 | From No. 15400642 | 1 | 724180.0 | A-724180.0 |
| 15 | To No. 15400641 | 1 | 785176.0 | A-785176.0 |
| 16 | - | 1 | 802931.0 | A-802931.0 |
| 18 | - | 1 | 724339.0 | A-724339.0 |
| 18 | - | 1 | 724168.0 | A-724168.0 |
| 19 | - | 1 | 629756.0 | A-629756.0 |
| 20 | - | 1 | 724247.1 | A-724247.1 |
| 21 | - | 1 | 603380.1 | A-603380.1 |
| 22 | - | 1 | 061902.0 | A-061902.0 |
| 26 | Straw Chopper | 2 | 061872.0 | A-061872.0 |
| 27 | At N = 650 - 1500 Min-1 From No. 15400932 | 1 | 661429.0 | A-661429.0 |
| 27 | At N = 650 - 1500 Min-1 To No 15400931 | 1 | 603015.1 | A-603015.1 |
| 27 | At N = 500 - 1400 Min-1 | 1 | 661430.0 | A-661430.0 |
| 28 | Perkins 4.236 / 4.248 | 1 | 147227.0 | A-147227.0 |
| 28 | Perkins 6.3544 | 2 | 147228.1 | A-147228.1 |
| 28 | Perkins 1006.6 | 1 | 147233.1 | A-147233.1 |



| Belt No. |  | No. of Belts | OEM  Part No. | PIX  Part No. |
|----------|---|--------------|--|--|
| 1 | Cutting Mechanical By 3.0 M | 1 | 603284.0 | A-603284.0 |
| 2 | Cutting Mechanical By 3.0 M | 1 | 056961.0 | A-056961.0 |
| 3 | - | 1 | 670224.1 | A-670224.1 |
| 4 | Cutting Mechanical By 3.0 M | 1 | 056961.0 | A-056961.0 |
| 5 | For 3.6 M - 5.1 M To Cutting Mechanical 255807 | 1 | 713506.2 | A-713506.2 |
| 5 | Cutting Mechanical By 3.6 M To 5.1m To 25580 | 1 | 713506.2 | A-713506.2 |
| 5 | To Cutting Mechanical By 3.0 To Cut. 255807 | 2 | 778717.1 | A-778717.1 |
| 5 | Cutting Mechanical By 3.0 M To Cut. 255806 | 1 | 603283.0 | A-603283.0 |
| 6 | Cutting Mechanical By 3.0 M | 1 | 603048.0 | A-603048.0 |
| 7 | 2x By Maize Picket (to Nr. 15606082) | 2 | 629836.0 | A-629836.0 |
| 7 | 2x By Maize Picket (to Nr. 15606083) | 1 | 603290.0 | A-603290.0 |
| 11 | - | 1 | 724100.0 | A-724100.0 |
| 12 | - | 1 | 724141.0 | A-724141.0 |
| 13 | - | 1 | 673614.0 | A-673614.0 |
| 14 | - | 1 | 767057.1 | A-767057.1 |
| 15 | - | 1 | 724181.0 | A-724181.0 |
| 16 | - | 1 | 785176.0 | A-785176.0 |
| 17 | - | 1 | 802931.0 | A-802931.0 |
| 18 | For Straw Distributor | 1 | 509435.0 | A-509435.0 |
| 20 | Cutting Mechanical To 3.6 M | 1 | 629214.1 | A-629214.1 |
| 21 | - | 1 | 673638.1 | A-673638.1 |
| 22 | - | 1 | 629756.0 | A-629756.0 |
| 23 | - | 1 | 603380.1 | A-603380.1 |
| 24 | - | 1 | 724247.1 | A-724247.1 |
| 27 | For Grain | 1 | 061902.0 | A-061902.0 |
| 27 | For Maize | 1 | 062043.0 | A-062043.0 |
| 28 | - | 2 | 061872.0 | A-061872.0 |
| 30 | For N=650-1500 Rpm (to Nr. 15603257) | 1 | 628630.0 | A-628630.0 |
| 30 | For N=650-1550 Rpm (to Nr. 15603256) | 1 | 603015.1 | A-603015.1 |
| 30 | For N=500-1400 Rpm | 1 | 644177.0 | A-644177.0 |
| 31 | - | 1 | 629410.0 | A-629410.0 |
| 32 | - | 1 | 680334.1 | A-680334.1 |
| 33 | Air Conditioning Compressor Drive | 1 | 783268.1 | A-783268.1 |

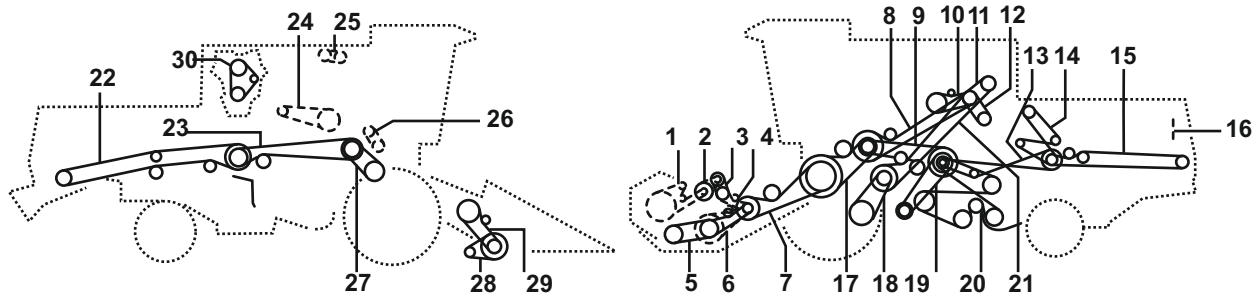

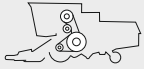
CLAAS DOMINATOR 68 R



| Belt No. |  | No. of Belts | OEM  Part No. | PIX  Part No. |
|----------|---|--------------|--|--|
| 3 | Reek Variator | 1 | 670224.1 | A-670224.1 |
| 5 | Knife Drive | 1 | 713506.2 | A-713506.2 |
| 7 | From No. 15500594 (2x For Corn) | 1 | 603290.0 | A-603290.0 |
| 7 | Feeder Drive To No. 15500593 (2x For Corn) | 2 | 629836.0 | A-629836.0 |
| 7 | Feeder Housing Long | 2 | 061872.0 | A-061872.0 |
| 8 | - | 1 | 724100.0 | A-724100.0 |
| 9 | Fanning Mill | 1 | 724141.0 | A-724141.0 |
| 10 | Grain Tank Unloading | 1 | 673614.0 | A-673614.0 |
| 11 | Hydraulic Pump | 1 | 767057.1 | A-767057.1 |
| 12 | Air Conditioner | 1 | 783268.1 | A-783268.1 |
| 13 | - | 1 | 785176.0 | A-785176.0 |
| 14 | Feed Rake Drive | 1 | 802931.0 | A-802931.0 |
| 15 | Straw Spreader | 1 | 509435.0 | A-509435.0 |
| 17 | Cutterbar Drive | 1 | 673638.1 | A-673638.1 |
| 18 | Drive - Variator | 1 | 629756.0 | A-629756.0 |
| 19 | Blower - Variator | 1 | 603380.1 | A-603380.1 |
| 20 | Sieve Pan Drive | 1 | 724247.1 | A-724247.1 |
| 21 | Ground Drive | 1 | 724181.0 | A-724181.0 |
| 22 | At Grain | 1 | 061902.0 | A-061902.0 |
| 22 | At Corn | 1 | 062043.0 | A-062043.0 |
| 23 | Straw Chopper | 2 | 061872.0 | A-061872.0 |
| 27 | At N = 650 - 1550 Min-1 | 1 | 603015.1 | A-603015.1 |
| 27 | At N = 500 - 1400 Min-1 | 1 | 644177.0 | A-644177.0 |
| 27 | At N = 650 - 1500 Min-1 | 1 | 628630.0 | A-628630.0 |
| 28 | For Hph - Chopper | 1 | 629410.0 | A-629410.0 |
| 29 | For Hph - Chopper | 1 | 680334.1 | A-680334.1 |
| 30 | Perkins 6.3544 | 2 | 147228.1 | A-147228.1 |
| 30 | Perkins 1006.6 | 1 | 147233.1 | A-147233.1 |
| 30 | Mercedes Om 352 | 1 | 133523.0 | A-133523.0 |

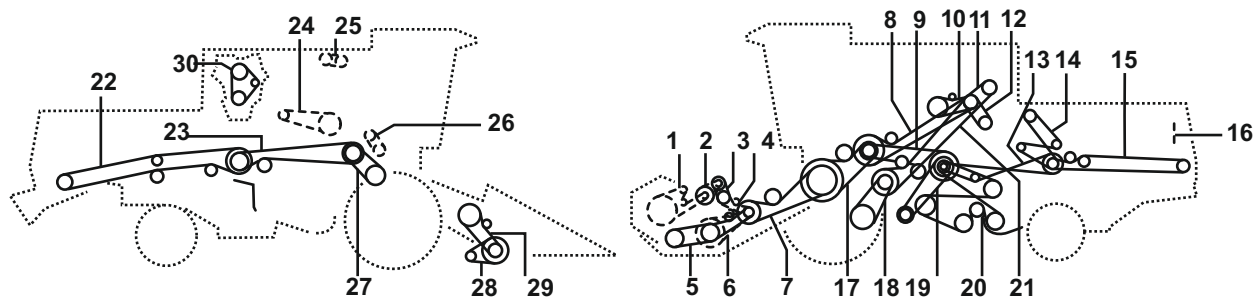

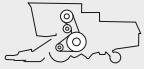
CLAAS DOMINATOR 68 SR



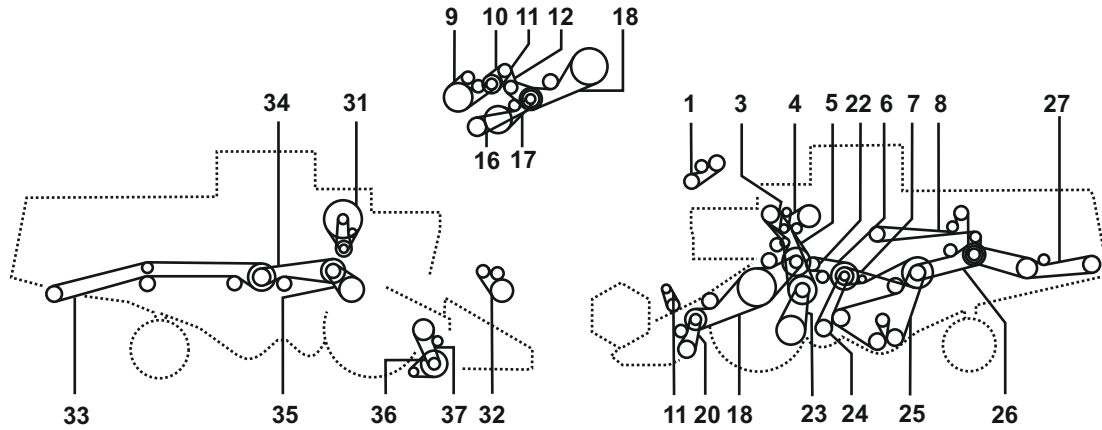

| Belt No. |  | No. of Belts | OEM  Part No. | PIX  Part No. |
|----------|---|--------------|--|--|
| 3 | Reek Variator | 1 | 670224.1 | A-670224.1 |
| 5 | Knife Drive | 1 | 713506.2 | A-713506.2 |
| 7 | From No. 15500594 (2x For Corn) | 1 | 603290.0 | A-603290.0 |
| 7 | Feeder Drive To No. 15500593 (2x For Corn) | 2 | 629836.0 | A-629836.0 |
| 7 | Feeder Housing Long | 2 | 061872.0 | A-061872.0 |
| 8 | - | 1 | 724100.0 | A-724100.0 |
| 9 | Fanning Mill | 1 | 724141.0 | A-724141.0 |
| 10 | Grain Tank Unloading | 1 | 673614.0 | A-673614.0 |
| 11 | Hydraulic Pump | 1 | 767057.1 | A-767057.1 |
| 12 | Air Conditioner | 1 | 783268.1 | A-783268.1 |
| 13 | - | 1 | 785176.0 | A-785176.0 |
| 14 | Feed Rake Drive | 1 | 802931.0 | A-802931.0 |
| 15 | Straw Spreader | 1 | 509435.0 | A-509435.0 |
| 17 | Cutterbar Drive | 1 | 673638.1 | A-673638.1 |
| 18 | Drive - Variator | 1 | 629756.0 | A-629756.0 |
| 19 | Blower - Variator | 1 | 603380.1 | A-603380.1 |
| 20 | Sieve Pan Drive | 1 | 724247.1 | A-724247.1 |
| 21 | Ground Drive | 1 | 724181.0 | A-724181.0 |
| 22 | At Grain | 1 | 061902.0 | A-061902.0 |
| 22 | At Corn | 1 | 062043.0 | A-062043.0 |
| 23 | Straw Chopper | 2 | 061872.0 | A-061872.0 |
| 27 | At N = 650 - 1550 Min-1 | 1 | 603015.1 | A-603015.1 |
| 27 | At N = 500 - 1400 Min-1 | 1 | 644177.0 | A-644177.0 |
| 27 | At N = 650 - 1500 Min-1 | 1 | 628630.0 | A-628630.0 |
| 28 | For Hph - Chopper | 1 | 629410.0 | A-629410.0 |
| 29 | For Hph - Chopper | 1 | 680334.1 | A-680334.1 |
| 30 | Perkins 6.3544 | 2 | 147228.1 | A-147228.1 |
| 30 | Perkins 1006.6 | 1 | 147233.1 | A-147233.1 |
| 30 | Mercedes Om 352 | 1 | 133523.0 | A-133523.0 |

CLAAS DOMINATOR 76



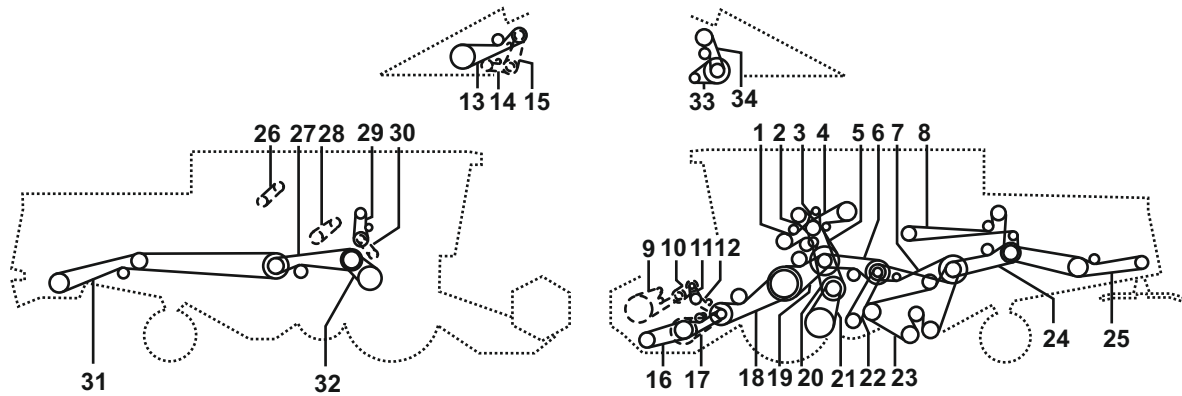

| Belt No. |  | No. of Belts | OEM  Part No. | PIX  Part No. |
|----------|---|--------------|--|--|
| 1 | - | 1 | 673625.0 | A-673625.0 |
| 2 | Hydraulic Pump Drive | 1 | 767057.1 | A-767057.1 |
| 3 | - | 1 | 621903.0 | A-621903.0 |
| 4 | Discharge Auger Shaft | 1 | 673614.0 | A-673614.0 |
| 5 | Traction Drive | 1 | 671012.0 | A-671012.0 |
| 6 | - | 1 | 603337.0 | A-603337.0 |
| 6 | Fan Drive | 1 | 672358.0 | A-672358.0 |
| 7 | Sieve Drive | 1 | 672359.0 | A-672359.0 |
| 7 | - | 1 | 603336.0 | A-603336.0 |
| 8 | Elevator Drive Unit | 1 | 629732.1 | A-629732.1 |
| 9 | - | 1 | 603284.0 | A-603284.0 |
| 10 | - | 1 | 056961.0 | A-056961.0 |
| 11 | Reel Drive Variable Speed | 1 | 670224.0 | A-670224.0 |
| 12 | - | 1 | 056961.0 | A-056961.0 |
| 16 | - | 1 | 603283.0 | A-603283.0 |
| 17 | - | 1 | 603048.0 | A-603048.0 |
| 18 | - | 1 | 603122.0 | A-603122.0 |
| 20 | Knife Drive | 1 | 629214.0 | A-629214.0 |
| 21 | - | 1 | 673638.1 | A-673638.1 |
| 22 | - | 1 | 629436.0 | A-629436.0 |
| 23 | - | 1 | 629737.0 | A-629737.0 |
| 24 | - | 1 | 671209.0 | A-671209.0 |
| 25 | - | 2 | 603017.3 | A-603017.3 |
| 26 | - | 1 | 506671.1 | A-506671.1 |
| 27 | - | 1 | 623427.1 | A-623427.1 |
| 31 | - | 1 | 783430.1 | A-783430.1 |
| 32 | - | 1 | 603247.0 | A-603247.0 |
| 33 | - | 1 | 061360.0 | A-061360.0 |
| 34 | - | 1 | 060306.2 | A-060306.2 |
| 35 | - | 1 | 603015.1 | A-603015.1 |
| 36 | - | 1 | 629410.0 | A-629410.0 |
| 37 | - | 1 | 680334.1 | A-680334.1 |





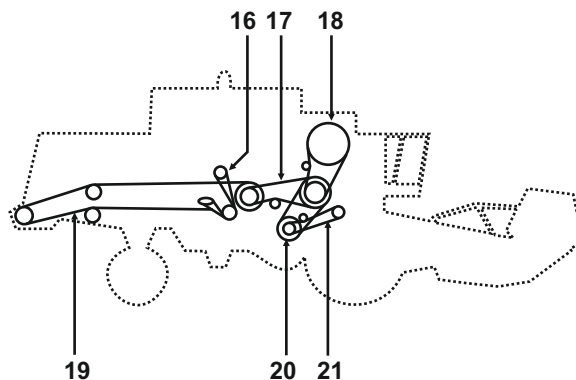
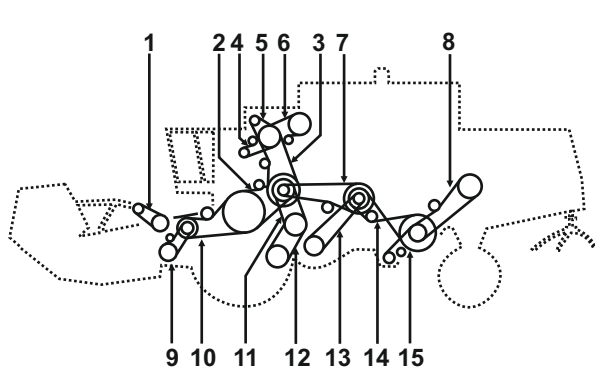

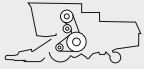
| Belt No. |  | No. of Belts | OEM  Part No. | PIX  Part No. |
|----------|---|--------------|--|--|
| 1 | At Hydraulic Ground Drive | 1 | 673625.0 | A-673625.0 |
| 2 | Hydraulic Pump | 1 | 767057.1 | A-767057.1 |
| 3 | At Air Conditioning | 1 | 629908.1 | A-629908.1 |
| 4 | - | 1 | 673614.1 | A-673614.1 |
| 5 | - | 1 | 671012.1 | A-671012.1 |
| 6 | - | 1 | 603337.0 | A-603337.0 |
| 7 | - | 1 | 603336.1 | A-603336.1 |
| 8 | - | 1 | 629732.2 | A-629732.2 |
| 11 | For Cutterbar | 1 | 670224.1 | A-670224.1 |
| 13 | For Corn Picker | 1 | 692149.0 | A-692149.0 |
| 13 | For Corn Picker | 1 | 692150.0 | A-692150.0 |
| 16 | At 3.0 M Cutterbar | 2 | 778717.1 | A-778717.1 |
| 16 | From 3.6m Cutterbar | 1 | 713506.2 | A-713506.2 |
| 18 | From No. 09101947 For Corn | 1 | 603290.0 | A-603290.0 |
| 18 | Feeder Drive To No. 09101946 For Corn | 2 | 629836.0 | A-629836.0 |
| 18 | From No. 09101947 For Corn | 2 | 603290.0 | A-603290.0 |
| 18 | Feeder Drive To No. 09101946 For Corn | 2 | 629836.0 | A-629836.0 |
| 19 | - | 1 | 673638.1 | A-673638.1 |
| 20 | At Mechanical Ground Drive | 1 | 603427.0 | A-603427.0 |
| 21 | At Mechanical Ground Drive | 1 | 603317.0 | A-603317.0 |
| 22 | - | 1 | 671209.0 | A-671209.0 |
| 23 | Returns Auger | 2 | 603017.3 | A-603017.3 |
| 24 | - | 1 | 506671.2 | A-506671.2 |
| 25 | For Straw Spreader | 1 | 623427.1 | A-623427.1 |
| 27 | For Straw Chopper | 1 | 060306.3 | A-060306.3 |
| 29 | Rotary Screen | 1 | 603341.0 | A-603341.0 |
| 31 | For Grain - Chopper | 1 | 061360.0 | A-061360.0 |
| 31 | For Corn Chopper | 1 | 061214.0 | A-061214.0 |
| 32 | At N = 650 - 1500 Min-1 | 1 | 628630.0 | A-628630.0 |
| 32 | At N = 500 - 1400 Min-1 | 1 | 644177.0 | A-644177.0 |
| 32 | At Chain Drive Claas | 1 | 603132.1 | A-603132.1 |
| 34 | For Hpg - G Chopper | 1 | 680334.1 | A-680334.1 |

CLAAS DOMINATOR 80 - 85

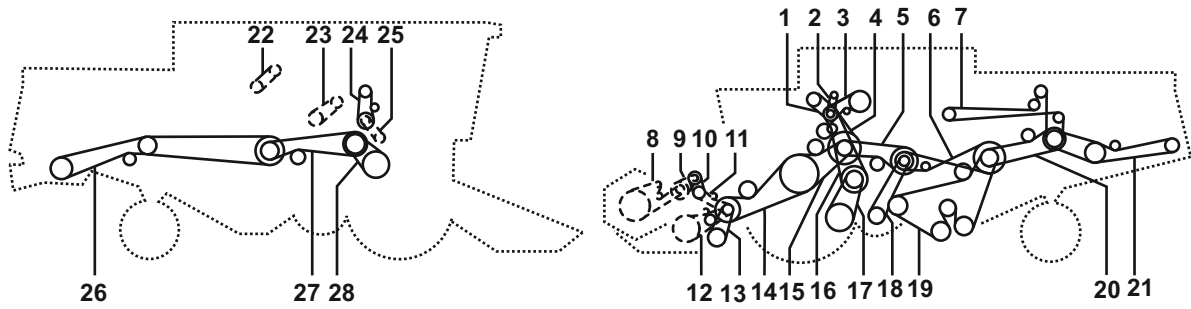





| Belt No. |  | No. of Belts | OEM  Part No. | PIX  Part No. |
|----------|---|--------------|--|--|
| 1 | | 1 | 670224.0 | A-670224.0 |
| 2 | | 1 | 560562.0 | A-560562.0 |
| 3 | | 1 | 671012.0 | A-671012.0 |
| 4 | | 1 | 673625.0 | A-673625.0 |
| 5 | | 1 | 767057.0 | A-767057.0 |
| 5 | | 1 | 532011.0 | A-532011.0 |
| 5 | | 1 | 633030.0 | A-633030.0 |
| 5 | | 1 | 656028.0 | A-656028.0 |
| 6 | | 1 | 673614.0 | A-673614.0 |
| 7 | | 1 | 672358.0 | A-672358.0 |
| 8 | | 1 | 629036.0 | A-629036.0 |
| 8 | | 1 | 673601.0 | A-673601.0 |
| 9 | | 1 | 769202.0 | A-769202.0 |
| 9 | | 1 | 629214.0 | A-629214.0 |
| 10 | | 1 | 778717.0 | A-778717.0 |
| 10 | | 1 | 673639.0 | A-673639.0 |
| 11 | | 1 | 720866.0 | A-720866.0 |
| 12 | | 1 | 671083.0 | A-671083.0 |
| 13 | | 1 | 671209.0 | A-671209.0 |
| 14 | | 1 | 672359.0 | A-672359.0 |
| 15 | | 1 | 673690.0 | A-673690.0 |
| 16 | | 1 | 501925.0 | A-501925.0 |
| 17 | | 1 | 060306.0 | A-060306.0 |
| 18 | | 1 | 802931.0 | A-802931.0 |
| 19 | | 1 | 060949.0 | A-060949.0 |
| 20 | | 1 | 671015.0 | A-671015.0 |
| 20 | | 1 | 629035.0 | A-629035.0 |
| 21 | | 1 | 671012.0 | A-671012.0 |
| 21 | | 1 | 629510.0 | A-629510.0 |

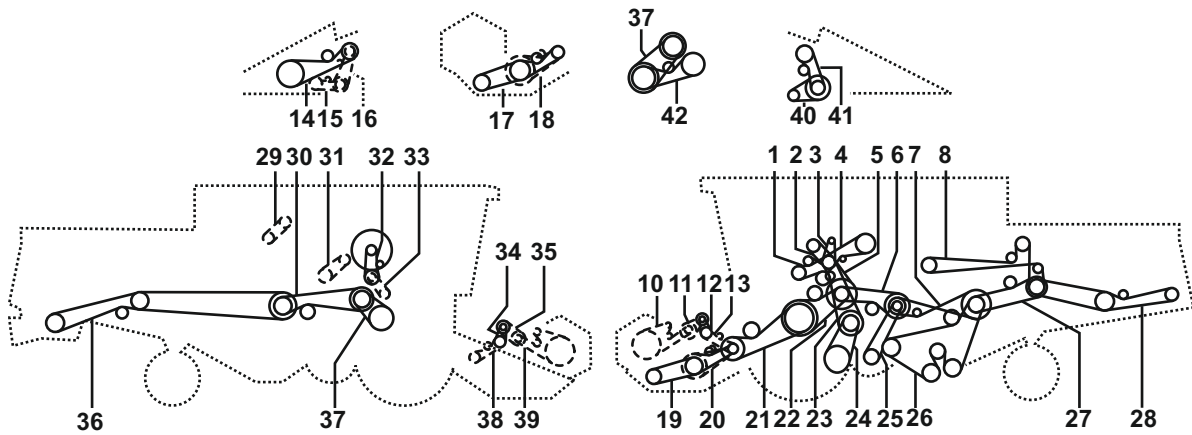

| Belt No. |  | No. of Belts | OEM  Part No. | PIX  Part No. |
|----------|---|--------------|--|--|
| 1 | Hydraulic Pump Drive | 1 | 767057.0 | A-767057.0 |
| 2 | - | 1 | 621903.0 | A-621903.0 |
| 3 | Discharge Auger Shaft | 1 | 673614.0 | A-673614.0 |
| 4 | Traction Drive | 1 | 671012.0 | A-671012.0 |
| 5 | - | 1 | 603337.0 | A-603337.0 |
| 6 | - | 1 | 603336.0 | A-603336.0 |
| 7 | Elevator Drive Unit | 1 | 629732.0 | A-629732.0 |
| 10 | Reel Drive Elevator | 1 | 670224.0 | A-670224.0 |
| 13 | Knife Drive | 1 | 629214.0 | A-629214.0 |
| 14 | - | 1 | 603122.0 | A-603122.0 |
| 15 | - | 1 | 673638.0 | A-673638.0 |
| 16 | - | 1 | 603427.0 | A-603427.0 |
| 17 | - | 1 | 603317.0 | A-603317.0 |
| 18 | - | 1 | 671209.0 | A-671209.0 |
| 19 | - | 2 | 603017.0 | A-603017.0 |
| 20 | - | 1 | 506671.0 | A-506671.0 |
| 21 | - | 1 | 635494.0 | A-635494.0 |
| 24 | - | 1 | 603341.0 | A-603341.0 |
| 26 | - | 1 | 061361.0 | A-061361.0 |
| 27 | Wheel Shaft (front) | 1 | 060306.0 | A-060306.0 |
| 28 | - | 1 | 603015.0 | A-603015.0 |
| 31 | - | 1 | 603247.0 | A-603247.0 |



CLAAS DOMINATOR 88



| Belt No. |  | No. of Belts | OEM  Part No. | PIX  Part No. |
|----------|---|--------------|--|--|
| 1 | - | 1 | 673625.0 | A-673625.0 |
| 2 | Hydraulic Pump | 1 | 767057.1 | A-767057.1 |
| 3 | - | 1 | 629908.1 | A-629908.1 |
| 4 | - | 1 | 673614.1 | A-673614.1 |
| 5 | - | 1 | 671012.1 | A-671012.1 |
| 6 | - | 1 | 603337.0 | A-603337.0 |
| 7 | - | 1 | 603336.1 | A-603336.1 |
| 8 | - | 1 | 629732.2 | A-629732.2 |
| 12 | At 3.6 M - 5.1 M | 1 | 670224.1 | A-670224.1 |
| 14 | For Corn Picker | 1 | 692149.0 | A-692149.0 |
| 14 | For Corn Picker | 1 | 692150.0 | A-692150.0 |
| 17 | At 6.0 M - 6.6 M | 1 | 671013.1 | A-671013.1 |
| 19 | At 3.6 M - 5.1 M | 1 | 713506.2 | A-713506.2 |
| 21 | Shafts Distance 1306 Mm | 2 | 603290.0 | A-603290.0 |
| 21 | Feeder Drive Shafts Distance 1177 Mm | 2 | 629836.0 | A-629836.0 |
| 22 | - | 1 | 673638.1 | A-673638.1 |
| 23 | - | 1 | 609822.0 | A-609822.0 |
| 24 | - | 1 | 609823.0 | A-609823.0 |
| 25 | - | 1 | 671209.0 | A-671209.0 |
| 26 | - | 2 | 603017.3 | A-603017.3 |
| 27 | - | 1 | 506671.2 | A-506671.2 |
| 28 | - | 1 | 635494.0 | A-635494.0 |
| 30 | - | 1 | 060306.3 | A-060306.3 |
| 32 | Rotary Screen | 1 | 603341.0 | A-603341.0 |
| 34 | At 6.0 M - 6.6 M | 1 | 670224.1 | A-670224.1 |
| 36 | For Grain - Chopper | 1 | 061361.0 | A-061361.0 |
| 36 | For Corn - Chopper | 1 | 061213.0 | A-061213.0 |
| 37 | At Var. 7715 | 1 | 609823.0 | A-609823.0 |
| 37 | At N = 650 - 1500 Min-1 | 1 | 628630.0 | A-628630.0 |
| 37 | At N = 500 - 1400 Min-1 | 1 | 644177.0 | A-644177.0 |
| 41 | For Hph-g Chopper | 1 | 680334.1 | A-680334.1 |
| 42 | At Var. 7715 | 1 | 661220.1 | A-661220.1 |

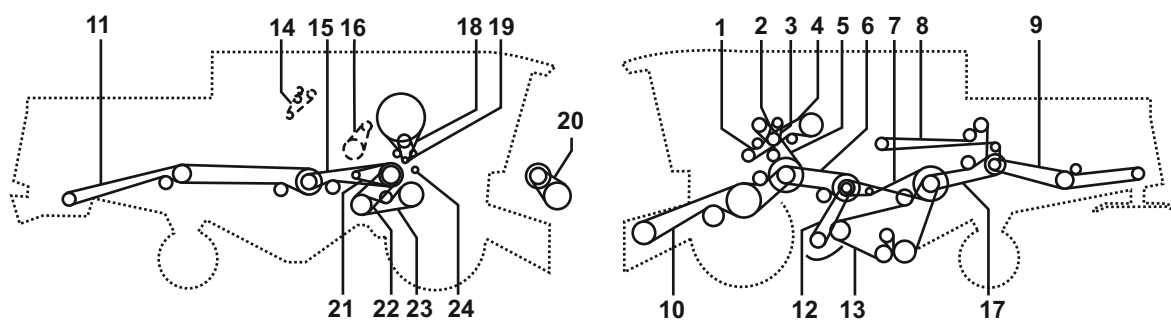

CLAAS DOMINATOR 88 VX





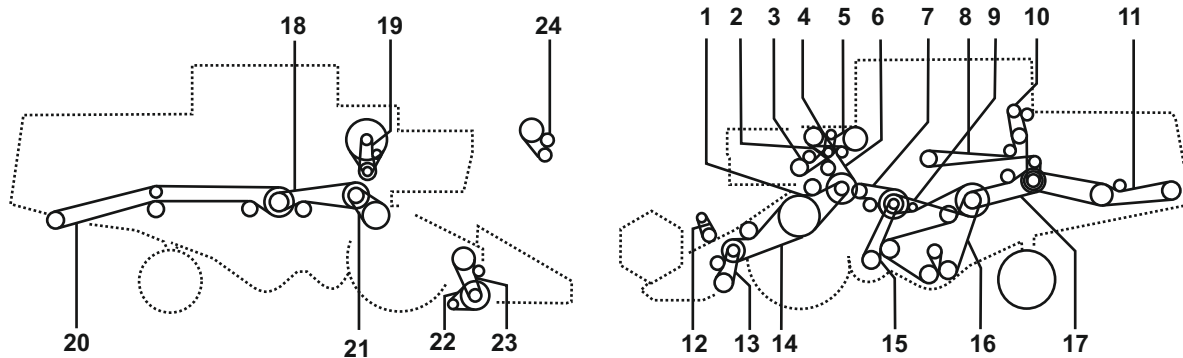

| Belt No. |  | No. of Belts | OEM  Part No. | PIX  Part No. |
|----------|---|--------------|--|--|
| 1 | - | 1 | 544048.0 | A-544048.0 |
| 2 | - | 1 | 767057.1 | A-767057.1 |
| 3 | - | 1 | 629908.1 | A-629908.1 |
| 4 | - | 1 | 629769.1 | A-629769.1 |
| 5 | - | 1 | 671012.1 | A-671012.1 |
| 6 | - | 1 | 603337.0 | A-603337.0 |
| 7 | - | 1 | 603336.1 | A-603336.1 |
| 8 | - | 1 | 644447.0 | A-644447.0 |
| 9 | - | 1 | 635494.0 | A-635494.0 |
| 10 | - | 2 | 661301.0 | A-661301.0 |
| 11 | For Corn | 1 | 061213.0 | A-061213.0 |
| 11 | - | 1 | 061361.0 | A-061361.0 |
| 12 | - | 1 | 671209.0 | A-671209.0 |
| 13 | - | 2 | 603017.3 | A-603017.3 |
| 15 | - | 1 | 060306.3 | A-060306.3 |
| 17 | - | 1 | 506671.2 | A-506671.2 |
| 18 | - | 1 | 661345.0 | A-661345.0 |
| 19 | - | 1 | 657793.0 | A-657793.0 |
| 20 | - | 1 | 628630.0 | A-628630.0 |
| 21 | - | 1 | 644448.0 | A-644448.0 |
| 22 | - | 1 | 609823.0 | A-609823.0 |
| 23 | - | 1 | 661220.1 | A-661220.1 |

CLAAS DOMINATOR 96

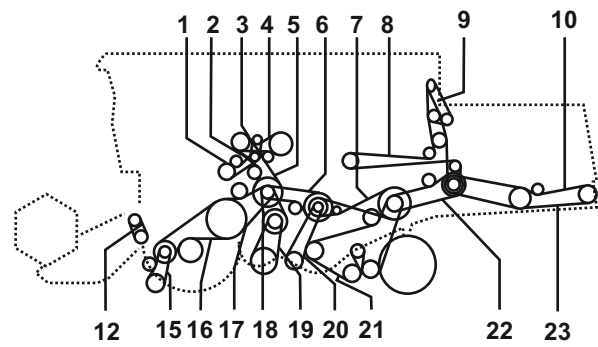
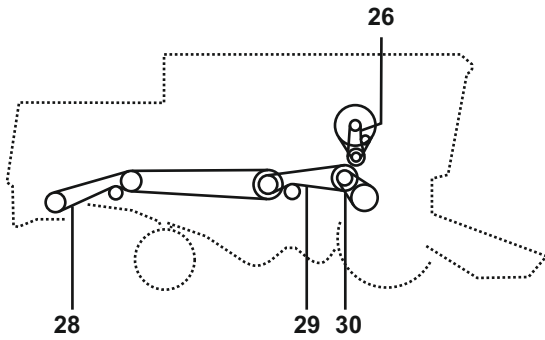



| Belt No. | | No. of Belts | OEM  Part No. | PIX  Part No. |
|----------|---|--------------|--|--|
| 2 | - | 1 | 767057.1 | A-767057.1 |
| 3 | - | 1 | 673625.0 | A-673625.0 |
| 4 | - | 1 | 621903.0 | A-621903.0 |
| 5 | - | 1 | 673614.0 | A-673614.0 |
| 6 | - | 1 | 671012.0 | A-671012.0 |
| 7 | - | 1 | 603337.0 | A-603337.0 |
| 8 | - | 1 | 629732.1 | A-629732.1 |
| 9 | - | 1 | 603336.0 | A-603336.0 |
| 10 | - | 1 | 802931.0 | A-802931.0 |
| 11 | - | 1 | 623427.1 | A-623427.1 |
| 12 | - | 1 | 670224.0 | A-670224.0 |
| 13 | - | 1 | 629214.0 | A-629214.0 |
| 14 | - | 1 | 603122.0 | A-603122.0 |
| 15 | - | 1 | 671209.0 | A-671209.0 |
| 16 | - | 2 | 603017.3 | A-603017.3 |
| 17 | - | 1 | 506671.1 | A-506671.1 |
| 18 | - | 1 | 061306.2 | A-061306.2 |
| 19 | - | 1 | 603341.0 | A-603341.0 |
| 20 | - | 1 | 061360.0 | A-061360.0 |
| 21 | - | 1 | 603015.1 | A-603015.1 |
| 22 | - | 1 | 629410.0 | A-629410.0 |
| 23 | - | 1 | 680334.1 | A-680334.1 |
| 24 | - | 1 | 603247.0 | A-603247.0 |



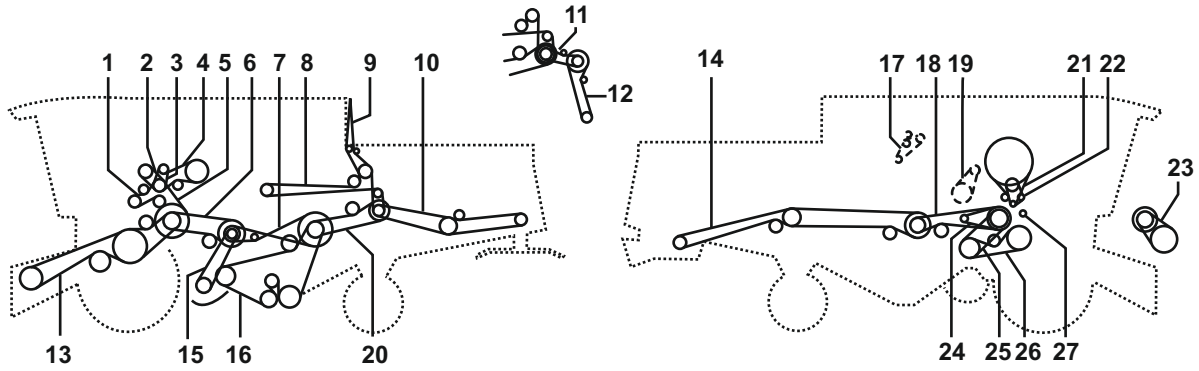

| Belt No. |  | No. of Belts | OEM  Part No. | PIX  Part No. |
|----------|---|--------------|--|--|
| 1 | | 1 | 629001.0 | A-629001.0 |
| 1 | | 1 | 673625.0 | A-673625.0 |
| 2 | | 1 | 603378.0 | A-603378.0 |
| 2 | | 1 | 767057.0 | A-767057.0 |
| 3 | | 1 | 629908.0 | A-629908.0 |
| 4 | | 1 | 673614.0 | A-673614.0 |
| 5 | | 1 | 671012.0 | A-671012.0 |
| 5 | | 1 | 629000.0 | A-629000.0 |
| 6 | | 1 | 603337.0 | A-603337.0 |
| 7 | | 1 | 603336.0 | A-603336.0 |
| 8 | | 1 | 629732.0 | A-629732.0 |
| 9 | | 1 | 802931.0 | A-802931.0 |
| 12 | | 1 | 670224.0 | A-670224.0 |
| 15 | | 1 | 713506.0 | A-713506.0 |
| 16 | | 2 | 629836.0 | A-629836.0 |
| 16 | | 2 | 061872.0 | A-061872.0 |
| 17 | | 1 | 673638.0 | A-673638.0 |
| 18 | | 1 | 609822.0 | A-609822.0 |
| 19 | | 1 | 609823.0 | A-609823.0 |
| 20 | | 1 | 671209.0 | A-671209.0 |
| 21 | | 2 | 603017.0 | A-603017.0 |
| 22 | | 1 | 506671.0 | A-506671.0 |
| 23 | | 1 | 623427.0 | A-623427.0 |
| 26 | | 1 | 603341.0 | A-603341.0 |
| 28 | | 1 | 061214.0 | A-061214.0 |
| 28 | | 1 | 061360.0 | A-061360.0 |
| 29 | | 1 | 060306.0 | A-060306.0 |
| 30 | | 1 | 628630.0 | A-628630.0 |
| 30 | | 1 | 644177.0 | A-644177.0 |

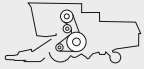
CLAAS DOMINATOR 98 VX

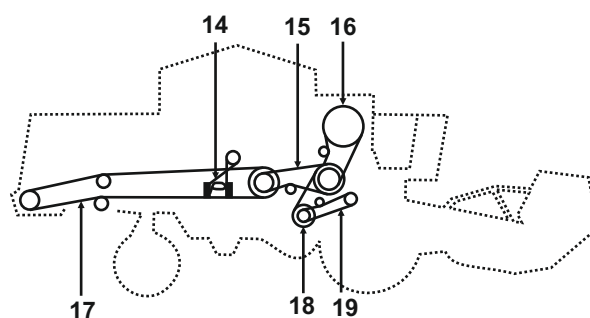
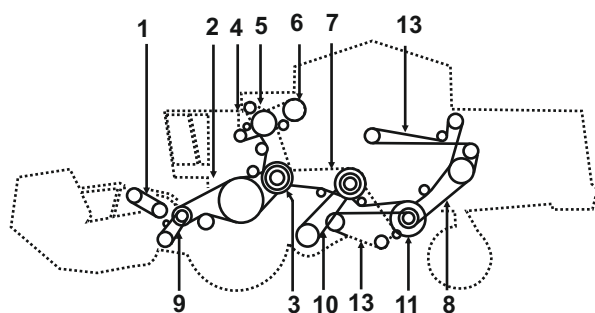

| Belt No. |  | No. of Belts | OEM  Part No. | PIX  Part No. |
|----------|---|--------------|--|--|
| 1 | - | 1 | 544048.0 | A-544048.0 |
| 2 | - | 1 | 767057.1 | A-767057.1 |
| 3 | - | 1 | 629908.1 | A-629908.1 |
| 4 | - | 1 | 629769.1 | A-629769.1 |
| 5 | - | 1 | 661458.0 | A-661458.0 |
| 6 | - | 1 | 603337.0 | A-603337.0 |
| 7 | - | 1 | 603336.1 | A-603336.1 |
| 9 | - | 1 | 802931.0 | A-802931.0 |
| 10 | - | 1 | 623427.1 | A-623427.1 |
| 11 | - | 1 | 755070.1 | A-755070.1 |
| 12 | - | 1 | 785341.0 | A-785341.0 |
| 12 | - | 1 | 066034.0 | A-066034.0 |
| 14 | - | 1 | 061214.0 | A-061214.0 |
| 15 | - | 1 | 671209.0 | A-671209.0 |
| 16 | - | 2 | 603017.3 | A-603017.3 |
| 18 | - | 1 | 060306.3 | A-060306.3 |
| 20 | - | 1 | 506671.2 | A-506671.2 |
| 21 | - | 1 | 661345.0 | A-661345.0 |
| 22 | - | 1 | 657793.0 | A-657793.0 |
| 23 | - | 1 | 644418.0 | A-644418.0 |
| 24 | - | 1 | 644448.0 | A-644448.0 |
| 25 | - | 1 | 609823.0 | A-609823.0 |
| 26 | - | 1 | 661220.1 | A-661220.1 |

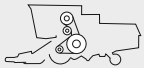

| Belt No. |  | No. of Belts | OEM  Part No. | PIX  Part No. |
|----------|---|--------------|--|--|
| 1 | | 1 | 670224.0 | A-670224.0 |
| 2 | | 2 | 672353.0 | A-672353.0 |
| 3 | | 1 | 629000.0 | A-629000.0 |
| 4 | | 1 | 629001.0 | A-629001.0 |
| 5 | | 1 | 629002.0 | A-629002.0 |
| 6 | | 1 | 673614.0 | A-673614.0 |
| 7 | | 1 | 672358.0 | A-672358.0 |
| 8 | | 1 | 629036.0 | A-629036.0 |
| 9 | | 1 | 769202.0 | A-769202.0 |
| 9 | | 1 | 629214.0 | A-629214.0 |
| 10 | | 1 | 671209.0 | A-671209.0 |
| 11 | | 1 | 672359.0 | A-672359.0 |
| 12 | | 1 | 629081.0 | A-629081.0 |
| 13 | | 1 | 629732.0 | A-629732.0 |
| 14 | | 1 | 501925.0 | A-501925.0 |
| 15 | | 1 | 060306.0 | A-060306.0 |
| 16 | | 1 | 802931.0 | A-802931.0 |
| 17 | | 1 | 061253.0 | A-061253.0 |
| 18 | | 1 | 629035.0 | A-629035.0 |
| 19 | | 1 | 629510.0 | A-629510.0 |

CLAAS DOMINATOR 106

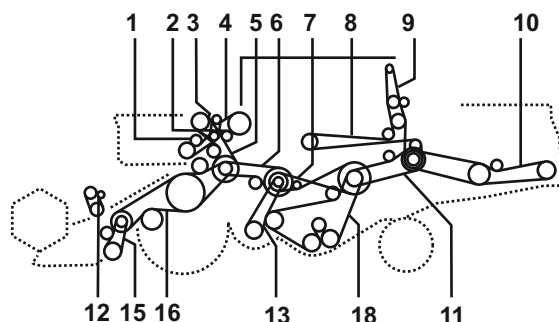
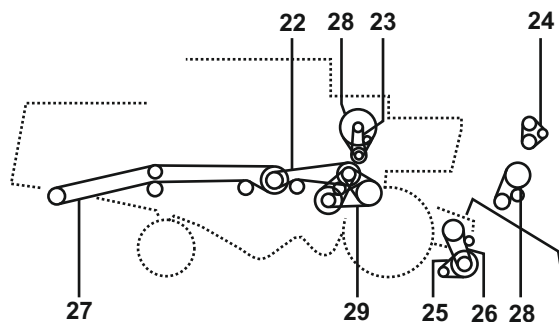



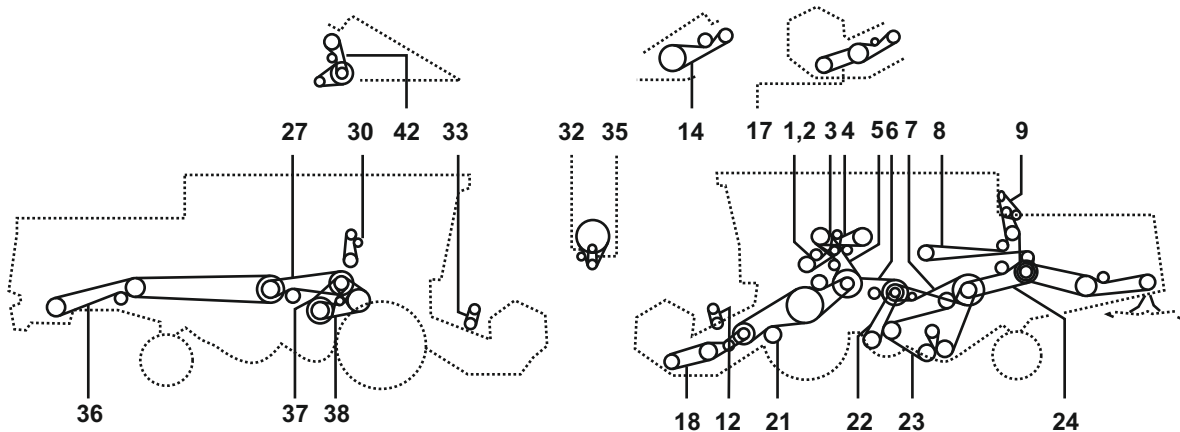

| Belt No. |  | No. of Belts | OEM  Part No. | PIX  Part No. |
|----------|---|--------------|--|--|
| 1 | Hydraulic Pump Drive (om 360) | 1 | 629001.0 | A-629001.0 |
| 1 | Main (om 401) | 1 | 629279.0 | A-629279.0 |
| 2 | Om 360 | 1 | 603378.0 | A-603378.0 |
| 2 | Om 401 | 1 | 689175.0 | A-689175.0 |
| 3 | - | 1 | 621903.0 | A-621903.0 |
| 4 | Grain Tank (om 360) | 1 | 673614.0 | A-673614.0 |
| 4 | Grain Tank (om 401) | 1 | 672351.0 | A-672351.0 |
| 5 | Main/drum | 1 | 629000.0 | A-629000.0 |
| 6 | - | 1 | 603337.0 | A-603337.0 |
| 7 | Return Auger Drive | 1 | 603336.0 | A-603336.0 |
| 8 | Elevator Drive Unit | 1 | 629732.1 | A-629732.1 |
| 9 | - | 1 | 640653.0 | A-640653.0 |
| 10 | - | 1 | 623427.1 | A-623427.1 |
| 11 | Straw Walker Drive | 1 | 506671.1 | A-506671.1 |
| 12 | Reel Drive Variable Speed | 1 | 670224.0 | A-670224.0 |
| 13 | - | 1 | 603380.0 | A-603380.0 |
| 15 | Knife Drive | 1 | 629214.0 | A-629214.0 |
| 16 | Table Drive | 2 | 629441.0 | A-629441.0 |
| 18 | Sieve Pan (from Nr. 9000439) | 1 | 609762.0 | A-609762.0 |
| 18 | Sieve Pan (to Nr. 9000438) | 1 | 603033.0 | A-603033.0 |
| 22 | Countershaft Drive | 1 | 060306.2 | A-060306.2 |
| 23 | - | 1 | 603341.0 | A-603341.0 |
| 24 | Engine (om 401) | 1 | 133528.0 | A-133528.0 |
| 24 | Engine (om 401) | 2 | 133549.0 | A-133549.0 |
| 24 | Engine (om 360) | 1 | 685693.0 | A-685693.0 |
| 25 | - | 1 | 629410.0 | A-629410.0 |
| 26 | - | 1 | 680334.1 | A-680334.1 |
| 27 | Straw Chopper Drive | 1 | 061360.0 | A-061360.0 |
| 28 | Drum Drive | 1 | 629366.1 | A-629366.1 |
| 28 | Drum Drive | 1 | 629035.0 | A-629035.0 |
| 29 | Cylinder | 1 | 603354.0 | A-603354.0 |

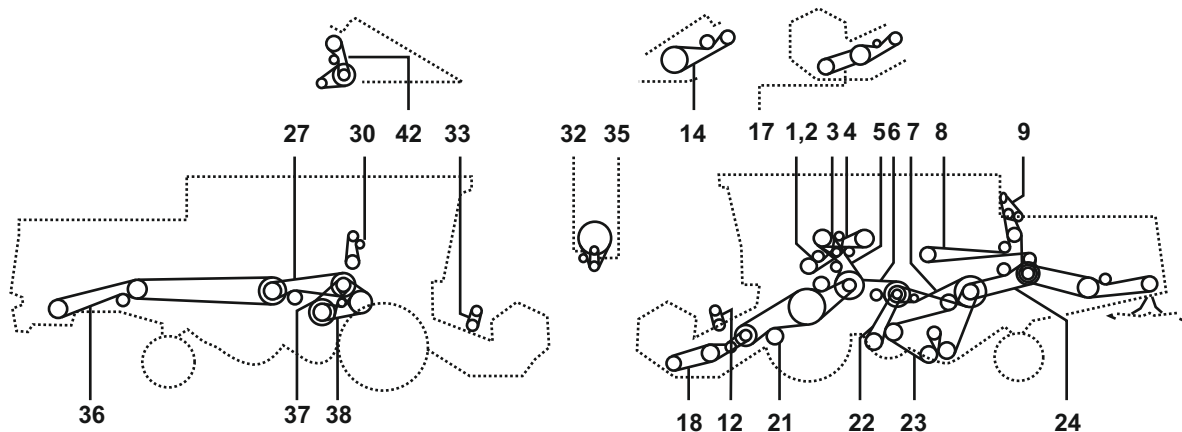

| Belt No. |  | No. of Belts | OEM  Part No. | PIX  Part No. |
|----------|---|--------------|--|--|
| 1 | For Mercedes Engine Om 421 | 1 | 629279.0 | A-629279.0 |
| 1 | For Mercedes Engine Om 366 La | 1 | 644405.1 | A-644405.1 |
| 1 | For Mercedes Engine Om 441 A | 1 | 661092.1 | A-661092.1 |
| 2 | - | 1 | 689175.0 | A-689175.0 |
| 3 | - | 1 | 629908.0 | A-629908.0 |
| 3 | For Var. 7705 | 1 | 661114.0 | A-661114.0 |
| 4 | For Var. 7605 | 1 | 660409.0 | A-660409.0 |
| 4 | For Var. 7705 | 1 | 661093.0 | A-661093.0 |
| 4 | To Nr. 09403057 | 1 | 629763.0 | A-629763.0 |
| 5 | To Nr. 09403057 | 1 | 629000.0 | A-629000.0 |
| 5 | From Nr. 09403058 | 1 | 644404.1 | A-644404.1 |
| 6 | - | 1 | 603337.0 | A-603337.0 |
| 7 | - | 1 | 603336.0 | A-603336.0 |
| 8 | To Nr. 09404032 | 1 | 629732.0 | A-629732.0 |
| 8 | From Nr. 09404033 | 1 | 644447.0 | A-644447.0 |
| 9 | Not Serie Ma | 1 | 640653.0 | A-640653.0 |
| 12 | For 3.9 M - 5.1 M | 1 | 670224.0 | A-670224.0 |
| 14 | For Maize Picker | 1 | 692149.0 | A-692149.0 |
| 14 | For Maize Picker | 1 | 692150.0 | A-692150.0 |
| 17 | For 6.0 M - 9.0 M | 1 | 671013.0 | A-671013.0 |
| 19 | Straw Walker Drive | 1 | 713506.0 | A-713506.0 |
| 21 | Shaft Base 1177 Mm | 2 | 629441.0 | A-629441.0 |
| 21 | Shaft 1463 Mm (to Nr. 09404032) | 2 | 603017.0 | A-603017.0 |
| 21 | Shaft 1306 Mm (to Nr. 09404032) | 1 | 603430.0 | A-603430.0 |
| 21 | Shaft 1306 Mm (from Nr. 09404033) | 1 | 644419.0 | A-644419.0 |
| 21 | Shaft 1463 Mm (from Nr. 0940433) | 2 | 661301.0 | A-661301.0 |
| 22 | Countershaft Drive | 1 | 603380.0 | A-603380.0 |
| 23 | - | 1 | 609762.0 | A-609762.0 |
| 24 | - | 1 | 506671.0 | A-506671.0 |
| 25 | - | 1 | 623427.0 | A-623427.0 |
| 27 | Straw Chopper Drive | 1 | 060306.0 | A-060306.0 |
| 30 | - | 1 | 603341.0 | A-603341.0 |
| 30 | - | 1 | 783430.1 | A-783430.1 |
| 32 | From Nr. 09405335 | 1 | 661345.0 | A-661345.0 |
| 32 | For Raba - Engine | 1 | 783876.0 | A-783876.0 |
| 32 | To Nr. 09405334 | 1 | 821734.2 | A-821734.2 |

CLAAS DOMINATOR108 - 118 HYDR





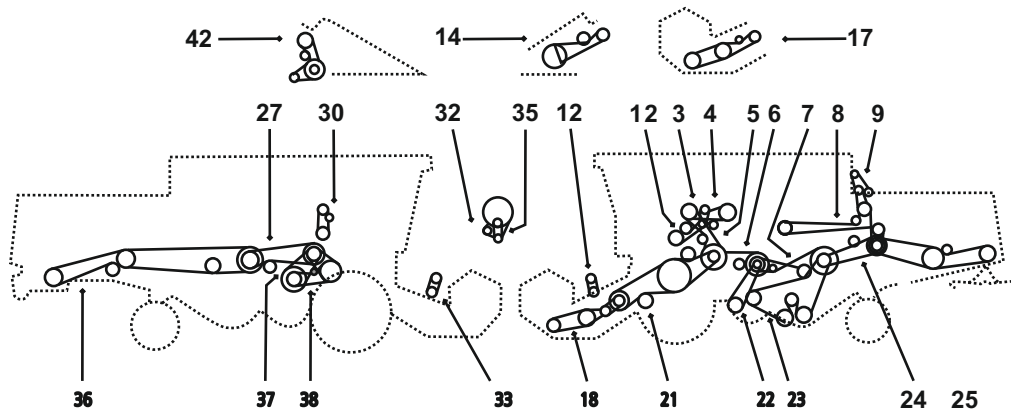

| Belt No. |  | No. of Belts | OEM  Part No. | PIX  Part No. |
|----------|---|--------------|--|--|
| 33 | For 6.0 M - 9.0 M | 1 | 670224.0 | A-670224.0 |
| 35 | For Raba - Engine | 1 | 629764.0 | A-629764.0 |
| 35 | For Om 366 La | 1 | 657793.0 | A-657793.0 |
| 35 | For Om 366 La | 1 | 661244.0 | A-661244.0 |
| 35 | For Mercedes Engine Om 441 A | 1 | 661245.0 | A-661245.0 |
| 36 | Chopper Drive (maize) | 1 | 061214.0 | A-061214.0 |
| 36 | Chopper Drive (grain) (from Nr. 09403058) | 1 | 061353.0 | A-061353.0 |
| 36 | Chopper Drive (grain) (to Nr. 09403057) | 1 | 061360.0 | A-061360.0 |
| 37 | From Nr. 09403058 | 1 | 609823.0 | A-609823.0 |
| 37 | To Nr. 09403057 | 1 | 629035.0 | A-629035.0 |
| 38 | Var. 7818 | 1 | 661298.0 | A-661298.0 |
| 38 | For N=510-1220 Rpm | 1 | 629510.1 | A-629510.1 |
| 38 | For N=650-1500 Rpm | 1 | 603354.0 | A-603354.0 |
| 38 | Var. 7693 / Var. 7716 | 1 | 661220.0 | A-661220.0 |
| 42 | - | 1 | 680334.0 | A-680334.0 |
| 43 | For Air Exhaust | 1 | 644448.0 | A-644448.0 |

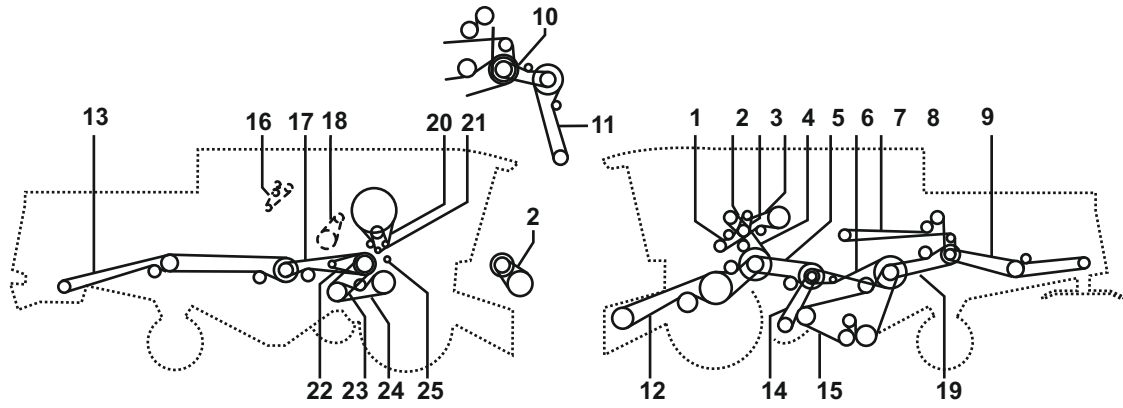

| Belt No. |  | No. of Belts | OEM  Part No. | PIX  Part No. |
|----------|---|--------------|--|--|
| 1 | - | 1 | 689175.0 | A-689175.0 |
| 2 | - | 1 | 629908.0 | A-629908.0 |
| 3 | - | 1 | 629769.0 | A-629769.0 |
| 4 | Main/drum | 1 | 629000.0 | A-629000.0 |
| 5 | - | 1 | 603337.0 | A-603337.0 |
| 6 | Return Auger Drive | 1 | 603336.0 | A-603336.0 |
| 7 | Elevator Drive Unit | 1 | 629732.0 | A-629732.0 |
| 7 | From Nr. 09404033 | 1 | 644447.0 | A-644447.0 |
| 8 | - | 1 | 640653.0 | A-640653.0 |
| 11 | For 3.9 M - 5.1 M | 1 | 670224.0 | A-670224.0 |
| 13 | For Maize Picker | 1 | 692149.0 | A-692149.0 |
| 13 | For Maize Picker | 1 | 692150.0 | A-692150.0 |
| 16 | For 6.0 M - 9.0 M | 1 | 671013.0 | A-671013.0 |
| 18 | For 3.9 M - 5.1 M | 1 | 713506.0 | A-713506.0 |
| 20 | Shaft Base 1177 Mm | 2 | 629836.0 | A-629836.0 |
| 20 | Shaft 1306 Mm | 1 | 603290.0 | A-603290.0 |
| 21 | Table Clutch | 1 | 673638.0 | A-673638.0 |
| 22 | - | 1 | 609822.0 | A-609822.0 |
| 23 | - | 1 | 609823.0 | A-609823.0 |
| 24 | - | 1 | 603380.0 | A-603380.0 |
| 25 | - | 1 | 609762.0 | A-609762.0 |
| 26 | - | 1 | 506671.0 | A-506671.0 |
| 27 | - | 1 | 623427.0 | A-623427.0 |
| 29 | Countershaft Drive | 1 | 060306.0 | A-060306.0 |
| 32 | To Nr. 09400750 | 1 | 603341.0 | A-603341.0 |
| 32 | From Nr. 09400751 | 1 | 783430.1 | A-783430.1 |
| 34 | For 6.0 M - 9.0 M | 1 | 670224.0 | A-670224.0 |
| 36 | Chopper Drive (maize) | 1 | 061214.0 | A-061214.0 |
| 36 | Chopper Drive (grain) (from Nr. 09403058) | 1 | 061353.0 | A-061353.0 |
| 36 | Chopper Drive (grain) (to Nr. 09403057) | 1 | 061360.0 | A-061360.0 |
| 37 | - | 1 | 628630.0 | A-628630.0 |
| 41 | - | 1 | 680334.0 | A-680334.0 |
| 42 | For Two-stage Drive | 1 | 661220.0 | A-661220.0 |

CLAAS DOMINATOR 108 VX



| Belt No. |  | No. of Belts | OEM  Part No. | PIX  Part No. |
|----------|---|--------------|--|--|
| 1 | - | 1 | 544049.0 | A-544049.0 |
| 2 | - | 1 | 767057.1 | A-767057.1 |
| 3 | - | 1 | 629908.1 | A-629908.1 |
| 4 | - | 1 | 660409.0 | A-660409.0 |
| 5 | - | 1 | 644404.1 | A-644404.1 |
| 6 | - | 1 | 603337.0 | A-603337.0 |
| 7 | - | 1 | 644141.1 | A-644141.1 |
| 8 | - | 1 | 644447.0 | A-644447.0 |
| 9 | - | 1 | 623427.1 | A-623427.1 |
| 10 | - | 1 | 755070.1 | A-755070.1 |
| 11 | - | 1 | 785341.0 | A-785341.0 |
| 11 | - | 1 | 066034.0 | A-066034.0 |
| 12 | - | 1 | 661337.0 | A-661337.0 |
| 13 | - | 1 | 061214.0 | A-061214.0 |
| 13 | - | 1 | 061353.1 | A-061353.1 |
| 14 | - | 1 | 603380.1 | A-603380.1 |
| 15 | - | 1 | 609762.0 | A-609762.0 |
| 17 | - | 1 | 060306.3 | A-060306.3 |
| 19 | - | 1 | 506671.2 | A-506671.2 |
| 20 | - | 1 | 661345.0 | A-661345.0 |
| 21 | Mercedes Engine Om 366l | 1 | 661244.0 | A-661244.0 |
| 21 | Mercedes Engine Om 441 | 1 | 661245.0 | A-661245.0 |
| 22 | - | 1 | 644448.0 | A-644448.0 |
| 23 | - | 1 | 609823.0 | A-609823.0 |
| 24 | - | 1 | 661298.0 | A-661298.0 |
| 24 | - | 1 | 661220.1 | A-661220.1 |

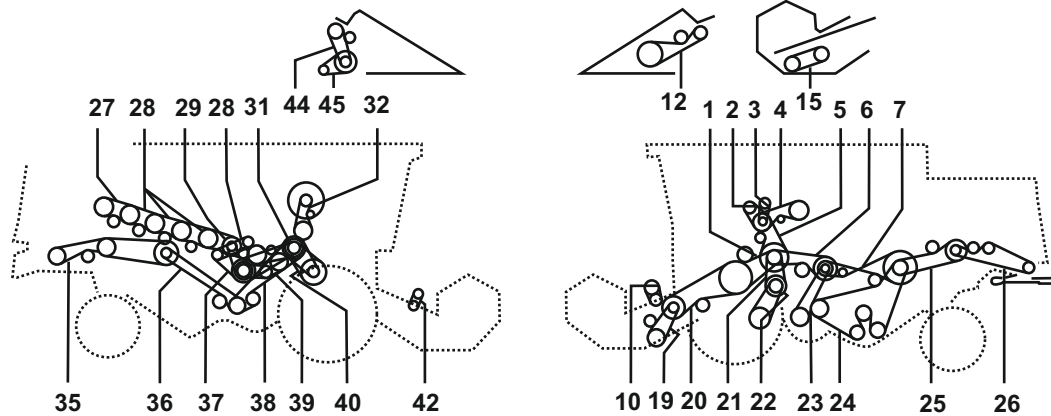

| Belt No. |  | No. of Belts | OEM  Part No. | PIX  Part No. |
|----------|---|--------------|--|--|
| 1 | - | 1 | 673638.1 | A-673638.1 |
| 2 | - | 1 | 689175.0 | A-689175.0 |
| 3 | - | 1 | 629908.1 | A-629908.1 |
| 4 | - | 1 | 629769.0 | A-629769.0 |
| 5 | - | 1 | 629000.0 | A-629000.0 |
| 6 | - | 1 | 603337.0 | A-603337.0 |
| 7 | - | 1 | 644141.0 | A-644141.0 |
| 12 | For Maize Picker | 1 | 692149.0 | A-692149.0 |
| 12 | For Maize Picker | 1 | 692150.0 | A-692150.0 |
| 15 | From 6.0m Cutting Table | 1 | 671013.1 | A-671013.1 |
| 15 | For Soja Cutting Table | 1 | 644209.0 | A-644209.0 |
| 19 | To 5.1 M Cutting Table | 1 | 629214.1 | A-629214.1 |
| 20 | - | 2 | 629836.0 | A-629836.0 |
| 21 | - | 1 | 609822.0 | A-609822.0 |
| 22 | - | 1 | 609823.0 | A-609823.0 |
| 23 | - | 1 | 603380.0 | A-603380.0 |
| 24 | - | 1 | 609762.0 | A-609762.0 |
| 25 | - | 1 | 506671.1 | A-506671.1 |
| 26 | - | 1 | 640653.1 | A-640653.1 |
| 27 | - | 1 | 644014.1 | A-644014.1 |
| 28 | - | 1 | 644015.0 | A-644015.0 |
| 29 | - | 1 | 644016.1 | A-644016.1 |
| 31 | - | 1 | 064168.2 | A-064168.2 |
| 35 | For Maize | 2 | 061872.0 | A-061872.0 |
| 35 | For Grain | 1 | 061701.1 | A-061701.1 |
| 36 | For Straw Chopper | 1 | 061700.0 | A-061700.0 |
| 37 | - | 1 | 603247.1 | A-603247.1 |
| 38 | For Straw Chopper | 1 | 061700.0 | A-061700.0 |
| 39 | - | 1 | 644014.1 | A-644014.1 |
| 40 | Cylinder N=650-1500 Rpm | 1 | 603015.1 | A-603015.1 |
| 40 | Cylinder N=500-1400 Rpm | 1 | 644177.0 | A-644177.0 |
| 42 | From 6.0m Cutting Table | 1 | 670224.0 | A-670224.0 |
| 44 | - | 1 | 680334.1 | A-680334.1 |
| 45 | - | 1 | 629410.0 | A-629410.0 |

CLAAS DOMINATOR 114

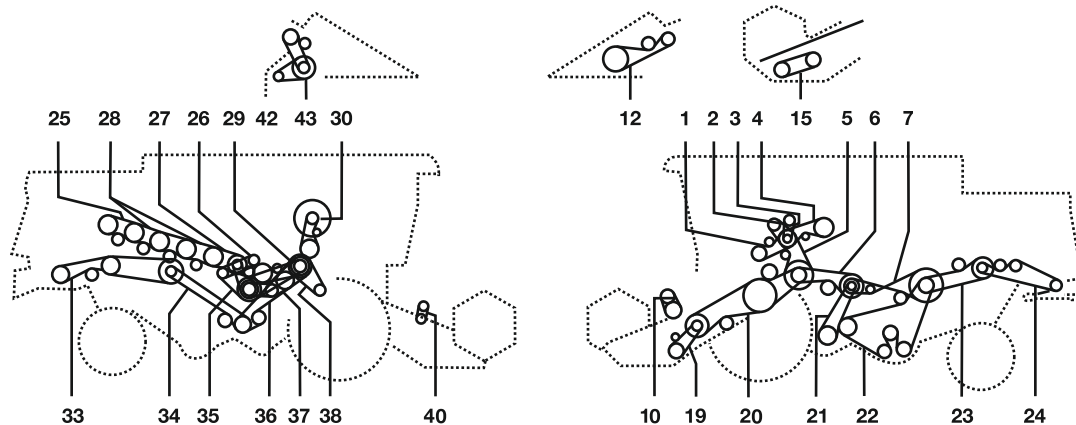

| Belt No. | | No. of Belts | OEM  Part No. | PIX  Part No. |
|----------|--------------------------|--------------|--|--|
| 1 | - | 1 | 629279.0 | A-629279.0 |
| 2 | - | 1 | 629002.1 | A-629002.1 |
| 3 | To Nr. 14200046 | 1 | 621903.1 | A-621903.1 |
| 3 | From Nr. 14200047 | 1 | 629908.1 | A-629908.1 |
| 4 | - | 1 | 629763.0 | A-629763.0 |
| 5 | - | 1 | 629000.0 | A-629000.0 |
| 6 | - | 1 | 603337.0 | A-603337.0 |
| 7 | - | 1 | 644141.0 | A-644141.0 |
| 10 | To 5.7 M Cutting Table | 1 | 670224.0 | A-670224.0 |
| 12 | For Maize Picker | 1 | 692149.0 | A-692149.0 |
| 12 | For Maize Picker | 1 | 692150.0 | A-692150.0 |
| 15 | From 6.0 M Cutting Table | 1 | 671013.1 | A-671013.1 |
| 15 | For Soja Cutting Table | 1 | 644209.0 | A-644209.0 |
| 19 | To 5.7 M Cutting Table | 1 | 629214.1 | A-629214.1 |
| 20 | - | 2 | 603017.3 | A-603017.3 |
| 21 | - | 1 | 603380.0 | A-603380.0 |
| 22 | - | 1 | 609762.0 | A-609762.0 |
| 23 | For Straw Distributor | 1 | 506671.1 | A-506671.1 |
| 24 | For Straw Distributor | 1 | 640653.1 | A-640653.1 |
| 25 | - | 1 | 644014.0 | A-644014.0 |
| 26 | - | 1 | 644015.1 | A-644015.1 |
| 27 | - | 1 | 644016.1 | A-644016.1 |
| 29 | - | 1 | 064168.2 | A-064168.2 |
| 30 | To Nr. 14200176 | 1 | 603341.0 | A-603341.0 |
| 30 | From Nr. 14200177 | 1 | 233843.1 | A-233843.1 |
| 33 | For Maize | 2 | 061872.0 | A-061872.0 |
| 33 | For Grain | 1 | 061701.1 | A-061701.1 |
| 34 | For Straw Chopper | 1 | 061700.0 | A-061700.0 |
| 35 | - | 1 | 603247.1 | A-603247.1 |
| 36 | For Straw Chopper | 1 | 061700.0 | A-061700.0 |
| 37 | - | 1 | 344014.1 | A-344014.1 |
| 38 | Cylinder N=650-1500 Rpm | 1 | 603015.1 | A-603015.1 |
| 38 | Cylinder N=500-1400 Rpm | 1 | 644177.0 | A-644177.0 |
| 40 | From 6.0 M Cutting Table | 1 | 670224.0 | A-670224.0 |
| 42 | - | 1 | 680334.1 | A-680334.1 |
| 43 | - | 1 | 629410.0 | A-629410.0 |

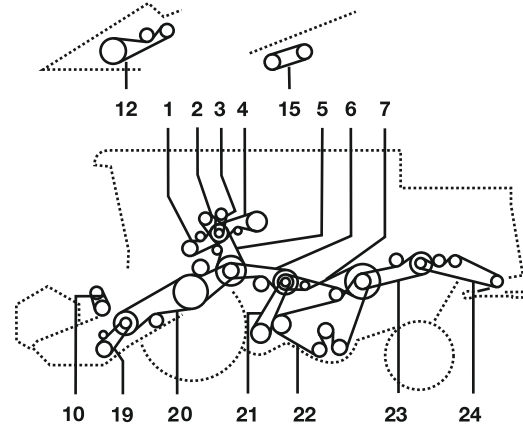
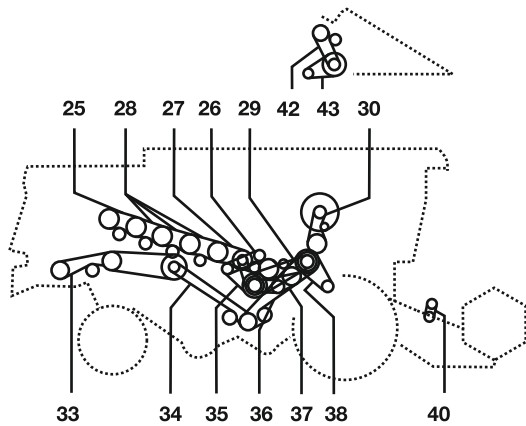

| Belt No. |  | No. of Belts | OEM  Part No. | PIX  Part No. |
|----------|---|--------------|--|--|
| 1 | - | 1 | 629763.0 | A-629763.0 |
| 1 | - | 1 | 644017.0 | A-644017.0 |
| 2 | - | 1 | 629002.1 | A-629002.1 |
| 3 | - | 1 | 629908.1 | A-629908.1 |
| 5 | - | 1 | 644018.0 | A-644018.0 |
| 6 | - | 1 | 603337.0 | A-603337.0 |
| 7 | - | 1 | 644141.0 | A-644141.0 |
| 10 | To 5.1 M Cutting Table | 1 | 670224.0 | A-670224.0 |
| 12 | For Maize Picker | 1 | 692149.0 | A-692149.0 |
| 12 | For Maize Picker | 1 | 692150.0 | A-692150.0 |
| 15 | From 6.0m Cutting Table | 1 | 671013.1 | A-671013.1 |
| 15 | For Soja Cutting Table | 1 | 644209.0 | A-644209.0 |
| 19 | To 5.1 M Cutting Table | 1 | 629214.1 | A-629214.1 |
| 20 | - | 2 | 603017.3 | A-603017.3 |
| 21 | - | 1 | 603380.0 | A-603380.0 |
| 22 | - | 1 | 609762.0 | A-609762.0 |
| 23 | For Straw Distributor | 1 | 506671.1 | A-506671.1 |
| 24 | For Straw Distributor | 1 | 640653.1 | A-640653.1 |
| 25 | - | 1 | 644014.1 | A-644014.1 |
| 26 | - | 1 | 644015.1 | A-644015.1 |
| 27 | - | 1 | 644016.1 | A-644016.1 |
| 29 | - | 1 | 064168.2 | A-064168.2 |
| 30 | - | 1 | 233843.1 | A-233843.1 |
| 33 | For Maize | 2 | 061872.0 | A-061872.0 |
| 33 | For Grain | 1 | 061701.1 | A-061701.1 |
| 34 | For Straw Chopper | 1 | 061700.0 | A-061700.0 |
| 35 | - | 1 | 603247.1 | A-603247.1 |
| 36 | For Straw Chopper | 1 | 061700.0 | A-061700.0 |
| 37 | - | 1 | 644014.1 | A-644014.1 |
| 38 | Cylinder N=650-1500 Rpm | 1 | 603015.1 | A-603015.1 |
| 38 | Cylinder N=500-1400 Rpm | 1 | 644177.0 | A-644177.0 |
| 40 | From 6.0m Cutting Table | 1 | 670224.0 | A-670224.0 |
| 42 | - | 1 | 680334.1 | A-680334.1 |
| 43 | - | 1 | 629410.0 | A-629410.0 |

CLAAS DOMINATOR 116

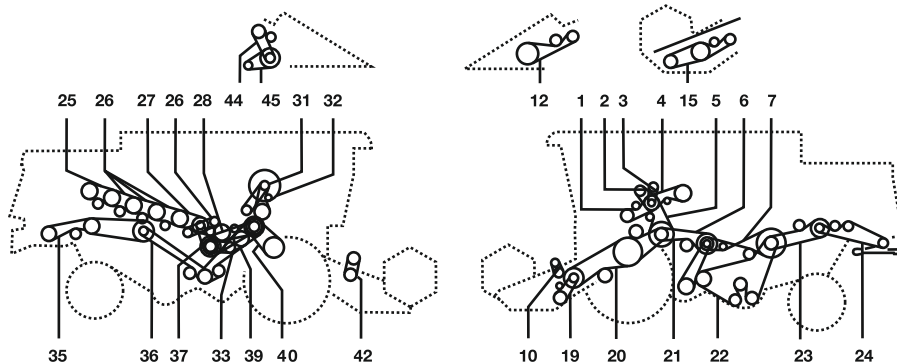



| Belt No. |  | No. of Belts | OEM  Part No. | PIX  Part No. |
|----------|---|--------------|--|--|
| 1 | Hydraulic Pump Drive | 1 | 644017.0 | A-644017.0 |
| 2 | Hydraulic Pump Drive (to Nr. 14400299) | 1 | 689175.0 | A-689175.0 |
| 2 | Hydraulic Pump Drive (from Nr. 14400300) | 1 | 629002.1 | A-629002.1 |
| 3 | To Nr. 14400199 | 1 | 621903.1 | A-621903.1 |
| 3 | From Nr. 14400200 | 1 | 629908.1 | A-629908.1 |
| 4 | Drive Grain Tank | 1 | 629763.0 | A-629763.0 |
| 5 | Main Drive | 1 | 644018.0 | A-644018.0 |
| 6 | - | 1 | 603337.0 | A-603337.0 |
| 7 | Return Auger Drive | 1 | 603336.0 | A-603336.0 |
| 10 | Reel Drive Variable Speed - To 5.7 M Cutting Table | 1 | 670224.0 | A-670224.0 |
| 12 | For Maize Picker | 1 | 692149.0 | A-692149.0 |
| 12 | For Maize Picker | 1 | 692150.0 | A-692150.0 |
| 15 | From 6.0 M Cutting Table | 1 | 671013.1 | A-671013.1 |
| 15 | For Soja Cutting Table | 1 | 644209.0 | A-644209.0 |
| 19 | Knife To 5.7 M Cutting Table | 1 | 629214.1 | A-629214.1 |
| 20 | Table (to Nr. 14400124) | 2 | 629441.0 | A-629441.0 |
| 20 | Table (from Nr. 14400125) | 2 | 603017.3 | A-603017.3 |
| 21 | - | 1 | 603380.0 | A-603380.0 |
| 22 | Sieve Pan Drive | 1 | 609762.0 | A-609762.0 |
| 23 | Straw Walker Drive | 1 | 506671.1 | A-506671.1 |
| 24 | - | 1 | 640653.1 | A-640653.1 |
| 25 | - | 1 | 644014.1 | A-644014.1 |
| 26 | Roller | 1 | 644015.1 | A-644015.1 |
| 27 | Roller | 1 | 644016.1 | A-644016.1 |
| 28 | Intermediate Shaft | 1 | 064168.2 | A-064168.2 |
| 31 | Screen (to Nr. 14400299) | 1 | 233843.1 | A-233843.1 |
| 31 | Screen (from Nr. 14400300) | 1 | 644267.0 | A-644267.0 |
| 32 | From Nr. 14400300 | 1 | 633030.2 | A-633030.2 |
| 35 | For Maize | 2 | 061872.0 | A-061872.0 |
| 35 | For Grain | 1 | 061701.1 | A-061701.1 |
| 36 | For Straw Chopper | 1 | 061700.0 | A-061700.0 |
| 37 | Straw Walker Drive | 1 | 603247.1 | A-603247.1 |
| 38 | For Straw Chopper | 1 | 061700.0 | A-061700.0 |
| 39 | - | 1 | 644014.1 | A-644014.1 |
| 40 | Cylinder N=650-1500 Rpm | 1 | 603015.1 | A-603015.1 |
| 40 | Cylinder N=500-1400 Rpm | 1 | 644177.0 | A-644177.0 |
| 42 | From 6.0 M Cutting Table | 1 | 670224.0 | A-670224.0 |
| 44 | - | 1 | 680334.1 | A-680334.1 |
| 45 | - | 1 | 629410.0 | A-629410.0 |

CLAAS DOMINATOR 118

| Belt No. |  | No. of Belts | OEM  Part No. | PIX  Part No. |
|----------|---|--------------|--|--|
| 1 | At Mercedes Om 441 A | 1 | 661092.1 | A-661092.1 |
| 1 | At Mercedes Om 441 A 163 Kw 4 Groove | 1 | 644405.2 | A-644405.2 |
| 1 | At Mercedes Om 421 | 1 | 629279.0 | A-629279 |
| 2 | At Mercedes Om 441 A | 1 | 633030.2 | A-633030.2 |
| 2 | Hydraulic Pump At Mercedes Om 366 La | 1 | 767057.1 | A-767057.1 |
| 2 | Hydraulic Pump 163 Kw 4 Groove | 1 | 767057.1 | A-767057.1 |
| 2 | - | 1 | 689175.0 | A-689175 |
| 3 | At Mercedes Om 441 A | 1 | 661114.0 | A-661114 |
| 3 | - | 1 | 629908.1 | A-629908.1 |
| 4 | At Mercedes Om 441 A | 1 | 661093.0 | A-661093 |
| 4 | At Mercedes Om 366 La With Hydraulic Ground Drive | 1 | 660409.0 | A-660409 |
| 4 | At Mercedes Om 366 La With Mechanical Ground Drive | 1 | 629769.1 | A-629769.1 |
| 4 | At Mercedes Om 421 | 1 | 629763.0 | A-629763 |
| 4 | At Perkins V8 540 | 1 | 629769.1 | A-629769.1 |
| 4 | At Raba - Motor | 1 | 629763.0 | A-629763 |
| 5 | At 5 - Rill Drive From 09403058 | 1 | 644403.0 | A-644403 |
| 5 | At 4 - Rill Drive From No. 09403058 | 1 | 644404.1 | A-644404.1 |
| 5 | To No. 094030057 | 1 | 629000.1 | A-629000.1 |
| 6 | - | 1 | 603337.0 | A-603337 |
| 7 | - | 1 | 603336.1 | A-603336.1 |
| 8 | From No. 09404033 | 1 | 644447.0 | A-644447 |
| 8 | To No. 09404032 | 1 | 629732.2 | A-629732.2 |
| 9 | Not At Series Maxi | 1 | 640653.1 | A-640653.1 |
| 12 | At 3.9 M - 5.1 M | 1 | 670224.1 | A-670224.1 |
| 14 | For Corn Picker | 1 | 692149.0 | A-692149 |
| 14 | For Corn Picker | 1 | 692150.0 | A-692150 |
| 17 | At 6.0 M - 9.0 M | 1 | 671013.1 | A-671013.1 |
| 19 | At 3.9 M - 5.1 M | 1 | 713506.2 | A-713506.2 |
| 21 | Shafts Distance 1306 Mm From No. 09404033 | 2 | 644419.0 | A-644419 |
| 21 | To No. 09404032 | 2 | 603430.0 | A-603430 |
| 21 | Shafts Distance 1177 Mm | 2 | 629441.0 | A-629441 |
| 21 | Shafts Distance 1463 Mm From No. 09404033 | 2 | 661301.0 | A-661301 |
| 21 | To No. 09404032 | 2 | 603017.3 | A-603017.3 |
| 22 | - | 1 | 603380.1 | A-603380.1 |
| 23 | - | 1 | 609762.0 | A-609762 |
| 24 | - | 1 | 506671.2 | A-506671.2 |
| 25 | - | 1 | 623427.1 | A-623427.1 |
| 27 | - | 1 | 060306.3 | A-060306.3 |
| 30 | At Mercedes - Motor From 09400751 - 09403057 | 1 | 783430.1 | A-783430.1 |
| 30 | Rotary Screen At Mercedes - Motor To No. 09400750 | 1 | 603341.0 | A-603341 |
| 32 | From No. 09405335 | 1 | 661345.0 | A-661345 |
| 32 | To No. 09405334 | 1 | 821734.2 | A-821734.2 |
| 32 | At Raba - Motor | 1 | 783876.0 | A-783876 |
| 33 | At 6.0 M - 9.0 M | 1 | 670224.1 | A-670224.1 |
| 35 | At Om 366 La 163 Kw | 1 | 661244.0 | A-661244 |

CLAAS DOMINATOR 118

| Belt No. |  | No. of Belts | OEM  Part No. | PIX  Part No. |
|----------|---|--------------|--|--|
| 35 | At Mercedes Om 441 A | 1 | 661245.0 | A-661245.0 |
| 35 | At Om 366 La 132 Kw | 1 | 657793.0 | A-657793 |
| 35 | At Raba - Motor | 1 | 629764.0 | A-629764 |
| 36 | For Grain Chopper From No. 09403058 | 1 | 061353.1 | A-061353.1 |
| 36 | For Grain Chopper To No. 09403057 | 1 | 061360.0 | A-061360.0 |
| 36 | For Corn - Chopper | 1 | 061214.0 | A-061214.0 |
| 37 | From No. 09403058 | 1 | 609823.0 | A-609823 |
| 37 | To No. 09403057 | 1 | 629035.0 | A-629035 |
| 38 | Var. 7818 2 Groove | 1 | 661298.0 | A-661298 |
| 38 | Var. 7693 / Var. 7716 3 Groove | 1 | 661220.1 | A-661220.1 |
| 38 | At N = 650 - 1500 Min-1 To 09403057 | 1 | 603354.0 | A-603354 |
| 38 | At N = 510 - 1220 Min-1 To 09403057 | 1 | 629510.1 | A-629510.1 |
| 42 | For Hph - G Chopper | 1 | 680334.1 | A-680334.1 |
| 43 | For Suction Blower | 1 | 644448.0 | A-644448 |



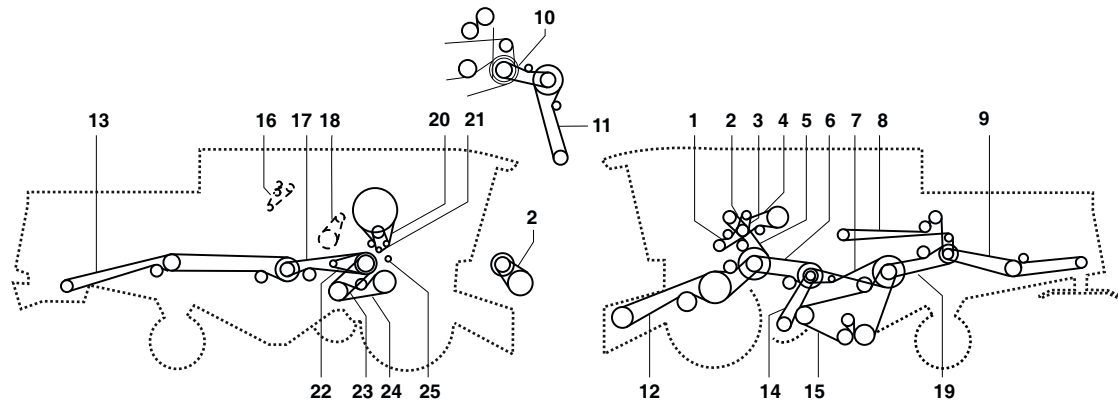

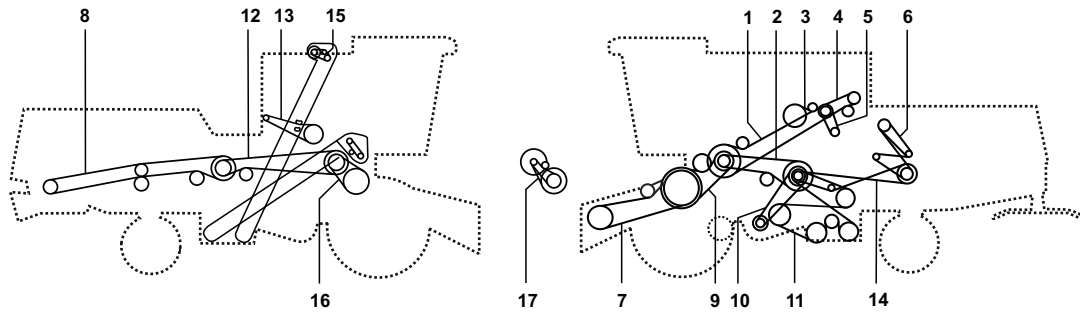

| Belt No. |  | No. of Belts | OEM  Part No. | PIX  Part No. |
|----------|---|--------------|--|--|
| 1 | - | 2 | 544049.1 | A-544049.1 |
| 2 | Mercedes Om 906 La | 1 | 656028.0 | A-656028.0 |
| 2 | Mercedes Om 366 La | 1 | 767057.1 | A-767057.1 |
| 3 | Mercedes Om 906 La | 1 | 621903.1 | A-621903.1 |
| 3 | Mercedes Om 366 La | 1 | 629908.1 | A-629908.1 |
| 4 | - | 1 | 660409.0 | A-660409.0 |
| 5 | Mercedes Om 906 La | 1 | 544083.0 | A-544083.0 |
| 5 | Mercedes Om 366 La | 1 | 644404.1 | A-644404.1 |
| 6 | - | 1 | 603337.0 | A-603337.0 |
| 7 | - | 1 | 644141.1 | A-644141.1 |
| 8 | - | 1 | 644447.0 | A-644447.0 |
| 9 | - | 1 | 623427.1 | A-623427.1 |
| 10 | - | 1 | 755070.1 | A-755070.1 |
| 11 | N = 519 | 1 | 066034.0 | A-066034.0 |
| 11 | N = 660 | 1 | 785341.0 | A-785341.0 |
| 12 | - | 1 | 661337.0 | A-661337.0 |
| 13 | From No. 09408297 | 1 | 644539.0 | A-644539.0 |
| 13 | To No. 09408296 | 1 | 061353.1 | A-061353.1 |
| 13 | For Corn | 1 | 061214.0 | A-061214.0 |
| 14 | - | 1 | 603380.1 | A-603380.1 |
| 15 | - | 1 | 609762.0 | A-609762.0 |
| 17 | From No. 09408297 | 1 | 644538.0 | A-644538.0 |
| 17 | To No. 09408296 | 1 | 060306.3 | A-060306.3 |
| 19 | - | 1 | 506671.2 | A-506671.2 |
| 20 | Mercedes Om 906 La | 1 | 545689.0 | A-545689.0 |
| 20 | Mercedes Om 366 La | 1 | 661345.0 | A-661345.0 |
| 21 | Mercedes Om 906 La | 1 | 545668.0 | A-545668.0 |
| 21 | Mercedes Om 366 La | 1 | 661244.0 | A-661244.0 |
| 22 | From No. 09408297 | 1 | 644537.0 | A-644537.0 |
| 22 | To No. 09408296 | 1 | 644448.0 | A-644448.0 |
| 23 | Two Stage Drive | 1 | 609823.0 | A-609823.0 |
| 24 | Drum Variable Speed Drive N = 650 - 1500 | 1 | 661220.1 | A-661220.1 |
| 24 | Drum Variable Speed Drive N = 250 - 1250 | 1 | 661298.0 | A-661298.0 |

CLAAS DOMINATOR 130-140-150



| Belt No. |  | No. of Belts | OEM  Part No. | PIX  Part No. |
|----------|---|--------------|--|--|
| 1 | Threshing Mechanism Drive | 1 | 628888.0 | A-628888.0 |
| 2 | Sieve Pan Drive | 1 | 724141.0 | A-724141.0 |
| 3 | Discharge Drive Grain Tank | 1 | 672351.0 | A-672351.0 |
| 4 | Hydraulic Ground Drive | 1 | 672350.0 | A-672350.0 |
| 5 | Air Conditioning Compressor Drive | 1 | 349065.0 | A-349065.0 |
| 6 | Intensive Separation System Drive | 1 | 802931.0 | A-802931.0 |
| 7 | Cutterbar Drive | 1 | 603290.0 | A-603290.0 |
| 8 | Chopper Drive | 1 | 061902.0 | A-061902.0 |
| 9 | Cutterbar Drive | 1 | 673638.1 | A-673638.1 |
| 10 | Fan Drive Variable Speed | 1 | 603380.1 | A-603380.1 |
| 11 | Sieve Pan Drive | 1 | 724247.1 | A-724247.1 |
| 12 | Chopper Drive | 2 | 061872.0 | A-061872.0 |
| 14 | Straw Walker Drive | 1 | 785176.0 | A-785176.0 |
| 16 | Drum Drive Variable Speed (n=650-1500 Rpm) | 1 | 661430.0 | A-661430.0 |
| 16 | Drum Drive Variable Speed (n=500-1400 Rpm) | 1 | 661430.0 | A-661430.0 |

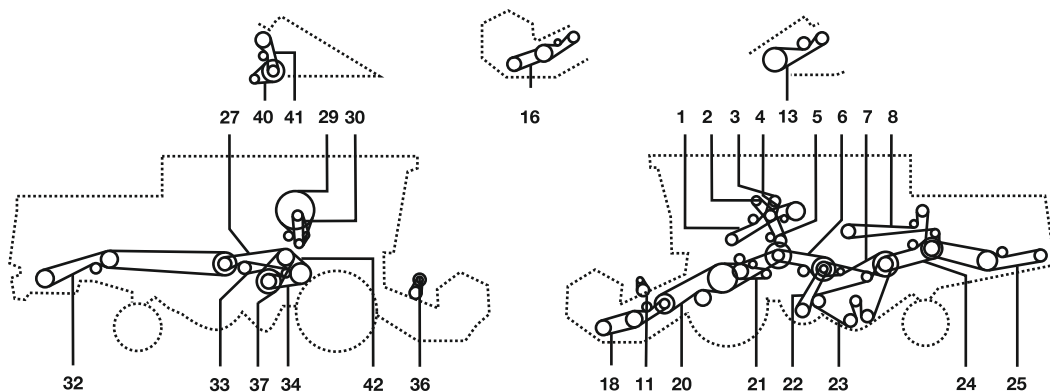

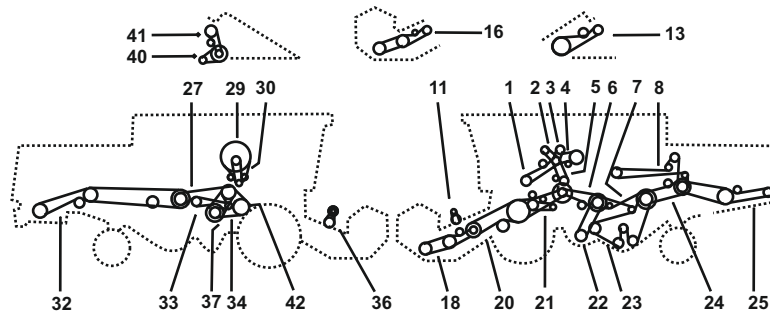

| Belt No. |  | No. of Belts | OEM  Part No. | PIX  Part No. |
|----------|---|--------------|--|--|
| 0 | For Two-stage Drive | 1 | 609823.0 | A-609823.0 |
| 0 | For Two-stage Drive | 1 | 661220.0 | A-661220.0 |
| 1 | Travel Drive | 1 | 661362.1 | A-661362.1 |
| 2 | Hydraulic Pump Drive | 1 | 767057.1 | A-767057.1 |
| 3 | Air Conditioning Compressor Drive | 1 | 629908.1 | A-629908.1 |
| 4 | Tank Unloader Drive | 1 | 629769.0 | A-629769.0 |
| 5 | Threshing Machine | 1 | 661458.0 | A-661458.0 |
| 6 | Countershaft Drive | 1 | 603337.0 | A-603337.0 |
| 7 | For Dominator 203 Mega | 1 | 603336.1 | A-603336.1 |
| 7 | For Dominator 204 Mega | 1 | 644141.1 | A-644141.1 |
| 11 | Reel Drive By 3.9 M - 5.1 M Cutting Table | 1 | 670224.1 | A-670224.1 |
| 13 | For Maize Picker | 1 | 692149.0 | A-692149.0 |
| 13 | For Maize Picker | 1 | 692150.0 | A-692150.0 |
| 13 | For Multimaster | 1 | 629142.0 | A-629142.0 |
| 16 | For 6.0 - 7.5 M Cutting Table | 1 | 671013.1 | A-671013.1 |
| 18 | Knife Drive 3.9 - 5.1 M Cutting Table | 1 | 713506.2 | A-713506.2 |
| 20 | Shaft Base 1306 Mm | 1 | 661337.0 | A-661337.0 |
| 20 | Shaft Base 1463 Mm | 1 | 661378.1 | A-661378.1 |
| 21 | Accelerator | 1 | 661031.0 | A-661031.0 |
| 22 | Blower - Dominator 203 Mega | 1 | 671209.0 | A-671209.0 |
| 22 | Blower - Dominator 204 Mega | 1 | 603380.1 | A-603380.1 |
| 23 | Shaker Shoe - Dominator 203 Mega | 2 | 603017.3 | A-603017.3 |
| 23 | Shaker Shoe - Dominator 204 Mega | 1 | 609762.0 | A-609762.0 |
| 24 | Straw Walker Drive | 1 | 506671.2 | A-506671.2 |
| 25 | Straw Distributor | 1 | 623427.1 | A-623427.1 |
| 27 | Straw Chopper Drive | 1 | 060306.2 | A-060306.2 |
| 29 | Cooler | 1 | 661345.0 | A-661345.0 |
| 30 | Countershaft Drive | 1 | 657793.0 | A-657793.0 |
| 32 | Straw Chopper (maize) | 1 | 061214.0 | A-061214.0 |
| 32 | Straw Chopper (grain) | 1 | 061360.0 | A-061360.0 |
| 33 | Dominator 204 Mega N=650-1500 Rpm | 1 | 609823.0 | A-609823.0 |
| 34 | Dominator 204 Mega N=650-1500 Rpm | 1 | 661220.0 | A-661220.0 |
| 35 | Reel Drive By 6.0 M - 7.5 M Cutting Table | 1 | 670224.1 | A-670224.1 |
| 37 | Air Exhaust | 1 | 644448.0 | A-644448.0 |
| 41 | Chopper Drive | 1 | 680334.1 | A-680334.1 |
| 43 | For Mercedes Engine Om 366 La | 1 | 133635.0 | A-133635.0 |

CLAAS DOMINATOR 218 - 208 MEGA



| Belt No. |  | No. of Belts | OEM  Part No. | PIX  Part No. |
|----------|---|--------------|--|--|
| 0 | Reel Drive By 2 - Step Gear | 1 | 661220.0 | A-661220.0 |
| 1 | Travel Drive - Om 366 La | 1 | 661451.0 | A-661451.0 |
| 1 | Travel Drive - Om 441 A | 1 | 661239.0 | A-661239.0 |
| 2 | Hydraulic Pump Drive (om 366) | 1 | 767057.1 | A-767057.1 |
| 2 | Hydraulic Pump Drive (om 441 A) | 1 | 633030.2 | A-633030.2 |
| 3 | Air Conditioning Compressor Drive - Om 366 La | 1 | 629908.1 | A-629908.1 |
| 3 | Air Conditioning Compressor Drive - Om 441 A | 1 | 661114.0 | A-661114.0 |
| 4 | Tank Unloading - Om 366 La | 1 | 660409.0 | A-660409.0 |
| 4 | Tank Unloading - Om 441 A | 1 | 661093.0 | A-661093.0 |
| 5 | Threshing Machine - Om 366 La | 1 | 644404.1 | A-644404.1 |
| 5 | Threshing Machine - Om 441 A | 1 | 644403.0 | A-644403.0 |
| 6 | Countershaft Drive | 1 | 603337.0 | A-603337.0 |
| 7 | - | 1 | 644141.1 | A-644141.1 |
| 8 | - | 1 | 644447.0 | A-644447.0 |
| 11 | Reel Drive By 4.5 M - 5.1 M | 1 | 670224.1 | A-670224.1 |
| 13 | For Multimaster | 1 | 692149.0 | A-692149.0 |
| 13 | For Multimaster | 1 | 692150.0 | A-692150.0 |
| 13 | For Multimaster | 1 | 629142.0 | A-629142.0 |
| 16 | Reel Drive By 6.0 M - 9.0 M | 1 | 671013.1 | A-671013.1 |
| 18 | Reel Drive By 4.5 M - 5.1 M | 1 | 713506.2 | A-713506.2 |
| 20 | Feeder Channel | 1 | 661378.1 | A-661378.1 |
| 21 | Feeder Drum | 1 | 661031.0 | A-661031.0 |
| 22 | Blower Drive | 1 | 603380.1 | A-603380.1 |
| 23 | Shaker Shoe Drive | 1 | 609762.0 | A-609762.0 |
| 24 | Straw Walker Drive | 1 | 506671.2 | A-506671.2 |
| 25 | Straw Distributor | 1 | 623427.1 | A-623427.1 |
| 27 | Straw Chopper Drive | 1 | 060306.2 | A-060306.2 |
| 30 | Cooler | 1 | 661345.0 | A-661345.0 |
| 31 | Countershaft - Om 366 La | 1 | 661244.0 | A-661244.0 |
| 31 | Countershaft - Om 441 A | 1 | 661245.0 | A-661245.0 |
| 33 | Straw Chopper (maize) | 1 | 061214.0 | A-061214.0 |
| 33 | Straw Chopper (grain) | 1 | 061353.0 | A-061353.0 |
| 34 | Trommelvorlege | 1 | 609823.0 | A-609823.0 |
| 35 | Reel Drive By N=510-1400 Rpm | 1 | 661298.0 | A-661298.0 |
| 35 | Reel Drive By N=650-1500 Rpm | 1 | 661220.0 | A-661220.0 |
| 36 | Reel Drive By 6.0 M - 9.0 M | 1 | 670224.1 | A-670224.1 |
| 41 | Chopper Drive | 1 | 680334.1 | A-680334.1 |
| 42 | For Air Exhaust | 1 | 644448.0 | A-644448.0 |

CLAAS EUROPA



| Belt No. |  | No. of Belts | OEM  Part No. | PIX  Part No. |
|----------|---|--------------|--|--|
| 1 | Baler | 1 | 506880.0 | A-506880 |
| 2 | Countershaft - Straw Chopper | 1 | 801221.0 | A-801221 |
| 2 | Knife Drive | 1 | 756051.0 | A-756051 |
| 3 | Tank Unloader Drive | 1 | 756059.0 | A-756059 |
| 3 | Tank Unloader Drive | 1 | 756051.0 | A-756051 |
| 4 | Radiator Fan Drive | 1 | 758719.0 | A-758719 |
| 4 | Radiator Fan Drive | 1 | 758662.0 | A-758662 |
| 5 | Cutting Table Drive | 1 | 772657.0 | A-772657 |
| 6 | Spreader Grain In Tank | 1 | 775698.0 | A-775698 |
| 7 | Pick Up Drive | 1 | 800309.0 | A-800309 |
| 8 | Straw Chopper Drive | 1 | 506940.0 | A-506940 |
| 10 | Hydraulic Pump Drive | 1 | 755070.0 | A-755070 |
| 11 | Traction Drive | 1 | 750316.0 | A-750316 |
| 12 | Threshing Machine | 1 | 750888.0 | A-750888 |
| 13 | Traction Drive | 1 | 751112.0 | A-751112 |
| 14 | Shaker Shoe Fanbaler | 1 | 772658.0 | A-772658 |
| 15 | Straw Walker Elevator | 1 | 774100.0 | A-774100 |
| 15 | Straw Walker Elevator | 1 | 773313.0 | A-773313 |
| 16 | Countershaft - Straw Chopper | 1 | 801221.0 | A-801221 |
| 22 | Chaff Spreader Drive (lower) | 1 | 123306A1 | A-123306A1 |

CLAAS JAGUAR 60

| Belt No. |  | No. of Belts | OEM  Part No. | PIX  Part No. |
|----------|---|--------------|--|--|
| 4 | ANGLE Gear BOX N=1000 RPM | 1 | 211148.1 | A-211148.1 |

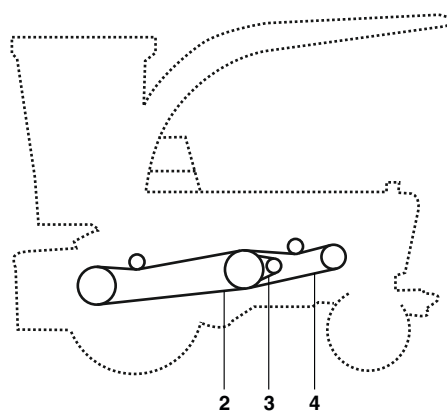
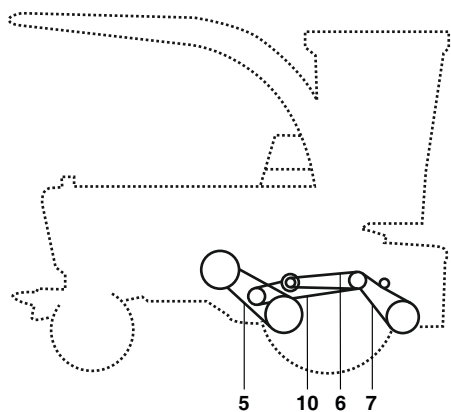

CLAAS JAGUAR 70 SF

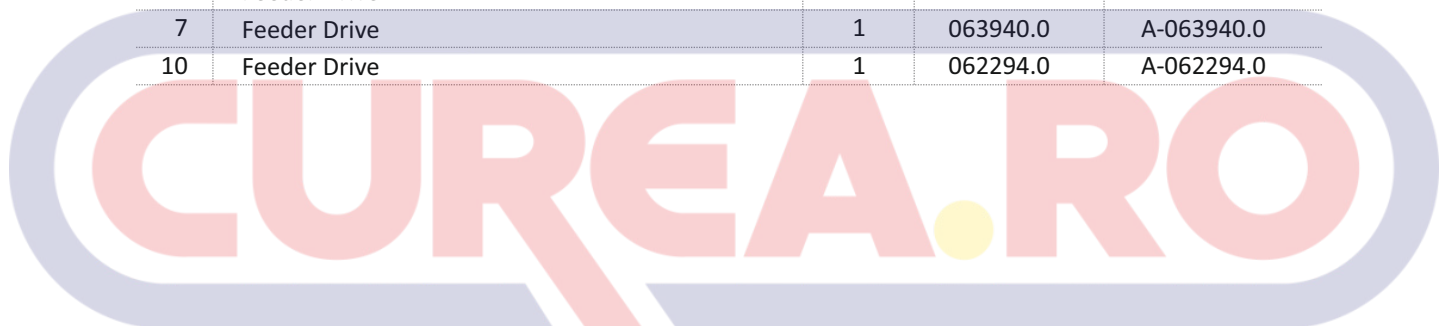

| Belt No. |  | No. of Belts | OEM  Part No. | PIX  Part No. |
|----------|---|--------------|--|--|
| 2 | Drum Drive Variable Speed | 1 | 063309.0 | A-063309.0 |
| 3 | Hydraulic Pump Drive | 1 | 633030.1 | A-633030.1 |
| 4 | Engine | 1 | 063285.0 | A-063285.0 |
| 5 | Drum Drive Variable Speed | 1 | 629412.0 | A-629412.0 |
| 5 | Drum Drive Variable Speed | 1 | 629737.0 | A-629737.0 |
| 6 | Feeder Drive | 1 | 618123.0 | A-618123.0 |
| 7 | Feeder Drive | 1 | 063940.0 | A-063940.0 |
| 10 | Feeder Drive | 1 | 062294.0 | A-062294.0 |

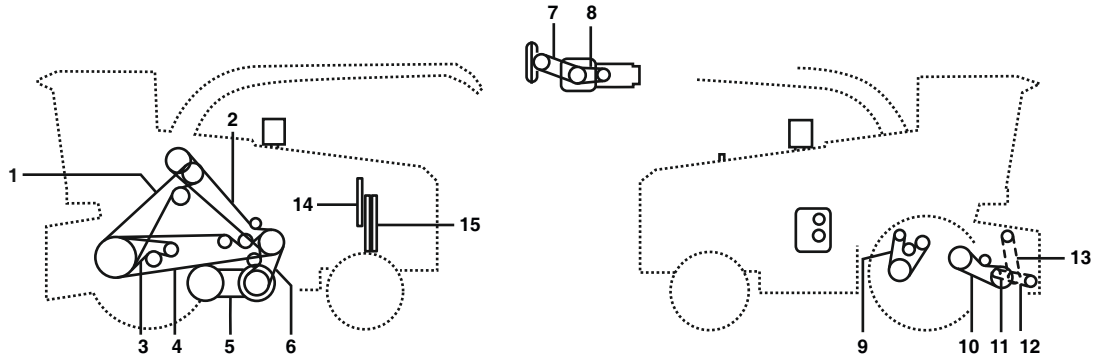







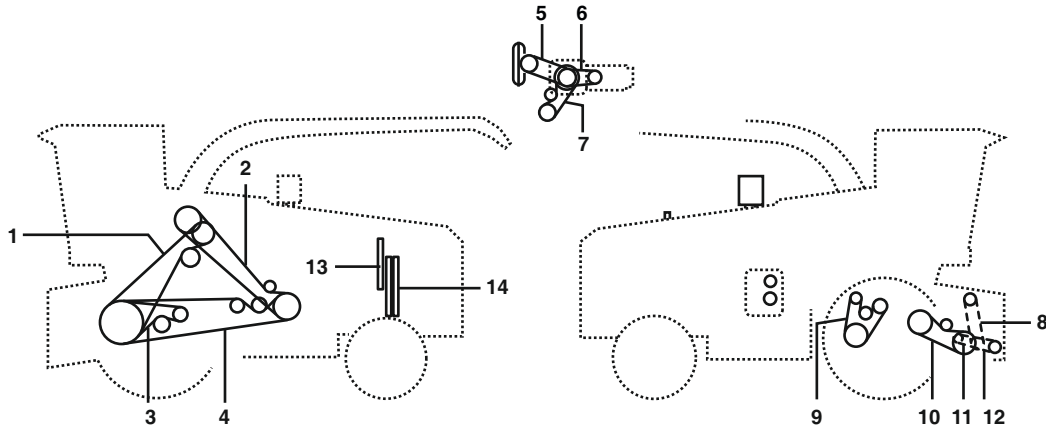

| Belt No. |  | No. of Belts | OEM  Part No. | PIX  Part No. |
|----------|---|--------------|--|--|
| 1 | Feeder Drive | 2 | 629836.0 | A-629836.0 |
| 2 | - | 1 | 070310.1 | A-070310.1 |
| 3 | For Corn - Cracker | 1 | 629769.0 | A-629769.0 |
| 4 | - | 1 | 070953.1 | A-070953.1 |
| 5 | - | 1 | 609823.0 | A-609823.0 |
| 6 | - | 1 | 644016.1 | A-644016.1 |
| 7 | For Hydraulic Pump | 1 | 750193.2 | A-750193.2 |
| 8 | For Air Conditioning | 1 | 659025.0 | A-659025.0 |
| 9 | For Corn - Cracker | 1 | 072110.0 | A-072110.0 |
| 10 | - | 1 | 673614.0 | A-673614.0 |
| 14 | For Alternator At Om 421 | 1 | 133528.0 | A-133528.0 |
| 15 | Cooling At Om 421 | 2 | 133630.1 | A-133630.1 |
| 15 | Cooling and Alternator At Om 360 | 2 | 685693.0 | A-685693.0 |

CLAAS JAGUAR 675 HYDRO

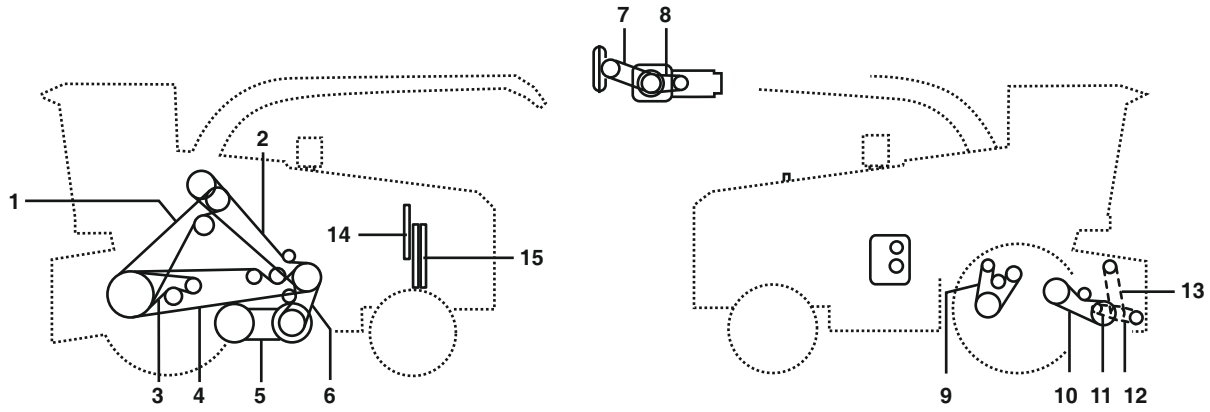





| Belt No. |  | No. of Belts | OEM  Part No. | PIX  Part No. |
|----------|---|--------------|--|--|
| 1 | Feeder Drive | 2 | 629836.0 | A-629836.0 |
| 2 | - | 1 | 070310.1 | A-070310.1 |
| 3 | For Corn Cracker | 1 | 629769.0 | A-629769.0 |
| 4 | - | 1 | 070953.1 | A-070953.1 |
| 5 | For Hydraulic Pump | 1 | 750193.2 | A-750193.2 |
| 6 | For Air Conditioning | 1 | 659025.0 | A-659025.0 |
| 7 | - | 1 | 176543.1 | A-176543.1 |
| 9 | For Corn Cracker | 1 | 072110.0 | A-072110.0 |
| 10 | - | 1 | 673614.0 | A-673614.0 |
| 13 | For Alternator | 1 | 133528.0 | A-133528.0 |
| 14 | For Cooling | 2 | 133630.1 | A-133630.1 |



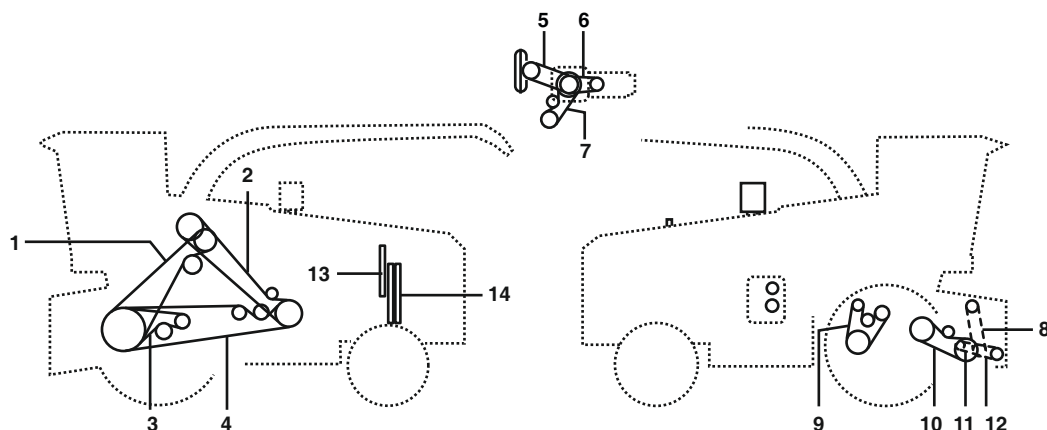

| Belt No. |  | No. of Belts | OEM  Part No. | PIX  Part No. |
|----------|---|--------------|--|--|
| 1 | Feeder Drive | 2 | 629836.0 | A-629836.0 |
| 2 | - | 1 | 070310.1 | A-070310.1 |
| 3 | For Corn Cracker | 1 | 629769.0 | A-629769.0 |
| 4 | - | 1 | 070953.1 | A-070953.1 |
| 5 | - | 1 | 609823.0 | A-609823.0 |
| 6 | - | 1 | 644016.1 | A-644016.1 |
| 7 | For Hydraulic Pump | 1 | 750193.2 | A-750193.2 |
| 8 | For Air Conditioning | 1 | 659025.0 | A-659025.0 |
| 9 | For Corn Cracker | 1 | 072110.0 | A-072110.0 |
| 10 | - | 1 | 673614.0 | A-673614.0 |
| 14 | For Alternator At Om 421 | 1 | 133528.0 | A-133528.0 |
| 15 | Cooling At Om 421 | 2 | 133630.1 | A-133630.1 |
| 15 | Cooling and Alternator At Om 360 | 2 | 685693.0 | A-685693.0 |

CLAAS JAGUAR 680 HYDRO



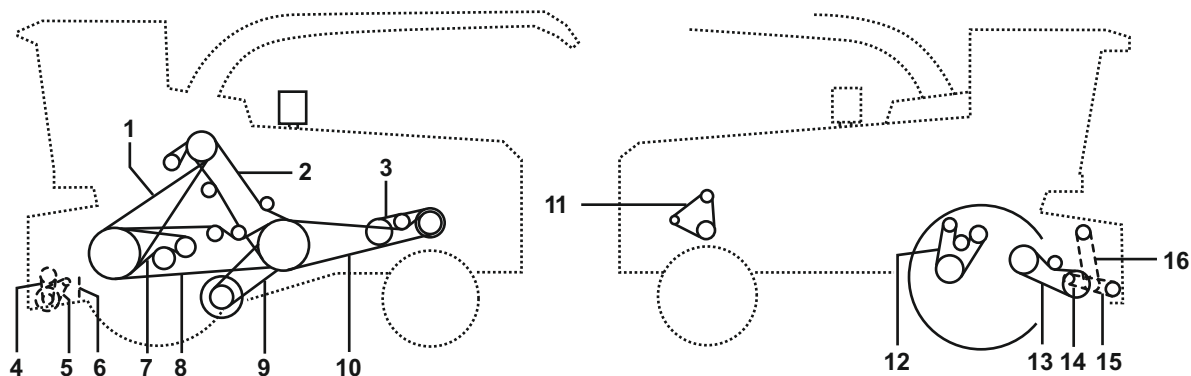

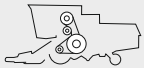

| Belt No. |  | No. of Belts | OEM  Part No. | PIX  Part No. |
|----------|---|--------------|--|--|
| 1 | - | 2 | 629836.0 | A-629836.0 |
| 2 | - | 1 | 070310.1 | A-070310.1 |
| 3 | For Corn Cracker | 1 | 629769.0 | A-629769.0 |
| 4 | - | 1 | 070953.1 | A-070953.1 |
| 5 | For Hydraulic Pump | 1 | 750193.2 | A-750193.2 |
| 7 | - | 1 | 176543.1 | A-176543.1 |
| 9 | For Corn Cracker | 1 | 072110.0 | A-072110.0 |
| 10 | - | 1 | 673614.0 | A-673614.0 |
| 13 | For Alternator | 1 | 133528.0 | A-133528.0 |
| 14 | For Cooling | 2 | 133630.1 | A-133630.1 |



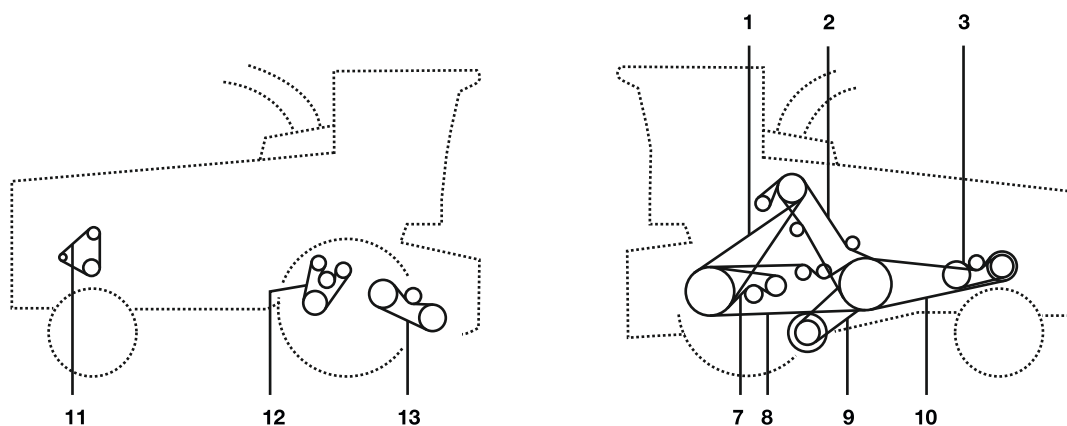



| Belt No. |  | No. of Belts | OEM  Part No. | PIX  Part No. |
|----------|---|--------------|--|--|
| 2 | For Slip Drive | 1 | 070310.1 | A-070310.1 |
| 3 | For Hydraulic Pump From No. 18600322 | 1 | 634019.1 | A-634019.1 |
| 3 | For Hydraulic Pump To No. 18600321 | 1 | 750294.0 | A-750294.0 |
| 7 | For Corn Cracker | 1 | 629763.0 | A-629763.0 |
| 8 | For Chopper Drum | 1 | 073202.1 | A-073202.1 |
| 9 | At Mechanical Ground Drive | 1 | 629756.0 | A-629756.0 |
| 9 | At Hydraulic Ground Drive | 1 | 073203.0 | A-073203.0 |
| 10 | Motor - Intermediate Drive From No. 18600322 | 1 | 073199.0 | A-073199.0 |
| 10 | Motor - Intermediate Drive To No. 18600321 | 1 | 073201.1 | A-073201.1 |
| 11 | Alternator Mercedes From No. 18600322 | 1 | 133641.0 | A-133641.0 |
| 11 | Alternator Perkins To No. 18600321 | 1 | 602387.1 | A-602387.1 |
| 12 | For Corn Cracker | 1 | 073204.0 | A-073204.0 |
| 13 | At 4g - Chain Drive | 1 | 644015.1 | A-644015.1 |
| 13 | At 6g - Transmission | 1 | 673614.0 | A-673614.0 |

CLAAS JAGUAR 682 S - SL

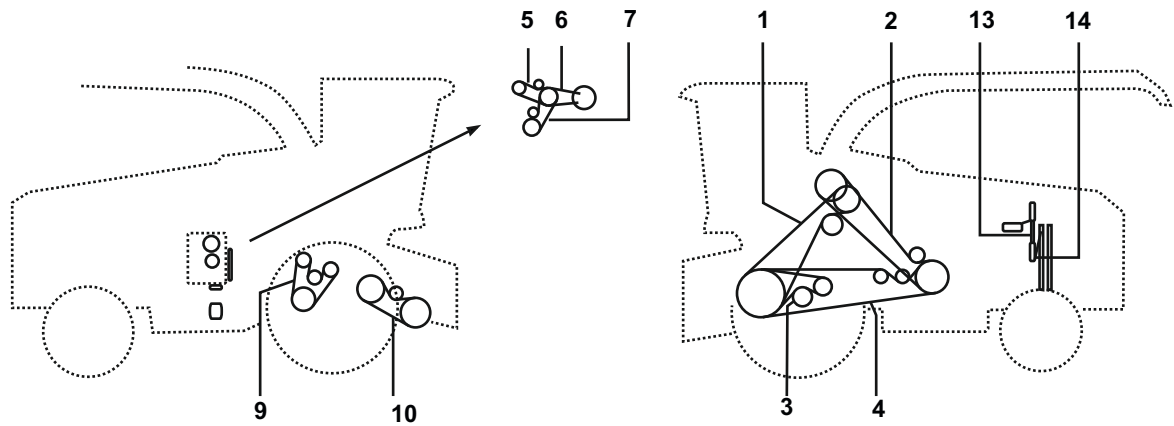





| Belt No. |  | No. of Belts | OEM  Part No. | PIX  Part No. |
|----------|---|--------------|--|--|
| 2 | Straw Walker Drive | 1 | 070310.1 | A-070310.1 |
| 3 | Hydraulic Pump Drive | 1 | 750294.0 | A-750294.0 |
| 7 | Corn Cracker Drive | 1 | 629763.0 | A-629763.0 |
| 8 | Threshing Drum Variator Drive | 1 | 073202.0 | A-073202.0 |
| 9 | Hydrostatic Speed Drive | 1 | 073203.0 | A-073203.0 |
| 9 | Mechanical Drive | 1 | 629756.0 | A-629756.0 |
| 10 | Engine | 1 | 073201.0 | A-073201.0 |
| 11 | Alternator Drive | 1 | 602387.0 | A-602387.0 |
| 12 | Corn Cracker Drive | 1 | 073204.0 | A-073204.0 |
| 13 | Feeder Drive | 1 | 644015.1 | A-644015.1 |
| 13 | Feeder Drive | 1 | 673614.0 | A-673614.0 |

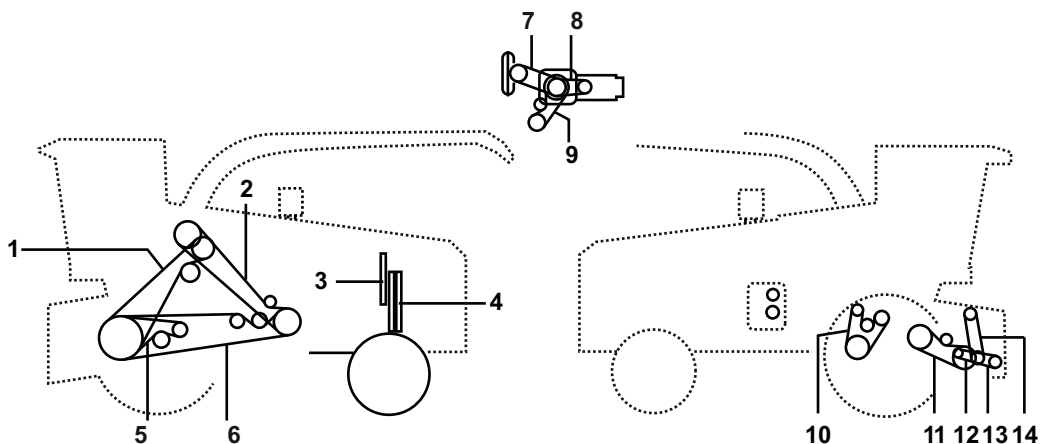

| Belt No. |  | No. of Belts | OEM  Part No. | PIX  Part No. |
|----------|---|--------------|--|--|
| 1 | Drum Drive | 2 | 629836.0 | A-629836.0 |
| 2 | Feeder Drive | 1 | 070310.1 | A-070310.1 |
| 3 | Left Corn-cracker Drive | 1 | 629769.0 | A-629769.0 |
| 4 | Head Drum Drive | 1 | 070952.2 | A-070952.2 |
| 5 | Hydraulic Pump Drive | 1 | 750193.2 | A-750193.2 |
| 6 | Air Conditioning Compressor Drive | 1 | 659025.0 | A-659025.0 |
| 7 | Hydraulic Speed Drive | 1 | 673625.0 | A-673625.0 |
| 7 | Hydraulic Speed Drive | 1 | 176543.0 | A-176543.0 |
| 9 | Corn - Cracker Drive Right | 1 | 072110.0 | A-072110.0 |
| 10 | Chopper Drive | 1 | 673614.0 | A-673614.0 |
| 13 | Alternator Drive | 1 | 133528.0 | A-133528.0 |
| 14 | Cooling Fan | 1 | 133630.0 | A-133630.0 |
| 15 | For Combine Platform | 1 | 673614.0 | A-673614.0 |



CLAAS JAGUAR 690 SL





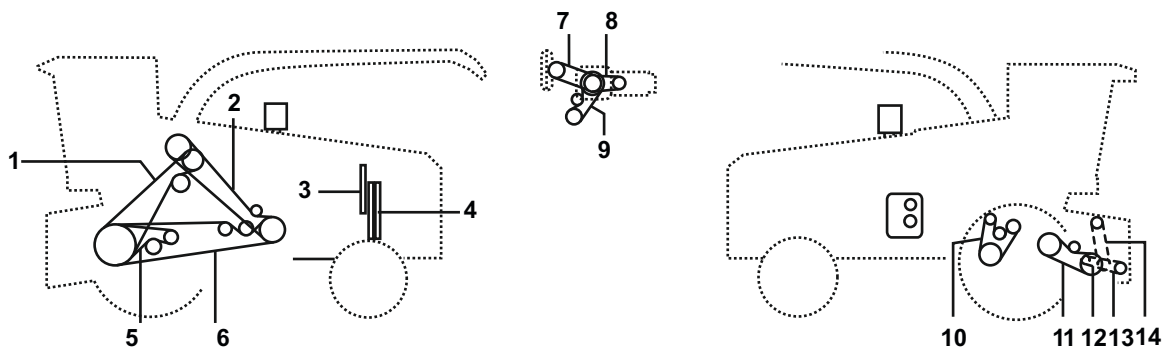

| Belt No. |  | No. of Belts | OEM  Part No. | PIX  Part No. |
|----------|---|--------------|--|--|
| 1 | For Accelerator | 2 | 629836.0 | A-629836.0 |
| 2 | For Slip Drive | 1 | 070310.1 | A-070310.1 |
| 3 | For Alternator | 1 | 133528.0 | A-133528.0 |
| 4 | For Motor Cooling | 1 | 133630.1 | A-133630.1 |
| 5 | For Corn Cracker | 1 | 629763.0 | A-629763.0 |
| 6 | At Jaguar 690 Sl from No. 18800012 | 1 | 074803.2 | A-074803.2 |
| 6 | At Jaguar 690 Sl to No. 18800011 | 1 | 070952.2 | A-070952.2 |
| 7 | For Hydraulic Pump | 1 | 750193.2 | A-750193.2 |
| 8 | For Air Conditioning | 1 | 659025.0 | A-659025.0 |
| 9 | For Ground Drive | 1 | 176543.1 | A-176543.1 |
| 10 | For Corn Cracker | 1 | 073204.0 | A-073204.0 |
| 11 | For Feeder Drive | 1 | 673614.0 | A-673614.0 |

CLAAS JAGUAR 695 - 685 SL

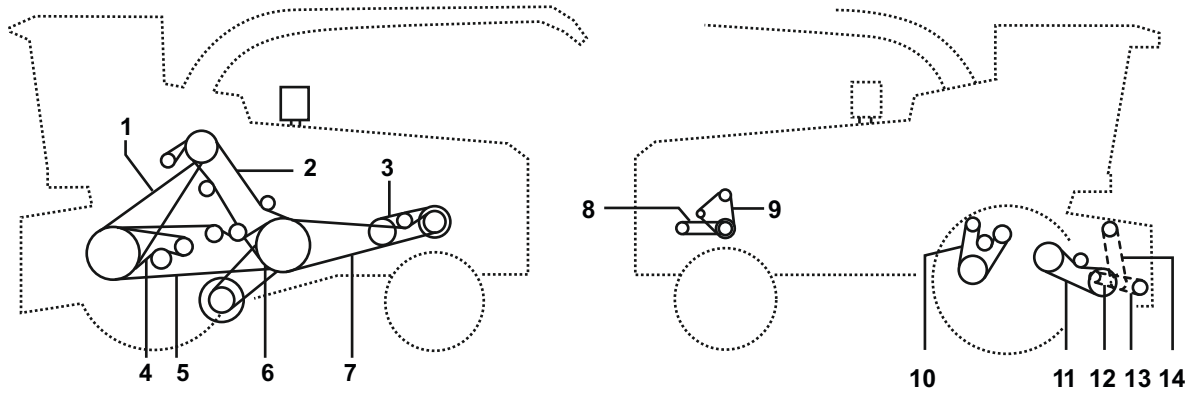



| Belt No. |  | No. of Belts | OEM  Part No. | PIX  Part No. |
|----------|---|--------------|--|--|
| 1 | Drum Drive | 2 | 629836.0 | A-629836.0 |
| 2 | Feeder Drive | 1 | 070310.1 | A-070310.1 |
| 3 | Alternator Drive | 1 | 133528.0 | A-133528.0 |
| 4 | Cooling Fan | 1 | 133630.0 | A-133630.0 |
| 5 | Corn Cracker drive | 1 | 629763.0 | A-629763.0 |
| 6 | For Jaguar 690/685 SI | 1 | 070952.2 | A-070952.2 |
| 6 | For Jaguar 690/685 SI | 1 | 074803.1 | A-074803.1 |
| 6 | For Jaguar 695 SI | 1 | 074771.1 | A-074771.1 |
| 7 | Hydraulic Pump Drive | 1 | 750193.2 | A-750193.2 |
| 8 | Air Conditioning Compressor Drive | 1 | 659025.0 | A-659025.0 |
| 9 | Drum Drive Variable Speed | 1 | 176543.0 | A-176543.0 |
| 10 | Corn Cracker drive | 1 | 073204.0 | A-073204.0 |
| 11 | Feeder Drive | 1 | 673614.0 | A-673614.0 |
| 15 | For Combine Platform | 1 | 673614.0 | A-673614.0 |



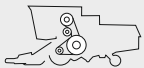

| Belt No. |  | No. of Belts | OEM  Part No. | PIX  Part No. |
|----------|---|--------------|--|--|
| 2 | For Slip Drive | 1 | 070310.1 | A-070310.1 |
| 3 | For Hydraulic Pump | 1 | 634019.1 | A-634019.1 |
| 4 | For Corn Cracker | 1 | 629763.0 | A-629763.0 |
| 5 | For Chopper Drum | 1 | 073202.1 | A-073202.1 |
| 6 | At Mechanical Ground Drive | 1 | 629756.0 | A-629756.0 |
| 6 | At Hydraulic Ground Drive | 1 | 073203.0 | A-073203.0 |
| 7 | Motor - Intermediate Drive | 1 | 073199.0 | A-073199.0 |
| 8 | For Air Conditioning | 1 | 667560.1 | A-667560.1 |
| 9 | For Alternator | 1 | 133641.0 | A-133641.0 |
| 10 | For Corn Cracker | 1 | 073204.0 | A-073204.0 |
| 11 | For Feeder Housing | 1 | 673614.1 | A-673614.1 |



CLAAS JAGUAR 820 - 840

| Belt No. |  | No. of Belts | OEM  Part No. | PIX  Part No. |
|----------|---|--------------|--|--|
| 1 | Main Drive For Jaguar 820 | 1 | 077797.0 | A-077797.0 |
| 1 | Main Drive For Jaguar 840 | 1 | 077796.0 | A-077796.0 |
| 2 | Alternator Drive | 1 | 512087.0 | A-512087 |
| 3 | Compressor Drive | 1 | 052393.1 | A-052393.1 |
| 4 | Fan Drive | 1 | 077400.0 | A-077400.0 |
| 5 | Cleaning Fan Drive | 1 | 077276.0 | A-077276.0 |
| 6 | Corn Cracker Drive | 1 | 076403.1 | A-076403.1 |

CLAAS JAGUAR 830

| Belt No. |  | No. of Belts | OEM  Part No. | PIX  Part No. |
|----------|---|--------------|--|--|
| 1 | Main Drive | 1 | 067745.0 | A-067745.0 |
| 2 | Fan Drive For Om 502 La | 1 | 067289.0 | A-067289.0 |
| 2 | Fan Drive For Om 457 La | 1 | 067290.0 | A-067290.0 |
| 2 | Fan Drive For Om 460 La | 1 | 142232.0 | A-142232 |
| 3 | Corn Cracker Drive | 1 | 076403.1 | A-076403.1 |
| 3 | Corn Cracker Drive | 1 | 067789.0 | A-067789.0 |
| 4 | Chopper Drive | 1 | 984885.0 | A-984885 |



CLAAS JAGUAR 850

| Belt No. |  | No. of Belts | OEM  Part No. | PIX  Part No. |
|----------|---|--------------|--|--|
| 1 | Main Drive | 1 | 067746.0 | A-067746.0 |
| 2 | Fan Drive For Om 502 La | 1 | 067289.0 | A-067289.0 |
| 2 | Fan Drive For Om 457 La | 1 | 067290.0 | A-067290.0 |
| 2 | Fan Drive For Om 460 La | 1 | 142232.0 | A-142232 |
| 3 | Corn Cracker Drive | 1 | 076403.1 | A-076403.1 |
| 3 | Corn Cracker Drive | 1 | 067789.0 | A-067789.0 |
| 4 | Chopper Drive | 1 | 984885.0 | A-984885 |



CLAAS JAGUAR 870

| Belt No. |  | No. of Belts | OEM  Part No. | PIX  Part No. |
|----------|---|--------------|--|--|
| 1 | Main Drive | 1 | 067746.0 | A-067746.0 |
| 2 | Fan Drive For Om 502 La | 1 | 067289.0 | A-067289.0 |
| 2 | Fan Drive For Om 457 La | 1 | 067290.0 | A-067290.0 |
| 2 | Fan Drive For Om 460 La | 1 | 142232.0 | A-142232 |
| 3 | Corn Cracker Drive | 1 | 076403.1 | A-076403.1 |
| 3 | Corn Cracker Drive | 1 | 067789.0 | A-067789.0 |
| 4 | Chopper Drive | 1 | 984885.0 | A-984885 |

CLAAS JAGUAR 890



| Belt No. |  | No. of Belts | OEM  Part No. | PIX  Part No. |
|----------|---|--------------|--|--|
| 1 | Main Drive | 1 | 067747.1 | A-067747.1 |
| 2 | Fan Drive For Om 502 La | 1 | 067289.0 | A-067289.0 |
| 2 | Fan Drive For Om 457 La | 1 | 067290.0 | A-067290.0 |
| 2 | Fan Drive For Om 460 La | 1 | 142232.0 | A-142232 |
| 3 | Corn Cracker Drive | 1 | 076403.1 | A-076403.1 |
| 3 | Corn Cracker Drive | 1 | 067789.0 | A-067789.0 |
| 4 | Chopper Drive | 1 | 984885.0 | A-984885 |

CLAAS JAGUAR 900

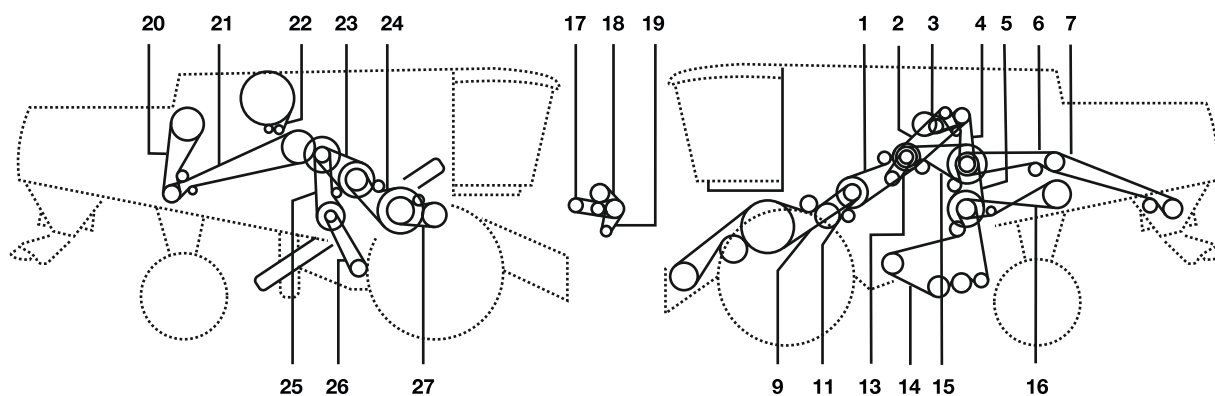

| Belt No. |  | No. of Belts | OEM  Part No. | PIX  Part No. |
|----------|---|--------------|--|--|
| 1 | Main Drive | 1 | 067747.1 | A-067747.1 |
| 2 | Fan Drive For Om 502 La | 1 | 067289.0 | A-067289.0 |
| 2 | Fan Drive For Om 457 La | 1 | 067290.0 | A-067290.0 |
| 2 | Fan Drive For Om 460 La | 1 | 142232.0 | A-142232 |
| 3 | Corn Cracker Drive | 1 | 076403.1 | A-076403.1 |
| 3 | Corn Cracker Drive | 1 | 067789.0 | A-067789.0 |
| 4 | Chopper Drive | 1 | 984885.0 | A-984885 |

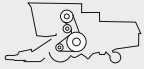
CLAAS LEXION 410 - 405



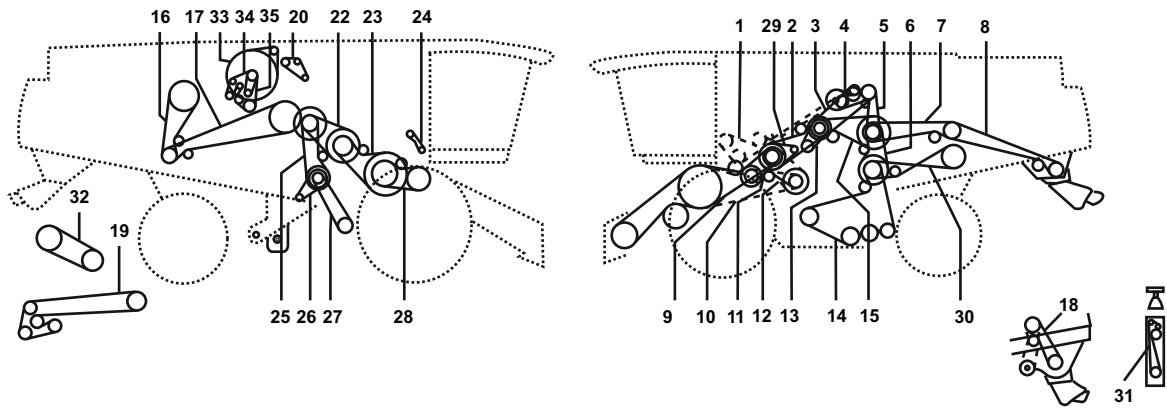



| Belt No. |  | No. of Belts | OEM  Part No. | PIX  Part No. |
|----------|---|--------------|--|--|
| 0 | Threshing Drum Variator drive | 1 | 667248.0 | A-667248.0 |
| 0 | Knife Drive | 1 | 742025.0 | A-742025.0 |
| 0 | Reel Drive Variable Speed | 1 | 670244.1 | A-670244.1 |
| 1 | Cutterbar Drive | 1 | 667947.0 | A-667947.0 |
| 2 | Threshing Machine | 1 | 667680.0 | A-667680.0 |
| 3 | Discharge Drive Grain Tank | 1 | 667681.0 | A-667681.0 |
| 4 | Straw Chopper Drive - 1st Stage | 1 | 667981.2 | A-667981.2 |
| 5 | Sieve Pan Drive - 2nd Stage | 1 | 667252.0 | A-667252.0 |
| 6 | Straw Chopper Drive - 2nd Stage | 1 | 667683.0 | A-667683.0 |
| 7 | Straw Chopper Drive - 2nd Stage | 1 | 644771.0 | A-644771.0 |
| 9 | Cutterbar Drive | 2 | 667454.0 | A-667454.0 |
| 11 | Impeller Drum Drive | 1 | 667249.0 | A-667249.0 |
| 13 | Hydraulic Pump Drive | 1 | 758719.0 | A-758719.0 |
| 14 | Sieve Pan Drive 2nd Stage | 1 | 667651.0 | A-667651.0 |
| 15 | Sieve Pan Drive - 1st Stage | 1 | 644209.0 | A-644209.0 |
| 16 | Straw Walker Drive | 1 | 667477.0 | A-667477.0 |
| 17 | Compressor Drive | 1 | 667560.1 | A-667560.1 |
| 18 | Rotary Screen Fan and Drive | 1 | 667242.0 | A-667242.0 |
| 19 | Alternator Drive Starter | 1 | 667673.0 | A-667673.0 |
| 20 | Agitator Drive (rear) | 1 | 667973.0 | A-667973.0 |
| 21 | Agitator Drive (front) | 1 | 667974.0 | A-667974.0 |
| 22 | Rotary Screen Drive | 1 | 667561.1 | A-667561.1 |
| 23 | Threshing Drum Variator drive | 1 | 661427.0 | A-661427.0 |
| 24 | Threshing Cylinder | 1 | 667934.0 | A-667934.0 |
| 25 | Fan Drive - 1st Stage | 1 | 667957.0 | A-667957.0 |
| 26 | Fan Intermediate Drive | 1 | 667457.0 | A-667457.0 |
| 27 | Threshing Drum Variator drive | 1 | 667251.0 | A-667251.0 |



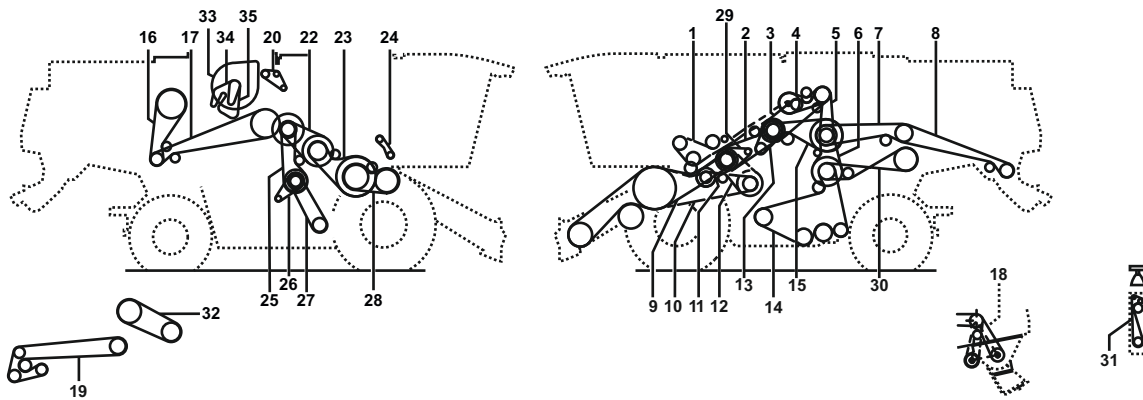



| Belt No. |  | No. of Belts | OEM  Part No. | PIX  Part No. |
|----------|---|--------------|--|--|
| 2 | Cutterbar Drive, 1ste Stage | 1 | 667255.0 | A-667255.0 |
| 3 | Threshing Mechanism Drive | 1 | 352371.1 | A-352371.1 |
| 4 | Grain Tank Unloading | 1 | 667250.0 | A-667250.0 |
| 5 | Chopper Drive 1ste Stage | 1 | 667958.3 | A-667958.3 |
| 6 | Sieve Pan, 2nd Stage | 1 | 667252.0 | A-667252.0 |
| 7 | Chopper Drive, 2nd Stage | 1 | 667683.1 | A-667683.1 |
| 8 | Chopper Drive, 3rd Stage Adjustable Chopper | 1 | 667683.1 | A-667683.1 |
| 8 | Chopper Drive, 3rd Stage Rigid Chopper | 1 | 061701.2 | A-061701.2 |
| 9 | Cutterbar Drive, 2nd Stage Without Vari. Speed Drive | 2 | 667454.0 | A-667454.0 |
| 10 | Cutterbar Drive, 2nd Stage With Vari. Speed Drive | 2 | 667551.1 | A-667551.1 |
| 11 | Synchronous Drive | 1 | 667249.0 | A-667249.0 |
| 12 | Cutterbar Variator | 1 | 667530.1 | A-667530.1 |
| 13 | Chaff Spreader | 1 | 758719.0 | A-758719.0 |
| 14 | Cleaning, 3rd Stage | 1 | 667651.0 | A-667651.0 |
| 15 | Cleaning, 1st Stage | 1 | 644209.0 | A-644209.0 |
| 16 | Intensive Separation System, Short | 1 | 667973.0 | A-667973.0 |
| 17 | Intensive Separation System, Long | 1 | 667974.0 | A-667974.0 |
| 18 | Chopper Drive, 4th Stage | 1 | 667684.0 | A-667684.0 |
| 19 | Finger Roller | 1 | 509035.1 | A-509035.1 |
| 22 | Lexion 410 | 1 | 661427.0 | A-661427.0 |
| 23 | Lexion 410 | 1 | 644902.0 | A-644902.0 |
| 25 | Lexion 410 | 1 | 667957.0 | A-667957.0 |
| 26 | Lexion 410 | 1 | 644843.0 | A-644843.0 |
| 27 | Fan Variator | 1 | 667457.0 | A-667457.0 |
| 28 | Pre - Drum Drive | 1 | 667251.1 | A-667251.1 |
| 29 | Hydraulic Reel Drive | 1 | 829094.0 | A-829094.0 |
| 30 | Straw Walker Drive | 1 | 667477.0 | A-667477.0 |
| 31 | Straw Spreader | 1 | 539443.0 | A-539443.0 |
| 32 | Drum Variator 2nd Stage | 1 | 667248.0 | A-667248.0 |
| 33 | Radiator Screen 2nd Stage | 1 | 545689.0 | A-545689.0 |
| 35 | Fan Drive | 1 | 796450.0 | A-796450.0 |

CLAAS LEXION 420 MONTANA

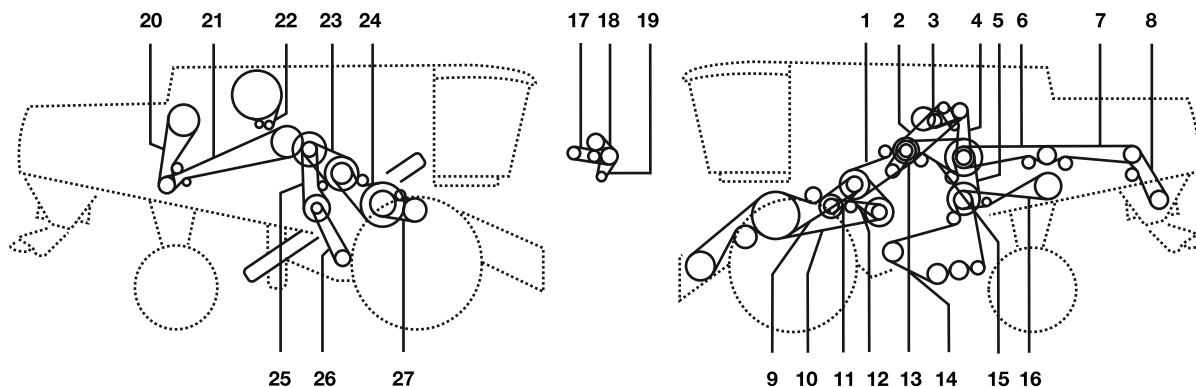

| Belt No. |  | No. of Belts | OEM  Part No. | PIX  Part No. |
|----------|---|--------------|--|--|
| 2 | Cutterbar Drive, 1ste Stage | 1 | 667255.0 | A-667255.0 |
| 3 | Threshing Mechanism Drive | 1 | 352371.1 | A-352371.1 |
| 4 | Grain Tank Unloading | 1 | 667250.0 | A-667250.0 |
| 5 | Chopper Drive, 1ste Stage | 1 | 667958.3 | A-667958.3 |
| 6 | Sieve Pan, 2nd Stage | 1 | 667252.0 | A-667252.0 |
| 7 | Chopper Drive, 2nd Stage | 1 | 667683.1 | A-667683.1 |
| 8 | Chopper Drive, 3rd Stage Adjustable Chopper | 1 | 667683.1 | A-667683.1 |
| 9 | Cutterbar Drive, 2nd Stage Without Vari. Speed Drive | 2 | 667454.0 | A-667454.0 |
| 10 | Cutterbar Drive, 3rd Stage With Vari. Speed Drive | 2 | 667551.1 | A-667551.1 |
| 11 | Synchronous Drive | 1 | 667249.0 | A-667249.0 |
| 12 | Cutterbar Variator | 1 | 667530.0 | A-667530.0 |
| 13 | Chaff Spreader | 1 | 758719.0 | A-758719.0 |
| 14 | Cleaning, 3rd Stage | 1 | 667651.0 | A-667651.0 |
| 15 | Cleaning, 1ste Stage | 1 | 644209.0 | A-644209.0 |
| 16 | Intensive Separation System, Short | 1 | 667973.0 | A-667973.0 |
| 17 | Intensive Separation System, Long | 1 | 667974.0 | A-667974.0 |
| 18 | Chopper Drive, 4th Stage | 1 | 667684.0 | A-667684.0 |
| 19 | Finger Roller | 1 | 509035.1 | A-509035.1 |
| 22 | Drum Variator | 1 | 667248.0 | A-667248.0 |
| 23 | Drum Drive | 1 | 176442.1 | A-176442.1 |
| 25 | Fan Drive | 1 | 742026.0 | A-742026.0 |
| 26 | Suction Fan | 1 | 644781.0 | A-644781.0 |
| 27 | Fan Variator | 1 | 667457.0 | A-667457.0 |
| 28 | Pre - Drum Drive | 1 | 667251.1 | A-667251.1 |
| 29 | Hydraulic Reel Drive | 1 | 829094.0 | A-829094.0 |
| 30 | Straw Walker Drive | 1 | 667477.0 | A-667477.0 |
| 31 | Straw Spreader | 1 | 539443.0 | A-539443.0 |
| 32 | Drum Variator 2nd Stage | 1 | 667248.0 | A-667248.0 |
| 33 | Radiator Screen 2nd Stage | 1 | 545689.0 | A-545689.0 |
| 35 | Fan Drive | 1 | 796450.0 | A-796450.0 |



| Belt No. |  | No. of Belts | OEM  Part No. | PIX  Part No. |
|----------|---|--------------|--|--|
| 0 | Rotary Screen Drive | 1 | 667456.0 | A-667456.0 |
| 0 | Knife Drive | 1 | 742025.0 | A-742025.0 |
| 0 | Reel Drive Variable Speed | 1 | 670244.1 | A-670244.1 |
| 1 | Clutch Forcutterbar Drive | 1 | 667255.0 | A-667255.0 |
| 2 | Threshing Mechanical Drive | 1 | 667680.0 | A-667680.0 |
| 3 | Discharge Drive Grain Tank | 1 | 667681.0 | A-667681.0 |
| 4 | Straw Chopper Drive - 1st Stage | 1 | 667981.2 | A-667981.2 |
| 5 | Sieve Pan Drive - 2nd Stage | 1 | 667252.0 | A-667252.0 |
| 7 | Straw Chopper Drive - 2nd Stage | 1 | 667683.0 | A-667683.0 |
| 8 | Straw Chopper Drive - 4th Stage | 1 | 667684.0 | A-667684.0 |
| 9 | Cutterbar Drive Without Variator Drive | 2 | 667454.0 | A-667454.0 |
| 10 | Cutterbar Drive Without Variator Drive | 2 | 667551.0 | A-667551.0 |
| 11 | Impeller Drum Drive | 1 | 667249.0 | A-667249.0 |
| 12 | Cutterbar Drive With Variable Speed Drive | 1 | 667530.0 | A-667530.0 |
| 13 | Hydraulic Pump Drive | 1 | 758719.0 | A-758719.0 |
| 14 | Sieve Pan Drive 2nd Stage | 1 | 667651.0 | A-667651.0 |
| 15 | Sieve Pan Drive - 1st Stage | 1 | 644209.0 | A-644209.0 |
| 16 | Straw Walker Drive | 1 | 667477.0 | A-667477.0 |
| 17 | Compressor Drive | 1 | 667560.1 | A-667560.1 |
| 18 | Rotary Screen Fan and Drive | 1 | 667242.0 | A-667242.0 |
| 19 | Alternator Drive Starter | 1 | 667673.0 | A-667673.0 |
| 20 | Agitator Drive (rear) | 1 | 667973.0 | A-667973.0 |
| 21 | Agitator Drive (front) | 1 | 667974.0 | A-667974.0 |
| 22 | Rotary Screen Drive | 1 | 667561.1 | A-667561.1 |
| 23 | Threshing Drum Variator Drive | 1 | 667248.0 | A-667248.0 |
| 24 | Threshing Drum Variator Drive | 1 | 667458.0 | A-667458.0 |
| 25 | Fan Drive - 1st Stage | 1 | 742026.0 | A-742026.0 |
| 26 | Fan Drive - 1st Stage | 1 | 667457.0 | A-667457.0 |
| 27 | Speed Reducing Gear Box | 1 | 667251.0 | A-667251.0 |

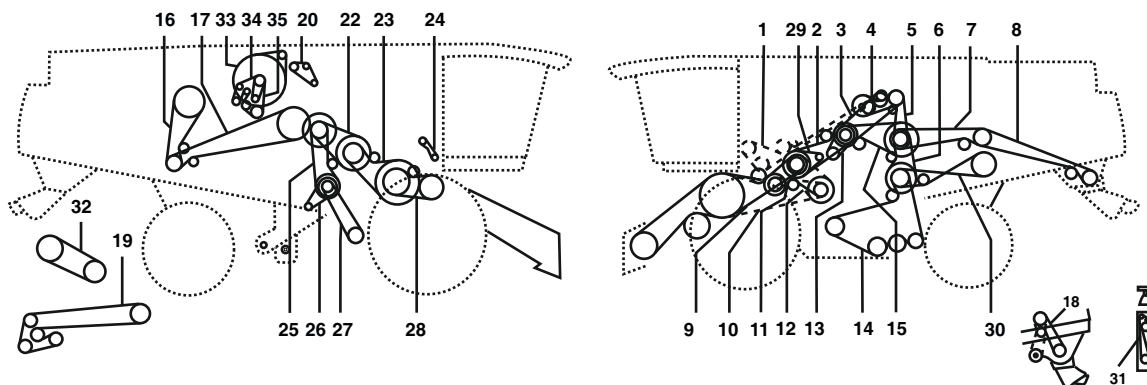

CLAAS LEXION 430 II

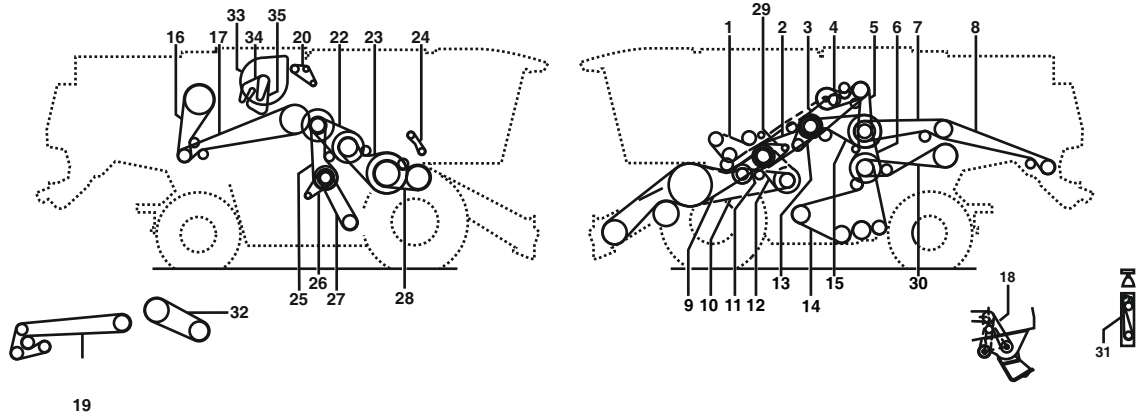

| Belt No. |  | No. of Belts | OEM  Part No. | PIX  Part No. |
|----------|---|--------------|--|--|
| 2 | Cutterbar Drive, 1ste Stage | 1 | 667255.0 | A-667255.0 |
| 3 | Threshing Mechanism Drive | 1 | 352371.1 | A-352371.1 |
| 4 | Grain Tank Unloading | 1 | 667250.0 | A-667250.0 |
| 5 | Chopper Drive 1ste Stage | 1 | 667958.3 | A-667958.3 |
| 6 | Sieve Pan, 2nd Stage | 1 | 667252.0 | A-667252.0 |
| 7 | Chopper Drive, 2nd Stage | 1 | 667683.1 | A-667683.1 |
| 8 | Chopper Drive, 3rd Stage Adjustable Chopper | 1 | 667683.1 | A-667683.1 |
| 8 | Chopper Drive, 3rd Stage Rigid Chopper | 1 | 061701.2 | A-061701.2 |
| 9 | Cutterbar Drive, 2nd Stage Without Variable Speed Drive | 2 | 667454.0 | A-667454.0 |
| 10 | Cutterbar Drive, 2nd Stage With Variable Speed Drive | 2 | 667551.1 | A-667551.1 |
| 11 | Synchronous Drive | 1 | 667249.0 | A-667249.0 |
| 12 | Cutterbar Variator | 1 | 667530.1 | A-667530.1 |
| 13 | Chaff Spreader | 1 | 758719.0 | A-758719.0 |
| 14 | Cleaning, 3rd Stage | 1 | 667651.0 | A-667651.0 |
| 15 | Cleaning, 1st Stage | 1 | 644209.0 | A-644209.0 |
| 16 | Intensive Separation System, Short | 1 | 667973.0 | A-667973.0 |
| 17 | Intensive Separation System, Long | 1 | 667974.0 | A-667974.0 |
| 18 | Chopper Drive, 4th Stage | 1 | 667684.0 | A-667684.0 |
| 19 | Finger Roller | 1 | 509035.1 | A-509035.1 |
| 22 | Drum Variator | 1 | 667248.0 | A-667248.0 |
| 23 | Drum Drive | 1 | 176442.1 | A-176442.1 |
| 25 | Fan Drive | 1 | 742026.0 | A-742026.0 |
| 26 | Suction Blower Lexion 430, 420 | 1 | 644781.0 | A-644781.0 |
| 27 | Fan Variator | 1 | 667457.0 | A-667457.0 |
| 28 | Pre - Drum Drive | 1 | 667251.1 | A-667251.1 |
| 29 | Hydraulic Reel Drive | 1 | 829094.0 | A-829094.0 |
| 30 | Straw Walker Drive | 1 | 667477.0 | A-667477.0 |
| 31 | Straw Spreader | 1 | 539443.0 | A-539443.0 |
| 32 | Drum Variator 2nd Stage | 1 | 667248.0 | A-667248.0 |
| 33 | Radiator Screen 2nd Stage | 1 | 545689.0 | A-545689.0 |
| 35 | Fan Drive | 1 | 796450.0 | A-796450.0 |





19

| Belt No. |  | No. of Belts | OEM  Part No. | PIX  Part No. |
|----------|---|--------------|--|--|
| 2 | | 1 | 667255.0 | A-667255.0 |
| 3 | | 1 | 352371.1 | A-352371.1 |
| 4 | | 1 | 667250.0 | A-667250.0 |
| 5 | | 1 | 667958.3 | A-667958.3 |
| 6 | | 1 | 667252.0 | A-667252.0 |
| 7 | | 1 | 667683.1 | A-667683.1 |
| 8 | | 1 | 667683.1 | A-667683.1 |
| 9 | | 2 | 667454.0 | A-667454.0 |
| 10 | | 2 | 667551.1 | A-667551.1 |
| 11 | | 1 | 667249.0 | A-667249.0 |
| 12 | | 1 | 667530.0 | A-667530.0 |
| 13 | | 1 | 758719.0 | A-758719.0 |
| 14 | | 1 | 667651.0 | A-667651.0 |
| 15 | | 1 | 644209.0 | A-644209.0 |
| 16 | | 1 | 667973.0 | A-667973.0 |
| 17 | | 1 | 667974.0 | A-667974.0 |
| 18 | | 1 | 667684.0 | A-667684.0 |
| 19 | | 1 | 509035.1 | A-509035.1 |
| 22 | | 1 | 667248.0 | A-667248.0 |
| 23 | | 1 | 176442.1 | A-176442.1 |
| 25 | | 1 | 742026.0 | A-742026.0 |
| 26 | | 1 | 644781.0 | A-644781.0 |
| 27 | | 1 | 667457.0 | A-667457.0 |
| 28 | | 1 | 667251.1 | A-667251.1 |
| 29 | | 1 | 829094.0 | A-829094.0 |
| 30 | | 1 | 667477.0 | A-667477.0 |
| 31 | | 1 | 539443.0 | A-539443.0 |
| 32 | | 1 | 667248.0 | A-667248.0 |
| 33 | | 1 | 545689.0 | A-545689.0 |
| 35 | | 1 | 796450.0 | A-796450.0 |

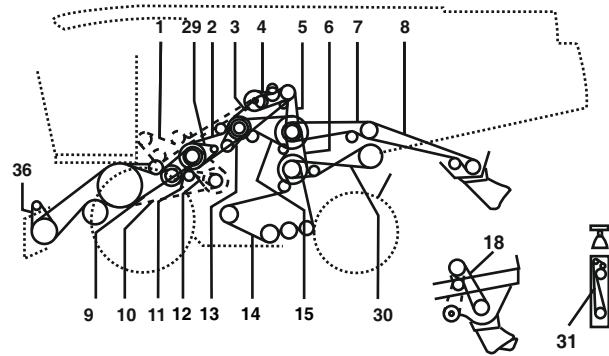
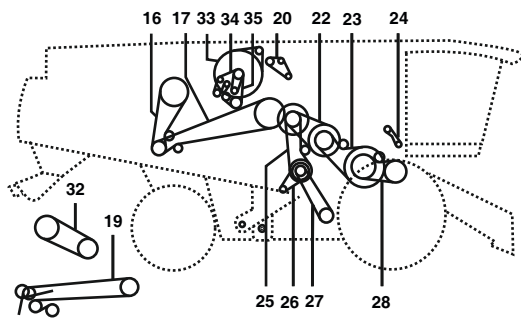
CLAAS LEXION 440 II



| Belt No. |  | No. of Belts | OEM  Part No. | PIX  Part No. |
|----------|---|--------------|--|--|
| 2 | Cutterbar Drive, 1ste Stage | 1 | 667255.0 | A-667255.0 |
| 3 | Threshing Mechanism Drive | 1 | 667453.0 | A-667453.0 |
| 4 | Grain Tank Unloading | 1 | 667250.0 | A-667250.0 |
| 5 | Chopper Drive 1ste Stage | 1 | 667958.3 | A-667958.3 |
| 6 | Sieve Pan, 2nd Stage | 1 | 667252.0 | A-667252.0 |
| 7 | Chopper Drive, 2nd Stage | 1 | 061700.1 | A-061700.1 |
| 8 | Chopper Drive, 3rd Stage Adjustable Chopper | 1 | 061700.1 | A-061700.1 |
| 8 | Chopper Drive, 3rd Stage Rigid Chopper From No. 54402246 | 1 | 749828.0 | A-749828.0 |
| 8 | No. 54401896 - 54402245 | 1 | 628888.0 | A-628888.0 |
| 8 | To No. 54401895 | 1 | 749828.0 | A-749828.0 |
| 9 | Cutterbar Drive, 2nd Stage Without Variable Speed Drive | 2 | 667454.0 | A-667454.0 |
| 10 | Cutterbar Drive, 3rd Stage With Variable Speed Drive | 2 | 667551.1 | A-667551.1 |
| 11 | Synchronous Drive | 1 | 667249.0 | A-667249.0 |
| 12 | Cutterbar Variator | 1 | 667530.1 | A-667530.1 |
| 13 | Chaff Spreader | 1 | 758719.0 | A-758719.0 |
| 14 | Cleaning, 3rd Stage | 1 | 667651.0 | A-667651.0 |
| 15 | Cleaning, 1st Stage | 1 | 644209.0 | A-644209.0 |
| 16 | Intensive Separation System, Short | 1 | 667973.0 | A-667973.0 |
| 17 | Intensive Separation System, Long | 1 | 667974.0 | A-667974.0 |
| 18 | Chopper Drive, 4th Stage | 1 | 661093.0 | A-661093.0 |
| 19 | Finger Roller | 1 | 509035.1 | A-509035.1 |
| 22 | Drum Variator | 1 | 667248.0 | A-667248.0 |
| 23 | Drum Drive | 1 | 176442.1 | A-176442.1 |
| 25 | Fan Drive | 1 | 742026.0 | A-742026.0 |
| 26 | Suction Fan | 1 | 644781.0 | A-644781.0 |
| 27 | Fan Variator | 1 | 667457.0 | A-667457.0 |
| 28 | Pre - Drum Drive | 1 | 667251.1 | A-667251.1 |
| 29 | Hydraulic Reel Drive | 1 | 829094.0 | A-829094.0 |
| 30 | Straw Walker Drive | 1 | 667477.0 | A-667477.0 |
| 31 | Straw Spreader | 1 | 539443.0 | A-539443.0 |
| 32 | Drum Variator 2nd Stage | 1 | 667248.0 | A-667248.0 |
| 33 | Radiator Screen 2nd Stage | 1 | 545689.0 | A-545689.0 |
| 34 | Engine C9 | 1 | 796474.0 | A-796474.0 |
| 35 | Fan Drive | 1 | 796450.0 | A-796450.0 |
| 36 | Suction Blower E - Channel | 1 | 765985.0 | A-765985.0 |

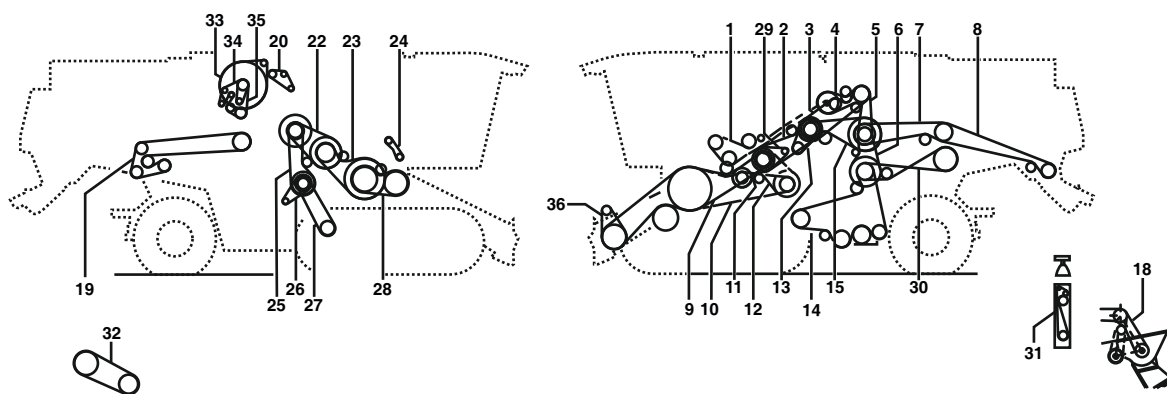

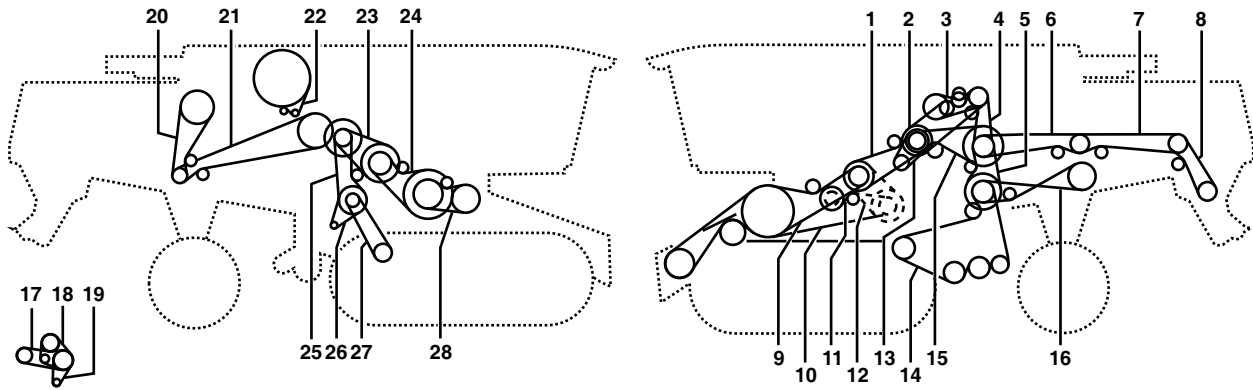

| Belt No. |  | No. of Belts | OEM  Part No. | PIX  Part No. |
|----------|---|--------------|--|--|
| 2 | Cutterbar Drive, 1ste Stage | 1 | 667255.0 | A-667255.0 |
| 3 | Threshing Mechanism Drive | 1 | 352403.0 | A-352403.0 |
| 4 | Grain Tank Unloading | 1 | 667250.0 | A-667250.0 |
| 5 | Chopper Drive 1ste Stage | 1 | 667958.3 | A-667958.3 |
| 6 | Sieve Pan 2nd Stage | 1 | 667252.0 | A-667252.0 |
| 7 | Chopper Drive, 2nd Stage | 1 | 061700.1 | A-061700.1 |
| 8 | Chopper Drive, 3rd Stage Adjustable Chopper | 1 | 061700.1 | A-061700.1 |
| 8 | Chopper Drive, 3rd Stage Rigid Chopper | 1 | 749828.0 | A-749828.0 |
| | From No. 54700050 | | | |
| 8 | No. 54700041 - 54700049 | 1 | 628888.0 | A-628888.0 |
| 8 | To No. 54700040 | 1 | 749828.0 | A-749828.0 |
| 9 | Cutterbar Drive, 2nd Stage W/o Variable Speed Drive | 2 | 667454.0 | A-667454.0 |
| 10 | Cutterbar Drive, 3rd Stage With Variable Speed Drive | 2 | 667551.1 | A-667551.1 |
| 11 | Synchronous Drive | 1 | 667249.0 | A-667249.0 |
| 12 | Cutterbar Variator | 1 | 667530.1 | A-667530.1 |
| 13 | Chaff Spreader | 1 | 758719.0 | A-758719.0 |
| 14 | Cleaning, 3rd Stage | 1 | 667651.0 | A-667651.0 |
| 15 | Cleaning, 1ste Stage | 1 | 644209.0 | A-644209.0 |
| 18 | Chopper Drive, 4th Stage | 1 | 661093.0 | A-661093.0 |
| 19 | Finger Roller | 1 | 509035.1 | A-509035.1 |
| 22 | Drum Variator | 1 | 667248.0 | A-667248.0 |
| 23 | Drum Drive | 1 | 176442.1 | A-176442.1 |
| 25 | Fan Drive | 1 | 742026.0 | A-742026.0 |
| 26 | Suction Fan | 1 | 644781.0 | A-644781.0 |
| 27 | Fan Variator | 1 | 667457.0 | A-667457.0 |
| 28 | Pre - Drum Drive | 1 | 667251.1 | A-667251.1 |
| 29 | Hydraulic Reel Drive | 1 | 829094.0 | A-829094.0 |
| 30 | Straw Walker Drive | 1 | 667477.0 | A-667477.0 |
| 31 | Straw Spreader | 1 | 539443.0 | A-539443.0 |
| 32 | Drum Variator 2nd Stage | 1 | 667248.0 | A-667248.0 |
| 33 | Radiator Screen 2nd Stage | 1 | 545689.0 | A-545689.0 |
| 34 | Engine C9 | 1 | 796474.0 | A-796474.0 |
| 35 | Fan Drive | 1 | 796450.0 | A-796450.0 |
| 36 | Suction Blower E - Channel | 1 | 765985.0 | A-765985.0 |

CLAAS LEXION 450 TERRA

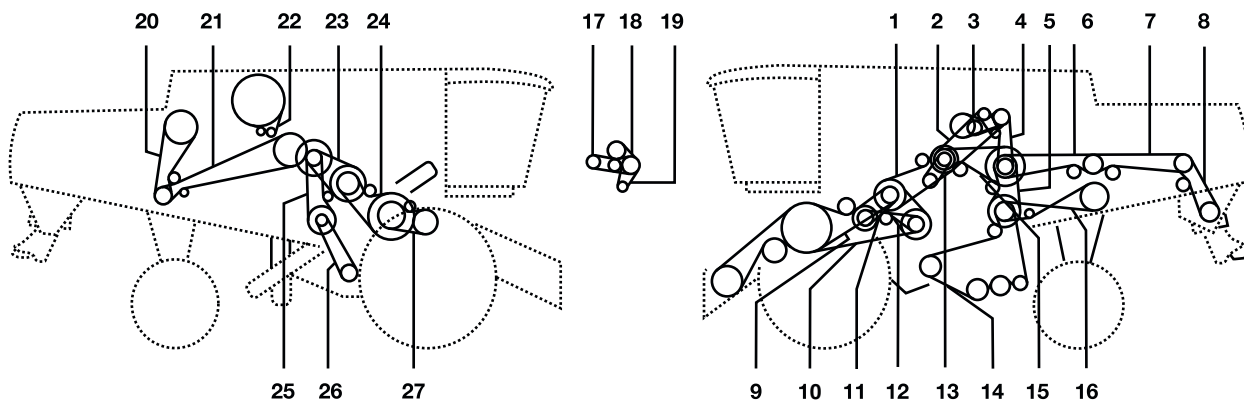

| Belt No. | | No. of Belts | OEM Part No. | PIX Part No. |
|----------|--|--------------|---------------|---------------|
| 1 | 1ste Stage Cutterbar | 1 | 667255.0 | A-667255.0 |
| 2 | Threshing Mechanism | 1 | 667453.0 | A-667453.0 |
| 3 | Grain Tank Unloading | 1 | 667250.0 | A-667250.0 |
| 4 | 1ste Stage Chopper | 1 | 667958.3 | A-667958.3 |
| 5 | 2nd Stage Cleaning | 1 | 667252.0 | A-667252.0 |
| 6 | 2nd Stage Chopper | 1 | 061700.1 | A-061700.1 |
| 7 | 3rd Stage Chopper | 1 | 061700.1 | A-061700.1 |
| 8 | 4th Stage Chopper | 1 | 661093.0 | A-661093.0 |
| 9 | 2nd Stage Cutterbar Without Variable Speed | 2 | 667454.0 | A-667454.0 |
| 10 | 3rd Stage Cutterbar With Variable Speed | 2 | 667551.1 | A-667551.1 |
| 11 | Impeller Drum | 1 | 667249.0 | A-667249.0 |
| 12 | Cutterbar Variable Speed | 1 | 667530.0 | A-667530.0 |
| 13 | Hydraulic Pump | 1 | 758719.0 | A-758719.0 |
| 14 | 3rd Stage Cleaning | 1 | 667651.0 | A-667651.0 |
| 15 | 1ste Stage Cleaning | 1 | 644209.0 | A-644209.0 |
| 16 | Straw Walker | 1 | 667477.0 | A-667477.0 |
| 17 | Compressor | 1 | 667560.1 | A-667560.1 |
| 18 | Motor Fan | 1 | 667242.0 | A-667242.0 |
| 19 | 1ste Stage Radiator Screen | 1 | 667456.0 | A-667456.0 |
| 20 | Rear Feed Rake | 1 | 667973.0 | A-667973.0 |
| 21 | Front Feed Rake | 1 | 667974.0 | A-667974.0 |
| 22 | 2nd Stage Radiator Screen | 1 | 667561.1 | A-667561.1 |
| 23 | Drum Variable Speed Drive | 1 | 667248.0 | A-667248.0 |
| 24 | Threshing Drum From No. 45800017 | 1 | 176442.1 | A-176442.1 |
| 24 | Threshing Drum To No. 45700016 | 1 | 667458.0 | A-667458.0 |
| 24 | Threshing Drum At Disc D 593 Mm Optional | 1 | 667255.0 | A-667255.0 |
| 25 | 1ste Stage Blower | 1 | 742026.0 | A-742026.0 |
| 26 | Fan Variable Speed Drive | 1 | 667457.0 | A-667457.0 |
| 27 | Accelerator | 1 | 667251.1 | A-667251.1 |
| 28 | Suction Fan | 1 | 644781.0 | A-644781.0 |

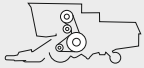

| Belt No. |  | No. of Belts | OEM  Part No. | PIX  Part No. |
|----------|---|--------------|--|--|
| 0 | Reel Drive Variable Speed | 1 | 670244.1 | A-670244.1 |
| 0 | Knife Drive | 1 | 742025.0 | A-742025.0 |
| 1 | Clutch Forcutterbar Drive | 1 | 667255.0 | A-667255.0 |
| 2 | Threshing Mechanism Drive | 1 | 667453.0 | A-667453.0 |
| 3 | Discharge Drive Grain Tank | 1 | 667250.0 | A-667250.0 |
| 4 | Straw Chopper Drive - 1st Stage | 1 | 667958.2 | A-667958.2 |
| 5 | Sieve Pan Drive - 2nd Stage | 1 | 667252.0 | A-667252.0 |
| 6 | Straw Chopper Drive - 2nd Stage | 1 | 061700.1 | A-061700.1 |
| 7 | Straw Chopper Drive - 2nd Stage | 1 | 061700.1 | A-061700.1 |
| 8 | Straw Chopper Drive - 4th Stage | 1 | 661093.0 | A-661093.0 |
| 9 | Cutterbar Drive Without Variator Drive | 2 | 667454.0 | A-667454.0 |
| 10 | Cutterbar Drive With Variable Speed Drive | 2 | 667551.0 | A-667551.0 |
| 11 | Impeller Drum Drive | 1 | 667249.0 | A-667249.0 |
| 12 | Cutterbar Drive With Variable Speed Drive | 1 | 667530.0 | A-667530.0 |
| 13 | Hydraulic Pump Drive | 1 | 758719.0 | A-758719.0 |
| 14 | Sieve Pan Drive 2nd Stage | 1 | 667651.0 | A-667651.0 |
| 15 | Sieve Pan Drive - 1st Stage | 1 | 644209.0 | A-644209.0 |
| 16 | Straw Walker Drive | 1 | 667477.0 | A-667477.0 |
| 17 | Compressor Drive | 1 | 667560.1 | A-667560.1 |
| 18 | Rotary Screen Fan and Drive | 1 | 667242.0 | A-667242.0 |
| 19 | Rotary Screen Drive | 1 | 667456.0 | A-667456.0 |
| 20 | Agitator Drive (rear) | 1 | 667973.0 | A-667973.0 |
| 21 | Agitator Drive (front) | 1 | 667974.0 | A-667974.0 |
| 22 | Rotary Screen Drive | 1 | 667561.1 | A-667561.1 |
| 23 | Threshing Drum Variator Drive | 1 | 667248.0 | A-667248.0 |
| 24 | Threshing Drum Variator Drive | 1 | 667458.0 | A-667458.0 |
| 25 | Fan Drive - 1st Stage | 1 | 742026.0 | A-742026.0 |
| 26 | Fan Intermediate Drive | 1 | 667457.0 | A-667457.0 |
| 27 | Speed Reducing Gear Box | 1 | 667251.0 | A-667251.0 |

CLAAS LEXION 460 II

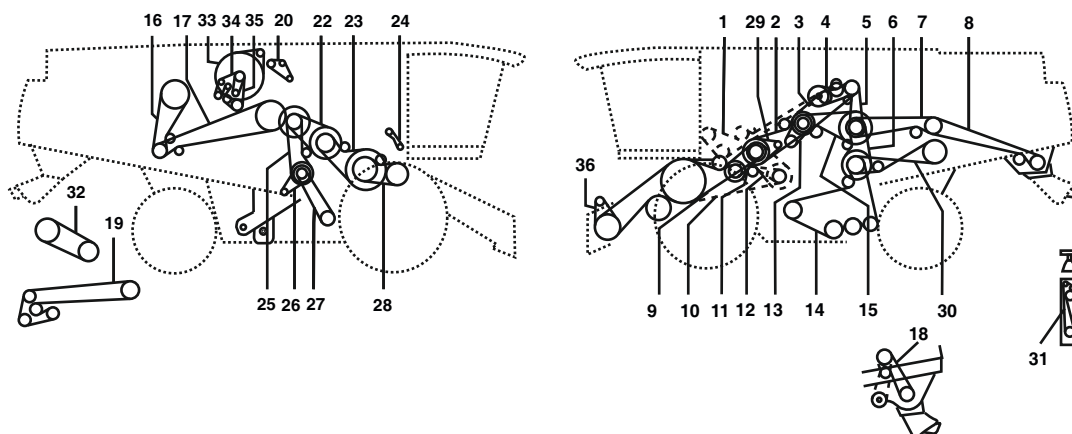

| Belt No. |  | No. of Belts | OEM  Part No. | PIX  Part No. |
|----------|---|--------------|--|--|
| 2 | Cutterbar Drive, 1ste Stage | 1 | 667255.0 | A-667255.0 |
| 3 | Threshing Mechanism Drive | 1 | 352403.0 | A-352403.0 |
| 4 | Grain Tank Unloading | 1 | 667250.0 | A-667250.0 |
| 5 | Chopper Drive 1ste Stage | 1 | 667958.3 | A-667958.3 |
| 6 | Sieve Pan, 2nd Stage | 1 | 667252.0 | A-667252.0 |
| 7 | Chopper Drive, 2nd Stage | 1 | 061700.1 | A-061700.1 |
| 8 | Chopper Drive, 3rd Stage Adjustable Chopper | 1 | 061700.1 | A-061700.1 |
| 8 | Chopper Drive, 3rd Stage Rigid Chopper From No. 54402246 | 1 | 749828.0 | A-749828.0 |
| 8 | No. 54401896 - 54402245 | 1 | 628888.0 | A-628888.0 |
| 8 | To No. 54401895 | 1 | 749828.0 | A-749828.0 |
| 9 | Cutterbar Drive, 2nd Stage W/o Variable Speed Drive | 2 | 667454.0 | A-667454.0 |
| 10 | Cutterbar Drive, 3rd Stage With Variable Speed Drive | 2 | 667551.1 | A-667551.1 |
| 11 | Synchronous Drive | 1 | 667249.0 | A-667249.0 |
| 12 | Cutterbar Variator | 1 | 667530.1 | A-667530.1 |
| 13 | Chaff Spreader | 1 | 758719.0 | A-758719.0 |
| 14 | Cleaning, 3rd Stage | 1 | 667651.0 | A-667651.0 |
| 15 | Cleaning, 1st Stage | 1 | 644209.0 | A-644209.0 |
| 16 | Intensive Separation System, Short | 1 | 667973.0 | A-667973.0 |
| 17 | Intensive Separation System, Long | 1 | 667974.0 | A-667974.0 |
| 18 | Chopper Drive, 4th Stage | 1 | 661093.0 | A-661093.0 |
| 19 | Finger Roller | 1 | 509035.1 | A-509035.1 |
| 22 | Drum Variator | 1 | 667248.0 | A-667248.0 |
| 23 | Drum Drive | 1 | 176442.1 | A-176442.1 |
| 25 | Fan Drive | 1 | 742026.0 | A-742026.0 |
| 26 | Suction Fan | 1 | 644781.0 | A-644781.0 |
| 27 | Fan Variator | 1 | 667457.0 | A-667457.0 |
| 28 | Pre - Drum Drive | 1 | 667251.1 | A-667251.1 |
| 29 | Hydraulic Reel Drive | 1 | 829094.0 | A-829094.0 |
| 30 | Straw Walker Drive | 1 | 667477.0 | A-667477.0 |
| 31 | Straw Spreader | 1 | 539443.0 | A-539443.0 |
| 32 | Drum Variator 2nd Stage | 1 | 667248.0 | A-667248.0 |
| 33 | Radiator Screen 2nd Stage | 1 | 545689.0 | A-545689.0 |
| 34 | Engine C9 | 1 | 796474.0 | A-796474.0 |
| 35 | Fan Drive | 1 | 796450.0 | A-796450.0 |
| 36 | Suction Blower E - Channel | 1 | 765985.0 | A-765985.0 |

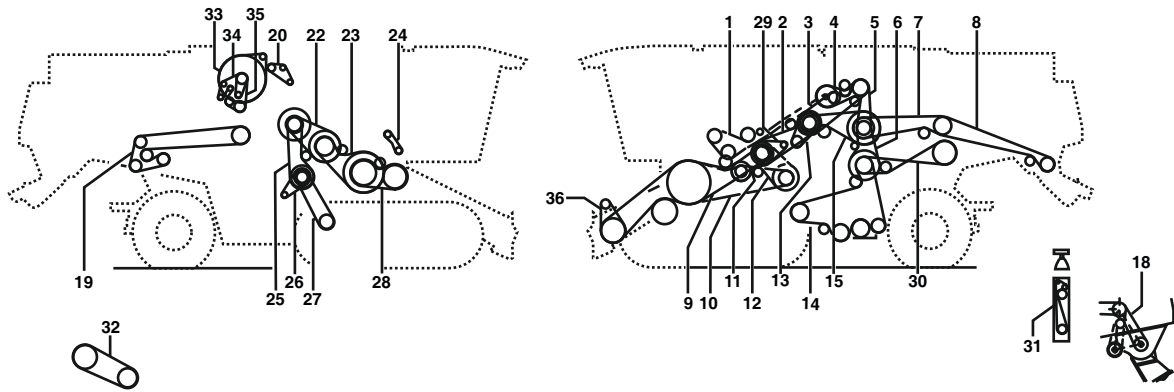

CLAAS LEXION 460 II MTS





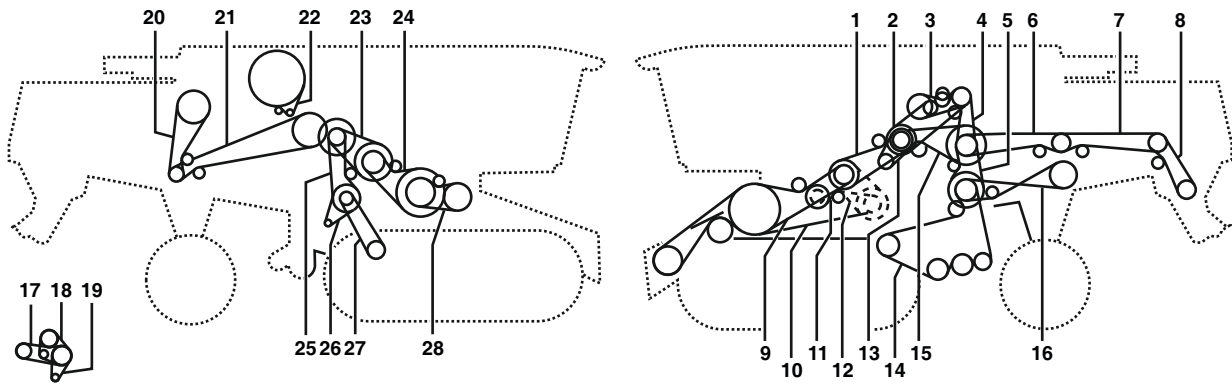

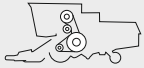
| Belt No. | | No. of Belts | OEM Part No. | PIX Part No. |
|----------|-------------------------|--------------|---------------|---------------|
| 2 | | 1 | 667255.0 | A-667255.0 |
| 3 | | 1 | 352403.0 | A-352403.0 |
| 4 | | 1 | 667250.0 | A-667250.0 |
| 5 | | 1 | 667958.3 | A-667958.3 |
| 6 | | 1 | 667252.0 | A-667252.0 |
| 7 | | 1 | 061700.1 | A-061700.1 |
| 8 | | 1 | 061700.1 | A-061700.1 |
| 8 | | 1 | 749828.0 | A-749828.0 |
| | From No. 54700050 | | | |
| 8 | No. 54700041 - 54700049 | 1 | 628888.0 | A-628888.0 |
| 8 | To No. 54700040 | 1 | 749828.0 | A-749828.0 |
| 9 | | 2 | 667454.0 | A-667454.0 |
| 10 | | 2 | 667551.1 | A-667551.1 |
| 11 | | 1 | 667249.0 | A-667249.0 |
| 12 | | 1 | 667530.1 | A-667530.1 |
| 13 | | 1 | 758719.0 | A-758719.0 |
| 14 | | 1 | 667651.0 | A-667651.0 |
| 15 | | 1 | 644209.0 | A-644209.0 |
| 18 | | 1 | 661093.0 | A-661093.0 |
| 19 | | 1 | 509035.1 | A-509035.1 |
| 22 | | 1 | 667248.0 | A-667248.0 |
| 23 | | 1 | 176442.1 | A-176442.1 |
| 25 | | 1 | 742026.0 | A-742026.0 |
| 26 | | 1 | 644781.0 | A-644781.0 |
| 27 | | 1 | 667457.0 | A-667457.0 |
| 28 | | 1 | 667251.1 | A-667251.1 |
| 29 | | 1 | 829094.0 | A-829094.0 |
| 30 | | 1 | 667477.0 | A-667477.0 |
| 31 | | 1 | 539443.0 | A-539443.0 |
| 32 | | 1 | 667248.0 | A-667248.0 |
| 33 | | 1 | 545689.0 | A-545689.0 |
| 34 | | 1 | 796474.0 | A-796474.0 |
| 35 | | 1 | 796450.0 | A-796450.0 |
| 36 | | 1 | 765985.0 | A-765985.0 |

CLAAS LEXION 460 TERRA

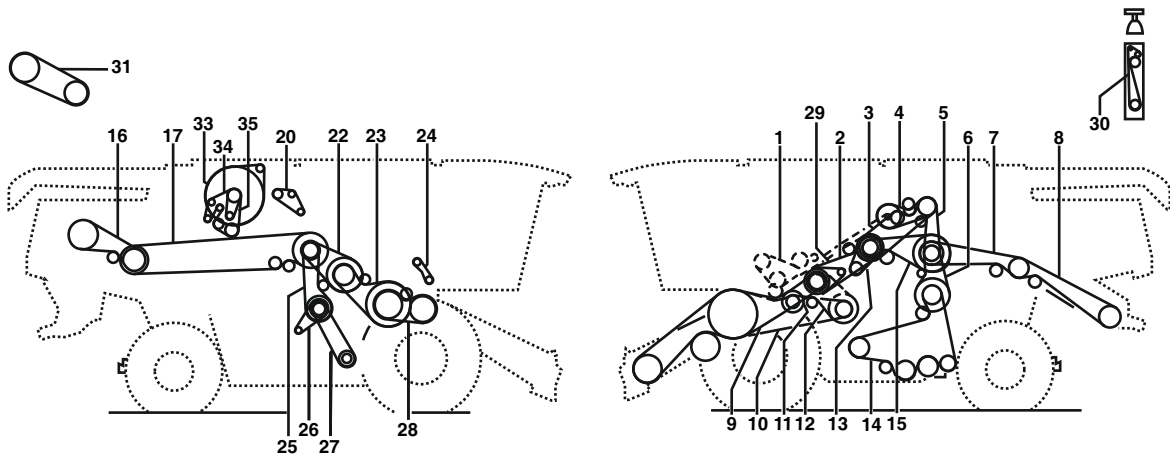





| Belt No. |  | No. of Belts | OEM  Part No. | PIX  Part No. |
|----------|---|--------------|--|--|
| 1 | 1st Stage Cutterbar | 1 | 667255.0 | A-667255.0 |
| 2 | Threshing Mechanism | 1 | 667453.0 | A-667453.0 |
| 3 | Grain Tank Unloading | 1 | 667250.0 | A-667250.0 |
| 4 | 1st Stage Chopper | 1 | 667958.3 | A-667958.3 |
| 5 | 2nd Stage Cleaning | 1 | 667252.0 | A-667252.0 |
| 6 | 2nd Stage Chopper | 1 | 061700.1 | A-061700.1 |
| 7 | 3rd Stage Chopper | 1 | 061700.1 | A-061700.1 |
| 8 | 4th Stage Chopper | 1 | 661093.0 | A-661093.0 |
| 9 | 2nd Stage Cutterbar Without Variable Speed | 2 | 667454.0 | A-667454.0 |
| 10 | 3rd Stage Cutterbar With Variable Speed | 2 | 667551.1 | A-667551.1 |
| 11 | Impeller Drum | 1 | 667249.0 | A-667249.0 |
| 12 | Cutterbar Variable Speed | 1 | 667530.0 | A-667530.0 |
| 13 | Hydraulic Pump | 1 | 758719.0 | A-758719.0 |
| 14 | 3rd Stage Cleaning | 1 | 667651.0 | A-667651.0 |
| 15 | 1st Stage Cleaning | 1 | 644209.0 | A-644209.0 |
| 16 | Straw Walker | 1 | 667477.0 | A-667477.0 |
| 17 | Compressor | 1 | 667560.1 | A-667560.1 |
| 18 | Motor Fan | 1 | 667242.0 | A-667242.0 |
| 19 | 1st Stage Radiator Screen | 1 | 667456.0 | A-667456.0 |
| 20 | Rear Feed Rake | 1 | 667973.0 | A-667973.0 |
| 21 | Front Feed Rake | 1 | 667974.0 | A-667974.0 |
| 22 | 2nd Stage Radiator Screen | 1 | 667561.1 | A-667561.1 |
| 23 | Drum Variable Speed Drive | 1 | 667248.0 | A-667248.0 |
| 24 | Threshing Drum From No. 45800017 | 1 | 176442.1 | A-176442.1 |
| 24 | Threshing Drum To No. 45700016 | 1 | 667458.0 | A-667458.0 |
| 24 | Threshing Drum At Disc D 593 Mm Optional | 1 | 667255.0 | A-667255.0 |
| 25 | 1st Stage Blower | 1 | 742026.0 | A-742026.0 |
| 26 | Fan Variable Speed Drive | 1 | 667457.0 | A-667457.0 |
| 27 | Accelerator | 1 | 667251.1 | A-667251.1 |
| 28 | Suction Fan | 1 | 644781.0 | A-644781.0 |



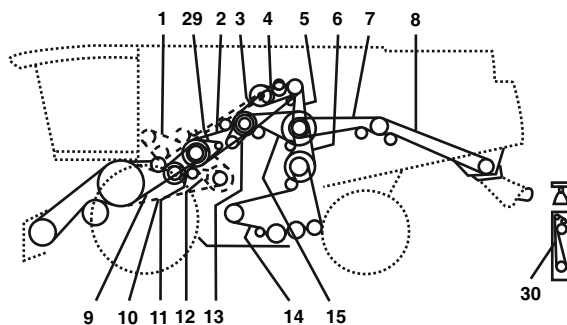
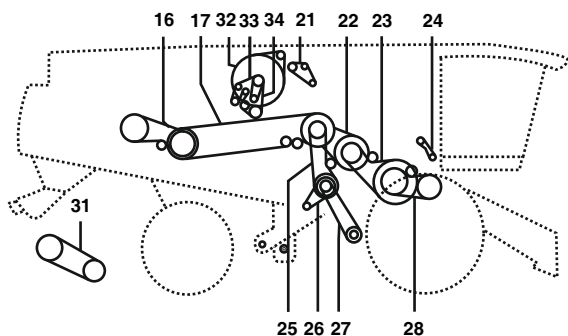



| Belt No. |  | No. of Belts | OEM  Part No. | PIX  Part No. |
|----------|---|--------------|--|--|
| 2 | Cutterbar Drive, 1ste Stage | 1 | 667255.0 | A-667255.0 |
| 3 | Threshing Mechanism Drive | 1 | 352403.0 | A-352403.0 |
| 4 | Discharge Drive Grain Tank | 1 | 667250.0 | A-667250.0 |
| 5 | Chopper Drive - 1st Stage | 1 | 667958.3 | A-667958.3 |
| 6 | Sieve Pan Drive - 2nd Stage | 1 | 667252.0 | A-667252.0 |
| 7 | Chopper Drive - 2nd Stage | 1 | 061700.1 | A-061700.1 |
| 8 | Chopper Drive - 3rd Stage | 1 | 350463.0 | A-350463.0 |
| 9 | Cutterbar Drive, 2nd Stage Without Vari. Speed Drive | 2 | 667454.0 | A-667454.0 |
| 10 | Cutterbar Drive, 3rd Stage With Variable Speed Drive | 2 | 667551.1 | A-667551.1 |
| 11 | Synchronous Drive | 1 | 667249.0 | A-667249.0 |
| 12 | Cutterbar Drive With Variable Speed Drive | 1 | 667530.1 | A-667530.1 |
| 13 | Chaff Spreader Drive | 1 | 758719.0 | A-758719.0 |
| 14 | Cleaning - 3rd Stage | 1 | 667651.0 | A-667651.0 |
| 15 | Cleaning - 1st Stage | 1 | 644209.0 | A-644209.0 |
| 16 | Hybrid Drive - 2nd Stage | 1 | 629510.1 | A-629510.1 |
| 17 | Hybrid Drive - 1st Stage | 1 | 749886.1 | A-749886.1 |
| 22 | Drum Drive Variable Speed | 1 | 667248.0 | A-667248.0 |
| 23 | Drum Drive | 1 | 176442.1 | A-176442.1 |
| 25 | Fan Drive | 1 | 742026.0 | A-742026.0 |
| 26 | Suction Fan | 1 | 644781.0 | A-644781.0 |
| 27 | Fan Drive Variable Speed | 1 | 667457.0 | A-667457.0 |
| 28 | Pre-drum Drive | 1 | 667251.1 | A-667251.1 |
| 29 | Hydraulic Reel Pump Drive | 1 | 829094.0 | A-829094.0 |
| 30 | Straw Spreader Drive | 1 | 539443.0 | A-539443.0 |
| 31 | Hybrid Variable Speed Drive | 1 | 667248.0 | A-667248.0 |
| 32 | Radiator Screen - 2nd Stage | 1 | 545689.0 | A-545689.0 |
| 33 | Engine C9 | 1 | 796474.0 | A-796474.0 |
| 34 | Fan Drive | 1 | 796450.0 | A-796450.0 |

CLAAS LEXION 470 MONTANA

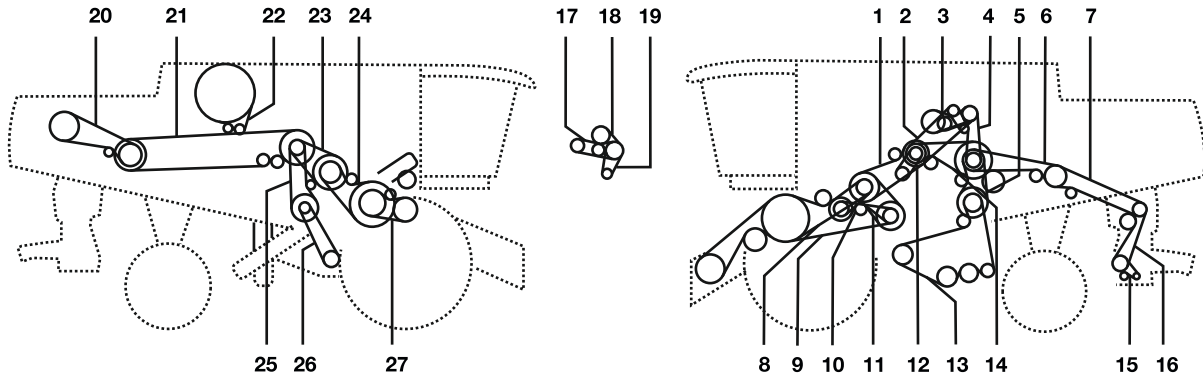





| Belt No. |  | No. of Belts | OEM  Part No. | PIX  Part No. |
|----------|---|--------------|--|--|
| 2 | Cutterbar Drive, 1ste Stage | 1 | 667255.0 | A-667255.0 |
| 3 | Threshing Mechanism Drive | 1 | 352403.0 | A-352403.0 |
| 4 | Grain Tank Unloading | 1 | 667250.0 | A-667250.0 |
| 5 | Chopper Drive 1ste Stage | 1 | 667958.3 | A-667958.3 |
| 6 | Sieve Pan, 2nd Stage | 1 | 667252.0 | A-667252.0 |
| 7 | Chopper Drive, 2nd Stage | 1 | 061700.1 | A-061700.1 |
| 8 | Chopper Drive, 3rd Stage | 1 | 350463.0 | A-350463.0 |
| 9 | Cutterbar Drive, 2nd Stage W/o Variable Speed Drive | 2 | 667454.0 | A-667454.0 |
| 10 | Cutterbar Drive 3rd Stage With Variable Speed Drive | 2 | 667551.1 | A-667551.1 |
| 11 | Synchronous Drive | 1 | 667249.0 | A-667249.0 |
| 12 | Cutterbar Variator | 1 | 667530.0 | A-667530.0 |
| 13 | Chaff Spreader | 1 | 758719.0 | A-758719.0 |
| 14 | Cleaning, 3rd Stage | 1 | 667651.0 | A-667651.0 |
| 15 | Cleaning, 1ste Stage | 1 | 644209.0 | A-644209.0 |
| 16 | Hybrid Drive, 2nd Stage | 1 | 629510.1 | A-629510.1 |
| 17 | Hybrid Drive, 1ste Stage | 1 | 749886.1 | A-749886.1 |
| 22 | Drum Variator | 1 | 667248.0 | A-667248.0 |
| 23 | Drum Drive | 1 | 176442.1 | A-176442.1 |
| 25 | Fan Drive | 1 | 742026.0 | A-742026.0 |
| 26 | Suction Fan | 1 | 644781.0 | A-644781.0 |
| 27 | Fan Variator | 1 | 667457.0 | A-667457.0 |
| 28 | Pre - Drum Drive | 1 | 667251.1 | A-667251.1 |
| 29 | Hydraulic Reel Drive | 1 | 829094.0 | A-829094.0 |
| 30 | Straw Spreader | 1 | 539443.0 | A-539443.0 |
| 31 | Hybrid Variable Speed Drive | 1 | 667248.0 | A-667248.0 |
| 32 | Radiator Screen 2nd Stage | 1 | 545689.0 | A-545689.0 |
| 33 | Engine C9 | 1 | 796474.0 | A-796474.0 |
| 34 | Fan Drive | 1 | 796450.0 | A-796450.0 |



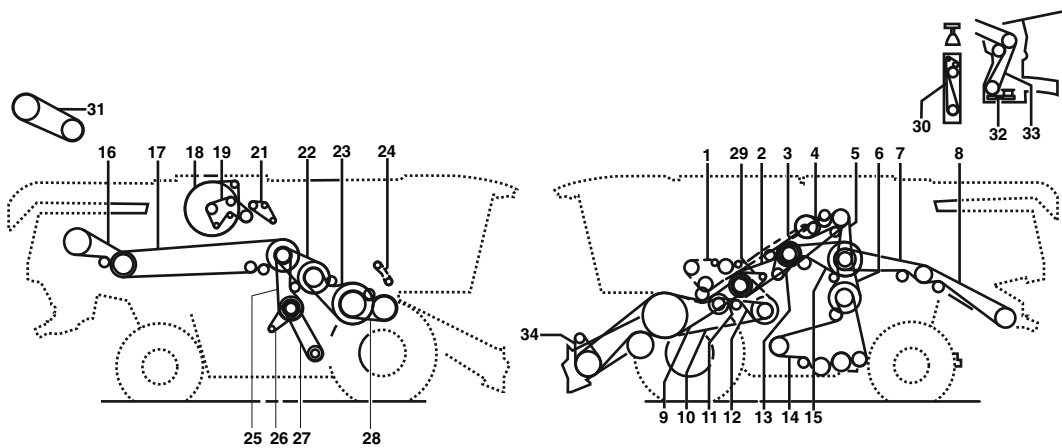

| Belt No. |  | No. of Belts | OEM  Part No. | PIX  Part No. |
|----------|---|--------------|--|--|
| 0 | Reel Drive Variable Speed | 1 | 670244.1 | A-670244.1 |
| 0 | Knife Drive | 1 | 742025.0 | A-742025.0 |
| 1 | Clutch Forcutterbar Drive | 1 | 667255.0 | A-667255.0 |
| 2 | Tensioner For Threshing Mechanical Drive | 1 | 667881.0 | A-667881.0 |
| 3 | Discharge Drive Grain Tank | 1 | 667250.0 | A-667250.0 |
| 4 | Straw Chopper Drive - 1st Stage | 1 | 644685.1 | A-644685.1 |
| 5 | Sieve Pan Drive - 2nd Stage | 1 | 667252.0 | A-667252.0 |
| 6 | Straw Chopper Drive - 2nd Stage | 1 | 061700.1 | A-061700.1 |
| 7 | Straw Chopper Drive - 2nd Stage | 1 | 661298.0 | A-661298.0 |
| 7 | Straw Chopper Drive - 2nd Stage | 1 | 749712.0 | A-749712.0 |
| 8 | Cutterbar Drive Without Variator Drive | 2 | 667454.0 | A-667454.0 |
| 9 | Cutterbar Drive With Variable Speed Drive | 2 | 667551.0 | A-667551.0 |
| 10 | Impeller Drum Drive | 1 | 667249.0 | A-667249.0 |
| 11 | Cutterbar Drive With Variable Speed Drive | 1 | 667530.0 | A-667530.0 |
| 12 | Hydraulic Pump Drive | 1 | 758719.0 | A-758719.0 |
| 12 | Hydraulic Pump Drive | 1 | 233843.1 | A-233843.1 |
| 13 | Sieve Pan Drive 2nd Stage | 1 | 667651.0 | A-667651.0 |
| 14 | Sieve Pan Drive - 1st Stage | 1 | 644209.0 | A-644209.0 |
| 15 | Uni Spreaderdrive - 2nd Stage | 1 | 667891.0 | A-667891.0 |
| 16 | Uni Spreaderdrive - 1st Stage | 1 | 667798.2 | A-667798.2 |
| 17 | Compressor Drive | 1 | 667560.1 | A-667560.1 |
| 18 | Rotary Screen Fan and Drive | 1 | 667242.0 | A-667242.0 |
| 19 | Rotary Screen Drive | 1 | 667456.0 | A-667456.0 |
| 20 | Hybrid Drive - 2nd Stage | 1 | 667427.0 | A-667427.0 |
| 20 | Hybrid Drive - 2nd Stage | 1 | 667983.0 | A-667983.0 |
| 21 | Hybrid Drive - 1st Stage | 1 | 667554.0 | A-667554.0 |
| 22 | Rotary Screen Drive | 1 | 667561.1 | A-667561.1 |
| 23 | Threshing Drum Variator Drive | 1 | 667248.0 | A-667248.0 |
| 24 | Threshing Drum Variator Drive | 1 | 667458.0 | A-667458.0 |
| 25 | Fan Drive - 1st Stage | 1 | 742026.0 | A-742026.0 |
| 26 | Fan Intermediate Drive | 1 | 667457.0 | A-667457.0 |
| 27 | Speed Reducing Gear Box | 1 | 667251.0 | A-667251.0 |

CLAAS LEXION 480 II

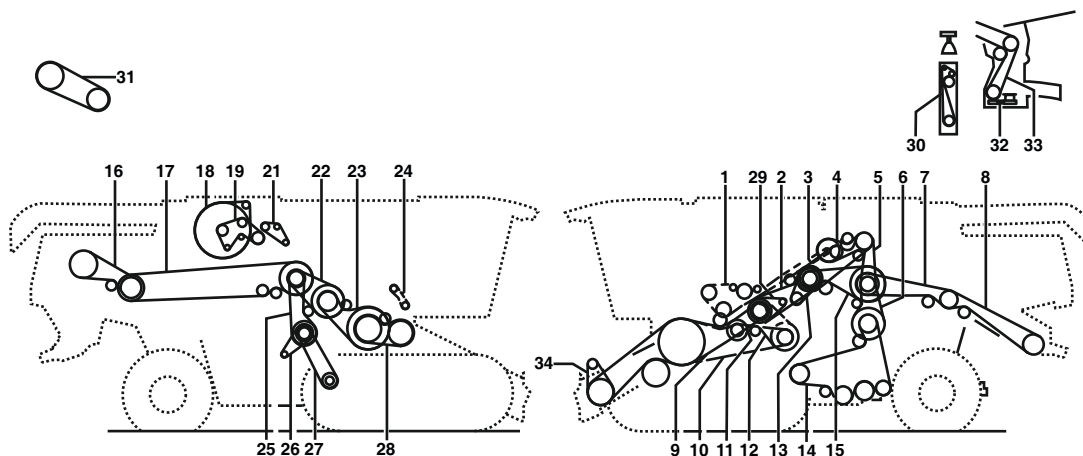

| Belt No. |  | No. of Belts | OEM  Part No. | PIX  Part No. |
|----------|---|--------------|--|--|
| 2 | Cutterbar Drive, 1ste Stage | 1 | 667255.0 | A-667255.0 |
| 3 | Threshing Mechanism Drive | 1 | 667881.0 | A-667881.0 |
| 4 | Grain Tank Unloading | 1 | 667250.0 | A-667250.0 |
| 5 | Chopper Drive 1ste Stage | 1 | 644966.0 | A-644966.0 |
| 6 | Sieve Pan, 2nd Stage | 1 | 667252.0 | A-667252.0 |
| 7 | Chopper Drive, 2nd Stage | 1 | 644889.0 | A-644889.0 |
| 8 | Chopper Drive, 3rd Stage Only For Rice | 1 | 350463.0 | A-350463.0 |
| 8 | Strengthened Drive | 1 | 644890.0 | A-644890.0 |
| 9 | Cutterbar Drive, 2nd Stage Without Vari. Speed Drive | 2 | 667454.0 | A-667454.0 |
| 10 | Cutterbar Drive, 3rd Stage With Variable Speed Drive | 2 | 667551.1 | A-667551.1 |
| 11 | Synchronous Drive | 1 | 667249.0 | A-667249.0 |
| 12 | Cutterbar Variator | 1 | 667530.1 | A-667530.1 |
| 13 | At Chaff Spreader | 1 | 758719.0 | A-758719.0 |
| 13 | At Spreader Fan | 1 | 233843.1 | A-233843.1 |
| 14 | Cleaning, 3rd Stage | 1 | 644866.0 | A-644866.0 |
| 15 | Cleaning, 1ste Stage | 1 | 644209.0 | A-644209.0 |
| 16 | Hybrid Drive, 2nd Stage | 1 | 629510.1 | A-629510.1 |
| 17 | Hybrid Drive, 1ste Stage | 1 | 749886.1 | A-749886.1 |
| 18 | Radiator Screen 2nd Stage | 1 | 545689.0 | A-545689.0 |
| 19 | Fan Drive / C12 | 1 | 761979.1 | A-761979.1 |
| 22 | Drum Variator | 1 | 667248.0 | A-667248.0 |
| 23 | Drum Drive | 1 | 176442.1 | A-176442.1 |
| 25 | Fan Drive | 1 | 742026.0 | A-742026.0 |
| 26 | Suction Fan | 1 | 644781.0 | A-644781.0 |
| 27 | Fan Variator | 1 | 667457.0 | A-667457.0 |
| 28 | Pre - Drum Drive | 1 | 667251.1 | A-667251.1 |
| 29 | Hydraulic Reel Drive | 1 | 829094.0 | A-829094.0 |
| 30 | Straw Spreader | 1 | 539443.0 | A-539443.0 |
| 31 | Hybrid Variable Speed Drive | 1 | 667248.0 | A-667248.0 |
| 32 | Spreader Fan, 2nd Stage | 1 | 667891.1 | A-667891.1 |
| 33 | Spreader Fan, 1ste Stage | 1 | 644942.0 | A-644942.0 |
| 34 | Suction Blower E - Channel | 1 | 765985.0 | A-765985.0 |



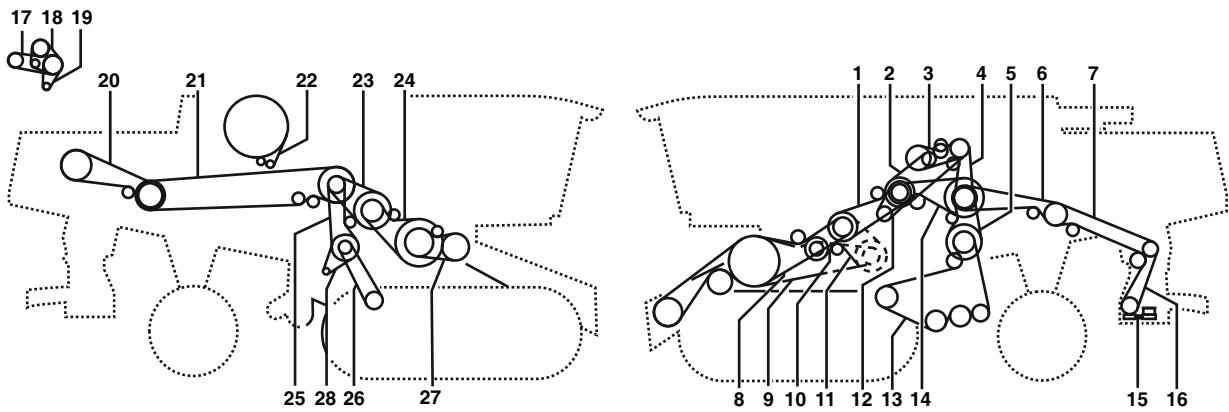

| Belt No. |  | No. of Belts | OEM  Part No. | PIX  Part No. |
|----------|---|--------------|--|--|
| 2 | Cutterbar Drive, 1ste Stage | 1 | 667255.0 | A-667255.0 |
| 3 | Threshing Mechanism Drive | 1 | 667881.0 | A-667881.0 |
| 4 | Grain Tank Unloading | 1 | 667250.0 | A-667250.0 |
| 5 | Chopper Drive, 1ste Stage | 1 | 644966.0 | A-644966.0 |
| 6 | Sieve Pan, 2nd Stage | 1 | 667252.0 | A-667252.0 |
| 7 | Chopper Drive, 2nd Stage | 1 | 644889.0 | A-644889.0 |
| 8 | Chopper Drive, 3rd Stage Only For Rice | 1 | 350463.0 | A-350463.0 |
| 8 | Strengthened Drive | 1 | 644890.0 | A-644890.0 |
| 9 | Cutterbar Drive, 2nd Stage Without Vari. Speed Drive | 2 | 667454.0 | A-667454.0 |
| 10 | Cutterbar Drive 3rd Stage With Variable Speed Drive | 2 | 667551.1 | A-667551.1 |
| 11 | Synchronous Drive | 1 | 667249.0 | A-667249.0 |
| 12 | Cutterbar Variator | 1 | 667530.1 | A-667530.1 |
| 13 | At Chaff Spreader | 1 | 758719.0 | A-758719.0 |
| 13 | At Spreader Fan | 1 | 233843.1 | A-233843.1 |
| 14 | Cleaning, 3rd Stage | 1 | 644866.0 | A-644866.0 |
| 15 | Cleaning, 1ste Stage | 1 | 644209.0 | A-644209.0 |
| 16 | Hybrid Drive, 2nd Stage | 1 | 629510.1 | A-629510.1 |
| 17 | Hybrid Drive, 1ste Stage | 1 | 749886.1 | A-749886.1 |
| 18 | Radiator Screen 2nd Stage | 1 | 545689.0 | A-545689.0 |
| 19 | Fan Drive / C12 | 1 | 761979.1 | A-761979.1 |
| 22 | Drum Variator | 1 | 667248.0 | A-667248.0 |
| 23 | Drum Drive | 1 | 176442.1 | A-176442.1 |
| 25 | Fan Drive | 1 | 742026.0 | A-742026.0 |
| 26 | Suction Fan | 1 | 644781.0 | A-644781.0 |
| 27 | Fan Variator | 1 | 667457.0 | A-667457.0 |
| 28 | Pre - Drum Drive | 1 | 667251.1 | A-667251.1 |
| 29 | Hydraulic Reel Drive | 1 | 829094.0 | A-829094.0 |
| 30 | Straw Spreader | 1 | 539443.0 | A-539443.0 |
| 31 | Hybrid Variable Speed Drive | 1 | 667248.0 | A-667248.0 |
| 32 | Spreader Fan, 2nd Stage | 1 | 667891.1 | A-667891.1 |
| 33 | Spreader Fan, 1ste Stage | 1 | 644942.0 | A-644942.0 |
| 34 | Suction Blower E - Channel | 1 | 765985.0 | A-765985.0 |

CLAAS LEXION 480 TERRA



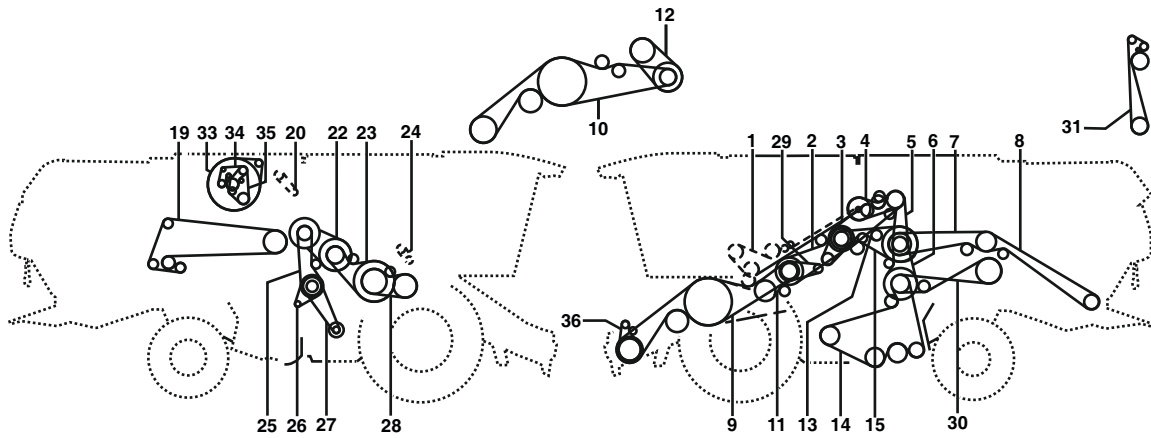



| Belt No. |  | No. of Belts | OEM  Part No. | PIX  Part No. |
|----------|---|--------------|--|--|
| 1 | | 1 | 667255.0 | A-667255.0 |
| 2 | | 1 | 667881.0 | A-667881.0 |
| 3 | | 1 | 667250.0 | A-667250.0 |
| 4 | | 1 | 644966.0 | A-644966.0 |
| 4 | | 1 | 644685.1 | A-644685.1 |
| 5 | | 1 | 667252.0 | A-667252.0 |
| 6 | | 1 | 644889.0 | A-644889.0 |
| 6 | | 1 | 061700.1 | A-061700.1 |
| 7 | | 1 | 644890.0 | A-644890.0 |
| 7 | | 1 | 749712.0 | A-749712.0 |
| 8 | | 2 | 667454.0 | A-667454.0 |
| 9 | | 2 | 667551.1 | A-667551.1 |
| 10 | | 1 | 667249.0 | A-667249.0 |
| 11 | | 1 | 667530.0 | A-667530.0 |
| 12 | | 1 | 233843.1 | A-233843.1 |
| 12 | | 1 | 758719.0 | A-758719.0 |
| 13 | | 1 | 644866.0 | A-644866.0 |
| 14 | | 1 | 644209.0 | A-644209.0 |
| 15 | | 1 | 667891.1 | A-667891.1 |
| 16 | | 1 | 644942.0 | A-644942.0 |
| 16 | | 1 | 667798.2 | A-667798.2 |
| 17 | | 1 | 667560.1 | A-667560.1 |
| 18 | | 1 | 667242.0 | A-667242.0 |
| 19 | | 1 | 667456.0 | A-667456.0 |
| 20 | | 1 | 629510.1 | A-629510.1 |
| 20 | | 1 | 667983.0 | A-667983.0 |
| 20 | | 1 | 667458.0 | A-667458.0 |
| 21 | | 1 | 749886.1 | A-749886.1 |
| 21 | | 1 | 667554.0 | A-667554.0 |
| 22 | | 1 | 667561.1 | A-667561.1 |
| 23 | | 1 | 667248.0 | A-667248.0 |
| 24 | | 1 | 176442.1 | A-176442.1 |
| 24 | | 1 | 667255.0 | A-667255.0 |
| 25 | | 1 | 742026.0 | A-742026.0 |
| 26 | | 1 | 667457.0 | A-667457.0 |
| 27 | | 1 | 667251.1 | A-667251.1 |
| 28 | | 1 | 644781.0 | A-644781.0 |



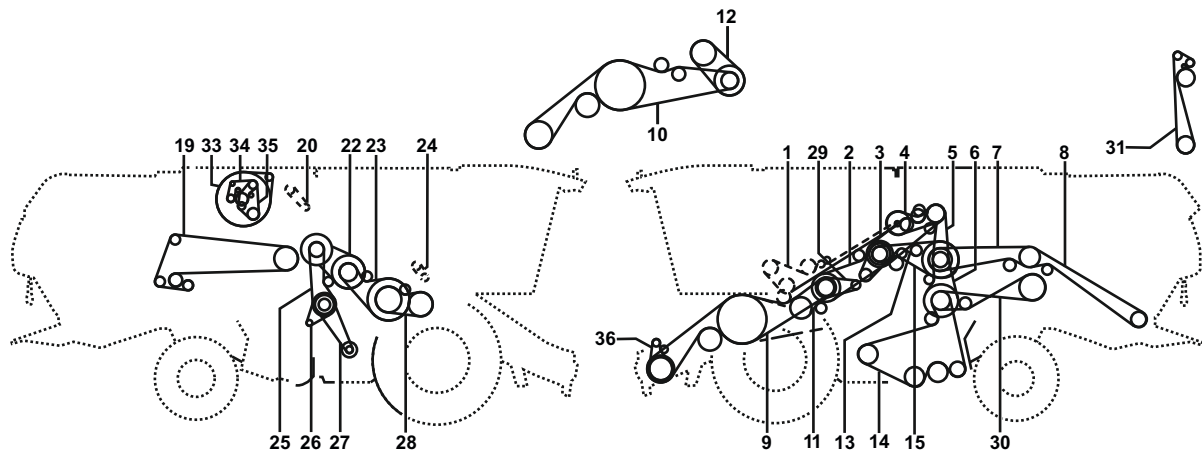

| Belt No. |  | No. of Belts | OEM  Part No. | PIX  Part No. |
|----------|---|--------------|--|--|
| 2 | Cutterbar Drive, 1ste Stage | 1 | 644892.0 | A-644892.0 |
| 3 | Threshing Mechanism Drive P02/540/541/560/P02 /670/671/680/681 | 1 | 352371.1 | A-352371.1 |
| 3 | Threshing Mechanism Drive P02/590/591/660/661 | 1 | 667453.0 | A-667453.0 |
| 4 | Grain Tank Unloading | 1 | 667250.0 | A-667250.0 |
| 5 | Chopper Drive, 1ste Stage At Motor 3126b and C9 - Exhaust Level 3a | 1 | 667958.3 | A-667958.3 |
| 5 | Chopper Drive, 1ste Stage At Motor C6.6 | 1 | 355696.0 | A-355696.0 |
| 6 | Sieve Pan, 2nd Stage | 1 | 667252.0 | A-667252.0 |
| 7 | Chopper Drive, 2nd Stage | 1 | 061700.1 | A-061700.1 |
| 8 | Chopper Drive, 3rd Stage Rigid Chopper | 1 | 628888.0 | A-628888.0 |
| 9 | Cutterbar Drive, 2nd Stage Without Vari. Speed Drive | 2 | 667454.0 | A-667454.0 |
| 10 | Cutterbar Drive, 3rd Stage With Variable Speed Drive | 2 | 667551.1 | A-667551.1 |
| 11 | Synchronous Drive | 1 | 667249.0 | A-667249.0 |
| 12 | Cutterbar Variator | 1 | 667530.1 | A-667530.1 |
| 13 | Chaff Spreader | 1 | 746508.1 | A-746508.1 |
| 14 | Cleaning, 3rd Stage | 1 | 667651.0 | A-667651.0 |
| 15 | Cleaning, 1ste Stage | 1 | 644209.0 | A-644209.0 |
| 19 | Finger Roller | 1 | 628991.0 | A-628991.0 |
| 22 | Drum Variator From No. 58300369 | 1 | 667248.0 | A-667248.0 |
| 22 | Drum Variator | 1 | 661427.0 | A-661427.0 |
| 23 | Drum Drive | 1 | 176442.1 | A-176442.1 |
| 23 | Drum Drive | 1 | 644902.0 | A-644902.0 |
| 25 | Fan Drive | 2 | 778717.1 | A-778717.1 |
| 26 | Suction Blower | 1 | 644843.0 | A-644843.0 |
| 27 | Fan Variator | 1 | 667457.0 | A-667457.0 |
| 28 | Pre - Drum Drive | 1 | 667251.1 | A-667251.1 |
| 29 | Hydraulic Reel Drive | 1 | 829094.0 | A-829094.0 |
| 30 | Straw Walker Drive | 1 | 667477.0 | A-667477.0 |
| 31 | Straw Spreader | 1 | 539443.0 | A-539443.0 |
| 33 | Radiator Screen 2nd Stage | 1 | 545689.0 | A-545689.0 |
| 34 | At Motor 3126b | 1 | 796474.0 | A-796474.0 |
| 35 | Fan Drive At Motor 3126b | 1 | 796450.0 | A-796450.0 |
| 35 | At Motor C9 | 1 | 584627.1 | A-584627.1 |
| 35 | At Motor C6.6 | 1 | 580157.0 | A-580157.0 |
| 36 | Suction Blower E - Channel | 1 | 765985.0 | A-765985.0 |

CLAAS LEXION 520 MONTANA



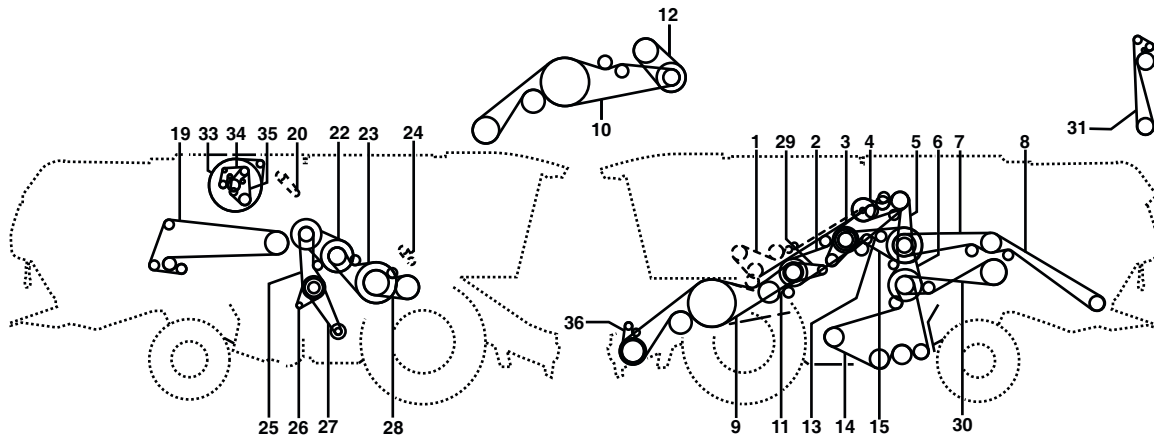

| Belt No. |  | No. of Belts | OEM  Part No. | PIX  Part No. |
|----------|---|--------------|--|--|
| 2 | Cutterbar Drive 1ste Stage | 1 | 644892.0 | A-644892.0 |
| 3 | Threshing Mechanism Drive P02/540/541/670/671 | 1 | 352371.1 | A-352371.1 |
| 3 | Threshing Mechanism Drive P02/660/661 From No. 58200137 | 1 | 352403.0 | A-352403.0 |
| 3 | Threshing Mechanism Drive P02/590/591 P02/660/661 | 1 | 667453.0 | A-667453.0 |
| 4 | Grain Tank Unloading | 1 | 667250.0 | A-667250.0 |
| 5 | Chopper Drive, 1ste Stage At Motor 3126b, C9 | 1 | 667958.3 | A-667958.3 |
| 5 | Chopper Drive, 1ste Stage At Motor C6.6 | 1 | 355696.0 | A-355696.0 |
| 6 | Sieve Pan 2nd Stage | 1 | 667252.0 | A-667252.0 |
| 7 | Chopper Drive, 2nd Stage | 1 | 061700.1 | A-061700.1 |
| 8 | Chopper Drive, 3rd Stage Rigid Chopper | 1 | 628888.0 | A-628888.0 |
| 9 | Cutterbar Drive, 2nd Stage Without Vari. Speed Drive | 2 | 667454.0 | A-667454.0 |
| 10 | Cutterbar Drive 3rd Stage With Variable Speed Drive | 2 | 667551.1 | A-667551.1 |
| 11 | Synchronous Drive | 1 | 667249.0 | A-667249.0 |
| 12 | Cutterbar Variator | 1 | 667530.1 | A-667530.1 |
| 13 | Chaff Spreader | 1 | 746508.1 | A-746508.1 |
| 14 | Cleaning, 3rd Stage | 1 | 667651.0 | A-667651.0 |
| 15 | Cleaning, 1ste Stage | 1 | 644209.0 | A-644209.0 |
| 19 | Finger Roller | 1 | 628991.0 | A-628991.0 |
| 22 | Drum Variator | 1 | 667248.0 | A-667248.0 |
| 23 | Drum Drive | 1 | 176442.1 | A-176442.1 |
| 25 | Fan Drive | 4 | 746506.0 | A-746506.0 |
| 26 | Suction Fan | 1 | 644781.0 | A-644781.0 |
| 27 | Fan Variator | 1 | 667457.0 | A-667457.0 |
| 28 | Pre - Drum Drive | 1 | 667251.1 | A-667251.1 |
| 29 | Hydraulic Reel Drive | 1 | 829094.0 | A-829094.0 |
| 30 | Straw Walker Drive | 1 | 667477.0 | A-667477.0 |
| 31 | Straw Spreader | 1 | 539443.0 | A-539443.0 |
| 33 | Radiator Screen 2nd Stage | 1 | 545689.0 | A-545689.0 |
| 34 | At Motor 3126b | 1 | 796474.0 | A-796474.0 |
| 35 | Fan Drive At Motor 3126b | 1 | 796450.0 | A-796450.0 |
| 35 | At Motor C9 | 1 | 584627.1 | A-584627.1 |
| 35 | At Motor C6.6 | 1 | 580157.0 | A-580157.0 |
| 36 | Suction Blower E - Channel | 1 | 765985.0 | A-765985.0 |

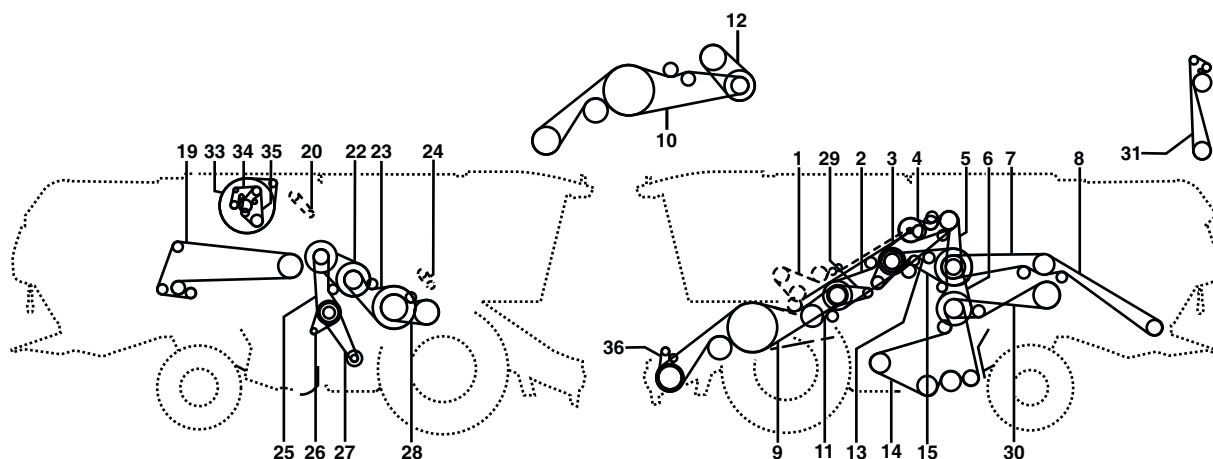

| Belt No. |  | No. of Belts | OEM  Part No. | PIX  Part No. |
|----------|---|--------------|--|--|
| 2 | Cutterbar Drive, 1ste Stage | 1 | 644892.0 | A-644892.0 |
| 3 | Threshing Mechanism Drive P02/540/541/560/P02/670/671/680/681 | 1 | 352371.1 | A-352371.1 |
| 3 | Threshing Mechanism Drive P02/590/591/660/661 | 1 | 667453.0 | A-667453.0 |
| 4 | Grain Tank Unloading | 1 | 667250.0 | A-667250.0 |
| 5 | Chopper Drive, 1ste Stage At Motor 3126b & C9 - Exhaust Level 3A | 1 | 667958.3 | A-667958.3 |
| 5 | Chopper Drive, 1ste Stage At Motor C6.6 | 1 | 355696.0 | A-355696.0 |
| 6 | Sieve Pan, 2nd Stage | 1 | 667252.0 | A-667252.0 |
| 7 | Chopper Drive, 2nd Stage | 1 | 061700.1 | A-061700.1 |
| 8 | Chopper Drive, 3rd Stage Rigid Chopper | 1 | 628888.0 | A-628888.0 |
| 9 | Cutterbar Drive, 2nd Stage W/o Variable Speed Drive | 2 | 667454.0 | A-667454.0 |
| 10 | Cutterbar Drive, 3rd Stage With Variable Speed Drive | 2 | 667551.1 | A-667551.1 |
| 11 | Synchronous Drive | 1 | 667249.0 | A-667249.0 |
| 12 | Cutterbar Variator | 1 | 667530.1 | A-667530.1 |
| 13 | Chaff Spreader | 1 | 746508.1 | A-746508.1 |
| 14 | Cleaning, 3rd Stage | 1 | 667651.0 | A-667651.0 |
| 15 | Cleaning, 1ste Stage | 1 | 644209.0 | A-644209.0 |
| 19 | Finger Roller | 1 | 628991.0 | A-628991.0 |
| 22 | Drum Variator From No. 58300369 | 1 | 667248.0 | A-667248.0 |
| 23 | Drum Drive Lexion 530, 520, 510 From No. 58300369 | 1 | 176442.1 | A-176442.1 |
| 25 | Fan Drive | 4 | 746506.0 | A-746506.0 |
| 26 | Suction Blower | 1 | 644781.0 | A-644781.0 |
| 27 | Fan Variator | 1 | 667457.0 | A-667457.0 |
| 28 | Pre - Drum Drive | 1 | 667251.1 | A-667251.1 |
| 29 | Hydraulic Reel Drive | 1 | 829094.0 | A-829094.0 |
| 30 | Straw Walker Drive | 1 | 667477.0 | A-667477.0 |
| 31 | Straw Spreader | 1 | 539443.0 | A-539443.0 |
| 33 | Radiator Screen 2nd Stage | 1 | 545689.0 | A-545689.0 |
| 34 | At Motor 3126b | 1 | 796474.0 | A-796474.0 |
| 35 | Fan Drive At Motor 3126b | 1 | 796450.0 | A-796450.0 |
| 35 | At Motor C9 | 1 | 584627.1 | A-584627.1 |
| 35 | At Motor C6.6 | 1 | 580157.0 | A-580157.0 |
| 36 | Suction Blower E - Channel | 1 | 765985.0 | A-765985.0 |

CLAAS LEXION 530 MONTANA

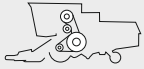

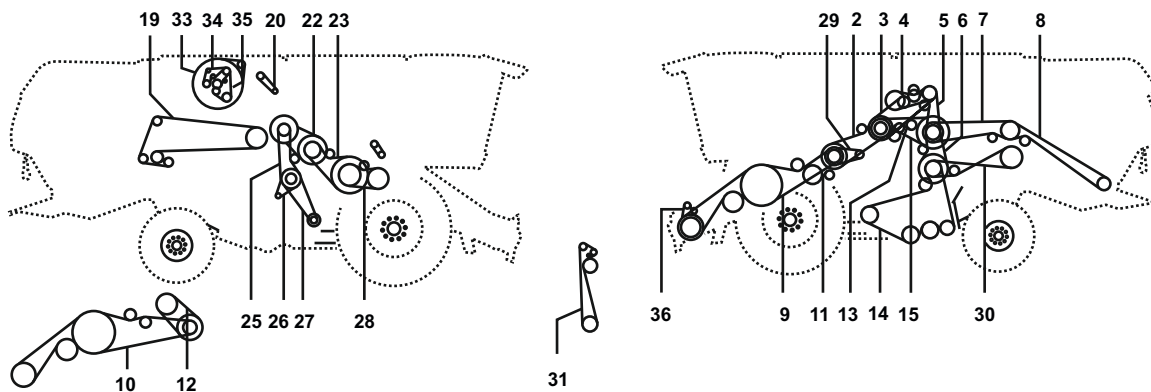

| Belt No. |  | No. of Belts | OEM  Part No. | PIX  Part No. |
|----------|---|--------------|--|--|
| 2 | Cutterbar Drive 1ste Stage | 1 | 644892.0 | A-644892.0 |
| 3 | Threshing Mechanism Drive P02/540/541/670/671 | 1 | 352371.1 | A-352371.1 |
| 3 | Threshing Mechanism Drive P02/660/661 From No. 58200137 | 1 | 352403.0 | A-352403.0 |
| 3 | Threshing Mechanism Drive P02/590/591 P02/660/661 | 1 | 667453.0 | A-667453.0 |
| 4 | Grain Tank Unloading | 1 | 667250.0 | A-667250.0 |
| 5 | Chopper Drive, 1ste Stage At Motor 3126b, C9 | 1 | 667958.3 | A-667958.3 |
| 5 | Chopper Drive, 1ste Stage At Motor C6.6 | 1 | 355696.0 | A-355696.0 |
| 6 | Sieve Pan 2nd Stage | 1 | 667252.0 | A-667252.0 |
| 7 | Chopper Drive, 2nd Stage | 1 | 061700.1 | A-061700.1 |
| 8 | Chopper Drive, 3rd Stage Rigid Chopper | 1 | 628888.0 | A-628888.0 |
| 9 | Cutterbar Drive, 2nd Stage W/o Variable Speed Drive | 2 | 667454.0 | A-667454.0 |
| 10 | Cutterbar Drive 3rd Stage With Variable Speed Drive | 2 | 667551.1 | A-667551.1 |
| 11 | Synchronous Drive | 1 | 667249.0 | A-667249.0 |
| 12 | Cutterbar Variator | 1 | 667530.1 | A-667530.1 |
| 13 | Chaff Spreader | 1 | 746508.1 | A-746508.1 |
| 14 | Cleaning, 3rd Stage | 1 | 667651.0 | A-667651.0 |
| 15 | Cleaning, 1ste Stage | 1 | 644209.0 | A-644209.0 |
| 19 | Finger Roller | 1 | 628991.0 | A-628991.0 |
| 22 | Drum Variator | 1 | 667248.0 | A-667248.0 |
| 23 | Drum Drive | 1 | 176442.1 | A-176442.1 |
| 25 | Fan Drive | 4 | 746506.0 | A-746506.0 |
| 26 | Suction Fan | 1 | 644781.0 | A-644781.0 |
| 27 | Fan Variator | 1 | 667457.0 | A-667457.0 |
| 28 | Pre - Drum Drive | 1 | 667251.1 | A-667251.1 |
| 29 | Hydraulic Reel Drive | 1 | 829094.0 | A-829094.0 |
| 30 | Straw Walker Drive | 1 | 667477.0 | A-667477.0 |
| 31 | Straw Spreader | 1 | 539443.0 | A-539443.0 |
| 33 | Radiator Screen 2nd Stage | 1 | 545689.0 | A-545689.0 |
| 34 | At Motor 3126b | 1 | 796474.0 | A-796474.0 |
| 35 | Fan Drive At Motor 3126b | 1 | 796450.0 | A-796450.0 |
| 35 | At Motor C9 | 1 | 584627.1 | A-584627.1 |
| 35 | At Motor C6.6 | 1 | 580157.0 | A-580157.0 |
| 36 | Suction Blower E - Channel | 1 | 765985.0 | A-765985.0 |





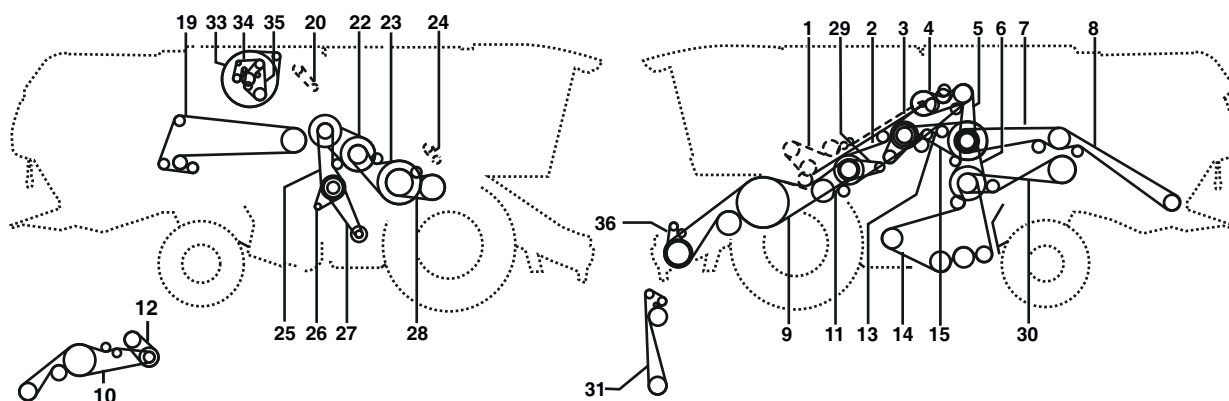

| Belt No. |  | No. of Belts | OEM  Part No. | PIX  Part No. |
|----------|---|--------------|--|--|
| 2 | Cutterbar Drive, 1ste Stage | 1 | 644892.0 | A-644892.0 |
| 3 | Threshing Mechanism At Caterpillar C13, C10 | 1 | 667881.0 | A-667881.0 |
| 3 | Threshing Mechanism Engine C9 | 1 | 352403.0 | A-352403.0 |
| 3 | Threshing Mechanism Engine 3126b, C6.6 | 1 | 667453.0 | A-667453.0 |
| 4 | Discharge Drive Grain Tank | 1 | 667250.0 | A-667250.0 |
| 5 | Chopper Drive - 1st Stage at Motor C13, C10, C9 and 3126b | 1 | 667958.3 | A-667958.3 |
| 5 | Chopper Drive - 1st Stage At Motor C6.6 | 1 | 355696.0 | A-355696.0 |
| 6 | Sieve Pan Drive - 2nd Stage | 1 | 667252.0 | A-667252.0 |
| 7 | Chopper Drive - 2nd Stage | 1 | 061700.1 | A-061700.1 |
| 8 | Chopper Drive - 3rd Stage Rigid Chopper | 1 | 628888.0 | A-628888.0 |
| 9 | Cutterbar Drive, 2nd Stage W/o Variable Speed Drive | 2 | 667454.0 | A-667454.0 |
| 10 | Cutterbar Drive, 3rd Stage With Variable Speed Drive | 2 | 667551.1 | A-667551.1 |
| 11 | Synchronous Drive | 1 | 667249.0 | A-667249.0 |
| 12 | Cutterbar Drive With Variable Speed Drive | 1 | 667530.1 | A-667530.1 |
| 13 | Chaff Spreader Drive | 1 | 746508.1 | A-746508.1 |
| 14 | Cleaning - 3rd Stage | 1 | 667651.0 | A-667651.0 |
| 15 | Cleaning - 1st Stage | 1 | 644209.0 | A-644209.0 |
| 19 | Finger Roller | 1 | 628991.0 | A-628991.0 |
| 22 | Drum Drive Variable Speed | 1 | 667248.0 | A-667248.0 |
| 23 | Drum Drive | 1 | 176442.1 | A-176442.1 |
| 25 | Fan Drive | 4 | 746506.0 | A-746506.0 |
| 26 | Suction Fan | 1 | 644781.0 | A-644781.0 |
| 27 | Fan Drive Variable Speed | 1 | 667457.0 | A-667457.0 |
| 28 | Pre-drum Drive | 1 | 667251.1 | A-667251.1 |
| 29 | Hydraulic Reel Pump Drive | 1 | 829094.0 | A-829094.0 |
| 30 | Straw Walker Drive | 1 | 667477.0 | A-667477.0 |
| 31 | Straw Spreader Drive | 1 | 539443.0 | A-539443.0 |
| 33 | Radiator Screen - 2nd Stage | 1 | 545689.0 | A-545689.0 |
| 34 | Engine C9 Emission Standard 2 | 1 | 796786.0 | A-796786.0 |
| 34 | Engine 3126 B | 1 | 796474.0 | A-796474.0 |
| 35 | Fan Drive - Engine C10, C13 (from Nr. 58401487) | 1 | 628964.1 | A-628964.1 |
| 35 | Fan Drive (up To Nr. 58401486) | 1 | 743910.1 | A-743910.1 |
| 35 | Fan Drive - Engine 3126b and At C9-Emission Std. | 1 | 796450.0 | A-796450.0 |
| 35 | Fan Drive C9-exhaust Level 3a | 1 | 584627.1 | A-584627.1 |
| 35 | Fan Drive At Motor C6.6 | 1 | 580157.0 | A-580157.0 |
| 36 | Suction Blower E.-channel | 1 | 765985.0 | A-765985.0 |

CLAAS LEXION 550 MONTANA

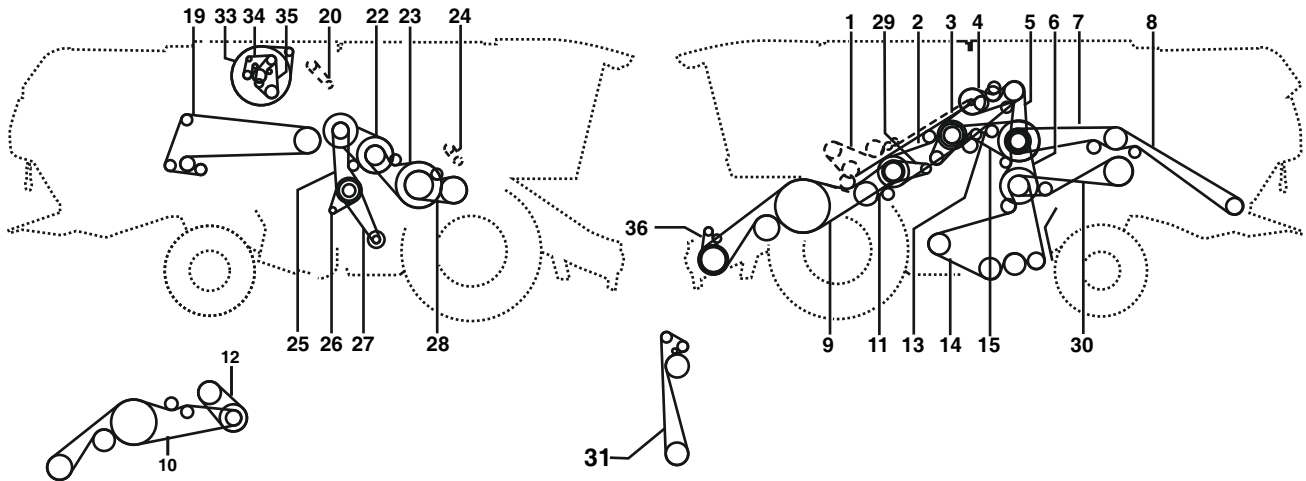



| Belt No. |  | No. of Belts | OEM  Part No. | PIX  Part No. |
|----------|---|--------------|--|--|
| 2 | Cutterbar Drive 1ste Stage | 1 | 644892.0 | A-644892.0 |
| 3 | Threshing Mechanism Drive Engine C10 | 1 | 667881.0 | A-667881.0 |
| 3 | Threshing Mechanism Drive Engine C9 | 1 | 352403.0 | A-352403.0 |
| 4 | Grain Tank Unloading | 1 | 667250.0 | A-667250.0 |
| 5 | Chopper Drive 1ste Stage | 1 | 667958.3 | A-667958.3 |
| 6 | Sieve Pan 2nd Stage | 1 | 667252.0 | A-667252.0 |
| 7 | Chopper Drive, 2nd Stage | 1 | 061700.1 | A-061700.1 |
| 8 | Chopper Drive, 3rd Stage Rigid Chopper | 1 | 628888.0 | A-628888.0 |
| 9 | Cutterbar Drive, 2nd Stage W/o Variable Speed Drive | 2 | 667454.0 | A-667454.0 |
| 10 | Cutterbar Drive 3rd Stage With Variable Speed Drive | 2 | 667551.1 | A-667551.1 |
| 11 | Synchronous Drive | 1 | 667249.0 | A-667249.0 |
| 12 | Cutterbar Variator | 1 | 667530.1 | A-667530.1 |
| 13 | Chaff Spreader | 1 | 746508.1 | A-746508.1 |
| 14 | Cleaning 3rd Stage | 1 | 667651.0 | A-667651.0 |
| 15 | Cleaning 1ste Stage | 1 | 644209.0 | A-644209.0 |
| 19 | Finger Roller | 1 | 628991.0 | A-628991.0 |
| 22 | Drum Variator | 1 | 667248.0 | A-667248.0 |
| 23 | Drum Drive | 1 | 176442.1 | A-176442.1 |
| 25 | Fan Drive | 4 | 746506.0 | A-746506.0 |
| 26 | Suction Fan | 1 | 644781.0 | A-644781.0 |
| 27 | Fan Variator | 1 | 667457.0 | A-667457.0 |
| 28 | Pre - Drum Drive | 1 | 667251.1 | A-667251.1 |
| 29 | Hydraulic Reel Drive | 1 | 829094.0 | A-829094.0 |
| 30 | Straw Walker Drive | 1 | 667477.0 | A-667477.0 |
| 31 | Straw Spreader | 1 | 539443.0 | A-539443.0 |
| 33 | Radiator Screen 2nd Stage | 1 | 545689.0 | A-545689.0 |
| 34 | Engine C9 | 1 | 796786.0 | A-796786.0 |
| 35 | Fan Drive Engine C10 From No. 58000036 | 1 | 628964.1 | A-628964.1 |
| 35 | Fan Drive Engine C10 To No. 58000035 | 1 | 743910.1 | A-743910.1 |
| 35 | Fan Drive C9 Emission Standard 2 | 1 | 796450.0 | A-796450.0 |
| 35 | Fan Drive C9 Exhaust Level 3a | 1 | 584627.1 | A-584627.1 |
| 36 | Suction Blower E - Channel | 1 | 765985.0 | A-765985.0 |

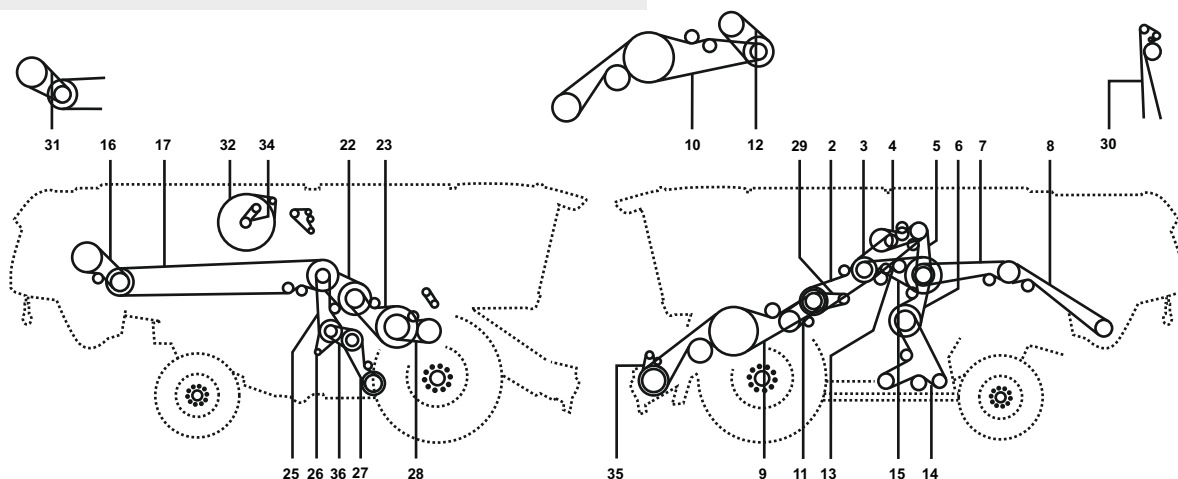

| Belt No. |  | No. of Belts | OEM  Part No. | PIX  Part No. |
|----------|---|--------------|--|--|
| 2 | Cutterbar Drive 1ste Stage | 1 | 644892.0 | A-644892.0 |
| 3 | Threshing Mechanism Drive Engine C10 | 1 | 667881.0 | A-667881.0 |
| 3 | Threshing Mechanism Drive Engine C9 | 1 | 352403.0 | A-352403.0 |
| 4 | Grain Tank Unloading | 1 | 667250.0 | A-667250.0 |
| 5 | Chopper Drive 1ste Stage | 1 | 667958.3 | A-667958.3 |
| 6 | Sieve Pan 2nd Stage | 1 | 667252.0 | A-667252.0 |
| 7 | Chopper Drive, 2nd Stage | 1 | 061700.1 | A-061700.1 |
| 8 | Chopper Drive, 3rd Stage Rigid Chopper | 1 | 628888.0 | A-628888.0 |
| 9 | Cutterbar Drive, 2nd Stage W/o Variable Speed Drive | 2 | 667454.0 | A-667454.0 |
| 10 | Cutterbar Drive 3rd Stage With Variable Speed Drive | 2 | 667551.1 | A-667551.1 |
| 11 | Synchronous Drive | 1 | 667249.0 | A-667249.0 |
| 12 | Cutterbar Variator | 1 | 667530.1 | A-667530.1 |
| 13 | Chaff Spreader | 1 | 746508.1 | A-746508.1 |
| 14 | Cleaning 3rd Stage | 1 | 667651.0 | A-667651.0 |
| 15 | Cleaning 1ste Stage | 1 | 644209.0 | A-644209.0 |
| 19 | Finger Roller | 1 | 628991.0 | A-628991.0 |
| 22 | Drum Variator | 1 | 667248.0 | A-667248.0 |
| 23 | Drum Drive | 1 | 176442.1 | A-176442.1 |
| 25 | Fan Drive | 4 | 746506.0 | A-746506.0 |
| 26 | Suction Fan | 1 | 644781.0 | A-644781.0 |
| 27 | Fan Variator | 1 | 667457.0 | A-667457.0 |
| 28 | Pre - Drum Drive | 1 | 667251.1 | A-667251.1 |
| 29 | Hydraulic Reel Drive | 1 | 829094.0 | A-829094.0 |
| 30 | Straw Walker Drive | 1 | 667477.0 | A-667477.0 |
| 31 | Straw Spreader | 1 | 539443.0 | A-539443.0 |
| 33 | Radiator Screen 2nd Stage | 1 | 545689.0 | A-545689.0 |
| 34 | Engine C9 | 1 | 796786.0 | A-796786.0 |
| 35 | Fan Drive Engine C10 From No. 58000036 | 1 | 628964.1 | A-628964.1 |
| 35 | Fan Drive Engine C10 To No. 58000035 | 1 | 743910.1 | A-743910.1 |
| 35 | Fan Drive C9 Emission Standard 2 | 1 | 796450.0 | A-796450.0 |
| 35 | Fan Drive C9 Exhaust Level 3a | 1 | 584627.1 | A-584627.1 |
| 36 | Suction Blower E - Channel | 1 | 765985.0 | A-765985.0 |

CLAAS LEXION 570



| Belt No. |  | No. of Belts | OEM  Part No. | PIX  Part No. |
|----------|---|--------------|--|--|
| 2 | Cutterbar Drive, 1ste Stage | 1 | 644892.0 | A-644892.0 |
| 3 | Threshing Mechanism Drive | 1 | 667452.1 | A-667452.1 |
| 4 | Discharge Drive Grain Tank | 1 | 667250.0 | A-667250.0 |
| 5 | Chopper Drive - 1st Stage | 1 | 667958.3 | A-667958.3 |
| 6 | Sieve Pan Drive - 2nd Stage (From Nr. 58500163-58500093-107) | 1 | 644902.0 | A-644902.0 |
| 6 | To Nr. 58500092 -nr. 58500108-162 | 1 | 667252.0 | A-667252.0 |
| 7 | Chopper Drive - 2nd Stage | 1 | 061700.1 | A-061700.1 |
| 8 | Chopper Drive - 3rd Stage | 1 | 628978.0 | A-628978.0 |
| 9 | Cutterbar Drive, 2nd Stage W/o Variable Speed Drive | 2 | 667454.0 | A-667454.0 |
| 10 | Cutterbar Drive, 3rd Stage With Variable Speed Drive | 2 | 667551.1 | A-667551.1 |
| 11 | Synchronous Drive | 1 | 667249.0 | A-667249.0 |
| 12 | Cutterbar Drive With Variable Speed Drive | 1 | 667530.1 | A-667530.1 |
| 13 | Chaff Spreader Drive | 1 | 746508.1 | A-746508.1 |
| 14 | Cleaning-3rd Stage (Nr. 58500163-58500093-107) | 1 | 756466.0 | A-756466.0 |
| 14 | Cleaning (to Nr. 58500092 - Nr. 58500108-162) | 1 | 667651.0 | A-667651.0 |
| 15 | Cleaning - 1st Stage | 1 | 644209.0 | A-644209.0 |
| 16 | Hybrid Drive - 2nd Stage (from Nr. 58500163) | 1 | 628792.0 | A-628792.0 |
| 16 | Hybrid Drive - 2nd Stage (up To Nr. 58500162) | 1 | 749895.0 | A-749895.0 |
| 17 | Hybrid Drive - 1st Stage | 1 | 749886.1 | A-749886.1 |
| 22 | Drum Drive Variable Speed | 1 | 667248.0 | A-667248.0 |
| 23 | Drum Drive | 1 | 176442.1 | A-176442.1 |
| 25 | Fan Drive (from Nr. 58500163-nr. 58500093-107) | 1 | 667957.0 | A-667957.0 |
| 25 | Fan Drive (to Nr. 58500092 -nr. 58500108-162) | 4 | 746506.0 | A-746506.0 |
| 26 | Suction Blower (from Nr. 58500163-nr. 58500093-107) | 1 | 667367.0 | A-667367.0 |
| 26 | Suction Blower (to Nr. 58500092-nr. 58500108-162) | 1 | 644781.0 | A-644781.0 |
| 27 | Fan Drive Variable Speed (from Nr. 58500163-Nr. 58500093-107) | 1 | 744785.0 | A-744785.0 |
| 27 | Fan Drive Variable Speed (to Nr. 58100092 - Nr. 58500108-162) | 1 | 667457.0 | A-667457.0 |
| 28 | Pre-drum Drive | 1 | 667251.1 | A-667251.1 |
| 29 | Hydraulic Reel Pump Drive | 1 | 829094.0 | A-829094.0 |
| 30 | Straw Spreader Drive | 1 | 539443.0 | A-539443.0 |
| 31 | Hybrid Drive - 2nd Stage (from Nr. 58500163) | 1 | 744965.0 | A-744965.0 |
| 31 | Hybrid Variable Speed Drive (up To Nr. 58500162) | 1 | 667248.0 | A-667248.0 |
| 32 | Radiator Screen - 2nd Stage | 1 | 545689.0 | A-545689.0 |
| 34 | Fan Drive (from Nr. 58500253) | 1 | 628964.1 | A-628964.1 |
| 34 | Fan Drive (up To Nr. 58500252) | 1 | 743910.1 | A-743910.1 |
| 35 | Suction Blower E.-channel | 1 | 765985.0 | A-765985.0 |
| 36 | From Nr. 58500163-nr. 58500093-107 | 1 | 628847.1 | A-628847.1 |

CLAAS LEXION 570 MONTANA

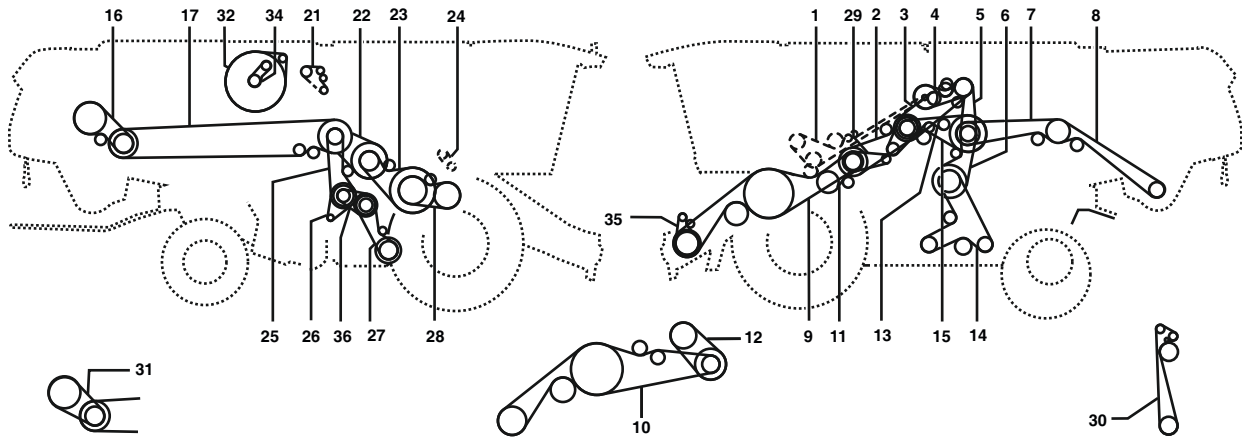



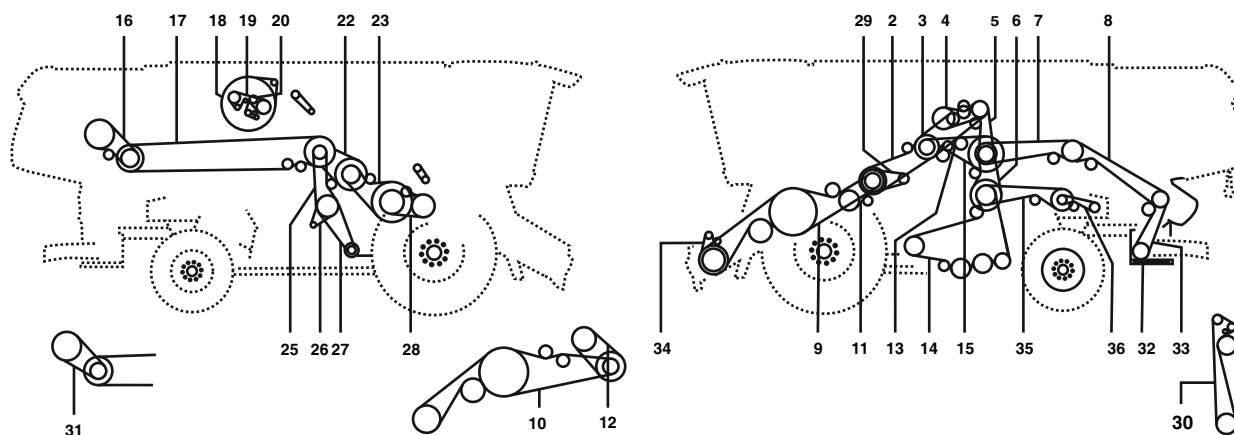

| Belt No. |  | No. of Belts | OEM  Part No. | PIX  Part No. |
|----------|---|--------------|--|--|
| 2 | Cutterbar Drive, 1ste Stage | 1 | 644892.0 | A-644892.0 |
| 3 | Threshing Mechanism Drive | 1 | 667452.1 | A-667452.1 |
| 4 | Grain Tank Unloading | 1 | 667250.0 | A-667250.0 |
| 5 | Chopper Drive 1ste Stage | 1 | 667958.3 | A-667958.3 |
| 6 | Sieve Pan 2nd Stage From No. 58100038 | 1 | 644902.0 | A-644902.0 |
| 6 | To No. 58100037 | 1 | 667252.0 | A-667252.0 |
| 7 | Chopper Drive, 2nd Stage From No. 58100187 | 1 | 644889.0 | A-644889.0 |
| 7 | Chopper Drive, 2nd Stage To No. 58100186 | 1 | 061700.1 | A-061700.1 |
| 8 | Chopper Drive, 3rd Stage | 1 | 628978.0 | A-628978.0 |
| 9 | Cutterbar Drive, 2nd Stage W/o Variable Speed Drive | 2 | 667454.0 | A-667454.0 |
| 10 | Cutterbar Drive 3rd Stage With Variable Speed Drive | 2 | 667551.1 | A-667551.1 |
| 11 | Synchronous Drive | 1 | 667249.0 | A-667249.0 |
| 12 | Cutterbar Variator | 1 | 667530.1 | A-667530.1 |
| 13 | Chaff Spreader | 1 | 746508.1 | A-746508.1 |
| 14 | Cleaning, 3rd Stage From No. 58100038 | 1 | 756466.0 | A-756466.0 |
| 14 | To No. 58100037 | 1 | 667651.0 | A-667651.0 |
| 15 | Cleaning 1ste Stage | 1 | 644209.0 | A-644209.0 |
| 16 | Hybrid Drive 2nd Stage From No. 58100038 | 1 | 628792.0 | A-628792.0 |
| 16 | Hybrid Drive 2nd Stage Tono. 58100037 | 1 | 749895.0 | A-749895.0 |
| 17 | Hybrid Drive 1ste From No. 58100038 | 1 | 644961.0 | A-644961.0 |
| 17 | To No. 58100037 | 1 | 749886.1 | A-749886.1 |
| 22 | Drum Variator | 1 | 667248.0 | A-667248.0 |
| 23 | Drum Drive | 1 | 176442.1 | A-176442.1 |
| 25 | Fan Drive From No. 58100038 | 1 | 667957.0 | A-667957.0 |
| 25 | To No. 58100037 | 4 | 746506.0 | A-746506.0 |
| 26 | Suction Blower From No. 58100038 | 1 | 667367.0 | A-667367.0 |
| 26 | To No. 58100037 | 1 | 644781.0 | A-644781.0 |
| 27 | Fan Variatorfrom No. 58100038 | 1 | 744785.0 | A-744785.0 |
| 27 | To No. 58100037 | 1 | 667457.0 | A-667457.0 |
| 28 | Pre - Drum Drive | 1 | 667251.1 | A-667251.1 |
| 29 | Hydraulic Reel Drive | 1 | 829094.0 | A-829094.0 |
| 30 | Straw Spreader | 1 | 539443.0 | A-539443.0 |
| 31 | Hybrid Drive 2nd Stage | 1 | 744965.0 | A-744965.0 |
| 31 | From No. 58100038 | 1 | 667248.0 | A-667248.0 |
| 32 | Hybrid Variable Speed Drive To No. 58100037 | 1 | 545689.0 | A-545689.0 |
| 34 | Radiator Screen 2nd Stage | 1 | 628964.1 | A-628964.1 |
| 34 | Fan Drive From No. 58100038 | 1 | 743910.1 | A-743910.1 |
| 35 | Fan Drive To No. 58100037 | 1 | 765985.0 | A-765985.0 |
| 36 | Suction Blower E - Channel From No. 58100038 | 1 | 628847.1 | A-628847.1 |

CLAAS LEXION 580

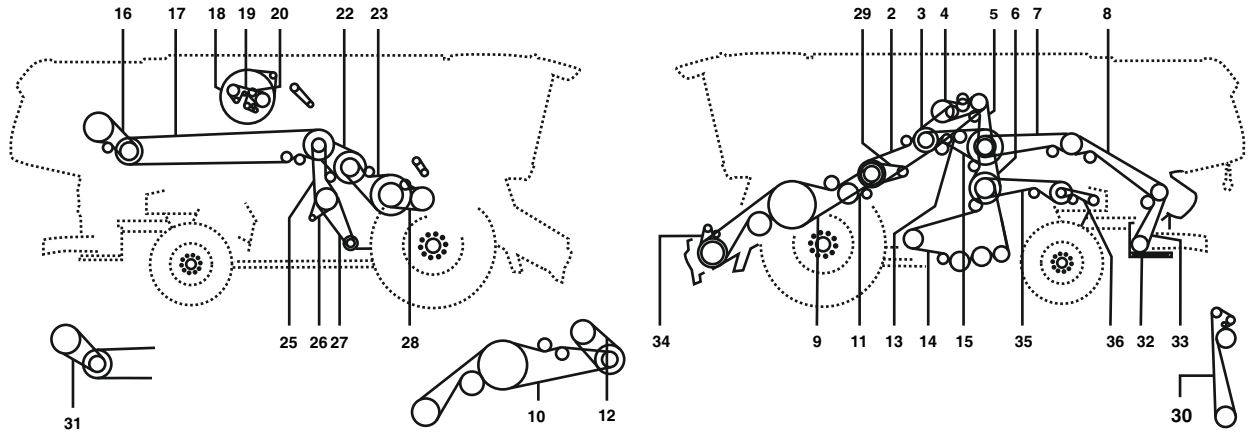

| Belt No. |  | No. of Belts | OEM  Part No. | PIX  Part No. |
|----------|---|--------------|--|--|
| 2 | Cutterbar Drive, 1ste Stage | 1 | 644892.0 | A-644892.0 |
| 3 | Threshing Mechanism Drive | 1 | 644884.0 | A-644884.0 |
| 4 | Discharge Drive Grain Tank | 1 | 667981.2 | A-667981.2 |
| 5 | Chopper Drive - 1st Stage | 1 | 644885.0 | A-644885.0 |
| 6 | Sieve Pan Drive - 2nd Stage | 1 | 667252.0 | A-667252.0 |
| 7 | Chopper Drive - 2nd Stage | 1 | 644889.0 | A-644889.0 |
| 8 | Chopper Drive - 3rd Stage Only For Rice | 1 | 628978.0 | A-628978.0 |
| 8 | Strengthened Drive | 1 | 644890.0 | A-644890.0 |
| 9 | Cutterbar Drive, 2nd Stage Without Variable Speed Drive | 2 | 667454.0 | A-667454.0 |
| 10 | Cutterbar Drive, 3rd Stage With Variable Speed Drive | 2 | 667551.1 | A-667551.1 |
| 11 | Synchronous Drive | 1 | 667249.0 | A-667249.0 |
| 12 | Cutterbar Drive With Variable Speed Drive | 1 | 667530.1 | A-667530.1 |
| 13 | At Chaff-, Straw- and Radial Spreader | 1 | 746508.1 | A-746508.1 |
| 13 | At Spreader Fan | 1 | 233843.1 | A-233843.1 |
| 14 | Cleaning - 3rd Stage | 1 | 644866.0 | A-644866.0 |
| 15 | Cleaning - 1st Stage | 1 | 644209.0 | A-644209.0 |
| 16 | Hybrid Drive - 2nd Stage (from Nr. 58600057) | 1 | 628792.0 | A-628792.0 |
| 16 | Hybrid Drive - 2nd Stage (up To Nr. 58600056) | 1 | 749895.0 | A-749895.0 |
| 17 | Hybrid Drive - 1st Stage | 1 | 749886.1 | A-749886.1 |
| 18 | Radiator Screen - 2nd Stage | 1 | 545689.0 | A-545689.0 |
| 19 | Fan Drive | 1 | 628964.1 | A-628964.1 |
| 20 | Engine | 1 | 744873.0 | A-744873.0 |
| 22 | Drum Drive Variable Speed | 1 | 667248.0 | A-667248.0 |
| 23 | Drum Drive | 1 | 644965.0 | A-644965.0 |
| 25 | Fan Drive | 4 | 746506.0 | A-746506.0 |
| 26 | Suction Fan | 1 | 644781.0 | A-644781.0 |
| 27 | Fan Drive Variable Speed | 1 | 667457.0 | A-667457.0 |
| 28 | Pre-drum Drive | 1 | 667251.1 | A-667251.1 |
| 29 | Hydraulic Reel Pump Drive | 1 | 829094.0 | A-829094.0 |
| 30 | Straw Spreader Drive | 1 | 539443.0 | A-539443.0 |
| 31 | Hybrid Variable Speed Drive (from Nr. 58600057) | 1 | 744965.0 | A-744965.0 |
| 31 | Hybrid Variable Speed Drive (up To Nr. 58600056) | 1 | 667248.0 | A-667248.0 |
| 32 | Spreader Fan - 2nd Stage | 1 | 667891.1 | A-667891.1 |
| 33 | Spreader Fan - 1st Stage (from Nr. 58600862) | 1 | 667252.0 | A-667252.0 |
| 33 | Spreader Fan - 1st Stage (to Nr. 58600861) | 1 | 644942.0 | A-644942.0 |





| Belt No. |  | No. of Belts | OEM  Part No. | PIX  Part No. |
|----------|---|--------------|--|--|
| 34 | Suction Blower E.-channel | 1 | 765985.0 | A-765985.0 |
| 35 | Feeder Base | 1 | 661425.0 | A-661425.0 |
| 36 | Feeder Base | 1 | 758719.0 | A-758719.0 |



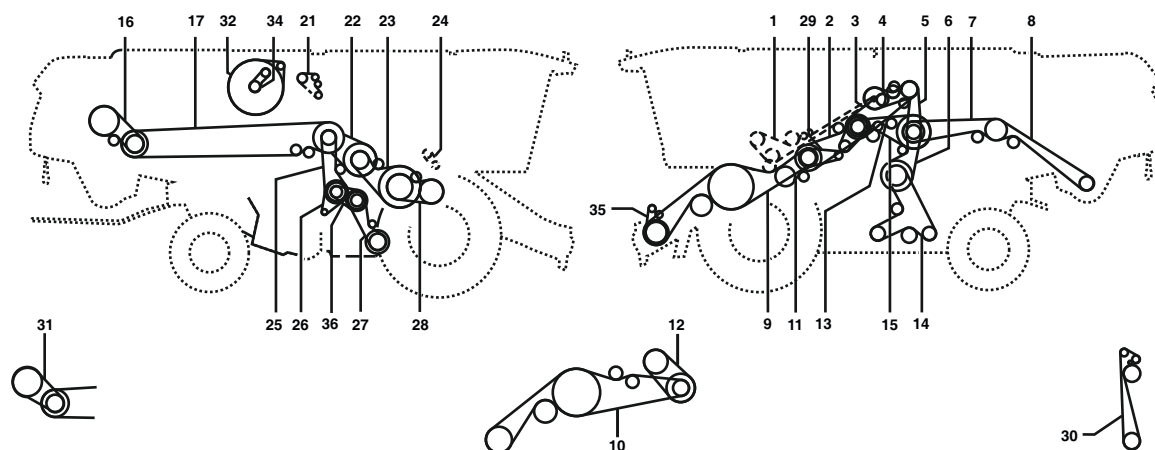

CLAAS LEXION 580 R AUSTRALIA



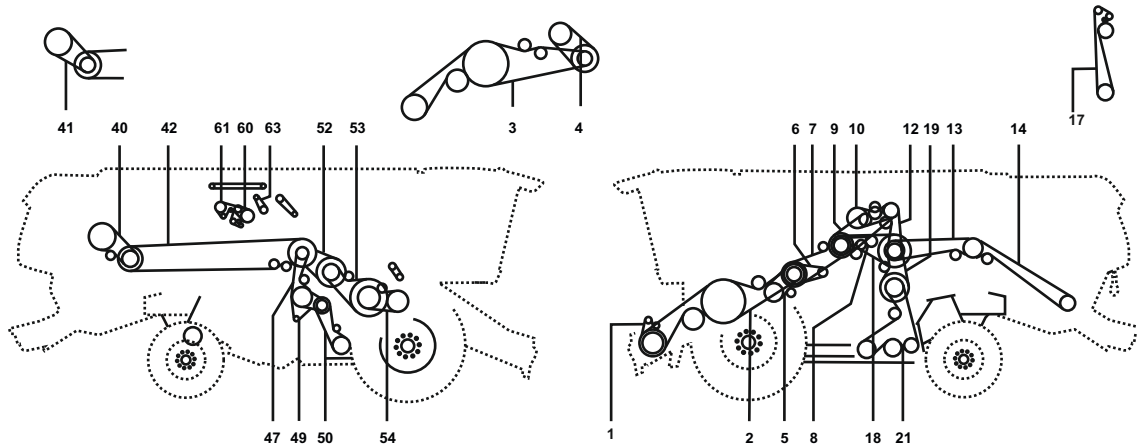



| Belt No. |  | No. of Belts | OEM  Part No. | PIX  Part No. |
|----------|---|--------------|--|--|
| 2 | Cutterbar Drive, 1ste Stage | 1 | 644892.0 | A-644892.0 |
| 3 | Threshing Mechanism Drive | 1 | 667452.1 | A-667452.1 |
| 4 | Grain Tank Unloading | 1 | 667250.0 | A-667250.0 |
| 5 | Chopper Drive 1ste Stage | 1 | 667958.3 | A-667958.3 |
| 6 | Sieve Pan 2nd Stage | 1 | 644902.0 | A-644902.0 |
| 7 | Chopper Drive, 2nd Stage | 1 | 644890.0 | A-644890.0 |
| 8 | Chopper Drive, 3rd Stage | 1 | 355658.0 | A-355658.0 |
| 9 | Cutterbar Drive, 2nd Stage W/o Variable Speed Drive | 2 | 667454.0 | A-667454.0 |
| 10 | Cutterbar Drive 3rd Stage With Variable Speed Drive | 2 | 667551.1 | A-667551.1 |
| 11 | Synchronous Drive | 1 | 667249.0 | A-667249.0 |
| 12 | Cutterbar Variator | 1 | 667530.1 | A-667530.1 |
| 13 | Chaff Spreader | 1 | 746508.1 | A-746508.1 |
| 14 | Cleaning 3rd Stage | 1 | 756466.0 | A-756466.0 |
| 15 | Cleaning 1ste Stage | 1 | 644209.0 | A-644209.0 |
| 16 | Hybrid Drive 2nd Stage | 1 | 628792.0 | A-628792.0 |
| 17 | Hybrid Drive 1ste Stage | 1 | 644961.0 | A-644961.0 |
| 22 | Drum Variator | 1 | 667248.0 | A-667248.0 |
| 23 | Drum Drive | 1 | 176442.1 | A-176442.1 |
| 25 | Fan Drive 1ste Stage | 1 | 667957.0 | A-667957.0 |
| 26 | Suction Fan | 1 | 667367.0 | A-667367.0 |
| 27 | Fan Drive 3rd Stage | 1 | 744785.0 | A-744785.0 |
| 28 | Pre - Drum Drive | 1 | 667251.1 | A-667251.1 |
| 29 | Hydraulic Reel Drive | 1 | 829094.0 | A-829094.0 |
| 30 | Straw Spreader | 1 | 539443.0 | A-539443.0 |
| 31 | Hybrid Drive, 2nd Stage | 1 | 744965.0 | A-744965.0 |
| 32 | Radiator Screen 2nd Stage | 1 | 545689.0 | A-545689.0 |
| 34 | Fan Drive | 1 | 628964.1 | A-628964.1 |
| 35 | Suction Blower E - Channel | 1 | 765985.0 | A-765985.0 |
| 36 | Fan Variable Speed Drive 2nd Stage | 1 | 628847.1 | A-628847.1 |

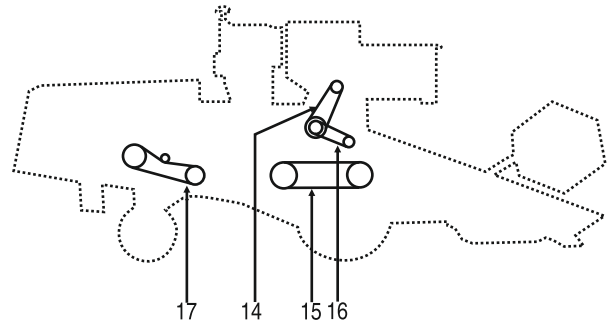
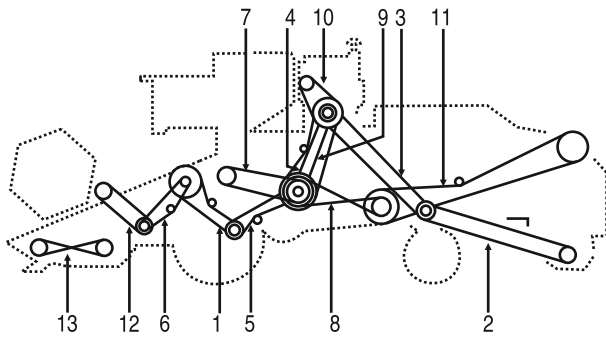

| Belt No. |  | No. of Belts | OEM  Part No. | PIX  Part No. |
|----------|---|--------------|--|--|
| 1 | | 1 | 765985.0 | A-765985.0 |
| 3 | | 3 | 628779.0 | A-628779.0 |
| 4 | | 1 | 744870.0 | A-744870.0 |
| 5 | | 1 | 667249.0 | A-667249.0 |
| 6 | | 1 | 829094.0 | A-829094.0 |
| 7 | | 1 | 644892.0 | A-644892.0 |
| 7 | | 1 | 749859.0 | A-749859.0 |
| 8 | | 1 | 746508.1 | A-746508.1 |
| 9 | | 1 | 644884.0 | A-644884.0 |
| 10 | | 1 | 667981.2 | A-667981.2 |
| 12 | | 1 | 644885.0 | A-644885.0 |
| 13 | | 1 | 644889.0 | A-644889.0 |
| 14 | | 1 | 628978.0 | A-628978.0 |
| 17 | | 1 | 539443.0 | A-539443.0 |
| 18 | | 1 | 644209.0 | A-644209.0 |
| 19 | | 1 | 644902.0 | A-644902.0 |
| 21 | | 1 | 756466.0 | A-756466.0 |
| 40 | | 1 | 628792.0 | A-628792.0 |
| 41 | | 1 | 744965.0 | A-744965.0 |
| 42 | | 1 | 749886.1 | A-749886.1 |
| 47 | | 1 | 667957.0 | A-667957.0 |
| 49 | | 1 | 628847.1 | A-628847.1 |
| 50 | | 1 | 744785.0 | A-744785.0 |
| 52 | | 1 | 744965.0 | A-744965.0 |
| 53 | | 1 | 644965.0 | A-644965.0 |
| 54 | | 1 | 667251.1 | A-667251.1 |
| 60 | | 1 | 744873.0 | A-744873.0 |
| 61 | | 1 | 628964.1 | A-628964.1 |
| 63 | | 1 | 744874.0 | A-744874.0 |



CLAAS MATADOR - STANDARD - GIGANT



| Belt No. |  | No. of Belts | OEM  Part No. | PIX  Part No. |
|----------|---|--------------|--|--|
| 1 | Turning Drum Drive | 1 | 610197.0 | A-610197.0 |
| 2 | Turning Drum Drive | 1 | 500863.0 | A-500863.0 |
| 3 | Countershaft - Baler | 1 | 551068.0 | A-551068.0 |
| 4 | Main Drive | 1 | 630144.0 | A-630144.0 |
| 5 | Radiator Fan Drive | 1 | 610835.0 | A-610835.0 |
| 5 | Radiator Fan Drive | 1 | 610196.0 | A-610196.0 |
| 5 | Radiator Fan Drive | 1 | 653121.0 | A-653121.0 |
| 6 | Knife Drive | 1 | 610833.0 | A-610833.0 |
| 7 | Cylinder | 2 | 617309.0 | A-617309.0 |
| 8 | Sieve Box | 1 | 523252.0 | A-523252.0 |
| 9 | - | 1 | 630043.0 | A-630043.0 |
| 9 | - | 1 | 630025.0 | A-630025.0 |
| 10 | Hydraulic Pump Drive | 1 | 767057.0 | A-767057.0 |
| 11 | Sieve Box | 1 | 772658.0 | A-772658.0 |
| 12 | Reel Drive Variable Speed | 1 | 778561.0 | A-778561.0 |
| 13 | Pick Up Drive | 1 | 800309.0 | A-800309.0 |
| 14 | Drive Grain Tank | 1 | 636021.0 | A-636021.0 |
| 14 | Drive Grain Tank | 1 | 636021.1 | A-636021.1 |
| 15 | Traction Drive | 1 | 630156.0 | A-630156.0 |
| 16 | Drum Drive Variable Speed | 1 | 750294.0 | A-750294.0 |
| 17 | Straw Shaker | 1 | 801222.0 | A-801222.0 |

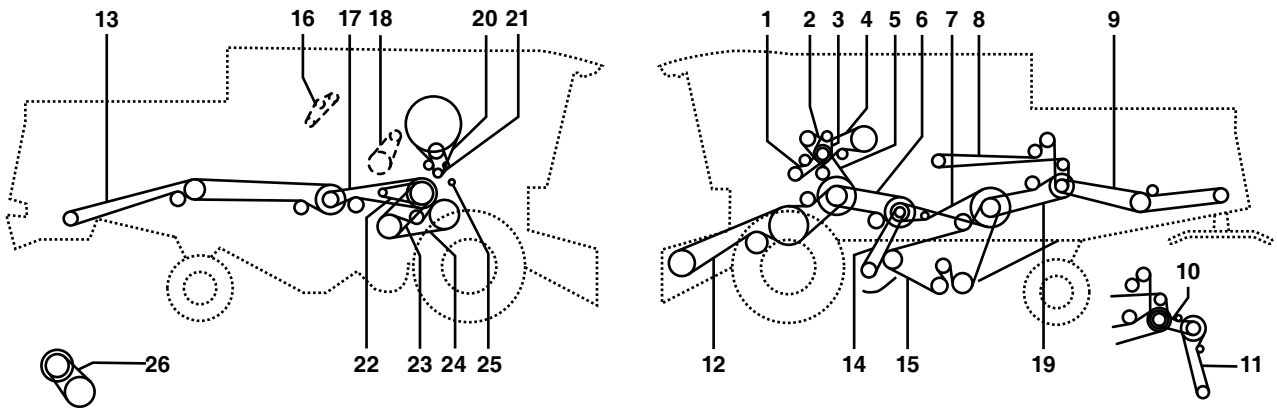

CLAAS MEDION 310 - 320





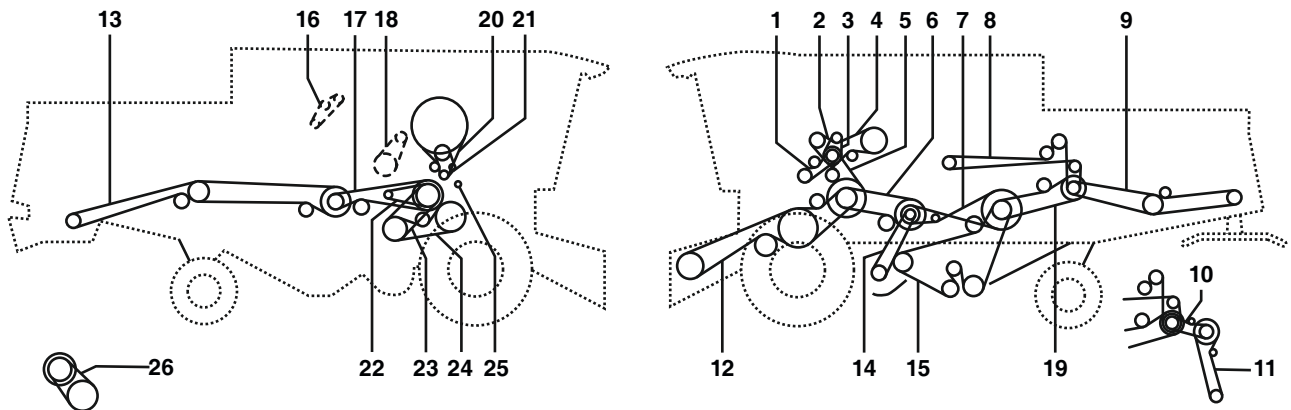

| Belt No. | | No. of Belts | OEM  Part No. | PIX  Part No. |
|----------|---|--------------|--|--|
| 1 | - | 1 | 644016.1 | A-644016.1 |
| 2 | - | 1 | 656028.0 | A-656028.0 |
| 3 | - | 1 | 621903.1 | A-621903.1 |
| 4 | - | 1 | 660409.0 | A-660409.0 |
| 6 | - | 1 | 603337.0 | A-603337.0 |
| 7 | - | 1 | 603336.1 | A-603336.1 |
| 9 | - | 1 | 623427.1 | A-623427.1 |
| 10 | - | 1 | 755070.1 | A-755070.1 |
| 13 | - | 1 | 061214.0 | A-061214.0 |
| 13 | - | 1 | 061353.1 | A-061353.1 |
| 14 | - | 1 | 671209.0 | A-671209.0 |
| 15 | - | 2 | 603017.3 | A-603017.3 |
| 19 | - | 1 | 506671.2 | A-506671.2 |
| 20 | - | 1 | 545689.0 | A-545689.0 |
| 21 | - | 1 | 056961.0 | A-056961.0 |
| 22 | - | 1 | 644448.0 | A-644448.0 |
| 23 | - | 1 | 609823.0 | A-609823.0 |
| 24 | - | 1 | 661220.1 | A-661220.1 |
| 26 | - | 1 | 661429.0 | A-661429.0 |

CLAAS MEDION 330

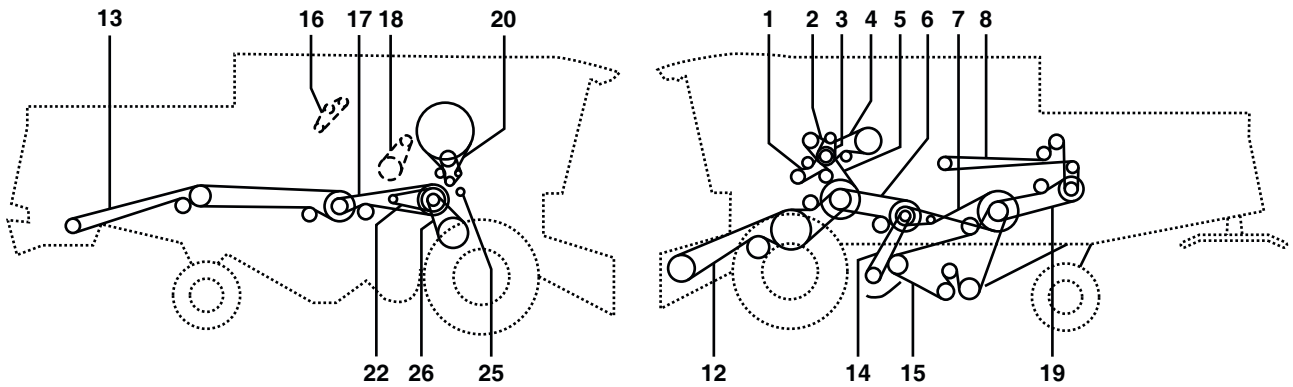



| Belt No. |  | No. of Belts | OEM  Part No. | PIX  Part No. |
|----------|---|--------------|--|--|
| 1 | - | 1 | 644016.1 | A-644016.1 |
| 2 | - | 1 | 656028.0 | A-656028.0 |
| 3 | - | 1 | 621903.1 | A-621903.1 |
| 4 | With Mercedes Om 906 La | 1 | 544166.0 | A-544166.0 |
| 4 | With Perkins 1006-6 Ta | 1 | 660409.0 | A-660409.0 |
| 5 | With Mercedes Om 906 La | 1 | 544164.0 | A-544164.0 |
| 5 | With Perkins 1006-6 Ta | 1 | 544114.1 | A-544114.1 |
| 6 | - | 1 | 603337.0 | A-603337.0 |
| 7 | - | 1 | 603336.1 | A-603336.1 |
| 8 | - | 1 | 644447.0 | A-644447.0 |
| 9 | - | 1 | 623427.1 | A-623427.1 |
| 10 | - | 1 | 755070.1 | A-755070.1 |
| 11 | N = 519 | 1 | 066034.0 | A-066034.0 |
| 11 | N = 660 | 1 | 785341.0 | A-785341.0 |
| 12 | - | 2 | 661301.0 | A-661301.0 |
| 13 | - | 1 | 061353.1 | A-061353.1 |
| 13 | For Corn | 1 | 061214.0 | A-061214.0 |
| 14 | - | 1 | 671209.0 | A-671209.0 |
| 15 | - | 2 | 603017.3 | A-603017.3 |
| 17 | - | 1 | 544147.0 | A-544147.0 |
| 19 | - | 1 | 506671.2 | A-506671.2 |
| 20 | From No. 93202272 | 1 | 821734.2 | A-821734.2 |
| 20 | To No. 93202271 | 1 | 545689.0 | A-545689.0 |
| 21 | - | 1 | 056961.0 | A-056961.0 |
| 22 | - | 1 | 644448.0 | A-644448.0 |
| 23 | - | 1 | 661427.0 | A-661427.0 |
| 24 | Drum Variable Speed Drive | 1 | 661220.1 | A-661220.1 |
| 26 | Direct Drive | 1 | 661429.0 | A-661429.0 |
| 0 | Alternator From No. 93202272 | 1 | 796998.0 | A-796998.0 |
| 0 | Alternator Till Nr. 932002271 | 1 | 545954.0 | A-545954.0 |

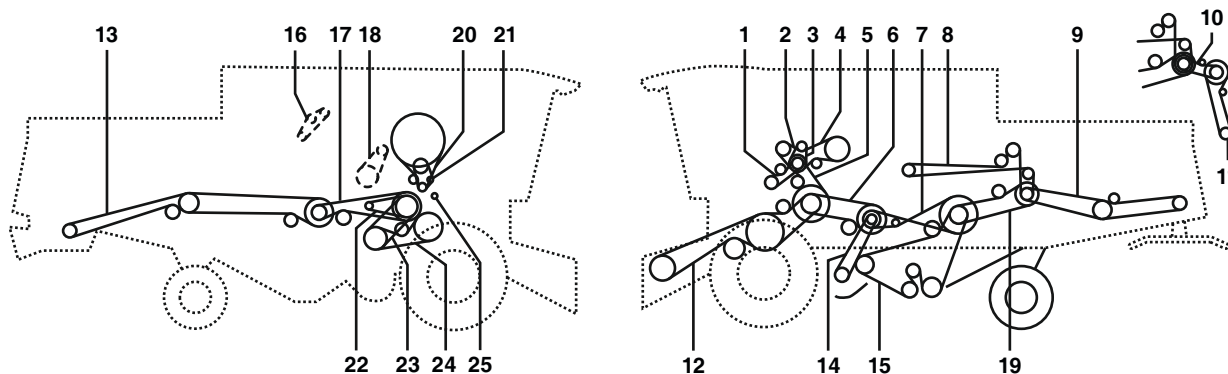

| Belt No. |  | No. of Belts | OEM  Part No. | PIX  Part No. |
|----------|---|--------------|--|--|
| 1 | Hydraulic Ground Drive | 1 | 644016.1 | A-644016.1 |
| 2 | Gear Pump | 1 | 656028.0 | A-656028.0 |
| 3 | Air Conditioner | 1 | 621903.1 | A-621903.1 |
| 4 | Grain Tank Unloading | 1 | 544166.0 | A-544166.0 |
| 5 | Threshing Mechanism Drive | 1 | 544164.0 | A-544164.0 |
| 6 | Sieve Pan, 1ste Stage | 1 | 603337.0 | A-603337.0 |
| 7 | Sieve Pan, 2nd Stage | 1 | 603336.1 | A-603336.1 |
| 8 | Intensive Separation System | 1 | 644447.0 | A-644447.0 |
| 12 | - | 1 | 644419.0 | A-644419.0 |
| 13 | Chopper Drive, 2nd Stage | 1 | 061353.1 | A-061353.1 |
| 14 | Fan Variator | 1 | 671209.0 | A-671209.0 |
| 15 | Sieve Pan, 3rd Stage | 2 | 603017.3 | A-603017.3 |
| 17 | Chopper Drive 1ste Stage | 1 | 544147.0 | A-544147.0 |
| 19 | Straw Walker Drive | 1 | 506671.2 | A-506671.2 |
| 20 | Radiator Screen 2nd Stage From No. 93100144 | 1 | 821734.2 | A-821734.2 |
| 20 | Radiator Screen 2nd Stage To No. 93100143 | 1 | 545689.0 | A-545689.0 |
| 22 | Radiator Screen Suction Blower | 1 | 644448.0 | A-644448.0 |
| 26 | Direct Drive Drum Variable Speed Drive 650-1500 Rpm | 1 | 661429.0 | A-661429.0 |
| 0 | Alternator From No. 93100214 | 1 | 796998.0 | A-796998.0 |
| 0 | Alternator From Nr. 93100213 | 1 | 545954.0 | A-545954.0 |

CLAAS MEDION 340

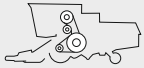

| Belt No. |  | No. of Belts | OEM  Part No. | PIX  Part No. |
|----------|---|--------------|--|--|
| 2 | - | 1 | 656028.0 | A-656028.0 |
| 3 | - | 1 | 621903.1 | A-621903.1 |
| 4 | - | 1 | 544166.0 | A-544166.0 |
| 5 | - | 1 | 544164.0 | A-544164.0 |
| 6 | - | 1 | 603337.0 | A-603337.0 |
| 7 | - | 1 | 644141.1 | A-644141.1 |
| 9 | - | 1 | 623427.1 | A-623427.1 |
| 10 | - | 1 | 755070.1 | A-755070.1 |
| 13 | - | 1 | 061214.0 | A-061214.0 |
| 14 | - | 1 | 603380.1 | A-603380.1 |
| 15 | - | 1 | 609762.0 | A-609762.0 |
| 19 | - | 1 | 506671.2 | A-506671.2 |
| 23 | - | 1 | 609823.0 | A-609823.0 |
| 24 | - | 1 | 661220.1 | A-661220.1 |

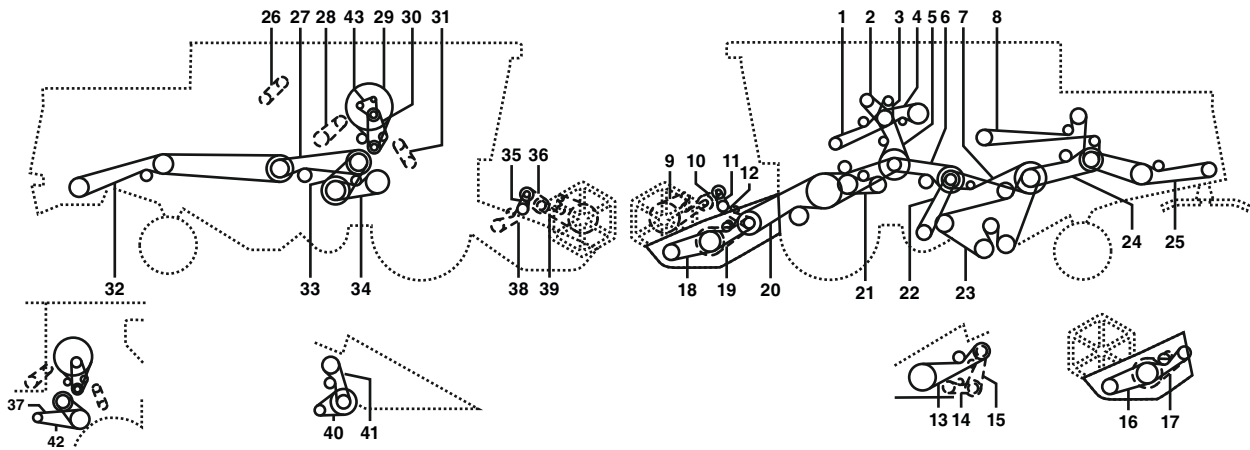

| Belt No. |  | No. of Belts | OEM  Part No. | PIX  Part No. |
|----------|---|--------------|--|--|
| 1 | Ground Drive | 1 | 644465.0 | A-644465.0 |
| 2 | Hydraulic Pump | 1 | 767057.1 | A-767057.1 |
| 3 | Air Conditioner | 1 | 629908.1 | A-629908.1 |
| 4 | Grain Tank | 1 | 629769.0 | A-629769.0 |
| 5 | Threshing Mechanism | 1 | 661458.0 | A-661458.0 |
| 6 | Gear | 1 | 603337.0 | A-603337.0 |
| 7 | - | 1 | 603336.1 | A-603336.1 |
| 8 | Feed Rake Drive | 1 | 644447.0 | A-644447.0 |
| 11 | At 3.6 M - 5.1 M | 1 | 670224.1 | A-670224.1 |
| 13 | For Corn Picker | 1 | 692149.0 | A-692149.0 |
| 13 | For Corn Picker | 1 | 692150.0 | A-692150.0 |
| 16 | At 6.0 M - 6.6 M | 1 | 671013.1 | A-671013.1 |
| 18 | At 3.6 M - 5.1 M | 1 | 713506.2 | A-713506.2 |
| 20 | Shafts Distance 1306mm | 2 | 661337.0 | A-661337.0 |
| 20 | Shafts Distance 1463mm | 2 | 661378.1 | A-661378.1 |
| 21 | Pre - Accelerator | 1 | 661031.0 | A-661031.0 |
| 22 | Fan | 1 | 671209.0 | A-671209.0 |
| 23 | - | 2 | 603017.3 | A-603017.3 |
| 24 | Straw Walker | 1 | 506671.2 | A-506671.2 |
| 25 | Straw Spreader | 1 | 635494.0 | A-635494.0 |
| 27 | Straw Chopper | 1 | 060306.2 | A-060306.2 |
| 29 | Radiator Screen | 1 | 661345.0 | A-661345.0 |
| 30 | Gear | 1 | 657793.0 | A-657793.0 |
| 32 | For Grain Chopper | 1 | 061361.0 | A-061361.0 |
| 32 | For Corn Chopper | 1 | 061213.0 | A-061213.0 |
| 33 | At 2 Stage Drive | 1 | 609823.0 | A-609823.0 |
| 34 | At 2 Stage Drive | 1 | 661220.0 | A-661220.0 |
| 35 | At 6.0 M - 6.6 M | 1 | 670224.1 | A-670224.1 |
| 37 | Suction Fan | 1 | 644448.0 | A-644448.0 |
| 41 | For Hph-g Chopper | 1 | 680334.1 | A-680334.1 |
| 42 | N = 650 - 1500 Min-1 | 1 | 644418.0 | A-644418.0 |
| 43 | At Mercedes Om 366 A | 1 | 133630.1 | A-133630.1 |
| 43 | At Perkins 1006.6 T | 1 | 147233.1 | A-147233.1 |

CLAAS MEGA 202 II

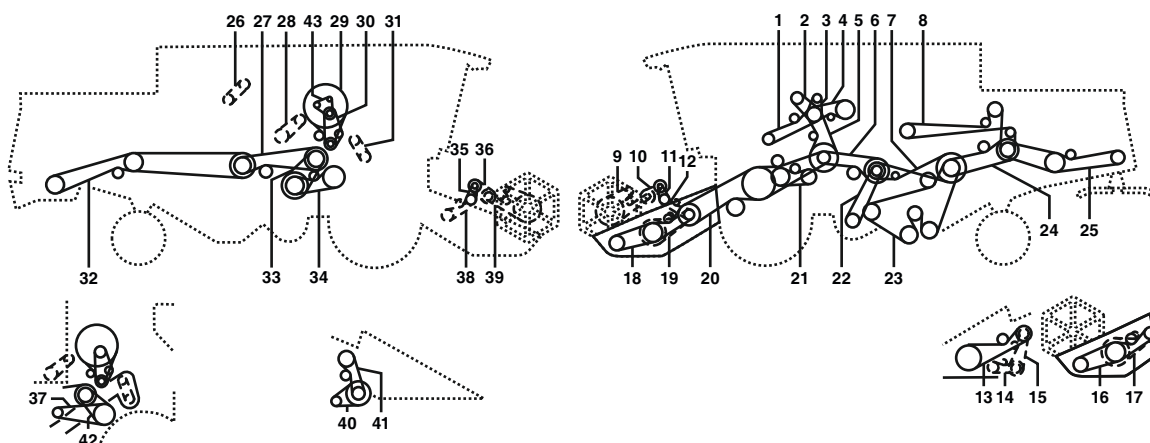

| Belt No. |  | No. of Belts | OEM  Part No. | PIX  Part No. |
|----------|---|--------------|--|--|
| 1 | | 1 | 644465.0 | A-644465.0 |
| 2 | | 1 | 767057.1 | A-767057.1 |
| 3 | | 1 | 629908.1 | A-629908.1 |
| 4 | | 1 | 629769.0 | A-629769.0 |
| 5 | | 1 | 661458.0 | A-661458.0 |
| 6 | | 1 | 603337.0 | A-603337.0 |
| 7 | | 1 | 603336.1 | A-603336.1 |
| 8 | | 1 | 644447.0 | A-644447.0 |
| 11 | | 1 | 670224.1 | A-670224.1 |
| 13 | | 1 | 692149.0 | A-692149.0 |
| 13 | | 1 | 692150.0 | A-692150.0 |
| 16 | | 1 | 671013.1 | A-671013.1 |
| 18 | | 1 | 713506.2 | A-713506.2 |
| 20 | | 2 | 644369.0 | A-644369.0 |
| 21 | | 1 | 661031.1 | A-661031.1 |
| 22 | | 1 | 671209.0 | A-671209.0 |
| 23 | | 2 | 603017.3 | A-603017.3 |
| 24 | | 1 | 506671.2 | A-506671.2 |
| 25 | | 1 | 635494.0 | A-635494.0 |
| 27 | | 1 | 060306.3 | A-060306.3 |
| 29 | | 1 | 661345.0 | A-661345.0 |
| 30 | | 1 | 657793.0 | A-657793.0 |
| 32 | | 1 | 061361.0 | A-061361.0 |
| 32 | | 1 | 061213.0 | A-061213.0 |
| 33 | | 1 | 609823.0 | A-609823.0 |
| 34 | | 1 | 661220.0 | A-661220.0 |
| 35 | | 1 | 670224.1 | A-670224.1 |
| 37 | | 1 | 644448.0 | A-644448.0 |
| 41 | | 1 | 680334.1 | A-680334.1 |
| 42 | | 1 | 644418.0 | A-644418.0 |
| 43 | | 1 | 133630.1 | A-133630.1 |
| 43 | | 1 | 147233.1 | A-147233.1 |

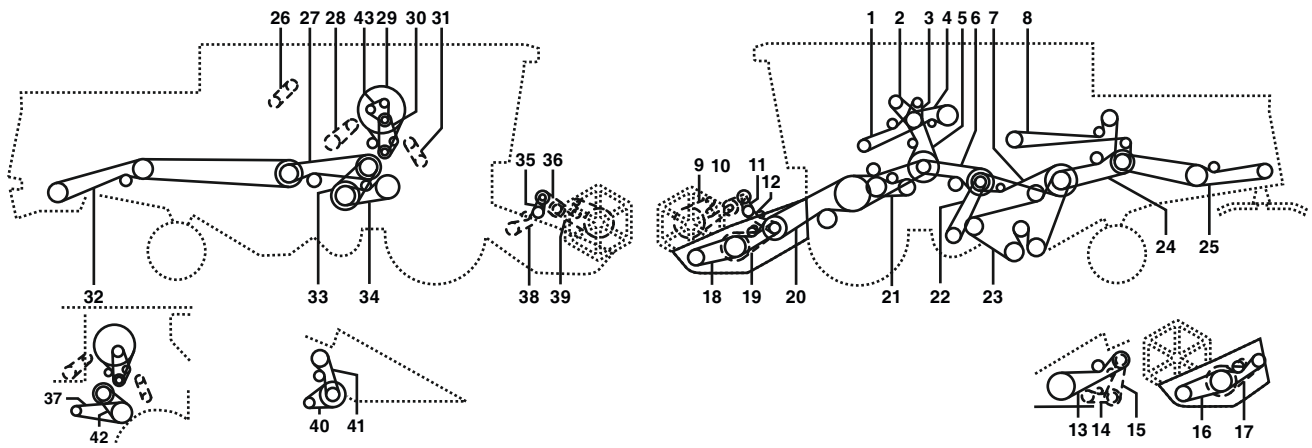

CLAAS MEGA 203

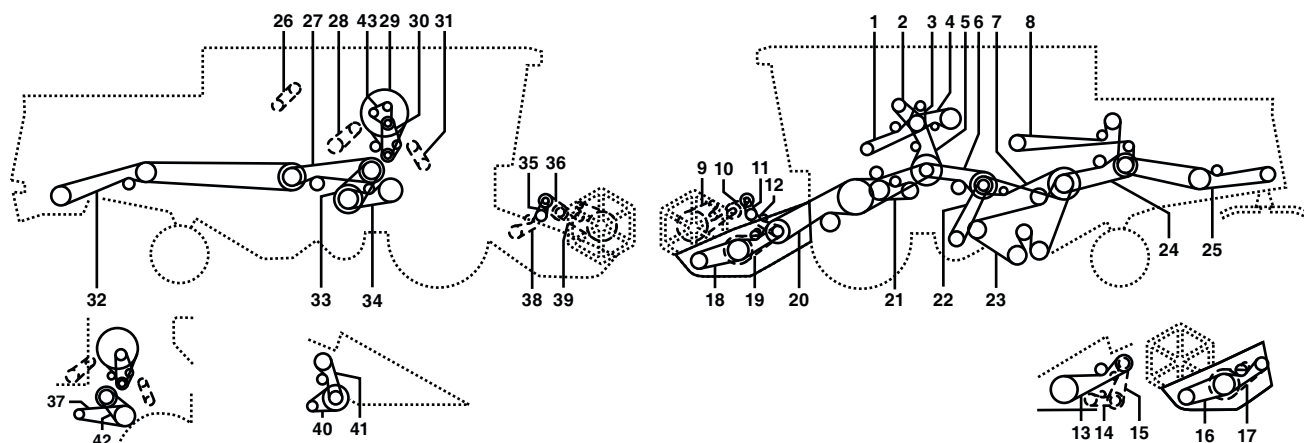

| Belt No. |  | No. of Belts | OEM  Part No. | PIX  Part No. |
|----------|---|--------------|--|--|
| 1 | Ground Drive | 1 | 661362.1 | A-661362.1 |
| 1 | At Mercedes Om 366 La With 163 Kw | 1 | 661451.0 | A-661451.0 |
| 2 | Hydraulic Pump | 1 | 767057.1 | A-767057.1 |
| 3 | Air Conditioner | 1 | 629908.1 | A-629908.1 |
| 4 | Grain Tank | 1 | 629769.0 | A-629769.0 |
| 4 | At Mercedes Om 366 La With 163 Kw | 1 | 660409.0 | A-660409.0 |
| 5 | Threshing Mechanism | 1 | 661458.0 | A-661458.0 |
| 5 | At Mercedes Om 366 La With 163 Kw | 1 | 644404.1 | A-644404.1 |
| 6 | Gear | 1 | 603337.0 | A-603337.0 |
| 7 | - | 1 | 644141.1 | A-644141.1 |
| 7 | - | 1 | 603336.1 | A-603336.1 |
| 8 | Feed Rake Drive | 1 | 644447.0 | A-644447.0 |
| 11 | At 3.9 M - 5.1 M | 1 | 670224.1 | A-670224.1 |
| 13 | For Corn Picker | 1 | 692149.0 | A-692149.0 |
| 13 | For Corn Picker | 1 | 692150.0 | A-692150.0 |
| 13 | For Multimaster | 1 | 629142.0 | A-629142.0 |
| 16 | At 6.0m - 7.5m | 1 | 671013.1 | A-671013.1 |
| 18 | At 3.9 M - 5.1 M | 1 | 713506.2 | A-713506.2 |
| 20 | Shafts Distance 1306 Mm | 2 | 661337.0 | A-661337.0 |
| 20 | Shafts Distance 1463 Mm | 2 | 661378.1 | A-661378.1 |
| 21 | Pre - Accelerator | 1 | 661031.0 | A-661031.0 |
| 22 | Blower - 204 Mega | 1 | 603380.1 | A-603380.1 |
| 22 | Blower - 203 Mega | 1 | 671209.0 | A-671209.0 |
| 23 | Sieve Pan | 1 | 609762.0 | A-609762.0 |
| 23 | Sieve Pan | 2 | 603017.3 | A-603017.3 |
| 24 | Straw Walker | 1 | 506671.2 | A-506671.2 |
| 25 | Straw Spreader | 1 | 623427.1 | A-623427.1 |
| 27 | Straw Chopper | 1 | 060306.2 | A-060306.2 |
| 29 | Radiator Screen | 1 | 661345.0 | A-661345.0 |
| 30 | Gear | 1 | 657793.0 | A-657793.0 |
| 32 | For Grain Chopper From No. 09350552 | 1 | 061353.0 | A-061353.0 |
| 32 | To No. 09350551 | 1 | 061360.0 | A-061360.0 |
| 32 | For Corn Chopper | 1 | 061214.0 | A-061214.0 |
| 33 | At 2 Stage Drive | 1 | 609823.0 | A-609823.0 |
| 34 | At 2 Stage Drive | 1 | 661220.0 | A-661220.0 |
| 35 | At 6.0m - 7.5m | 1 | 670224.1 | A-670224.1 |

CLAAS MEGA 203

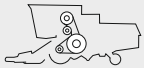

| Belt No. |  | No. of Belts | OEM  Part No. | PIX  Part No. |
|----------|---|--------------|--|--|
| 37 | Suction Fan | 1 | 644448.0 | A-644448.0 |
| 41 | For Hph - G Chopper | 1 | 680334.1 | A-680334.1 |
| 42 | At Dominator 203 Mega With N = 650 - 1500 Min-1 | 1 | 644418.0 | A-644418.0 |
| 43 | At Mercedes Om 366 La | 1 | 133635.1 | A-133635.1 |
| 43 | At Mercedes Om 366 A | 1 | 133630.1 | A-133630.1 |
| 43 | At Perkins 1006.6 T | 1 | 147233.1 | A-147233.1 |

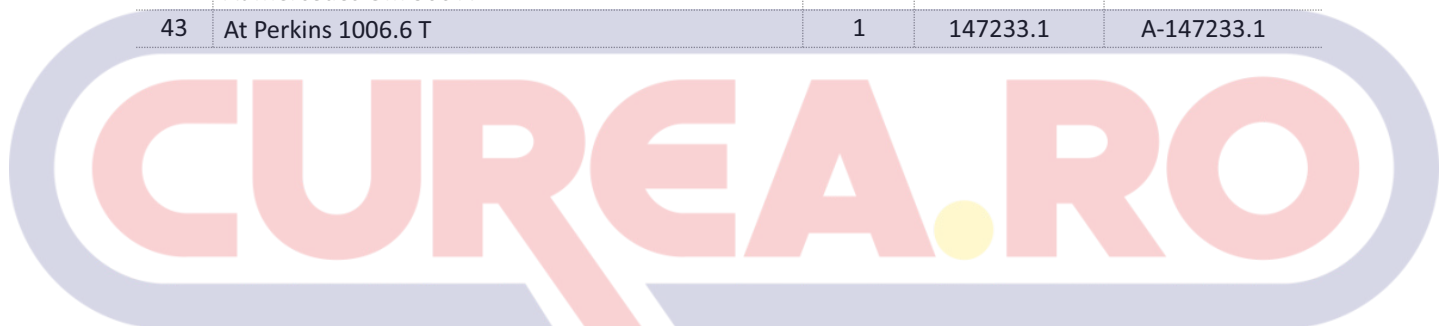



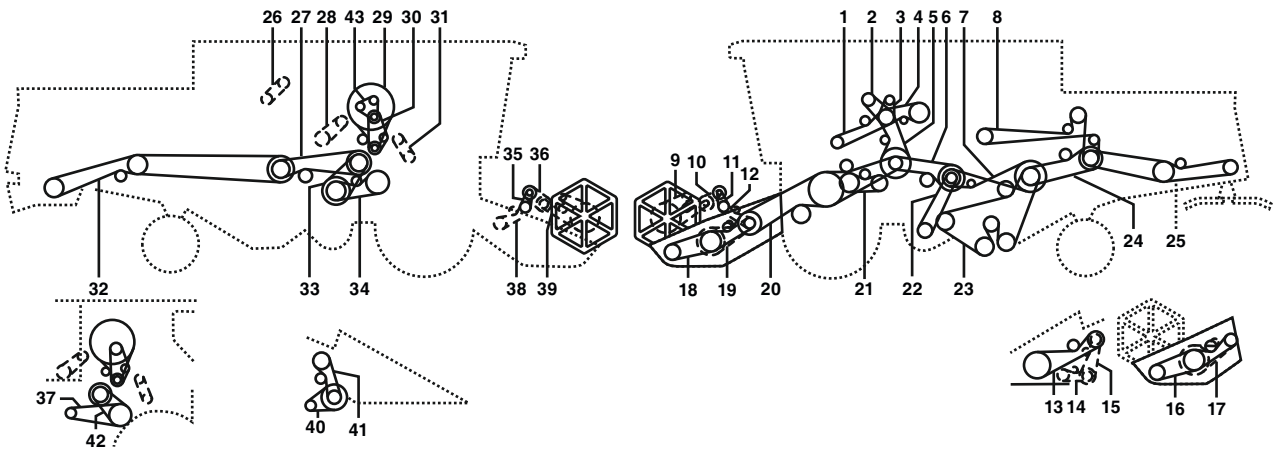

CLAAS MEGA 203 II

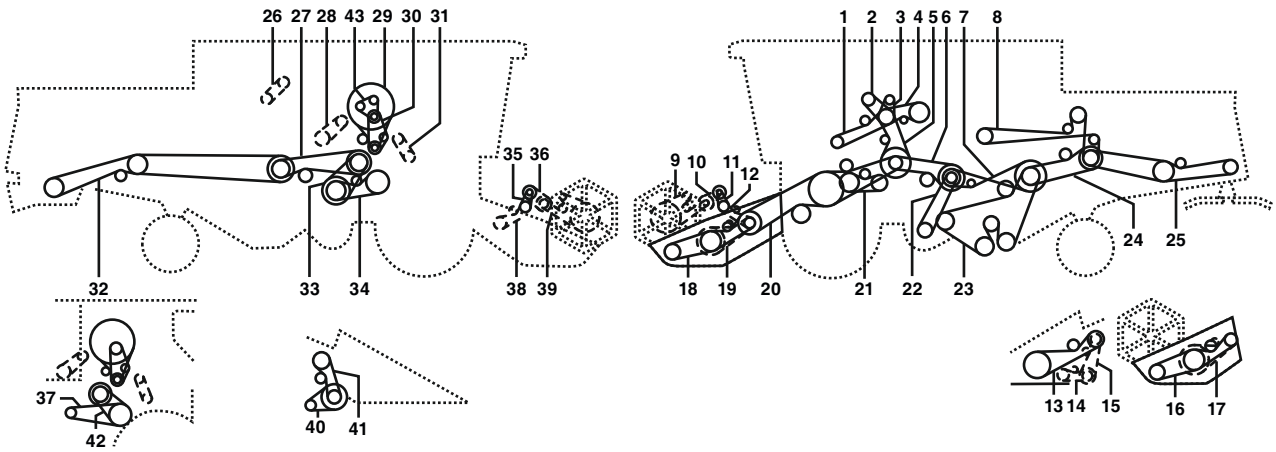

| Belt No. |  | No. of Belts | OEM  Part No. | PIX  Part No. |
|----------|---|--------------|--|--|
| 1 | Ground Drive | 1 | 661362.1 | A-661362.1 |
| 1 | At Mercedes Om 366 La With 163 Kw | 1 | 661451.0 | A-661451.0 |
| 1 | With Mercedes Om 906 La | 1 | 644016.1 | A-644016.1 |
| 2 | Hydraulic Pump | 1 | 767057.1 | A-767057.1 |
| 2 | Hydraulic Pump With Mercedes Om 906 La | 1 | 656028.0 | A-656028.0 |
| 3 | Air Conditioner | 1 | 629908.1 | A-629908.1 |
| 3 | Air Conditioning With Mercedesom 906 La | 1 | 621903.1 | A-621903.1 |
| 4 | Grain Tank | 1 | 629769.1 | A-629769.1 |
| 4 | At Mercedes Om 366 La With 163 Kw | 1 | 660409.0 | A-660409.0 |
| 4 | With Merd | 1 | 544166.0 | A-544166.0 |
| 5 | Threshing Mechanism | 1 | 661458.0 | A-661458.0 |
| 5 | At Mercedes Om 366 La With 163 Kw | 1 | 644404.1 | A-644404.1 |
| 5 | With Mercedes Om 906 La | 1 | 544164.0 | A-544164.0 |
| 6 | Gear | 1 | 603337.0 | A-603337.0 |
| 7 | - | 1 | 603336.1 | A-603336.1 |
| 8 | Feed Rake Drive | 1 | 644447.0 | A-644447.0 |
| 11 | At 3.9 M - 5.1 M | 1 | 670224.1 | A-670224.1 |
| 13 | For Corn Picker | 1 | 692149.0 | A-692149.0 |
| 13 | For Corn Picker | 1 | 692150.0 | A-692150.0 |
| 13 | For Multimaster | 1 | 661362.1 | A-661362.1 |
| 16 | At 6.0m - 7.5m | 1 | 671013.1 | A-671013.1 |
| 18 | At 3.9 M - 5.1 M | 1 | 713506.2 | A-713506.2 |
| 20 | Feeder Channel | 2 | 644369.0 | A-644369.0 |
| 21 | Pre - Accelerator | 1 | 661031.1 | A-661031.1 |
| 22 | Blower - 203 Mega | 1 | 671209.0 | A-671209.0 |
| 23 | Sieve Pan | 2 | 603017.3 | A-603017.3 |
| 24 | Straw Walker | 1 | 506671.2 | A-506671.2 |
| 25 | Straw Spreader | 1 | 623427.1 | A-623427.1 |
| 27 | To No. 93500772 | 1 | 060306.3 | A-060306.3 |
| 27 | Straw Chopper | 1 | 060306.3 | A-060306.3 |
| 29 | Radiator Screen | 1 | 661345.0 | A-661345.0 |
| 29 | Radiator Screen With Mercedes Om 906 La | 1 | 545668.1 | A-545668.1 |
| 30 | Mercedes Om 366 La | 1 | 657793.0 | A-657793.0 |
| 30 | Perkins 1006.6 T | 1 | 657793.0 | A-657793.0 |
| 30 | Mercedes Om 366 La 163 Kw | 1 | 661244.0 | A-661244.0 |
| 30 | With Mercedes Om 906 La | 1 | 545689.0 | A-545689.0 |

CLAAS MEGA 203 II



| Belt No. |  | No. of Belts | OEM  Part No. | PIX  Part No. |
|----------|---|--------------|--|--|
| 32 | Grain | 1 | 061353.1 | A-061353.1 |
| 32 | For Corn - Chopper | 1 | 061214.0 | A-061214.0 |
| 33 | At Dominator 204 Mega With N = 650 - 1500 Min-1 | 1 | 609823.0 | A-609823.0 |
| 33 | At 2 Stage Drive | 1 | 609823.0 | A-609823.0 |
| 34 | At Dominator 204 Mega With N = 650 - 1500 Min-1 | 1 | 661220.1 | A-661220.1 |
| 34 | At 2 Stage Drive | 1 | 661220.1 | A-661220.1 |
| 35 | At 6.0m - 7.5m | 1 | 670224.1 | A-670224.1 |
| 37 | Suction Fan | 1 | 644448.0 | A-644448.0 |
| 41 | For Hph - G Chopper | 1 | 680334.1 | A-680334.1 |
| 42 | At Dominator 203 Mega With N = 650 - 1500 Min-1 | 1 | 644418.0 | A-644418.0 |
| 43 | Mercedes 366 La (147 Kw) | 1 | 133635.1 | A-133635.1 |
| 43 | Mercedes 366 La (163 Kw) | 1 | 133642.0 | A-133642.0 |
| 43 | At Perkins 1006.6 T | 1 | 147233.1 | A-147233.1 |

CLAAS MEGA 204

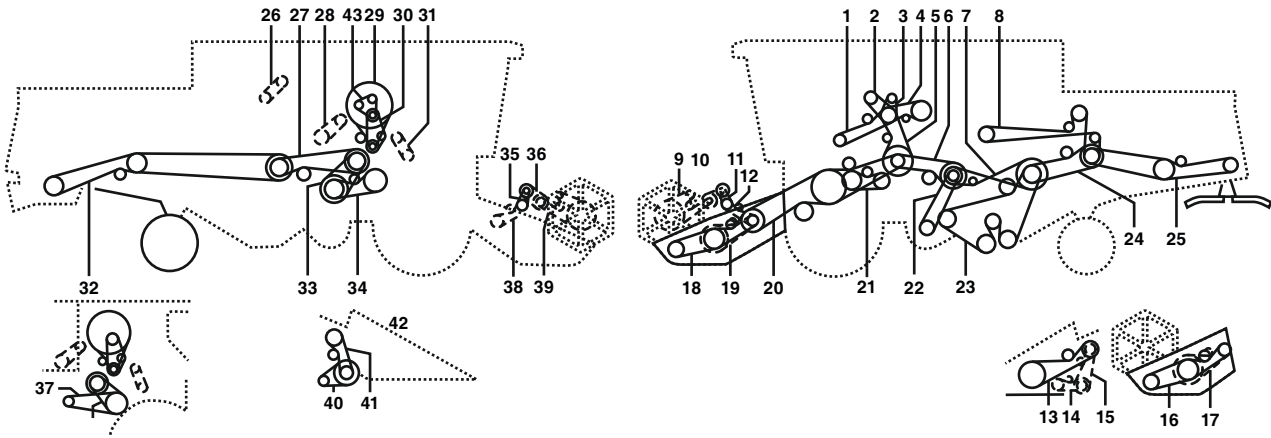



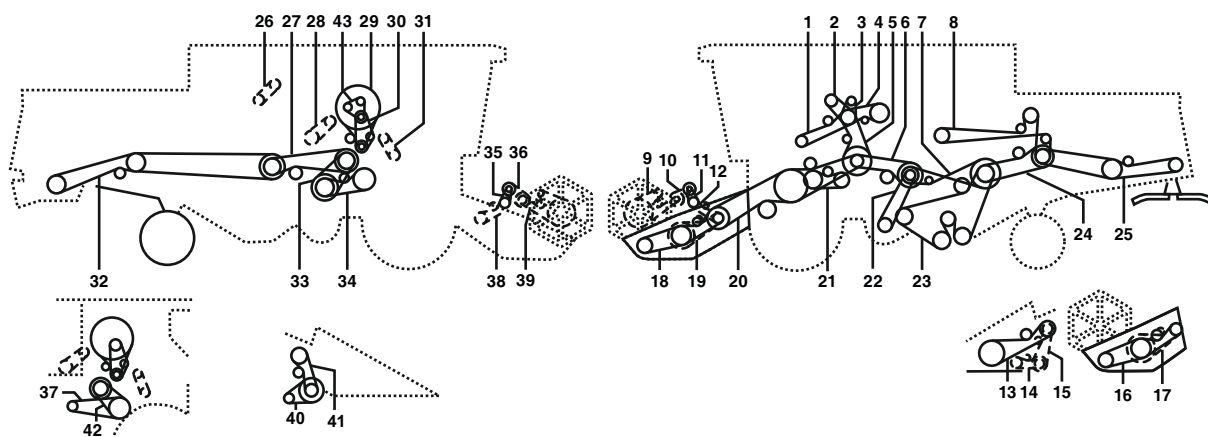

| Belt No. |  | No. of Belts | OEM  Part No. | PIX  Part No. |
|----------|---|--------------|--|--|
| 1 | Ground Drive | 1 | 661362.1 | A-661362.1 |
| 1 | At Mercedes Om 366 La With 163 Kw | 1 | 661451.0 | A-661451.0 |
| 2 | Hydraulic Pump | 1 | 767057.1 | A-767057.1 |
| 3 | Air Conditioner | 1 | 629908.1 | A-629908.1 |
| 4 | Grain Tank | 1 | 629769.0 | A-629769.0 |
| 4 | At Mercedes Om 366 La With 163 Kw | 1 | 660409.0 | A-660409.0 |
| 5 | Threshing Mechanism | 1 | 661458.0 | A-661458.0 |
| 5 | At Mercedes Om 366 La With 163 Kw | 1 | 644404.1 | A-644404.1 |
| 6 | Gear | 1 | 603337.0 | A-603337.0 |
| 7 | Grain Elevator - 204 Mega From No. 09350930 | 1 | 644141.1 | A-644141.1 |
| 8 | Feed Rake Drive | 1 | 644447.0 | A-644447.0 |
| 11 | At 3.9 M - 5.1 M | 1 | 670224.1 | A-670224.1 |
| 13 | For Corn Picker | 1 | 692149.0 | A-692149.0 |
| 13 | For Corn Picker | 1 | 692150.0 | A-692150.0 |
| 13 | For Multimaster | 1 | 629142.0 | A-629142.0 |
| 16 | At 6.0m - 7.5m | 1 | 671013.1 | A-671013.1 |
| 18 | At 3.9 M - 5.1 M | 1 | 713506.2 | A-713506.2 |
| 20 | Shafts Distance 1306 Mm | 2 | 661337.0 | A-661337.0 |
| 20 | Shafts Distance 1463 Mm | 2 | 661378.1 | A-661378.1 |
| 21 | Pre - Accelerator | 1 | 661031.0 | A-661031.0 |
| 22 | Blower - 204 Mega | 1 | 603380.1 | A-603380.1 |
| 23 | Sieve Pan | 1 | 609762.0 | A-609762.0 |
| 24 | Straw Walker | 1 | 506671.2 | A-506671.2 |
| 25 | Straw Spreader | 1 | 623427.1 | A-623427.1 |
| 27 | Straw Chopper | 1 | 060306.2 | A-060306.2 |
| 29 | Radiator Screen | 1 | 661345.0 | A-661345.0 |
| 30 | Gear | 1 | 657793.0 | A-657793.0 |
| 32 | For Grain Chopper From No. 09350552 | 1 | 061353.0 | A-061353.0 |
| 32 | To No. 09350551 | 1 | 061360.0 | A-061360.0 |
| 32 | For Corn Chopper | 1 | 061214.0 | A-061214.0 |
| 33 | At Dominator 204 Mega With N = 650 - 1500 Min-1 | 1 | 609823.0 | A-609823.0 |
| 33 | At 2 Stage Drive | 1 | 609823.0 | A-609823.0 |
| 34 | At Dominator 204 Mega With N = 650 - 1500 Min-1 | 1 | 661220.0 | A-661220.0 |
| 34 | At 2 Stage Drive | 1 | 661220.0 | A-661220.0 |
| 35 | At 6.0m - 7.5m | 1 | 670224.1 | A-670224.1 |
| 37 | Suction Fan | 1 | 644448.0 | A-644448.0 |
| 41 | For Hph - G Chopper | 1 | 680334.1 | A-680334.1 |
| 43 | At Mercedes Om 366 La | 1 | 133635.1 | A-133635.1 |
| 43 | At Mercedes Om 366 A | 1 | 133630.1 | A-133630.1 |
| 43 | At Perkins 1006.6 T | 1 | 147233.1 | A-147233.1 |

CLAAS MEGA 204 II

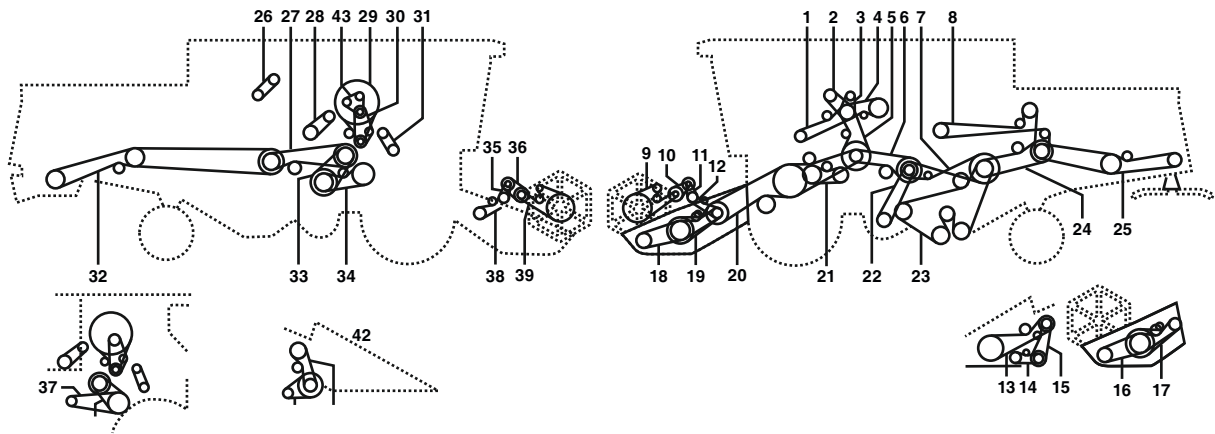

| Belt No. |  | No. of Belts | OEM  Part No. | PIX  Part No. |
|----------|---|--------------|--|--|
| 1 | Ground Drive | 1 | 661362.1 | A-661362.1 |
| 1 | At Mercedes Om 366 La With 163 Kw | 1 | 661451.0 | A-661451.0 |
| 1 | With Mercedes Om 906 La | 1 | 644016.1 | A-644016.1 |
| 2 | Hydraulic Pump | 1 | 767057.1 | A-767057.1 |
| 2 | Hydraulic Pump With Mercedes Om 906 La | 1 | 656028.0 | A-656028.0 |
| 3 | Air Conditioner | 1 | 629908.1 | A-629908.1 |
| 3 | Air Conditioning With Mercedesom 906 La | 1 | 621903.1 | A-621903.1 |
| 4 | Grain Tank | 1 | 629769.1 | A-629769.1 |
| 4 | At Mercedes Om 366 La With 163 Kw | 1 | 660409.0 | A-660409.0 |
| 4 | With Merd | 1 | 544166.0 | A-544166.0 |
| 5 | Threshing Mechanism | 1 | 661458.0 | A-661458.0 |
| 5 | At Mercedes Om 366 La With 163 Kw | 1 | 644404.1 | A-644404.1 |
| 5 | With Mercedes Om 906 La | 1 | 544164.0 | A-544164.0 |
| 6 | Gear | 1 | 603337.0 | A-603337.0 |
| 7 | - | 1 | 644141.1 | A-644141.1 |
| 8 | Feed Rake Drive | 1 | 644447.0 | A-644447.0 |
| 11 | At 3.9 M - 5.1 M | 1 | 670224.1 | A-670224.1 |
| 13 | For Corn Picker | 1 | 692149.0 | A-692149.0 |
| 13 | For Corn Picker | 1 | 692150.0 | A-692150.0 |
| 13 | For Multimaster | 1 | 661362.1 | A-661362.1 |
| 16 | At 6.0m - 7.5m | 1 | 671013.1 | A-671013.1 |
| 18 | At 3.9 M - 5.1 M | 1 | 713506.2 | A-713506.2 |
| 20 | Feeder Channel | 2 | 644369.0 | A-644369.0 |
| 21 | Pre - Accelerator | 1 | 661031.1 | A-661031.1 |
| 22 | Blower - 204 Mega | 1 | 603380.1 | A-603380.1 |
| 23 | Sieve Pan | 1 | 609762.0 | A-609762.0 |
| 24 | Straw Walker | 1 | 506671.2 | A-506671.2 |
| 25 | Straw Spreader | 1 | 623427.1 | A-623427.1 |
| 27 | Straw Chopper | 1 | 644538.0 | A-644538.0 |
| 27 | To No. 93500772 | 1 | 060306.3 | A-060306.3 |
| 29 | Radiator Screen | 1 | 661345.0 | A-661345.0 |
| 29 | Radiator Screen With Mercedes Om 906 La | 1 | 545668.1 | A-545668.1 |
| 30 | Mercedes Om 366 La | 1 | 657793.0 | A-657793.0 |
| 30 | Perkins 1006.6 T | 1 | 657793.0 | A-657793.0 |
| 30 | Mercedes Om 366 La 163 Kw | 1 | 661244.0 | A-661244.0 |
| 30 | With Mercedes Om 906 La | 1 | 545689.0 | A-545689.0 |



| Belt No. |  | No. of Belts | OEM  Part No. | PIX  Part No. |
|----------|---|--------------|--|--|
| 32 | Grain | 1 | 644539.0 | A-644539.0 |
| 32 | Grain | 1 | 061353.1 | A-061353.1 |
| 32 | For Corn - Chopper | 1 | 061214.0 | A-061214.0 |
| 33 | At Dominator 204 Mega With N = 650 - 1500 Min-1 | 1 | 609823.0 | A-609823.0 |
| 33 | At 2 Stage Drive | 1 | 609823.0 | A-609823.0 |
| 34 | At Dominator 204 Mega With N = 650 - 1500 Min-1 | 1 | 661220.1 | A-661220.1 |
| 34 | At 2 Stage Drive | 1 | 661220.1 | A-661220.1 |
| 35 | At 6.0m - 7.5m | 1 | 670224.1 | A-670224.1 |
| 37 | Suction Fan | 1 | 644448.0 | A-644448.0 |
| 41 | For Hph - G Chopper | 1 | 680334.1 | A-680334.1 |
| 43 | Mercedes 366 La (147 Kw) | 1 | 133635.1 | A-133635.1 |
| 43 | Mercedes 366 La (163 Kw) | 1 | 133642.0 | A-133642.0 |
| 43 | At Perkins 1006.6 T | 1 | 147233.1 | A-147233.1 |

CLAAS MEGA 208

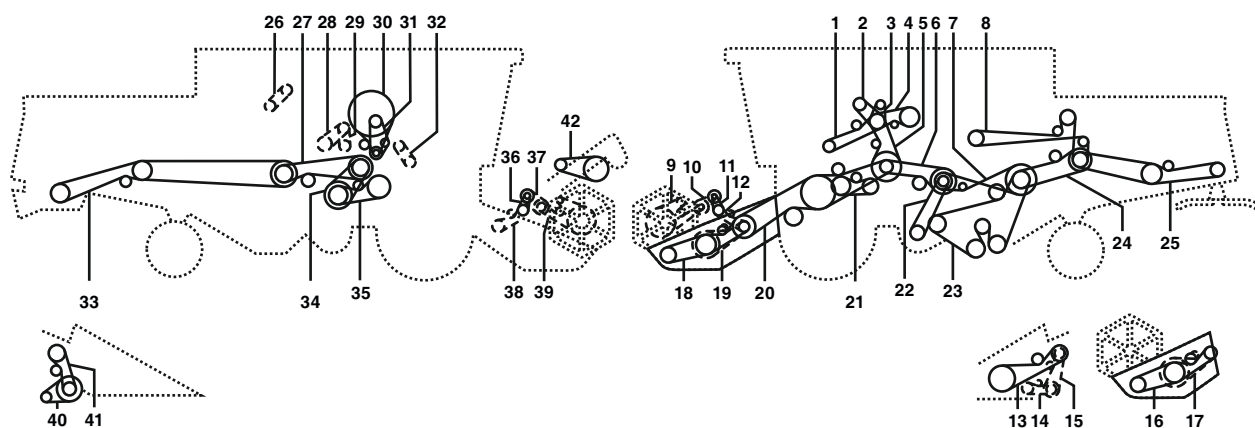

| Belt No. |  | No. of Belts | OEM  Part No. | PIX  Part No. |
|----------|---|--------------|--|--|
| 1 | | 1 | 661239.1 | A-661239.1 |
| 1 | | 1 | 661451.0 | A-661451.0 |
| 2 | | 1 | 633030.2 | A-633030.2 |
| 2 | | 1 | 767057.1 | A-767057.1 |
| 3 | | 1 | 661114.0 | A-661114.0 |
| 3 | | 1 | 629908.1 | A-629908.1 |
| 4 | | 1 | 661093.0 | A-661093.0 |
| 4 | | 1 | 660409.0 | A-660409.0 |
| 5 | | 1 | 644403.0 | A-644403.0 |
| 5 | | 1 | 644404.1 | A-644404.1 |
| 6 | | 1 | 603337.0 | A-603337.0 |
| 7 | | 1 | 644141.1 | A-644141.1 |
| 8 | | 1 | 644447.0 | A-644447.0 |
| 11 | | 1 | 670224.1 | A-670224.1 |
| 13 | | 1 | 692149.0 | A-692149.0 |
| 13 | | 1 | 692150.0 | A-692150.0 |
| 13 | | 1 | 629142.0 | A-629142.0 |
| 16 | | 1 | 671013.1 | A-671013.1 |
| 18 | | 1 | 713506.2 | A-713506.2 |
| 20 | | 2 | 661378.1 | A-661378.1 |
| 20 | | 2 | 644399.0 | A-644399.0 |
| 21 | | 1 | 661031.0 | A-661031.0 |
| 22 | | 1 | 603380.1 | A-603380.1 |
| 23 | | 1 | 609762.0 | A-609762.0 |
| 24 | | 1 | 506671.2 | A-506671.2 |
| 25 | | 1 | 623427.1 | A-623427.1 |
| 27 | | 1 | 060306.3 | A-060306.3 |
| 30 | | 1 | 661345.0 | A-661345.0 |
| 31 | | 1 | 661245.0 | A-661245.0 |
| 31 | | 1 | 661244.0 | A-661244.0 |
| 33 | | 1 | 061353.1 | A-061353.1 |
| 33 | | 1 | 061214.0 | A-061214.0 |
| 34 | | 1 | 609823.0 | A-609823.0 |
| 35 | | 1 | 661220.0 | A-661220.0 |
| 35 | | 1 | 661298.0 | A-661298.0 |
| 35 | | 1 | 661220.0 | A-661220.0 |
| 36 | | 1 | 670224.1 | A-670224.1 |
| 41 | | 1 | 680334.1 | A-680334.1 |
| 42 | | 1 | 644448.0 | A-644448.0 |

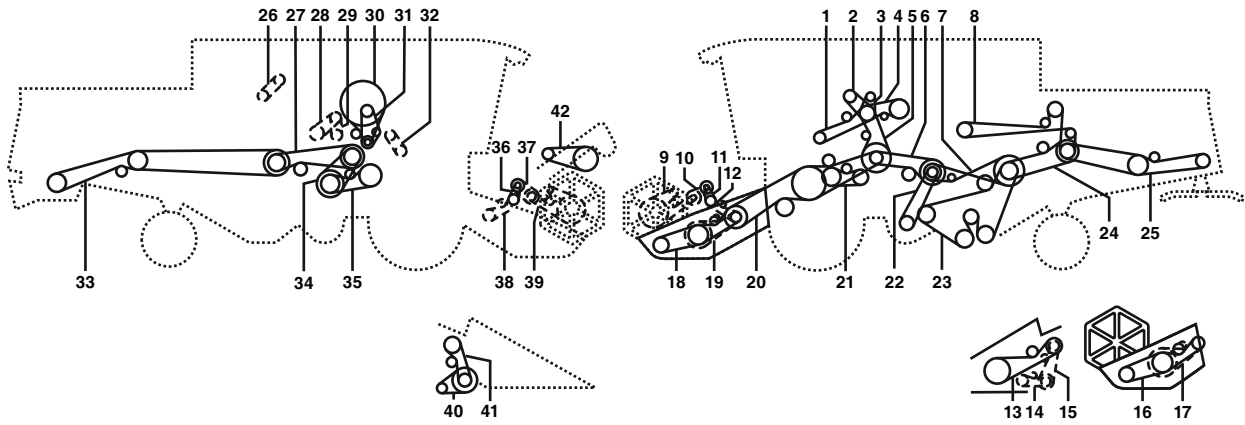

| Belt No. | | No. of Belts | OEM  Part No. | PIX  Part No. |
|----------|--------------------------------------|--------------|--|--|
| 1 | Om 441 A Ground Drive | 1 | 661239.1 | A-661239.1 |
| 1 | Om 366 La Ground Drive | 1 | 661451.0 | A-661451.0 |
| 2 | Om 441 A Hydraulic Pump | 1 | 633030.2 | A-633030.2 |
| 2 | Om 366 La Hydraulic Pump | 1 | 767057.1 | A-767057.1 |
| 3 | Om 441 A Air Conditioning | 1 | 661114.0 | A-661114.0 |
| 3 | Om 366 La Air Conditioning | 1 | 629908.1 | A-629908.1 |
| 4 | Om 441 A Grain Tank | 1 | 661093.0 | A-661093.0 |
| 4 | Om 366 La Grain Tank | 1 | 660409.0 | A-660409.0 |
| 5 | Om 441 A Threshing Mechanism | 1 | 644403.0 | A-644403.0 |
| 5 | Om 366 La Threshing Mechanism | 1 | 644404.1 | A-644404.1 |
| 6 | Gear | 1 | 603337.0 | A-603337.0 |
| 7 | Thank You Gates | 1 | 644141.1 | A-644141.1 |
| 8 | Feed Rake Drive | 1 | 644447.0 | A-644447.0 |
| 11 | At 4.5m - 5.1m | 1 | 670224.1 | A-670224.1 |
| 13 | For Corn Picker | 1 | 692149.0 | A-692149.0 |
| 13 | For Corn Picker | 1 | 692150.0 | A-692150.0 |
| 13 | For Multimaster | 1 | 629142.0 | A-629142.0 |
| 16 | At 6.0 M - 9.0 M | 1 | 671013.1 | A-671013.1 |
| 18 | At 4.5m - 5.1m | 1 | 713506.2 | A-713506.2 |
| 20 | Feeder Channel | 2 | 644368.0 | A-644368.0 |
| 21 | Accelerator | 1 | 661031.1 | A-661031.1 |
| 22 | Fan | 1 | 603380.1 | A-603380.1 |
| 23 | Sieve Box | 1 | 609762.0 | A-609762.0 |
| 24 | Straw Walker | 1 | 506671.2 | A-506671.2 |
| 25 | Straw Spreader | 1 | 623427.1 | A-623427.1 |
| 27 | Straw Chopper From No. 94501059 | 1 | 644538.0 | A-644538.0 |
| 27 | To No. 94501058 | 1 | 060306.3 | A-060306.3 |
| 30 | Radiator Screen | 1 | 661345.0 | A-661345.0 |
| 31 | Om 441 A Intermediate Drive | 1 | 661245.0 | A-661245.0 |
| 31 | Om 366 La Intermediate Drive | 1 | 661244.0 | A-661244.0 |
| 33 | For Grain Chopper From No. 94501059 | 1 | 644539.0 | A-644539.0 |
| 33 | For Grain Chopper To No. 94501058 | 1 | 061353.1 | A-061353.1 |
| 33 | For Corn Chopper | 1 | 061214.0 | A-061214.0 |
| 34 | Drum Gear | 1 | 609823.0 | A-609823.0 |
| 35 | Drum Drive | 1 | 661220.1 | A-661220.1 |
| 36 | At 6.0 M - 9.0 M | 1 | 670224.1 | A-670224.1 |
| 41 | For Hph - G Chopper | 1 | 680334.1 | A-680334.1 |
| 42 | For Suction Blower From No. 94501059 | 1 | 644537.0 | A-644537.0 |
| 42 | To No. 94501058 | 1 | 644448.0 | A-644448.0 |

CLAAS MEGA 218

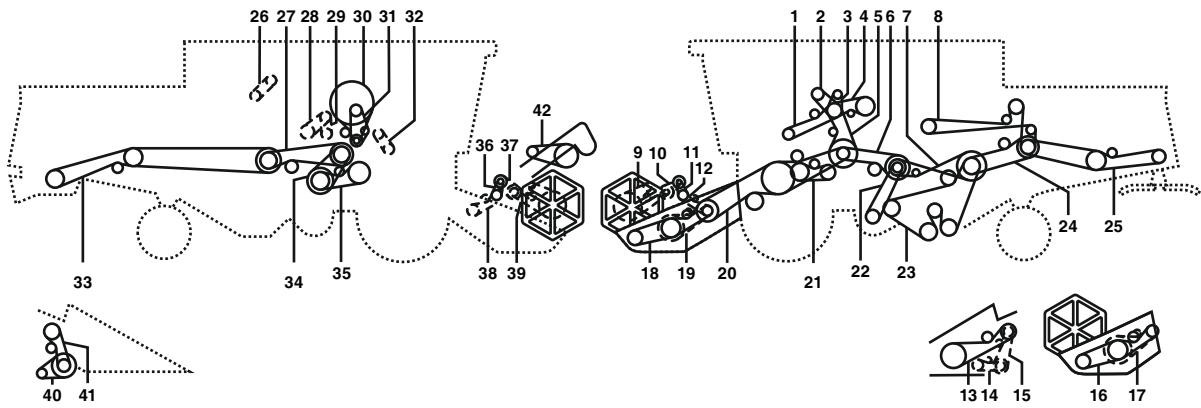



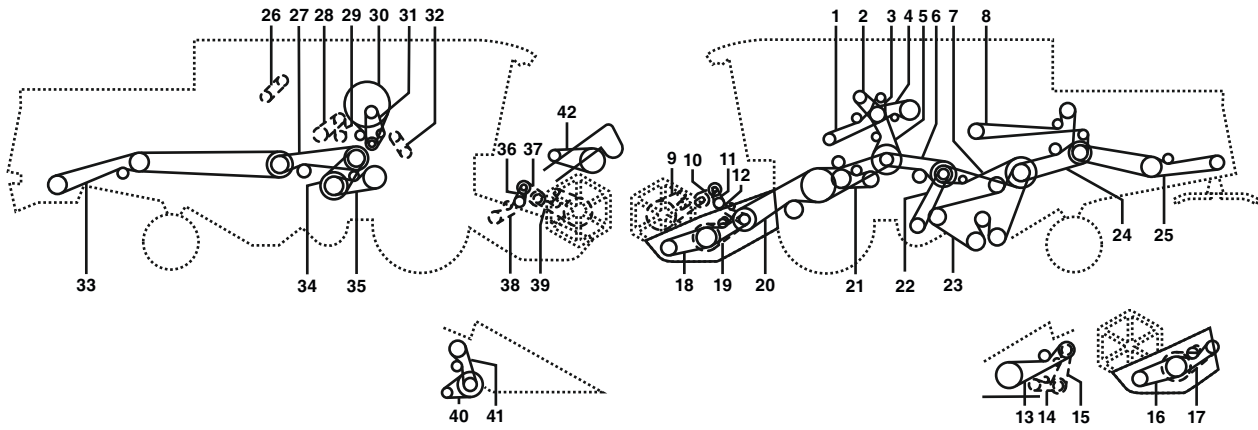

| Belt No. |  | No. of Belts | OEM  Part No. | PIX  Part No. |
|----------|---|--------------|--|--|
| 1 | | 1 | 661239.1 | A-661239.1 |
| 1 | | 1 | 661451.0 | A-661451.0 |
| 2 | | 1 | 633030.2 | A-633030.2 |
| 2 | | 1 | 767057.1 | A-767057.1 |
| 3 | | 1 | 629908.1 | A-629908.1 |
| 3 | | 1 | 661114.0 | A-661114.0 |
| 4 | | 1 | 661093.0 | A-661093.0 |
| 4 | | 1 | 660409.0 | A-660409.0 |
| 5 | | 1 | 644404.1 | A-644404.1 |
| 5 | | 1 | 644403.0 | A-644403.0 |
| 6 | | 1 | 603337.0 | A-603337.0 |
| 7 | | 1 | 644141.1 | A-644141.1 |
| 8 | | 1 | 644447.0 | A-644447.0 |
| 11 | | 1 | 670224.1 | A-670224.1 |
| 13 | | 1 | 692149.0 | A-692149.0 |
| 13 | | 1 | 692150.0 | A-692150.0 |
| 13 | | 1 | 629142.0 | A-629142.0 |
| 16 | | 1 | 671013.1 | A-671013.1 |
| 18 | | 1 | 713506.2 | A-713506.2 |
| 20 | | 2 | 661378.1 | A-661378.1 |
| 20 | | 2 | 644399.0 | A-644399.0 |
| 21 | | 1 | 661031.0 | A-661031.0 |
| 22 | | 1 | 603380.1 | A-603380.1 |
| 23 | | 1 | 609762.0 | A-609762.0 |
| 24 | | 1 | 506671.2 | A-506671.2 |
| 25 | | 1 | 623427.1 | A-623427.1 |
| 27 | | 1 | 060306.3 | A-060306.3 |
| 30 | | 1 | 661345.0 | A-661345.0 |
| 31 | | 1 | 661245.0 | A-661245.0 |
| 31 | | 1 | 661244.0 | A-661244.0 |
| 33 | | 1 | 061353.1 | A-061353.1 |
| 33 | | 1 | 061214.0 | A-061214.0 |
| 34 | | 1 | 609823.0 | A-609823.0 |
| 35 | | 1 | 661220.0 | A-661220.0 |
| 35 | | 1 | 661298.0 | A-661298.0 |
| 35 | | 1 | 661220.0 | A-661220.0 |
| 36 | | 1 | 670224.1 | A-670224.1 |
| 41 | | 1 | 680334.1 | A-680334.1 |
| 42 | | 1 | 644448.0 | A-644448.0 |

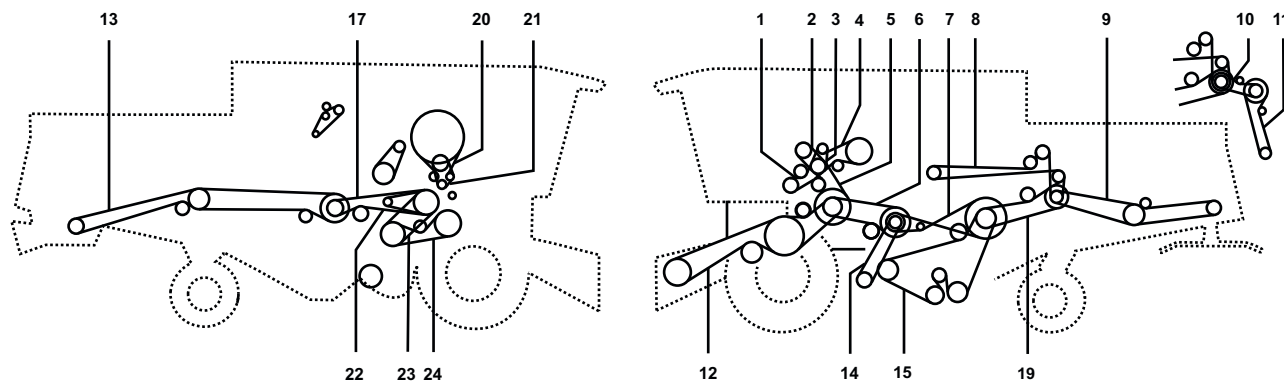

| Belt No. |  | No. of Belts | OEM  Part No. | PIX  Part No. |
|----------|---|--------------|--|--|
| 1 | | 1 | 661239.1 | A-661239.1 |
| 1 | | 1 | 661451.0 | A-661451.0 |
| 2 | | 1 | 633030.2 | A-633030.2 |
| 2 | | 1 | 767057.1 | A-767057.1 |
| 3 | | 1 | 629908.1 | A-629908.1 |
| 3 | | 1 | 661114.0 | A-661114.0 |
| 4 | | 1 | 661093.0 | A-661093.0 |
| 4 | | 1 | 660409.0 | A-660409.0 |
| 5 | | 1 | 644404.1 | A-644404.1 |
| 5 | | 1 | 644403.0 | A-644403.0 |
| 6 | | 1 | 603337.0 | A-603337.0 |
| 7 | | 1 | 644141.1 | A-644141.1 |
| 8 | | 1 | 644447.0 | A-644447.0 |
| 11 | | 1 | 670224.1 | A-670224.1 |
| 13 | | 1 | 692149.0 | A-692149.0 |
| 13 | | 1 | 692150.0 | A-692150.0 |
| 13 | | 1 | 629142.0 | A-629142.0 |
| 16 | | 1 | 671013.1 | A-671013.1 |
| 18 | | 1 | 713506.2 | A-713506.2 |
| 20 | | 2 | 644368.0 | A-644368.0 |
| 21 | | 1 | 661031.1 | A-661031.1 |
| 22 | | 1 | 603380.1 | A-603380.1 |
| 23 | | 1 | 609762.0 | A-609762.0 |
| 24 | | 1 | 506671.2 | A-506671.2 |
| 25 | | 1 | 623427.1 | A-623427.1 |
| 27 | | 1 | 644538.0 | A-644538.0 |
| 27 | | 1 | 060306.3 | A-060306.3 |
| 30 | | 1 | 661345.0 | A-661345.0 |
| 31 | | 1 | 661245.0 | A-661245.0 |
| 31 | | 1 | 661244.0 | A-661244.0 |
| 33 | | 1 | 644539.0 | A-644539.0 |
| 33 | | 1 | 061353.1 | A-061353.1 |
| 33 | | 1 | 061214.0 | A-061214.0 |
| 34 | | 1 | 609823.0 | A-609823.0 |
| 35 | | 1 | 661220.1 | A-661220.1 |
| 36 | | 1 | 670224.1 | A-670224.1 |
| 41 | | 1 | 680334.1 | A-680334.1 |
| 42 | | 1 | 644448.0 | A-644448.0 |
| 42 | | 1 | 644537.0 | A-644537.0 |



CLAAS MEGA 350



| Belt No. |  | No. of Belts | OEM  Part No. | PIX  Part No. |
|----------|---|--------------|--|--|
| 1 | - | 1 | 644016.1 | A-644016.1 |
| 2 | - | 1 | 656028.0 | A-656028.0 |
| 2 | For Threshing | 1 | 629002.1 | A-629002.1 |
| 3 | - | 1 | 621903.1 | A-621903.1 |
| 4 | - | 1 | 544166.0 | A-544166.0 |
| 5 | - | 1 | 544164.0 | A-544164.0 |
| 6 | - | 1 | 603337.0 | A-603337.0 |
| 6 | For Threshing | 1 | 667238.0 | A-667238.0 |
| 7 | - | 1 | 644141.1 | A-644141.1 |
| 8 | - | 1 | 644447.0 | A-644447.0 |
| 9 | - | 1 | 623427.1 | A-623427.1 |
| 10 | - | 1 | 755070.1 | A-755070.1 |
| 11 | For N=519 Rpm | 1 | 066034.0 | A-066034.0 |
| 11 | For N=660 Rpm | 1 | 785341.0 | A-785341.0 |
| 12 | - | 1 | 644369.0 | A-644369.0 |
| 13 | - | 1 | 644539.0 | A-644539.0 |
| 14 | - | 1 | 603380.1 | A-603380.1 |
| 15 | - | 1 | 609762.0 | A-609762.0 |
| 17 | - | 1 | 644538.0 | A-644538.0 |
| 19 | - | 1 | 506671.2 | A-506671.2 |
| 20 | - | 1 | 545689.0 | A-545689.0 |
| 21 | - | 1 | 545668.1 | A-545668.1 |
| 22 | - | 1 | 644537.0 | A-644537.0 |
| 23 | Two Stage Drive | 1 | 661427.0 | A-661427.0 |
| 24 | Drum Drive Variable Speed (n=650-1500 Rpm) | 1 | 661220.1 | A-661220.1 |

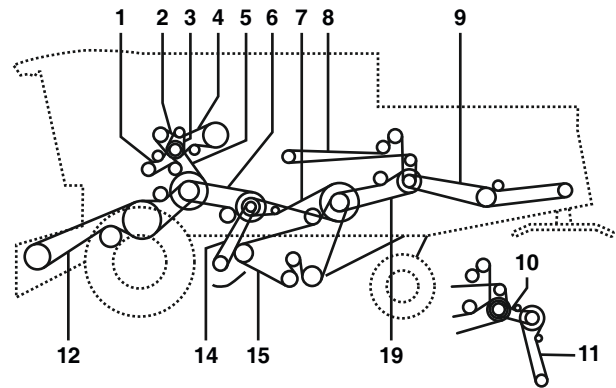
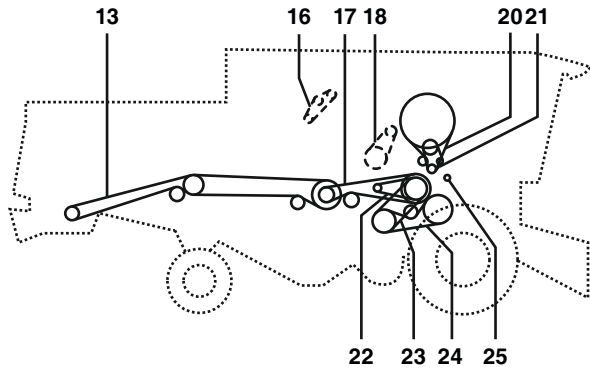

CLAAS MEGA 350 TYP 835



| Belt No. |  | No. of Belts | OEM  Part No. | PIX  Part No. |
|----------|---|--------------|--|--|
| 1 | - | 1 | 644016.1 | A-644016.1 |
| 2 | - | 1 | 656028.0 | A-656028.0 |
| 2 | WHEN THRESHING | 1 | 629002.1 | A-629002.1 |
| 3 | - | 1 | 621903.1 | A-621903.1 |
| 4 | - | 1 | 544166.0 | A-544166.0 |
| 5 | - | 1 | 544164.0 | A-544164.0 |
| 6 | - | 1 | 603337.0 | A-603337.0 |
| 6 | WHEN THRESHING | 1 | 667238.0 | A-667238.0 |
| 7 | - | 1 | 644141.1 | A-644141.1 |
| 8 | - | 1 | 644447.0 | A-644447.0 |
| 9 | - | 1 | 623427.1 | A-623427.1 |
| 10 | - | 1 | 755070.1 | A-755070.1 |
| 11 | N = 519 | 1 | 066034.0 | A-066034.0 |
| 11 | N = 660 | 1 | 785341.0 | A-785341.0 |
| 12 | - | 1 | 644369.0 | A-644369.0 |
| 13 | - | 1 | 544172.0 | A-544172.0 |
| 14 | - | 1 | 603380.1 | A-603380.1 |
| 15 | - | 1 | 609762.0 | A-609762.0 |
| 17 | - | 1 | 644538.0 | A-644538.0 |
| 19 | - | 1 | 506671.2 | A-506671.2 |
| 20 | FROM NO. 83500256 | 1 | 821734.2 | A-821734.2 |
| 20 | TO NO. 83500255 | 1 | 545689.0 | A-545689.0 |
| 21 | TO NO. 83500255 | 1 | 545668.1 | A-545668.1 |
| 22 | - | 1 | 644537.0 | A-644537.0 |
| 23 | TWO STAGE DRIVE | 1 | 661427.0 | A-661427.0 |
| 24 | DRUM VARIABLE SPEED N = 650 - 1500 | 1 | 661220.1 | A-661220.1 |
| 0 | ALTERNATOR FROM NO. 83500256 | 1 | 796998.0 | A-796998.0 |
| 0 | ALTERNATOR FROM NR. 83500255 | 1 | 545954.0 | A-545954.0 |

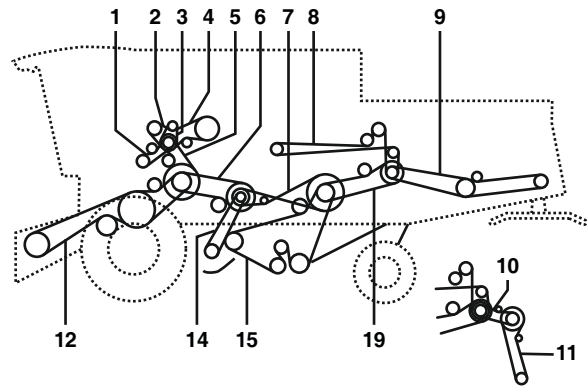
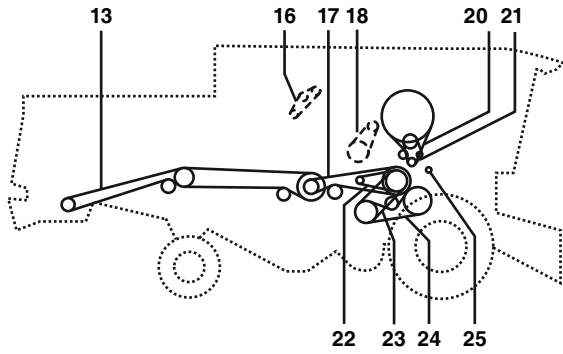

CLAAS MEGA 350 TYP 836



| Belt No. |  | No. of Belts | OEM  Part No. | PIX  Part No. |
|----------|---|--------------|--|--|
| 1 | - | 1 | 644016.1 | A-644016.1 |
| 2 | - | 1 | 656028.0 | A-656028.0 |
| 2 | When Threshing | 1 | 629002.1 | A-629002.1 |
| 3 | - | 1 | 621903.1 | A-621903.1 |
| 4 | - | 1 | 544166.0 | A-544166.0 |
| 5 | - | 1 | 544164.0 | A-544164.0 |
| 6 | - | 1 | 603337.0 | A-603337.0 |
| 6 | When Threshing | 1 | 667238.0 | A-667238.0 |
| 7 | - | 1 | 644141.1 | A-644141.1 |
| 8 | - | 1 | 644447.0 | A-644447.0 |
| 9 | - | 1 | 623427.1 | A-623427.1 |
| 10 | - | 1 | 755070.1 | A-755070.1 |
| 11 | N = 519 | 1 | 066034.0 | A-066034.0 |
| 11 | N = 660 | 1 | 785341.0 | A-785341.0 |
| 12 | - | 1 | 644369.0 | A-644369.0 |
| 13 | - | 1 | 544172.0 | A-544172.0 |
| 14 | - | 1 | 603380.1 | A-603380.1 |
| 15 | - | 1 | 609762.0 | A-609762.0 |
| 17 | - | 1 | 644538.0 | A-644538.0 |
| 19 | - | 1 | 506671.2 | A-506671.2 |
| 20 | From No. 83500256 | 1 | 821734.2 | A-821734.2 |
| 20 | To No. 83500255 | 1 | 545689.0 | A-545689.0 |
| 21 | To No. 83500255 | 1 | 545668.1 | A-545668.1 |
| 22 | - | 1 | 644537.0 | A-644537.0 |
| 23 | Two Stage Drive | 1 | 661427.0 | A-661427.0 |
| 24 | Drum Variable Speed Drive N = 650 - 1500 | 1 | 661220.1 | A-661220.1 |
| 0 | Alternator From No. 83500256 | 1 | 796998.0 | A-796998.0 |
| 0 | Alternator From Nr. 83500255 | 1 | 545954.0 | A-545954.0 |

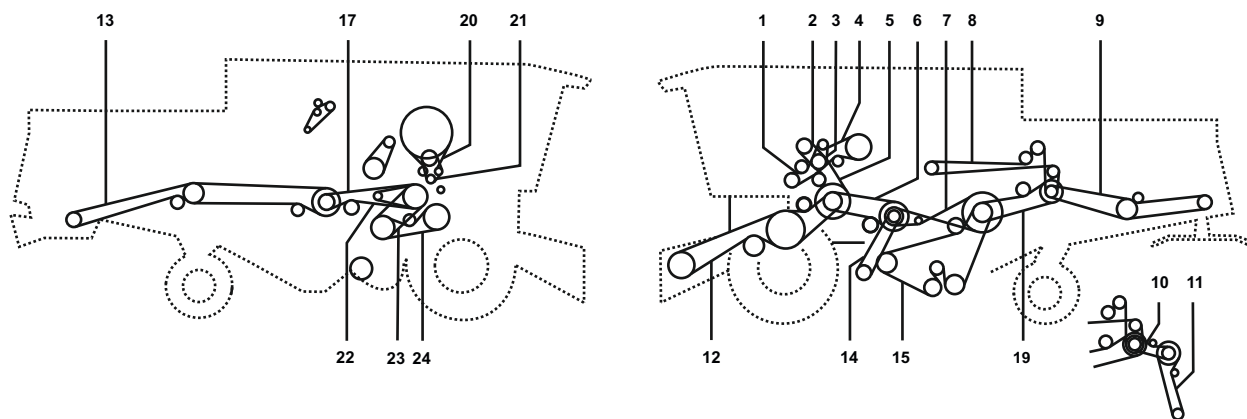

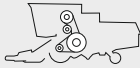
CLAAS MEGA 360 - 370



| Belt No. |  | No. of Belts | OEM  Part No. | PIX  Part No. |
|----------|---|--------------|--|--|
| 1 | - | 2 | 544049.1 | A-544049.1 |
| 2 | - | 1 | 656028.0 | A-656028.0 |
| 2 | - | 1 | 629002.1 | A-629002.1 |
| 3 | - | 1 | 621903.1 | A-621903.1 |
| 4 | - | 1 | 544166.0 | A-544166.0 |
| 5 | - | 1 | 544164.0 | A-544164.0 |
| 6 | - | 1 | 603337.0 | A-603337.0 |
| 6 | - | 1 | 667238.0 | A-667238.0 |
| 7 | - | 1 | 644141.1 | A-644141.1 |
| 8 | - | 1 | 644447.0 | A-644447.0 |
| 9 | - | 1 | 623427.1 | A-623427.1 |
| 10 | - | 1 | 755070.1 | A-755070.1 |
| 11 | - | 1 | 066034.0 | A-066034.0 |
| 11 | - | 1 | 785341.0 | A-785341.0 |
| 12 | - | 2 | 644368.0 | A-644368.0 |
| 13 | - | 1 | 544172.0 | A-544172.0 |
| 14 | - | 1 | 603380.1 | A-603380.1 |
| 15 | - | 1 | 609762.0 | A-609762.0 |
| 17 | - | 1 | 644538.0 | A-644538.0 |
| 19 | - | 1 | 506671.2 | A-506671.2 |
| 20 | From Nr. 84500262 | 1 | 821734.2 | A-821734.2 |
| 20 | To Nr. 84500261 | 1 | 545689.0 | A-545689.0 |
| 21 | To Nr. 84500261 | 1 | 545668.1 | A-545668.1 |
| 22 | - | 1 | 644537.0 | A-644537.0 |
| 23 | From Nr. 84500387 | 1 | 661427.0 | A-661427.0 |
| 23 | To Nr. 84500386 High - Low Speed | 1 | 609823.0 | A-609823.0 |
| 24 | Drum Drive Variable Speed (n=650-1500 Rpm) | 1 | 661220.1 | A-661220.1 |
| 0 | Alternator Drive (from Nr. 84500262) | 1 | 796998.0 | A-796998.0 |
| 0 | Alternator Drive (till Nr. 84500261) | 1 | 545954.0 | A-545954.0 |

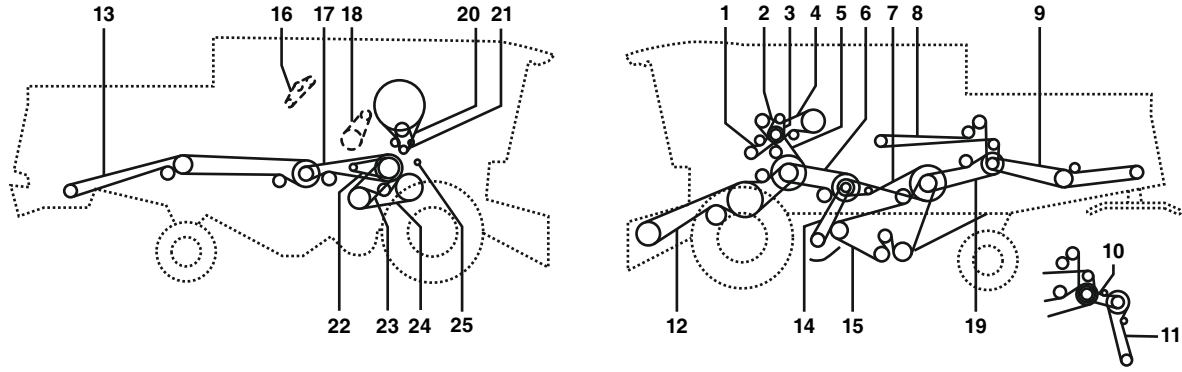

CLAAS MEGA 360 TYP 845



| Belt No. |  | No. of Belts | OEM  Part No. | PIX  Part No. |
|----------|---|--------------|--|--|
| 1 | 1 Set = 2 Belts | 2 | 544049.1 | A-544049.1 |
| 2 | - | 1 | 656028.0 | A-656028.0 |
| 2 | When Threshing | 1 | 629002.1 | A-629002.1 |
| 3 | - | 1 | 621903.1 | A-621903.1 |
| 4 | - | 1 | 544166.0 | A-544166.0 |
| 5 | - | 1 | 544164.0 | A-544164.0 |
| 6 | - | 1 | 603337.0 | A-603337.0 |
| 6 | When Threshing | 1 | 667238.0 | A-667238.0 |
| 7 | - | 1 | 644141.1 | A-644141.1 |
| 8 | - | 1 | 644447.0 | A-644447.0 |
| 9 | - | 1 | 623427.1 | A-623427.1 |
| 10 | - | 1 | 755070.1 | A-755070.1 |
| 11 | N = 519 | 1 | 066034.0 | A-066034.0 |
| 11 | N = 660 | 1 | 785341.0 | A-785341.0 |
| 12 | - | 2 | 644368.0 | A-644368.0 |
| 13 | - | 1 | 544172.0 | A-544172.0 |
| 14 | - | 1 | 603380.1 | A-603380.1 |
| 15 | - | 1 | 609762.0 | A-609762.0 |
| 17 | - | 1 | 644538.0 | A-644538.0 |
| 19 | - | 1 | 506671.2 | A-506671.2 |
| 20 | From No. 84500262 | 1 | 821734.2 | A-821734.2 |
| 20 | To No. 84500261 | 1 | 545689.0 | A-545689.0 |
| 21 | To No. 84500261 | 1 | 545668.1 | A-545668.1 |
| 22 | - | 1 | 644537.0 | A-644537.0 |
| 23 | From No. 84500387 | 1 | 661427.0 | A-661427.0 |
| 23 | To No.84500386 High-Low Speed Range Transmission | 1 | 609823.0 | A-609823.0 |
| 24 | Drum Variable Speed Drive N = 650 - 1500 | 1 | 661220.1 | A-661220.1 |
| 0 | Alternator From No. 84500262 | 1 | 796998.0 | A-796998.0 |
| 0 | Alternator From Nr. 84500261 | 1 | 545954.0 | A-545954.0 |

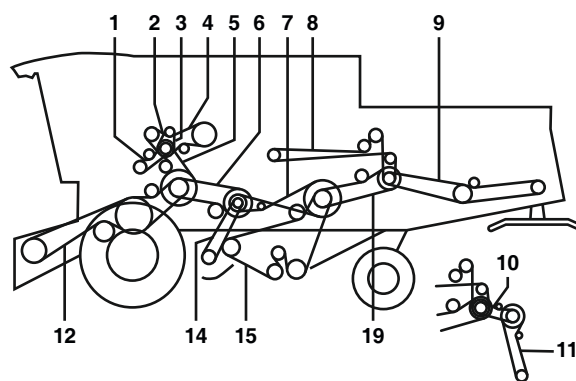
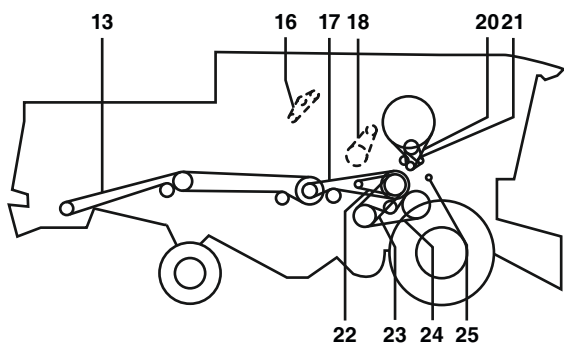

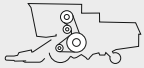
CLAAS MEGA 360 TYP 846

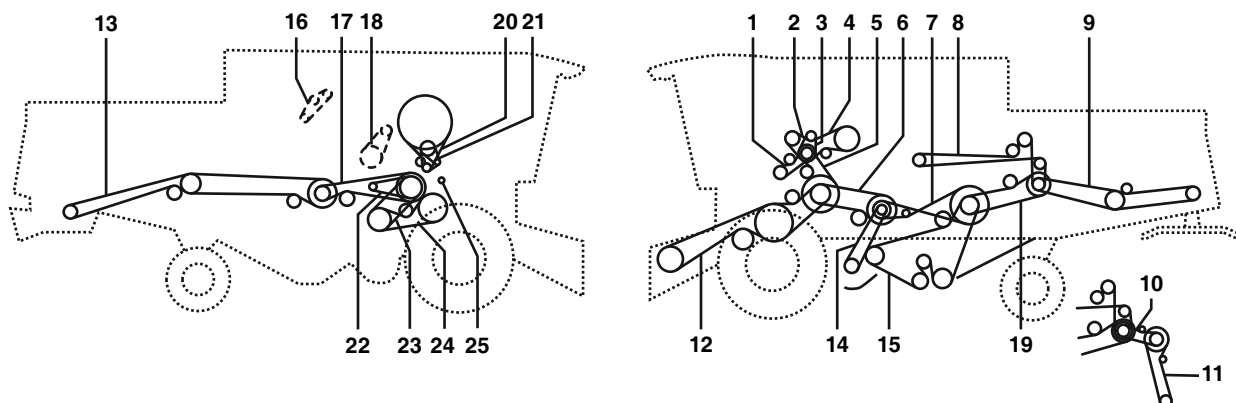

| Belt No. |  | No. of Belts | OEM  Part No. | PIX  Part No. |
|----------|---|--------------|--|--|
| 1 | 1 Set = 2 Belts | 2 | 544049.1 | A-544049.1 |
| 2 | - | 1 | 656028.0 | A-656028.0 |
| 2 | When Threshing | 1 | 629002.1 | A-629002.1 |
| 3 | - | 1 | 621903.1 | A-621903.1 |
| 4 | - | 1 | 544166.0 | A-544166.0 |
| 5 | - | 1 | 544164.0 | A-544164.0 |
| 6 | - | 1 | 603337.0 | A-603337.0 |
| 6 | When Threshing | 1 | 667238.0 | A-667238.0 |
| 7 | - | 1 | 644141.1 | A-644141.1 |
| 8 | - | 1 | 644447.0 | A-644447.0 |
| 9 | - | 1 | 623427.1 | A-623427.1 |
| 10 | - | 1 | 755070.1 | A-755070.1 |
| 11 | N = 519 | 1 | 066034.0 | A-066034.0 |
| 11 | - | 1 | 785341.0 | A-785341.0 |
| 12 | - | 2 | 644368.0 | A-644368.0 |
| 13 | - | 1 | 544172.0 | A-544172.0 |
| 14 | - | 1 | 603380.1 | A-603380.1 |
| 15 | - | 1 | 609762.0 | A-609762.0 |
| 17 | - | 1 | 644538.0 | A-644538.0 |
| 19 | - | 1 | 506671.2 | A-506671.2 |
| 20 | From No. 84500262 | 1 | 821734.2 | A-821734.2 |
| 20 | To No. 84500261 | 1 | 545689.0 | A-545689.0 |
| 21 | To No. 84500261 | 1 | 545668.1 | A-545668.1 |
| 22 | - | 1 | 644537.0 | A-644537.0 |
| 23 | From No. 84500387 | 1 | 661427.0 | A-661427.0 |
| 23 | To No. 84500386 High - Low Speed Range Trans | 1 | 609823.0 | A-609823.0 |
| 24 | Drum Variable Speed Drive N = 650 - 1500 | 1 | 661220.1 | A-661220.1 |
| 0 | Alternator From No. 84500262 | 1 | 796998.0 | A-796998.0 |
| 0 | Alternator From Nr. 84500261 | 1 | 545954.0 | A-545954.0 |

CLAAS MEGA 360 TYP C12



| Belt No. |  | No. of Belts | OEM  Part No. | PIX  Part No. |
|----------|---|--------------|--|--|
| 1 | 1 Set = 2 Belts | 2 | 544049.1 | A-544049.1 |
| 2 | - | 1 | 656028.0 | A-656028.0 |
| 2 | When Threshing | 1 | 629002.1 | A-629002.1 |
| 3 | - | 1 | 621903.1 | A-621903.1 |
| 4 | - | 1 | 544166.0 | A-544166.0 |
| 5 | - | 1 | 544164.0 | A-544164.0 |
| 6 | - | 1 | 603337.0 | A-603337.0 |
| 6 | When Threshing | 1 | 667238.0 | A-667238.0 |
| 7 | - | 1 | 644141.1 | A-644141.1 |
| 8 | - | 1 | 644447.0 | A-644447.0 |
| 9 | - | 1 | 623427.1 | A-623427.1 |
| 10 | - | 1 | 755070.1 | A-755070.1 |
| 11 | N = 519 | 1 | 066034.0 | A-066034.0 |
| 11 | N = 660 | 1 | 785341.0 | A-785341.0 |
| 12 | - | 2 | 644368.0 | A-644368.0 |
| 13 | - | 1 | 544172.0 | A-544172.0 |
| 14 | - | 1 | 603380.1 | A-603380.1 |
| 15 | - | 1 | 609762.0 | A-609762.0 |
| 17 | - | 1 | 644538.0 | A-644538.0 |
| 19 | - | 1 | 506671.2 | A-506671.2 |
| 20 | From No. 84500262 | 1 | 821734.2 | A-821734.2 |
| 20 | To No. 84500261 | 1 | 545689.0 | A-545689.0 |
| 21 | To No. 84500261 | 1 | 545668.1 | A-545668.1 |
| 22 | - | 1 | 644537.0 | A-644537.0 |
| 23 | From No. 84500387 | 1 | 661427.0 | A-661427.0 |
| 23 | To No. 84500386 High - Low Speed Range Transmission | 1 | 609823.0 | A-609823.0 |
| 24 | Drum Variable Speed Drive N = 650 - 1500 | 1 | 661220.1 | A-661220.1 |
| 0 | Alternator From No. 84500262 | 1 | 796998.0 | A-796998.0 |
| 0 | Alternator From Nr. 84500261 | 1 | 545954.0 | A-545954.0 |

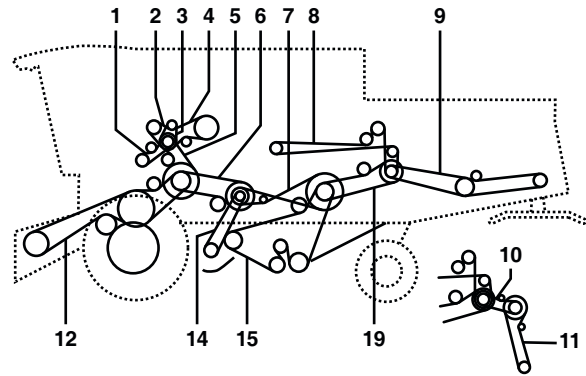
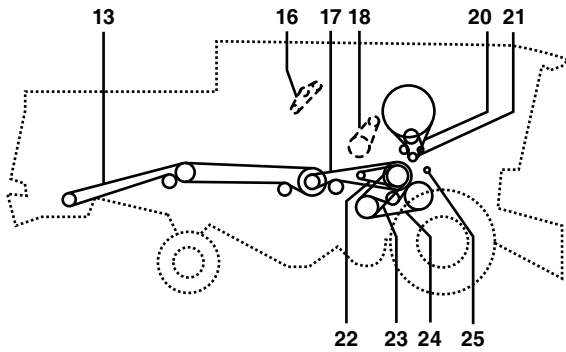

CLAAS MEGA 370 TYP 845



| Belt No. | | No. of Belts | OEM Part No. | PIX Part No. |
|----------|---|--------------|---------------|---------------|
| 1 | 1 Set = 2 Belts | 2 | 544049.1 | A-544049.1 |
| 2 | - | 1 | 656028.0 | A-656028.0 |
| 2 | When Threshing | 1 | 629002.1 | A-629002.1 |
| 3 | - | 1 | 621903.1 | A-621903.1 |
| 4 | - | 1 | 544166.0 | A-544166.0 |
| 5 | - | 1 | 544164.0 | A-544164.0 |
| 6 | - | 1 | 603337.0 | A-603337.0 |
| 6 | When Threshing | 1 | 667238.0 | A-667238.0 |
| 7 | - | 1 | 644141.1 | A-644141.1 |
| 8 | - | 1 | 644447.0 | A-644447.0 |
| 9 | - | 1 | 623427.1 | A-623427.1 |
| 10 | - | 1 | 755070.1 | A-755070.1 |
| 11 | N = 519 | 1 | 066034.0 | A-066034.0 |
| 11 | N = 660 | 1 | 785341.0 | A-785341.0 |
| 12 | - | 2 | 644368.0 | A-644368.0 |
| 13 | - | 1 | 544172.0 | A-544172.0 |
| 14 | - | 1 | 603380.1 | A-603380.1 |
| 15 | - | 1 | 609762.0 | A-609762.0 |
| 17 | - | 1 | 644538.0 | A-644538.0 |
| 19 | - | 1 | 506671.2 | A-506671.2 |
| 20 | From No. 84500262 | 1 | 821734.2 | A-821734.2 |
| 20 | To No. 84500261 | 1 | 545689.0 | A-545689.0 |
| 21 | To No. 84500261 | 1 | 545668.1 | A-545668.1 |
| 22 | - | 1 | 644537.0 | A-644537.0 |
| 23 | From No. 84500387 | 1 | 661427.0 | A-661427.0 |
| 23 | To No. 84500386 High - Low Speed Range Trans. | 1 | 609823.0 | A-609823.0 |
| 24 | Drum Variable Speed Drive N= 650 - 1500 | 1 | 661220.1 | A-661220.1 |
| 0 | Alternator From No. 84500262 | 1 | 796998.0 | A-796998.0 |
| 0 | Alternator From Nr. 84500261 | 1 | 545954.0 | A-545954.0 |

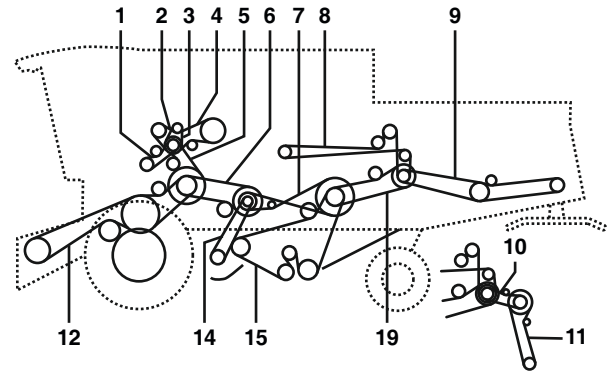
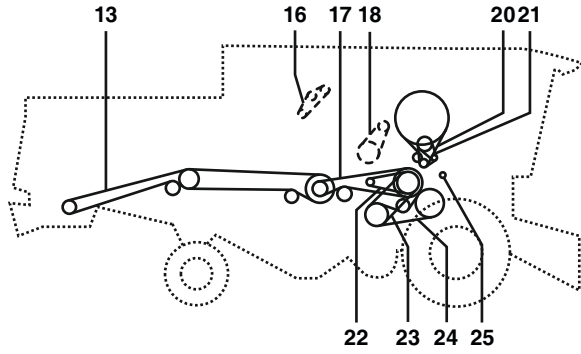

CLAAS MEGA 370 TYP 846



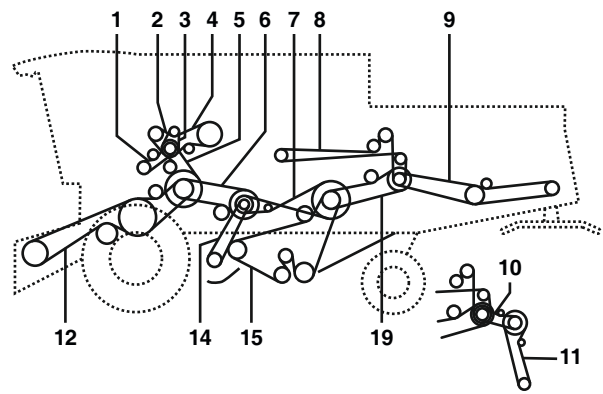
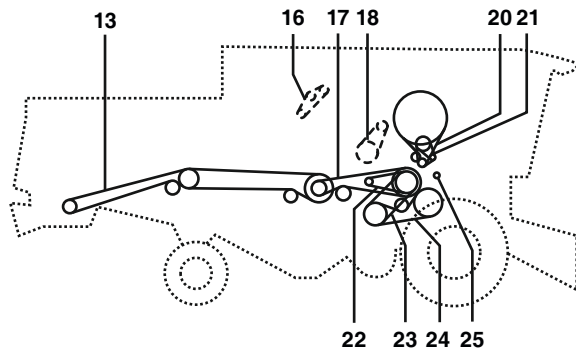

| Belt No. |  | No. of Belts | OEM  Part No. | PIX  Part No. |
|----------|---|--------------|--|--|
| 1 | 1 Set = 2 Belts | 2 | 544049.1 | A-544049.1 |
| 2 | - | 1 | 656028.0 | A-656028.0 |
| 2 | When Threshing | 1 | 629002.1 | A-629002.1 |
| 3 | - | 1 | 621903.1 | A-621903.1 |
| 4 | - | 1 | 544166.0 | A-544166.0 |
| 5 | - | 1 | 544164.0 | A-544164.0 |
| 6 | - | 1 | 603337.0 | A-603337.0 |
| 6 | When Threshing | 1 | 667238.0 | A-667238.0 |
| 7 | - | 1 | 644141.1 | A-644141.1 |
| 8 | - | 1 | 644447.0 | A-644447.0 |
| 9 | - | 1 | 623427.1 | A-623427.1 |
| 10 | - | 1 | 755070.1 | A-755070.1 |
| 11 | N = 519 | 1 | 066034.0 | A-066034.0 |
| 11 | - | 1 | 785341.0 | A-785341.0 |
| 12 | - | 2 | 644368.0 | A-644368.0 |
| 13 | - | 1 | 544172.0 | A-544172.0 |
| 14 | - | 1 | 603380.1 | A-603380.1 |
| 15 | - | 1 | 609762.0 | A-609762.0 |
| 17 | - | 1 | 644538.0 | A-644538.0 |
| 19 | - | 1 | 506671.2 | A-506671.2 |
| 20 | From No. 84500262 | 1 | 821734.2 | A-821734.2 |
| 20 | To No. 84500261 | 1 | 545689.0 | A-545689.0 |
| 21 | To No. 84500261 | 1 | 545668.1 | A-545668.1 |
| 22 | - | 1 | 644537.0 | A-644537.0 |
| 23 | From No. 84500387 | 1 | 661427.0 | A-661427.0 |
| 23 | To No. 84500386 High - Low Speed Range Transmission | 1 | 609823.0 | A-609823.0 |
| 24 | Drum Variable Speed Drive N = 650 - 1500 | 1 | 661220.1 | A-661220.1 |
| 0 | Alternator From No. 84500262 | 1 | 796998.0 | A-796998.0 |
| 0 | Alternator From Nr. 84500261 | 1 | 545954.0 | A-545954.0 |

CLAAS MEGA 370 TYP C12





| Belt No. |  | No. of Belts | OEM  Part No. | PIX  Part No. |
|----------|---|--------------|--|--|
| 1 | 1 Set = 2 Belts | 2 | 544049.1 | A-544049.1 |
| 2 | - | 1 | 656028.0 | A-656028.0 |
| 2 | When Threshing | 1 | 629002.1 | A-629002.1 |
| 3 | - | 1 | 621903.1 | A-621903.1 |
| 4 | - | 1 | 544166.0 | A-544166.0 |
| 5 | - | 1 | 544164.0 | A-544164.0 |
| 6 | - | 1 | 603337.0 | A-603337.0 |
| 6 | When Threshing | 1 | 667238.0 | A-667238.0 |
| 7 | - | 1 | 644141.1 | A-644141.1 |
| 8 | - | 1 | 644447.0 | A-644447.0 |
| 9 | - | 1 | 623427.1 | A-623427.1 |
| 10 | - | 1 | 755070.1 | A-755070.1 |
| 11 | N = 519 | 1 | 066034.0 | A-066034.0 |
| 11 | N = 660 | 1 | 785341.0 | A-785341.0 |
| 12 | - | 2 | 644368.0 | A-644368.0 |
| 13 | - | 1 | 544172.0 | A-544172.0 |
| 14 | - | 1 | 603380.1 | A-603380.1 |
| 15 | - | 1 | 609762.0 | A-609762.0 |
| 17 | - | 1 | 644538.0 | A-644538.0 |
| 19 | - | 1 | 506671.2 | A-506671.2 |
| 20 | From No. 84500262 | 1 | 821734.2 | A-821734.2 |
| 20 | To No. 84500261 | 1 | 545689.0 | A-545689.0 |
| 21 | To No. 84500261 | 1 | 545668.1 | A-545668.1 |
| 22 | - | 1 | 644537.0 | A-644537.0 |
| 23 | From No. 84500387 | 1 | 661427.0 | A-661427.0 |
| 23 | To No. 84500386 High - Low Speed Range Trans. | 1 | 609823.0 | A-609823.0 |
| 24 | Drum Variable Speed Drive N = 650 - 1500 | 1 | 661220.1 | A-661220.1 |
| 0 | Alternator From No. 84500262 | 1 | 796998.0 | A-796998.0 |
| 0 | Alternator Till Nr. 84500261 | 1 | 545954.0 | A-545954.0 |

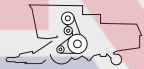

CLAAS MERCATOR

| Belt No. |  | No. of Belts | OEM  Part No. | PIX  Part No. |
|----------|---|--------------|--|--|
| 1 | Knife Drive | 1 | 610833.0 | A-610833 |
| 1 | Knife Drive | 2 | 610830.0 | A-610830 |
| 2 | Cylinder Variator Drive | 2 | 617309.0 | A-617309 |
| 3 | Main Drive | 1 | 630144.0 | A-630144 |
| 3 | Main Drive | 1 | 653059.0 | A-653059 |
| 3 | Main Drive | 1 | 653062.0 | A-653062 |
| 3 | Main Drive | 1 | 653064.0 | A-653064 |
| 4 | Main Drive | 1 | 653060.0 | A-653060 |
| 5 | Cutting Table Drive | 1 | 653063.0 | A-653063 |
| 6 | Shaker Shoe Drive | 1 | 653120.0 | A-653120 |
| 7 | Fanning Mill | 1 | 653121.0 | A-653121 |
| 8 | Straw Spreader Drive | 1 | 653450.0 | A-653450 |
| 9 | Hydraulic Pump Drive | 1 | 656028.0 | A-656028 |
| 10 | Reel Drive Variable Speed | 1 | 778561.0 | A-778561 |
| 11 | Straw Walker Drive | 1 | 653933.0 | A-653933 |
| 12 | Unloading Grain Tank | 1 | 654534.0 | A-654534 |
| 13 | Traction Drive | 1 | 655408.0 | A-655408 |
| 14 | Throw Off Drive | 1 | 750294.0 | A-750294 |

CLAAS MERCATOR 50 - 60

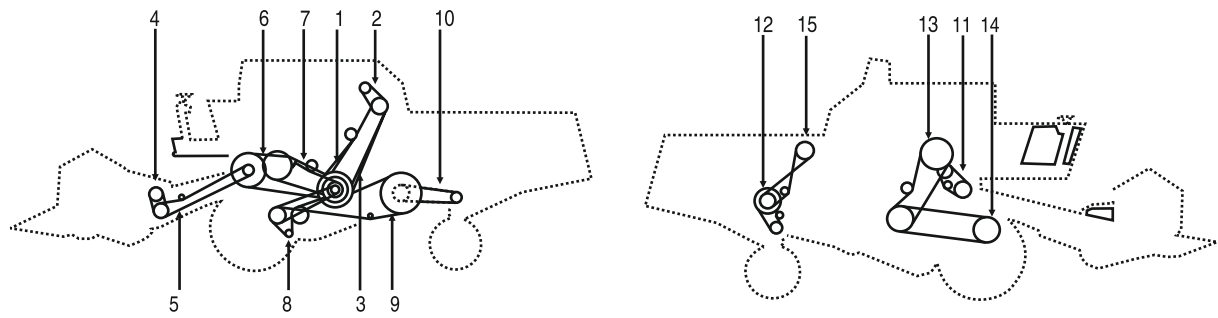

| Belt No. |  | No. of Belts | OEM  Part No. | PIX  Part No. |
|----------|---|--------------|--|--|
| 1 | Main Drive | 1 | 653060.0 | A-653060 |
| 2 | Hydraulic Pump Drive | 1 | 656028.0 | A-656028 |
| 3 | Main Drive | 1 | 630144.0 | A-630144 |
| 3 | Main Drive | 1 | 653059.0 | A-653059 |
| 3 | Main Drive | 1 | 653062.0 | A-653062 |
| 3 | Main Drive | 1 | 653064.0 | A-653064 |
| 4 | Reel Drive Variable Speed | 1 | 778561.0 | A-778561 |
| 5 | Knife Drive | 1 | 610833.0 | A-610833 |
| 5 | Knife Drive | 2 | 610830.0 | A-610830 |
| 6 | Cutting Table Drive | 1 | 653063.0 | A-653063 |
| 7 | Cylinder Variator Drive | 2 | 617309.0 | A-617309 |
| 8 | Fanning Mill | 1 | 653121.0 | A-653121 |
| 9 | Shaker Shoe Drive | 1 | 653120.0 | A-653120 |
| 10 | Drive Grain Tank | 1 | 634019.0 | A-634019 |
| 10 | Drive Grain Tank | 1 | 653450.0 | A-653450 |
| 11 | Straw Walker Drive | 1 | 755070.0 | A-755070 |
| 11 | Straw Walker Drive | 1 | 653933.0 | A-653933 |
| 12 | Turning Drum Drive | 1 | 750294.0 | A-750294 |
| 13 | Tank Unloader Drive | 1 | 653779.0 | A-653779 |
| 14 | Traction Drive | 1 | 655408.0 | A-655408 |



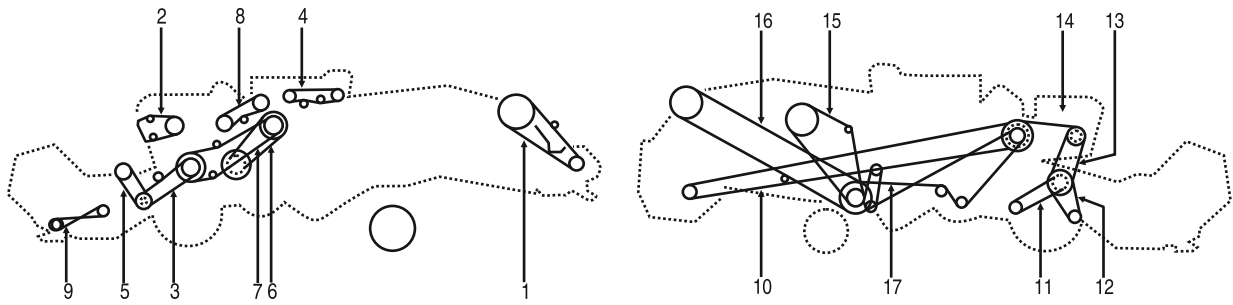

| Belt No. |  | No. of Belts | OEM  Part No. | PIX  Part No. |
|----------|---|--------------|--|--|
| 1 | Main Drive | 1 | 653060.0 | A-653060.0 |
| 2 | Hydraulic Pump Drive | 1 | 656028.0 | A-656028.0 |
| 3 | Main Drive | 1 | 630144.0 | A-630144.0 |
| 3 | Main Drive | 1 | 653059.0 | A-653059.0 |
| 3 | Main Drive | 1 | 653062.0 | A-653062.0 |
| 3 | Main Drive | 1 | 653064.0 | A-653064.0 |
| 4 | Reel Drive Variable Speed | 1 | 778561.0 | A-778561.0 |
| 5 | Knife Drive | 1 | 610833.0 | A-610833.0 |
| 5 | Knife Drive | 2 | 610830.0 | A-610830.0 |
| 6 | Cutting Table Drive | 1 | 653063.0 | A-653063.0 |
| 7 | Cylinder Variator drive | 2 | 617309.0 | A-617309.0 |
| 8 | Fanning Mill | 1 | 653380.0 | A-653380.0 |
| 9 | Shaker Shoe Drive | 1 | 653120.0 | A-653120.0 |
| 10 | Drive Grain Tank | 1 | 634019.0 | A-634019.0 |
| 10 | Drive Grain Tank | 1 | 653450.0 | A-653450.0 |
| 11 | Turning Drum Drive | 1 | 750294.0 | A-750294.0 |
| 12 | Straw Walker Drive | 1 | 755070.0 | A-755070.0 |
| 12 | Straw Walker Drive | 1 | 653933.0 | A-653933.0 |
| 13 | Tank Unloader Drive | 1 | 654534.0 | A-654534.0 |
| 14 | Traction Drive | 1 | 655408.0 | A-655408.0 |
| 15 | Shaker Shaft Drive | 1 | 687046.0 | A-687046.0 |

CLAAS MERCUR



| Belt No. |  | No. of Belts | OEM  Part No. | PIX  Part No. |
|----------|---|--------------|--|--|
| 1 | Baler | 1 | 500863.0 | A-500863.0 |
| 2 | Radiator Fan Drive | 1 | 758719.0 | A-758719.0 |
| 2 | Radiator Fan Drive | 1 | 758662.0 | A-758662.0 |
| 3 | Knife Drive | 1 | 770214.0 | A-770214.0 |
| 3 | Knife Drive | 1 | 778717.0 | A-778717.0 |
| 4 | Spreader Grain In Tank | 1 | 775698.0 | A-775698.0 |
| 5 | Reel Drive Variable Speed | 1 | 778561.0 | A-778561.0 |
| 6 | Cylinder | 1 | 779039.0 | A-779039.0 |
| 7 | Cutting Table Drive | 1 | 779272.0 | A-779272.0 |
| 7 | Cutting Table Drive | 1 | 779214.0 | A-779214.0 |
| 8 | Tank Unloader Drive | 1 | 780419.0 | A-780419.0 |
| 9 | Pick Up Drive | 1 | 800309.0 | A-800309.0 |
| 10 | Straw Chopper Drive | 1 | 551190.0 | A-551190.0 |
| 11 | Traction Variator Drive | 1 | 751112.0 | A-751112.0 |
| 13 | Traction Drive | 1 | 758853.0 | A-758853.0 |
| 14 | Threshing Machine | 1 | 758854.0 | A-758854.0 |
| 16 | Shaker Shoe Fan Elevator - Baler | 1 | 779212.0 | A-779212.0 |
| 17 | Shaker Shoe Fan Elevator | 1 | 779213.0 | A-779213.0 |



CLAAS OLDER MODELS

| Belt No. |  | No. of Belts | OEM  Part No. | PIX  Part No. |
|----------|---|--------------|--|--|
| 1 | FAN DRIVE | 1 | 505143.0 | A-505143 |
| 2 | BALER | 1 | 506023.0 | A-506023 |
| 3 | GOVERNOR DRIVE | 1 | 624131.0 | A-624131 |
| 4 | HYDRAULIC PUMP DRIVE | 1 | 633030.0 | A-633030 |
| 5 | SIEVE BOX | 1 | 634019.0 | A-634019 |
| 6 | STRAW WALKER DRIVE | 1 | 501925.0 | A-501925 |
| 7 | MAIN DRIVE FLAT BELT | 1 | 630025.0 | A-630025 |
| 8 | CYLINDER | 1 | 503969.0 | A-503969 |
| 9 | PICK UP DRIVE | 1 | 507020.0 | A-507020 |



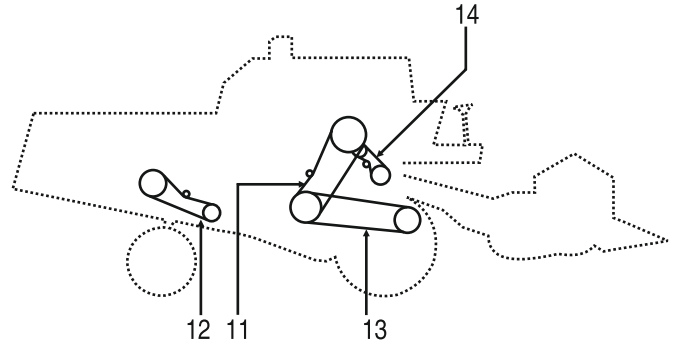
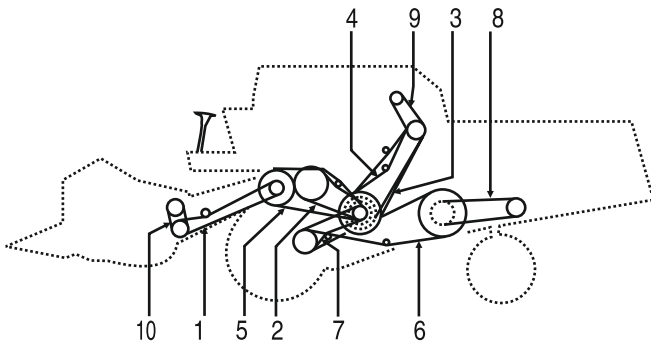

CLAAS PROTECTOR



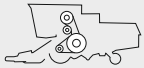

| Belt No. |  | No. of Belts | OEM  Part No. | PIX  Part No. |
|----------|---|--------------|--|--|
| 1 | Knife Drive | 1 | 610833.0 | A-610833.0 |
| 1 | Knife Drive | 2 | 610830.0 | A-610830.0 |
| 2 | Cylinder Variator Drive | 2 | 617309.0 | A-617309.0 |
| 3 | Main Drive | 1 | 630144.0 | A-630144.0 |
| 3 | Main Drive | 1 | 653059.0 | A-653059.0 |
| 3 | Main Drive | 1 | 653062.0 | A-653062.0 |
| 3 | Main Drive | 1 | 653064.0 | A-653064.0 |
| 4 | Cylinder Drive | 1 | 653060.0 | A-653060.0 |
| 5 | Cutting Table Drive | 1 | 653063.0 | A-653063.0 |
| 6 | Shaker Shoe Drive | 1 | 653120.0 | A-653120.0 |
| 7 | Fanning Mill | 1 | 653121.0 | A-653121.0 |
| 8 | Shaker Shoe Drive | 1 | 653450.0 | A-653450.0 |
| 9 | Hydraulic Pump Drive | 1 | 656028.0 | A-656028.0 |
| 10 | Reel Drive Variable Speed | 1 | 778561.0 | A-778561.0 |
| 11 | Tank Unloader Drive | 1 | 653779.0 | A-653779.0 |
| 12 | Straw Walker Drive | 1 | 653933.0 | A-653933.0 |
| 13 | Traction Drive | 1 | 655408.0 | A-655408.0 |
| 14 | Turning Drum Drive | 1 | 750294.0 | A-750294.0 |

CLAAS SENATOR



| Belt No. |  | No. of Belts | OEM  Part No. | PIX  Part No. |
|----------|---|--------------|--|--|
| 1 | Knife Drive | 1 | 610833.0 | A-610833 |
| 1 | Knife Drive | 2 | 610830.0 | A-610830 |
| 2 | Cylinder Variator Drive | 2 | 617309.0 | A-617309 |
| 3 | Main Drive | 1 | 630144.0 | A-630144 |
| 3 | Main Drive | 1 | 653059.0 | A-653059 |
| 3 | Main Drive | 1 | 653062.0 | A-653062 |
| 3 | Main Drive | 1 | 653064.0 | A-653064 |
| 4 | Hydraulic Pump Drive | 1 | 633030.0 | A-633030 |
| 5 | Cylinder | 1 | 653060.0 | A-653060 |
| 6 | Cutting Table Drive | 1 | 653063.0 | A-653063 |
| 7 | Shaker Shoe Drive | 1 | 653120.0 | A-653120 |
| 8 | Fanning Mill | 1 | 653380.0 | A-653380 |
| 8 | Fanning Mill | 1 | 653121.0 | A-653121 |
| 9 | Reel Drive Variable Speed | 1 | 778561.0 | A-778561 |
| 10 | Traction Drive | 1 | 631904.0 | A-631904 |
| 10 | Traction Drive | 1 | 655408.0 | A-655408 |
| 11 | Tank Unloader Drive | 1 | 654013.0 | A-654013 |
| 12 | Turning Drum Drive | 1 | 750294.0 | A-750294 |
| 13 | Straw Walker Drive | 1 | 801222.0 | A-801222 |
| 13 | Straw Walker Drive | 1 | 653933.0 | A-653933 |

CLAAS SF

| Belt No. |  | No. of Belts | OEM  Part No. | PIX  Part No. |
|----------|---|--------------|--|--|
| 1 | DRIVE GRAIN TANK | 1 | 636021.0 | A-636021 |
| 2 | DRIVE GRAIN TANK | 1 | 636021.1 | A-636021.1 |
| 3 | ENGINE | 1 | 624131.0 | A-624131 |
| 4 | HYDRAULIC PUMP DRIVE | 1 | 633030.0 | A-633030 |
| 5 | STRAW SHAKER | 1 | 618123.0 | A-618123 |
| 6 | CUTTING TABLE DRIVE | 1 | 610197.0 | A-610197 |
| 7 | MAIN DRIVE | 2 | 617309.0 | A-617309 |
| 8 | MAIN DRIVE | 1 | 630144.0 | A-630144 |
| 9 | TRACTION DRIVE | 1 | 630156.0 | A-630156 |
| 10 | MAIN DRIVE FLAT BELT | 1 | 630043.0 | A-630043 |
| 11 | MAIN DRIVE FLAT BELT | 1 | 630025.0 | A-630025 |
| 12 | MAIN DRIVE | 1 | 630118.0 | A-630118 |

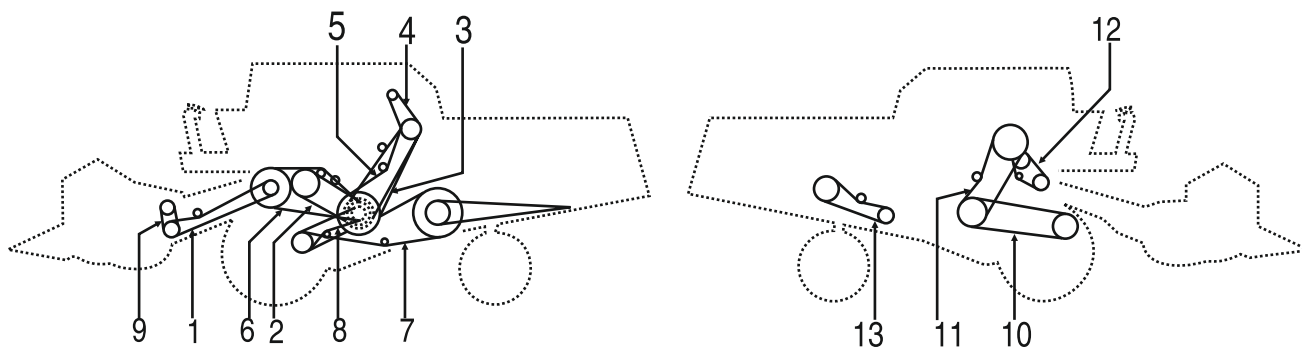

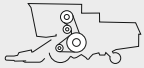
CLAAS SENATOR 80 - 85



| Belt No. |  | No. of Belts | OEM  Part No. | PIX  Part No. |
|----------|---|--------------|--|--|
| 1 | Knife Drive | 1 | 610833.0 | A-610833.0 |
| 1 | Knife Drive | 2 | 610830.0 | A-610830.0 |
| 2 | Cylinder Variator drive | 2 | 617309.0 | A-617309.0 |
| 3 | Main Drive | 1 | 630144.0 | A-630144.0 |
| 3 | Main Drive | 1 | 653059.0 | A-653059.0 |
| 3 | Main Drive | 1 | 653062.0 | A-653062.0 |
| 3 | Main Drive | 1 | 653064.0 | A-653064.0 |
| 4 | Hydraulic Pump Drive | 1 | 633030.0 | A-633030.0 |
| 5 | Cylinder | 1 | 653060.0 | A-653060.0 |
| 6 | Cutting Table Drive | 1 | 653063.0 | A-653063.0 |
| 7 | Shaker Shoe Drive | 1 | 653120.0 | A-653120.0 |
| 8 | Fanning Mill | 1 | 653380.0 | A-653380.0 |
| 8 | Fanning Mill | 1 | 653121.0 | A-653121.0 |
| 9 | Reel Drive Variable Speed | 1 | 778561.0 | A-778561.0 |
| 10 | Traction Drive | 1 | 631904.0 | A-631904.0 |
| 10 | Traction Drive | 1 | 655408.0 | A-655408.0 |
| 11 | Tank Unloader Drive | 1 | 654013.0 | A-654013.0 |
| 12 | Turning Drum Drive | 1 | 750294.0 | A-750294.0 |
| 13 | Straw Walker Drive | 1 | 801222.0 | A-801222.0 |
| 13 | Straw Walker Drive | 1 | 653933.0 | A-653933.0 |

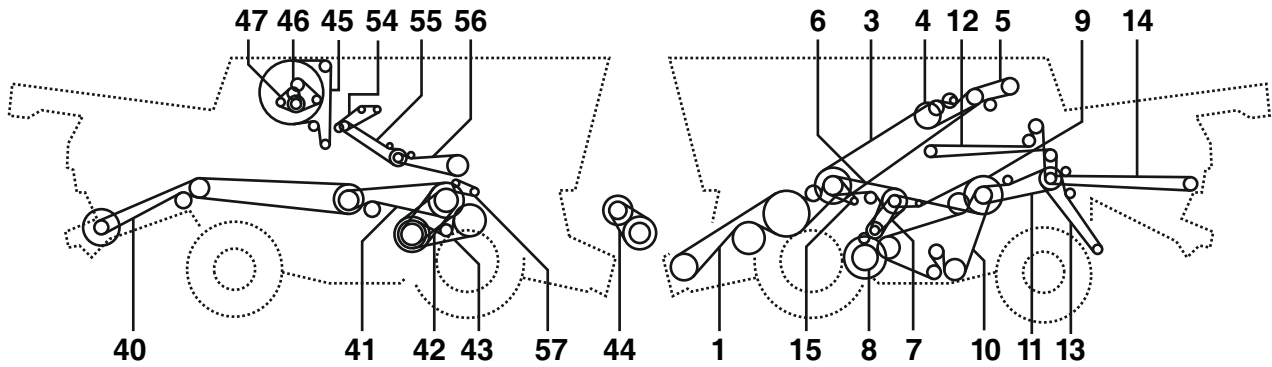

CLAAS TUCANO 330 - 320



| Belt No. |  | No. of Belts | OEM  Part No. | PIX  Part No. |
|----------|---|--------------|--|--|
| 1 | - | 2 | 554017.0 | A-554017.0 |
| 3 | - | 1 | 549099.0 | A-549099.0 |
| 4 | - | 1 | 667251.1 | A-667251.1 |
| 5 | - | 2 | 603247.1 | A-603247.1 |
| 6 | - | 1 | 603337.0 | A-603337.0 |
| 7 | - | 1 | 644362.0 | A-644362.0 |
| 8 | - | 1 | 644267.0 | A-644267.0 |
| 9 | - | 1 | 644141.1 | A-644141.1 |
| 10 | - | 1 | 609762.0 | A-609762.0 |
| 11 | - | 1 | 506671.2 | A-506671.2 |
| 12 | - | 1 | 644447.0 | A-644447.0 |
| 13 | - | 1 | 544216.0 | A-544216.0 |
| 14 | - | 1 | 629402.0 | A-629402.0 |
| 15 | - | 1 | 633030.2 | A-633030.2 |
| 40 | - | 1 | 544172.0 | A-544172.0 |
| 41 | - | 1 | 061700.1 | A-061700.1 |
| 42 | - | 1 | 661427.0 | A-661427.0 |
| 43 | - | 1 | 661220.1 | A-661220.1 |
| 44 | - | 1 | 661429.0 | A-661429.0 |
| 45 | - | 1 | 077276.0 | A-077276.0 |
| 46 | - | 1 | 799181.0 | A-799181.0 |
| 47 | - | 2 | 549752.0 | A-549752.0 |

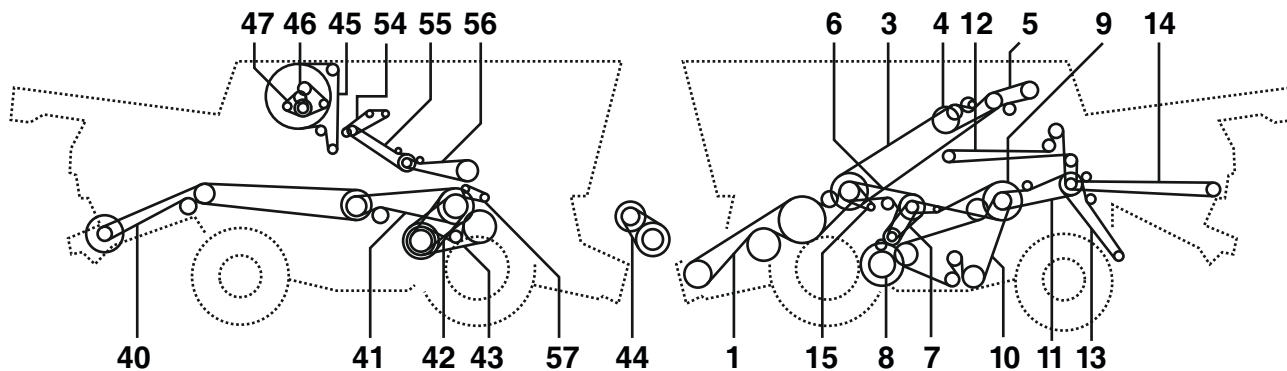

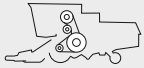
CLAAS TUCANO 340



| Belt No. |  | No. of Belts | OEM  Part No. | PIX  Part No. |
|----------|---|--------------|--|--|
| 1 | - | 2 | 554017.0 | A-554017.0 |
| 3 | - | 1 | 549099.0 | A-549099.0 |
| 4 | - | 1 | 667251.1 | A-667251.1 |
| 5 | - | 2 | 544049.1 | A-544049.1 |
| 6 | - | 1 | 603337.0 | A-603337.0 |
| 7 | - | 1 | 644362.0 | A-644362.0 |
| 8 | - | 1 | 538714.0 | A-538714.0 |
| 9 | - | 1 | 644141.1 | A-644141.1 |
| 10 | - | 1 | 609762.0 | A-609762.0 |
| 11 | - | 1 | 506671.2 | A-506671.2 |
| 12 | - | 1 | 644447.0 | A-644447.0 |
| 13 | - | 1 | 544216.0 | A-544216.0 |
| 14 | - | 1 | 629402.0 | A-629402.0 |
| 15 | - | 1 | 633030.2 | A-633030.2 |
| 40 | - | 1 | 544172.0 | A-544172.0 |
| 41 | - | 1 | 061700.1 | A-061700.1 |
| 42 | - | 1 | 661427.0 | A-661427.0 |
| 43 | - | 1 | 661220.1 | A-661220.1 |
| 44 | - | 1 | 661429.0 | A-661429.0 |
| 45 | - | 1 | 077276.0 | A-077276.0 |
| 46 | - | 1 | 799181.0 | A-799181.0 |
| 47 | - | 2 | 549752.0 | A-549752.0 |

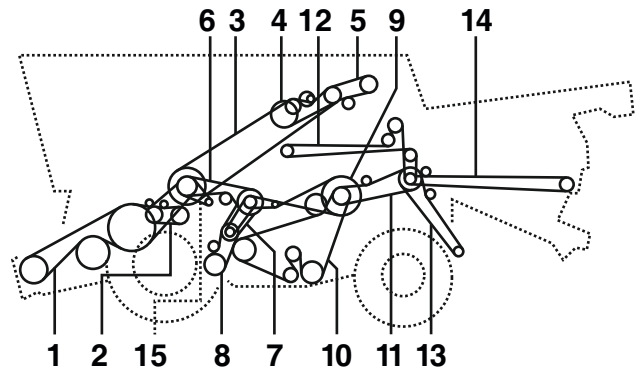
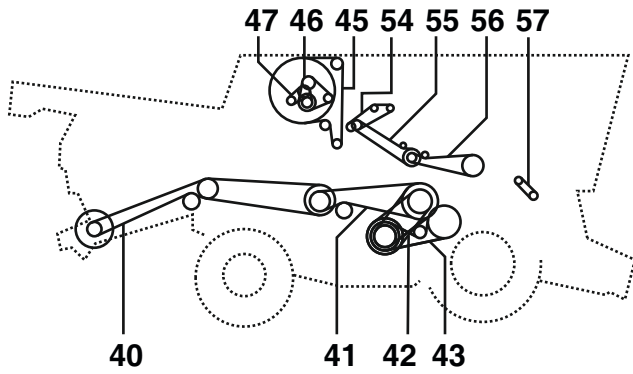

CLAAS TUCANO 430



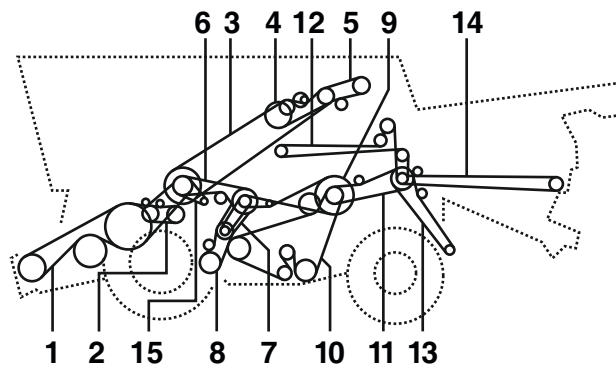
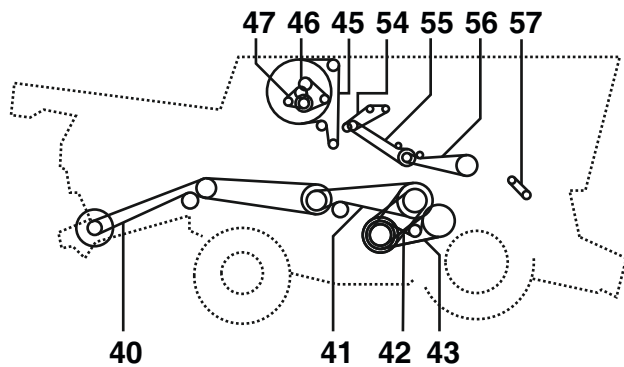

| Belt No. | | No. of Belts | OEM  Part No. | PIX  Part No. |
|----------|---|--------------|--|--|
| 1 | - | 2 | 549055.0 | A-549055.0 |
| 2 | - | 1 | 661031.1 | A-661031.1 |
| 3 | - | 1 | 549099.0 | A-549099.0 |
| 4 | - | 1 | 667251.1 | A-667251.1 |
| 5 | - | 2 | 544049.1 | A-544049.1 |
| 6 | - | 1 | 603337.0 | A-603337.0 |
| 7 | - | 1 | 644362.0 | A-644362.0 |
| 8 | - | 1 | 538714.0 | A-538714.0 |
| 9 | - | 1 | 644141.1 | A-644141.1 |
| 10 | - | 1 | 609762.0 | A-609762.0 |
| 11 | - | 1 | 506671.2 | A-506671.2 |
| 12 | - | 1 | 644447.0 | A-644447.0 |
| 13 | - | 1 | 544216.0 | A-544216.0 |
| 14 | - | 1 | 629402.0 | A-629402.0 |
| 15 | - | 1 | 633030.2 | A-633030.2 |
| 40 | - | 1 | 544172.0 | A-544172.0 |
| 41 | - | 1 | 061700.1 | A-061700.1 |
| 42 | - | 1 | 661427.0 | A-661427.0 |
| 43 | - | 1 | 661220.1 | A-661220.1 |
| 45 | - | 1 | 077276.0 | A-077276.0 |
| 46 | - | 1 | 799181.0 | A-799181.0 |
| 47 | - | 2 | 549752.0 | A-549752.0 |

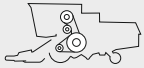
CLAAS TUCANO 450 - 440



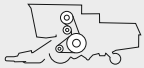

| Belt No. |  | No. of Belts | OEM  Part No. | PIX  Part No. |
|----------|---|--------------|--|--|
| 1 | - | 2 | 549055.0 | A-549055.0 |
| 2 | - | 1 | 661031.1 | A-661031.1 |
| 3 | - | 1 | 549099.0 | A-549099.0 |
| 4 | - | 1 | 667251.1 | A-667251.1 |
| 5 | - | 2 | 544049.1 | A-544049.1 |
| 6 | - | 1 | 603337.0 | A-603337.0 |
| 7 | - | 1 | 644362.0 | A-644362.0 |
| 8 | - | 1 | 538714.0 | A-538714.0 |
| 9 | - | 1 | 644141.1 | A-644141.1 |
| 10 | - | 1 | 609762.0 | A-609762.0 |
| 11 | - | 1 | 506671.2 | A-506671.2 |
| 12 | - | 1 | 644447.0 | A-644447.0 |
| 13 | - | 1 | 544216.0 | A-544216.0 |
| 14 | - | 1 | 629402.0 | A-629402.0 |
| 15 | - | 1 | 633030.2 | A-633030.2 |
| 40 | - | 1 | 544172.0 | A-544172.0 |
| 41 | - | 1 | 061700.1 | A-061700.1 |
| 42 | - | 1 | 661427.0 | A-661427.0 |
| 43 | - | 1 | 661220.1 | A-661220.1 |
| 45 | - | 1 | 077276.0 | A-077276.0 |
| 46 | - | 1 | 799181.0 | A-799181.0 |
| 47 | - | 2 | 549752.0 | A-549752.0 |

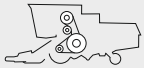

DEUTZ-FAHR 6095 HTS

| Belt No. |  | No. of Belts | OEM  Part No. | PIX  Part No. |
|----------|---|--------------|--|--|
| 1 | - | 1 | 1146033 | A-1146033 |
| 3 | - | 1 | 16062738 | A-16062738 |
| 4 | - | 1 | 1145331 | A-1145331 |
| 5 | - | 1 | 1145369 | A-1145369 |
| 6 | - | 1 | 1145374 | A-1145374 |
| 7 | - | 3 | 1145049 | A-1145049 |
| 8 | - | 1 | 16062735 | A-16062735 |
| 9 | - | 1 | 1145055 | A-1145055 |
| 12 | - | 1 | 16062737 | A-16062737 |
| 13 | - | 1 | 16062841 | A-16062841 |
| 14 | - | 1 | 1146013 | A-1146013 |
| 15 | - | 1 | 1116096 | A-1116096 |
| 16 | - | 1 | 16061769 | A-16061769 |
| 17 | - | 1 | 1145318 | A-1145318 |
| 19 | - | 1 | 1145025 | A-1145025 |
| 20 | - | 2 | 1145790 | A-1145790 |
| 21 | - | 3 | 1143413 | A-1143413 |
| 23 | - | 1 | 1145052 | A-1145052 |
| 24 | - | 2 | 1145989 | A-1145989 |
| 25 | - | 2 | 1143410 | A-1143410 |
| 26 | - | 1 | 1145329 | A-1145329 |
| 27 | - | 1 | 1145884 | A-1145884 |
| 28 | - | 1 | 1145504 | A-1145504 |

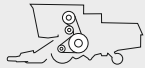

DEUTZ-FAHR M 88 - M 88 S

| Belt No. |  | No. of Belts | OEM  Part No. | PIX  Part No. |
|----------|---|--------------|--|--|
| 1 | - | 1 | 1100903 | A-1100903 |
| 3 | - | 1 | 6212870 | A-6212870 |
| 4 | - | 1 | 6215195 | A-6215195 |

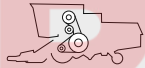

DEUTZ-FAHR M 600

| Belt No. |  | No. of Belts | OEM  Part No. | PIX  Part No. |
|----------|---|--------------|--|--|
| 1 | Straw Stripper Drum | 1 | 6234476 | A-6234476 |
| 3 | Traction Drive | 1 | 6236657 | A-6236657 |
| 4 | Straw Chopper Counter shaft | 1 | 6211034 | A-6211034 |
| 5 | Platform Channel | 1 | 6311053 | A-6311053 |
| 6 | Counter shaft - Pick Up | 1 | 1130742 | A-1130742 |
| 7 | Pick Up Drive | 1 | 6210915 | A-6210915 |
| 8 | Elevator Drive Grain | 1 | 6210922 | A-6210922 |
| 9 | Straw Baler | 1 | 1139090 | A-1139090 |
| 10 | Counter shaft - Baler | 1 | 1139089 | A-1139089 |
| 11 | Straw Chopper Drive | 1 | 1139085 | A-1139085 |
| 12 | - | 1 | 6212870 | A-6212870 |
| 13 | Reel Drive | 1 | 6215195 | A-6215195 |
| 14 | Return Elevator Drive | 1 | 1100903 | A-1100903 |
| 15 | Shaker Shoe Drive | 1 | 1116080 | A-1116080 |
| 15 | Radiator Fan Drive | 1 | 1139216 | A-1139216 |
| 15 | Alternator Drive | 1 | 1139217 | A-1139217 |



DEUTZ-FAHR M 660 - M 770

| Belt No. |  | No. of Belts | OEM  Part No. | PIX  Part No. |
|----------|---|--------------|--|--|
| 1 | Angular Gear - Straw Stripper Drum | 1 | 6234476 | A-6234476 |
| 3 | Angular Gear - Travel Drive | 1 | 6236657 | A-6236657 |
| 4 | Straw Stripper Drum - Return Auger | 1 | 6211034 | A-6211034 |
| 5 | Straw Stripper Drum - Conveyor Passage | 1 | 6211053 | A-6211053 |
| 6 | Angular Gear - Chopper Transmission | 1 | 6211001 | A-6211001 |
| 7 | Chopper Drive / M660 | 1 | 1139082 | A-1139082 |
| 7 | Chopper Drive / M770 | 1 | 6211004 | A-6211004 |
| 9 | Straw Walker - Grain Auger | 1 | 6210922 | A-6210922 |
| 10 | Return Auger - Chopper / M660 | 1 | 1139085 | A-1139085 |
| 10 | Return Auger - Chopper / M770 | 1 | 6211010 | A-6211010 |
| 15 | Countershaft - Reel Drive | 1 | 6212870 | A-6212870 |
| 16 | Reel Drive Countershaft | 1 | 6215195 | A-6215195 |
| 18 | Return Auger - Variator | 1 | 1100903 | A-1100903 |
| 19 | Fan Drive Variable Speed | 1 | 1116080 | A-1116080 |
| 21 | Blower Drive | 1 | 2235175 | A-2235175 |
| 22 | Alternator Drive | 1 | 2235178 | A-2235178 |

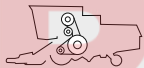

DEUTZ-FAHR M 600

| Belt No. |  | No. of Belts | OEM  Part No. | PIX  Part No. |
|----------|---|--------------|--|--|
| 1 | Straw Stripper Drum | 1 | 6234476 | A-6234476 |
| 3 | Traction Drive | 1 | 6236657 | A-6236657 |
| 4 | Straw Chopper Counter shaft | 1 | 6211034 | A-6211034 |
| 5 | Platform Channel | 1 | 6311053 | A-6311053 |
| 6 | Counter shaft - Pick Up | 1 | 1130742 | A-1130742 |
| 7 | Pick Up Drive | 1 | 6210915 | A-6210915 |
| 8 | Elevator Drive Grain | 1 | 6210922 | A-6210922 |
| 9 | Straw Baler | 1 | 1139090 | A-1139090 |
| 10 | Counter shaft - Baler | 1 | 1139089 | A-1139089 |
| 11 | Straw Chopper Drive | 1 | 1139085 | A-1139085 |
| 12 | - | 1 | 6212870 | A-6212870 |
| 13 | Reel Drive | 1 | 6215195 | A-6215195 |
| 14 | Return Elevator Drive | 1 | 1100903 | A-1100903 |
| 15 | Shaker Shoe Drive | 1 | 1116080 | A-1116080 |
| 15 | Radiator Fan Drive | 1 | 1139216 | A-1139216 |
| 15 | Alternator Drive | 1 | 1139217 | A-1139217 |



DEUTZ-FAHR M 660 - M 770

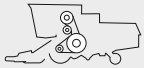

| Belt No. |  | No. of Belts | OEM  Part No. | PIX  Part No. |
|----------|---|--------------|--|--|
| 1 | Angular Gear - Straw Stripper Drum | 1 | 6234476 | A-6234476 |
| 3 | Angular Gear - Travel Drive | 1 | 6236657 | A-6236657 |
| 4 | Straw Stripper Drum - Return Auger | 1 | 6211034 | A-6211034 |
| 5 | Straw Stripper Drum - Conveyor Passage | 1 | 6211053 | A-6211053 |
| 6 | Angular Gear - Chopper Transmission | 1 | 6211001 | A-6211001 |
| 7 | Chopper Drive / M660 | 1 | 1139082 | A-1139082 |
| 7 | Chopper Drive / M770 | 1 | 6211004 | A-6211004 |
| 9 | Straw Walker - Grain Auger | 1 | 6210922 | A-6210922 |
| 10 | Return Auger - Chopper / M660 | 1 | 1139085 | A-1139085 |
| 10 | Return Auger - Chopper / M770 | 1 | 6211010 | A-6211010 |
| 15 | Countershaft - Reel Drive | 1 | 6212870 | A-6212870 |
| 16 | Reel Drive Countershaft | 1 | 6215195 | A-6215195 |
| 18 | Return Auger - Variator | 1 | 1100903 | A-1100903 |
| 19 | Fan Drive Variable Speed | 1 | 1116080 | A-1116080 |
| 21 | Blower Drive | 1 | 2235175 | A-2235175 |
| 22 | Alternator Drive | 1 | 2235178 | A-2235178 |

DEUTZ-FAHR M 750

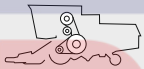

| Belt No. |  | No. of Belts | OEM  Part No. | PIX  Part No. |
|----------|---|--------------|--|--|
| 1 | Straw Stripper Drum | 1 | 6234476 | A-6234476 |
| 4 | Traction Drive | 1 | 6236657 | A-6236657 |
| 5 | Straw Chopper Drive | 1 | 6211034 | A-6211034 |
| 6 | Straw Stripper Drum | 1 | 6211053 | A-6211053 |
| 7 | Platform Channel | 1 | 1130742 | A-1130742 |
| 8 | Pick Up Drive | 1 | 6210915 | A-6210915 |
| 9 | Elevator Shaker Grain | 1 | 6210922 | A-6210922 |
| 10 | Chopper Drive | 1 | 6211010 | A-6211010 |
| 11 | Reel Drive Variable Speed | 1 | 6212870 | A-6212870 |
| 12 | Reel Drive | 1 | 6215195 | A-6215195 |
| 13 | Return Elevator Drive | 1 | 1100903 | A-1100903 |
| 14 | Shaker Shoe Drive | 1 | 1116080 | A-1116080 |
| 14 | Alternator Drive | 1 | 1139216 | A-1139216 |
| 14 | Radiator Fan Drive | 1 | 1139220 | A-1139220 |

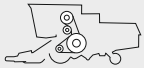
DEUTZ-FAHR M 900 - M 922 - M 1002



| Belt No. |  | No. of Belts | OEM  Part No. | PIX  Part No. |
|----------|--|--------------|---|---|
| 0 | Blower Drive (engine) / M1002 | 1 | 2235533 | A-2235533 |
| 0 | Blower Drive (engine) / M1080 | 1 | 2235254 | A-2235254 |
| 0 | Gen. Drive (engine) / -2280 M980/922 | 1 | 1168304 | A-1168304 |
| 0 | Blower Drive (engine) / M980 | 1 | 2235175 | A-2235175 |
| 0 | Generator Drive (engine) /+2281 M900-980 | 1 | 2235178 | A-2235178 |
| 0 | Generator Drive (engine) / -1980 M1002 | 1 | 2235179 | A-2235179 |
| 0 | Generator Drive (engine) /+1981 M1002/1080 | 1 | 2235180 | A-2235180 |
| 0 | Blower Drive (engine) / M900/922 | 1 | 2235531 | A-2235531 |
| 1 | Engine - Countershaft / M900/922/980/1080 | 1 | 6215236 | A-6215236 |
| 1 | Engine - Countershaft / M1002 | 1 | 6215237 | A-6215237 |
| 2 | Countershaft - Fan | 1 | 6215197 | A-6215197 |
| 3 | Threshing Drum | 1 | 6215220 | A-6215220 |
| 4 | Reel Variator | 1 | 6215217 | A-6215217 |
| 5 | Shaft Knife Drive | 1 | 6212919 | A-6212919 |
| 6 | Platform Feedchannel | 1 | 6210989 | A-6210989 |
| 7 | Countershaft - Travel Variator /+4233 M980/1080 | 1 | 6215215 | A-6215215 |
| 8 | Countershaft Grain Tank | 1 | 6212924 | A-6212924 |
| 9 | Tens Arm /m900+2660.m922+2706.m1002+2827 | 1 | 6210991 | A-6210991 |
| 9 | Tens Arm /m900-2659.m922-2530.m1002-2826 | 1 | 6212925 | A-6212925 |
| 10 | Returns Elevator | 1 | 6210991 | A-6210991 |
| 10 | Returns Elevator | 1 | 6212925 | A-6212925 |
| 11 | Countershaft - Straw Stripper Drum | 1 | 6215250 | A-6215250 |
| 12 | Grain Elevator | 1 | 6210921 | A-6210921 |
| 13 | Chopper Drive | 1 | 6211001 | A-6211001 |
| 14 | Chopper Drive | 1 | 6211006 | A-6211006 |

| Belt No. |  | No. of Belts | OEM  Part No. | PIX  Part No. |
|----------|---|--------------|--|--|
| 0 | Reel Drive Variable Speed | 1 | 6215217 | A-6215217 |
| 0 | Cutting Mechanical Countershaft - Knife Drive | 1 | 6210991 | A-6210991 |
| 3 | Gearbox Grain Tank | 1 | 6241147 | A-6241147 |
| 5 | Return Elevator Drive | 1 | 6240268 | A-6240268 |
| 6 | Straw Stripper Drum | 1 | 6211026 | A-6211026 |
| 7 | Platform Feed Channel | 1 | 6211026 | A-6211026 |
| 8 | Countershaft - Feed Channel | 1 | 6210915 | A-6210915 |
| 9 | Countershaft - Pick Up | 1 | 6210915 | A-6210915 |
| 10 | Hydraulic Steering | 1 | 1139231 | A-1139231 |
| 11 | Countershaft - Baler | 1 | 1139301 | A-1139301 |
| 12 | Baler | 1 | 6210997 | A-6210997 |
| 13 | Reel Drive Countershaft | 1 | 6215196 | A-6215196 |
| 14 | Countershaft - Fan Drive | 1 | 6240407 | A-6240407 |
| 15 | Countershaft - Fan Drive | 1 | 6215199 | A-6215199 |
| 16 | Alternator Drive | 1 | 1139218 | A-1139218 |
| 17 | Radiator Fan Drive | 1 | 1139221 | A-1139221 |
| 17 | Radiator Fan Drive | 1 | 1139222 | A-1139222 |
| 19 | Threshing Drum Variator drive | 1 | 6215222 | A-6215222 |

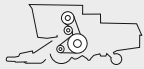

DEUTZ-FAHR M 1102 - M 1202

| Belt No. |  | No. of Belts | OEM  Part No. | PIX  Part No. |
|----------|---|--------------|--|--|
| 0 | Reel Drive Variable Speed | 1 | 6215217 | A-6215217 |
| 0 | Cutting Mechanical Countershaft - Knife Drive | 1 | 6210991 | A-6210991 |
| 1 | Engine - Straw Stripper Drum | 1 | 6528420 | A-6528420 |
| 3 | Drive Grain Tank | 1 | 6241147 | A-6241147 |
| 4 | Straw Stripper Drum - Countershaft | 1 | 6212933 | A-6212933 |
| 5 | Countershaft - Return Elevator | 1 | 6240268 | A-6240268 |
| 6 | Straw Stripper Drum - Countershaft | 1 | 6211026 | A-6211026 |
| 7 | Straw Stripper Drum - Feed Channel | 1 | 6211031 | A-6211031 |
| 8 | Chopper Drive | 1 | 1141798 | A-1141798 |
| 9 | Chopper Drive | 1 | 1136747 | A-1136747 |
| 10 | Engine - Compressor | 1 | 6212866 | A-6212866 |
| 11 | Fan Drive Variable Speed | 1 | 6215199 | A-6215199 |
| 12 | Threshing Drum Variator drive | 1 | 6215222 | A-6215222 |
| 13 | Blower Drive | 1 | 2235254 | A-2235254 |
| 14 | Alternator Drive | 1 | 2235180 | A-2235180 |



DEUTZ-FAHR M 1300 - M 1302 - 1302 H

| Belt No. |  | No. of Belts | OEM  Part No. | PIX  Part No. |
|----------|---|--------------|--|--|
| 0 | Reel Variator | 1 | 6215217 | A-6215217 |
| 0 | Cutting Mech. Countershaft - Knife Drive | 1 | 6210991 | A-6210991 |
| 1 | Straw Stripper Drum | 1 | 6215248 | A-6215248 |
| 2 | Grain Tank Discharge | 1 | 6215234 | A-6215234 |
| 3 | Threshing Vari-drive | 1 | 6215222 | A-6215222 |
| 3 | Threshing Vari-drive | 1 | 6215221 | A-6215221 |
| 4 | Countershaft Threshing Drum | 1 | 6256381 | A-6256381 |
| 4 | Countershaft Threshing Drum | 1 | 1210712015910 | A-1210712015910 |
| 5 | Shaker Shoe Fan Drive | 1 | 1139241 | A-1139241 |
| 6 | Fan Drive | 1 | 6210869 | A-6210869 |
| 7 | Chopper Transmission | 1 | 1129970 | A-1129970 |
| 8 | Chopper Transmission | 1 | 1210737011900 | A-1210737011900 |
| 9 | Grain Tank Clutch | 1 | 6211014 | A-6211014 |
| 10 | Feed Channel | 1 | 6215233 | A-6215233 |
| 11 | Shaker Transmission | 2 | 6256619 | A-6256619 |
| 12 | Returns Elevator | 1 | 6210917 | A-6210917 |
| 13 | Shaker Shoe Drive | 1 | 6256714 | A-6256714 |
| 14 | Main Drive | 2 | 6255583 | A-6255583 |
| 15 | Traction Vari-drive | 1 | 6215222 | A-6215222 |

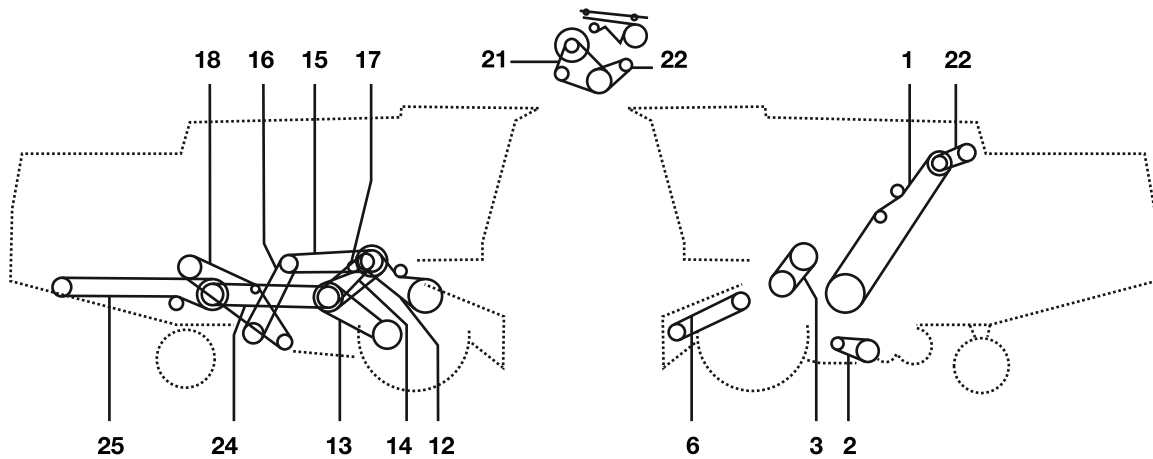

DEUTZ-FAHR M 1600 - M 1620 - M 1630

| Belt No. |  | No. of Belts | OEM  Part No. | PIX  Part No. |
|----------|---|--------------|--|--|
| 0 | - | 1 | 6211014 | A-6211014 |
| 0 | - | 1 | 6211034 | A-6211034 |
| 0 | - | 1 | 6215242 | A-6215242 |
| 0 | - | 1 | 1141613 | A-1141613 |
| 0 | - | 1 | 1141645 | A-1141645 |
| 0 | - | 2 | 2234343 | A-2234343 |
| 0 | - | 1 | 6210890 | A-6210890 |
| 0 | - | 1 | 6212866 | A-6212866 |
| 1 | STRAW STRIPPER DRUM | 1 | 6215259 | A-6215259 |
| 2 | GRAIN TANK DISCHARGE | 1 | 6215235 | A-6215235 |
| 3 | THRESHING DRUM VARIATOR | 1 | 6215222 | A-6215222 |
| 3 | THRESHING DRUM VARIATOR | 1 | 6215221 | A-6215221 |
| 4 | COUNTERSHAFT THRESHING DRUM | 1 | 6256546 | A-6256546 |
| 4 | COUNTERSHAFT THRESHING DRUM | 1 | 6256381 | A-6256381 |
| 5 | SHAKER SHOE FAN | 1 | 1139242 | A-1139242 |
| 6 | FAN DRIVE | 1 | 6210869 | A-6210869 |
| 7 | ENGINE - DYNAMO | 1 | 1139216 | A-1139216 |
| 8 | CHOPPER TRANSMISSION | 2 | 6257897 | A-6257897 |
| 9 | CHOPPER TRANSMISSION | 1 | 1210737011900 | A-1210737011900 |
| 10 | KNIFE DRIVE | 1 | 6212919 | A-6212919 |
| 11 | FEED CHANNEL | 1 | 6215233 | A-6215233 |
| 12 | SHAKER TRANSMISSION | 2 | 6256619 | A-6256619 |
| 13 | RETURNS ELEVATOR | 1 | 6210917 | A-6210917 |
| 14 | SHAKER SHOE DRIVE | 1 | 6256714 | A-6256714 |



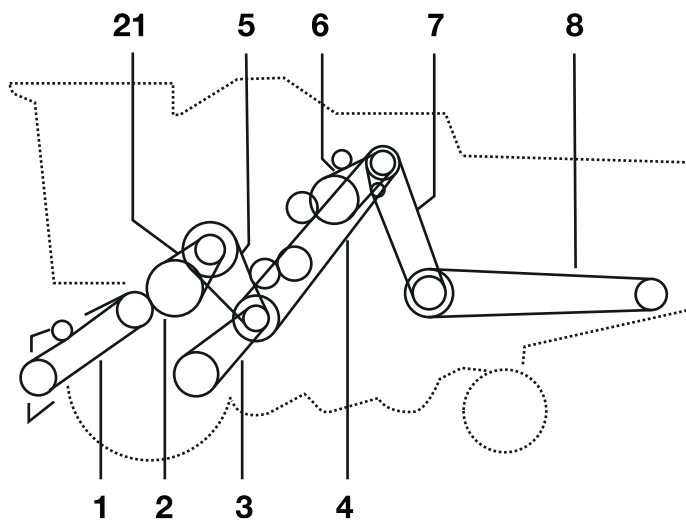
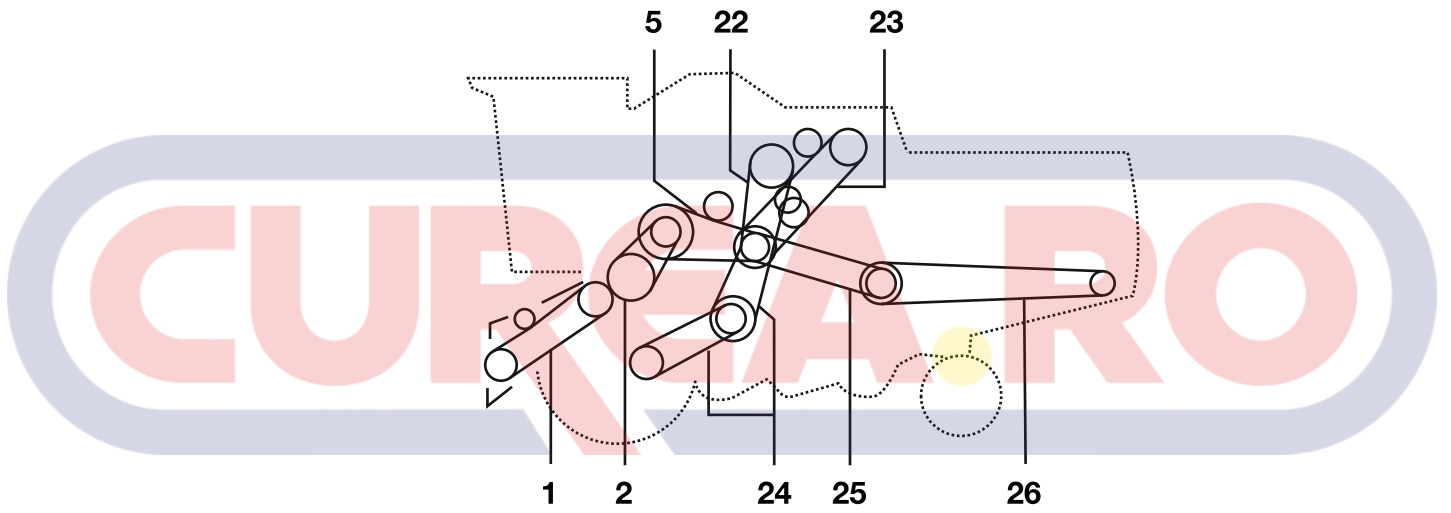
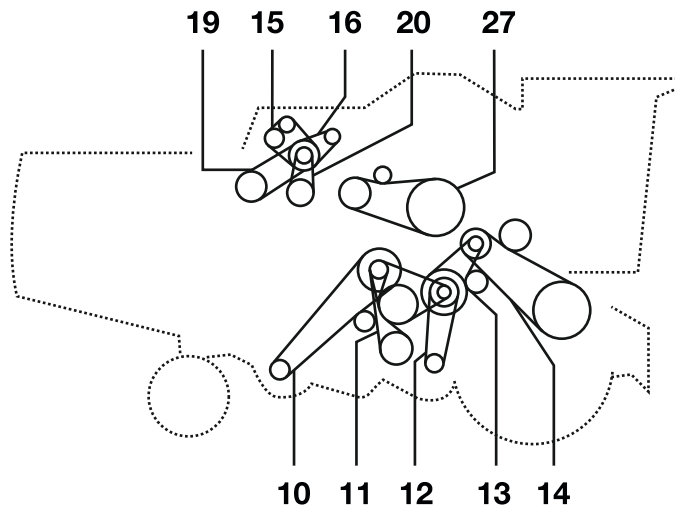

| Belt No. |  | No. of Belts | OEM  Part No. | PIX  Part No. |
|----------|---|--------------|--|--|
| 0 | Cutting Mechanical Countershaft - Knife Drive | 1 | 6210991 | A-6210991 |
| 0 | Reel Drive Variable Speed | 1 | 6215217 | A-6215217 |
| 1 | Main Drive | 1 | 6215243 | A-6215243 |
| 1 | Main Drive | 1 | 6285949 | A-6285949 |
| 2 | Countershaft - Fan Drive | 1 | 6215197 | A-6215197 |
| 3 | Straw Stripper Drum - Threshing Drum | 1 | 6215220 | A-6215220 |
| 6 | Feeder Channel - Countershaft | 1 | 6215205 | A-6215205 |
| 12 | Straw Stripper Drum - Feed Channel | 1 | 6215204 | A-6215204 |
| 13 | Countershaft - Travel Speed Variator | 1 | 6215216 | A-6215216 |
| 14 | Countershaft - Grain Tank | 1 | 6212924 | A-6212924 |
| 15 | Straw Stripper Drum - Tension Arm | 1 | 6210991 | A-6210991 |
| 16 | Return Elevator - Tension Arm | 1 | 6210991 | A-6210991 |
| 18 | Straw Walker - Grain Elevator | 1 | 6210927 | A-6210927 |
| 22 | Alternator Drive | 1 | 2235180 | A-2235180 |
| 24 | Chopper Drive | 1 | 6273236 | A-6273236 |



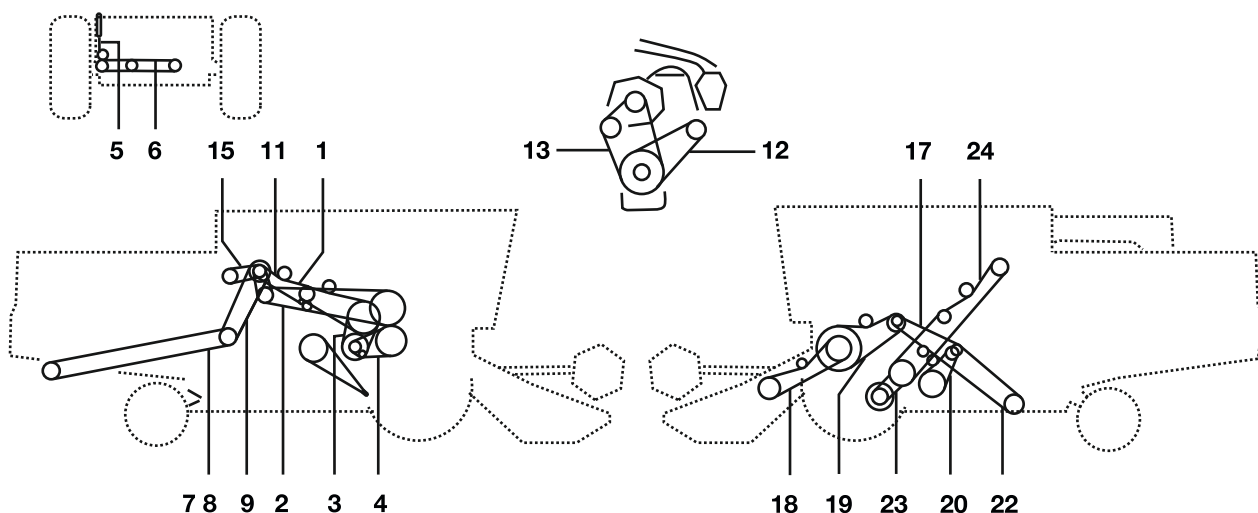

| Belt No. |  | No. of Belts | OEM  Part No. | PIX  Part No. |
|----------|---|--------------|--|--|
| 0 | Cutting Mech.countershaft - Knife Drive | 1 | 6210991 | A-6210991 |
| 0 | Reel Variator | 1 | 6215217 | A-6215217 |
| 1 | Feed Channel - Countershaft | 1 | 6215205 | A-6215205 |
| 2 | Straw Stripper Drum - Threshing Drum | 1 | 6215220 | A-6215220 |
| 3 | Driving Speed Variator / M2580-m2685 | 1 | 6215214 | A-6215214 |
| 4 | Engine - Countershaft / M2580.2680.2780h | 1 | 6215258 | A-6215258 |
| 4 | Engine - Countershaft / M2685.2780 | 1 | 6215262 | A-6215262 |
| 5 | Countershaft - Stripper Drum / M2580 - M2780h | 1 | 6215239 | A-6215239 |
| 5 | Countershaft - Straw Stripper Drum | 1 | 6215253 | A-6215253 |
| 7 | Engine - Chopper Transmission / W /-100 | 1 | 6210851 | A-6210851 |
| 7 | Engine - Chopper Transmission / +102 | 1 | 6215245 | A-6215245 |
| 8 | Chopper Transmission / M2580.2680 | 1 | 1139258 | A-1139258 |
| 8 | Chopper Transmission / M2685.2780h.2780 | 1 | 1139260 | A-1139260 |
| 10 | Countershaft - Return Elevator | 1 | 6210922 | A-6210922 |
| 10 | Countershaft - Returns Elevator / Maize | 1 | 6210923 | A-6210923 |
| 11 | Countershaft - Walker + Shaker Shoe Drive | 1 | 6215255 | A-6215255 |
| 12 | Countershaft - Fan | 1 | 6215202 | A-6215202 |
| 13 | Straw Stripper Drum - Countershaft | 1 | 6215240 | A-6215240 |
| 14 | Stripper Drum - Feed Channel / M2685.2780.2780h | 1 | 6215238 | A-6215238 |
| 14 | Stripper Drum - Feed Channel / M2480-m2680 | 1 | 6215203 | A-6215203 |
| 15 | Blower Drive / M2685 - 2780h.2780 | 2 | 2234343 | A-2234343 |
| 15 | Blower Drive / M2480 - M2680 | 1 | 2235532 | A-2235532 |
| 16 | Generator Drive | 1 | 2235180 | A-2235180 |
| 19 | Engine - Compressor | 1 | 1139233 | A-1139233 |
| 20 | Engine - Fan / M2480 - M2685 | 1 | 1139204 | A-1139204 |
| 22 | Countershaft - Grain Tank / M2480 | 1 | 6210975 | A-6210975 |
| 23 | Engine - Countershaft / M2480 | 1 | 6215257 | A-6215257 |
| 26 | Chopper Transmission - Chopper / M2480 | 1 | 1139259 | A-1139259 |
| 27 | Grain Tank Drive / + 437 M2580 - M2780h | 1 | 6210990 | A-6210990 |
| 27 | Grain Tank Drive / + 437 M2480 | 1 | 6210993 | A-6210993 |

DEUTZ-FAHR M 3280

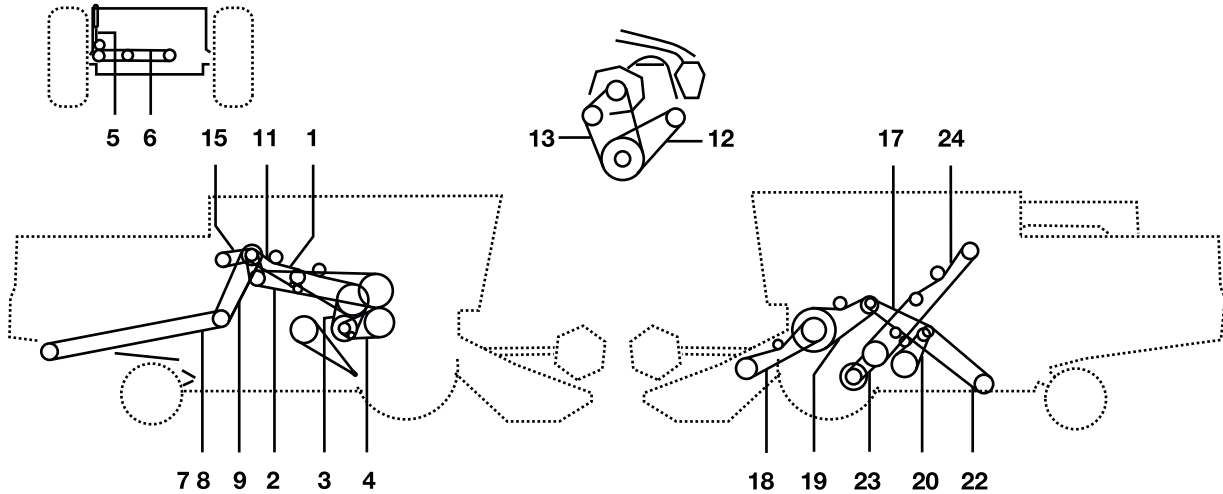

| Belt No. | | No. of Belts | OEM  Part No. | PIX  Part No. |
|----------|---|--------------|--|--|
| 1 | - | 1 | 1141591 | A-1141591 |
| 2 | - | 1 | 1141666 | A-1141666 |
| 3 | - | 1 | 6215222 | A-6215222 |
| 4 | - | 1 | 6256546 | A-6256546 |
| 5 | - | 1 | 1139241 | A-1139241 |
| 11 | - | 1 | 1141613 | A-1141613 |
| 17 | - | 2 | 6256619 | A-6256619 |
| 18 | - | 1 | 1141595 | A-1141595 |
| 18 | - | 1 | 1141615 | A-1141615 |
| 19 | - | 1 | 1141608 | A-1141608 |
| 20 | - | 1 | 6256714 | A-6256714 |
| 23 | - | 1 | 1141971 | A-1141971 |
| 24 | - | 1 | 6215244 | A-6215244 |





| Belt No. | | No. of Belts | OEM  Part No. | PIX  Part No. |
|----------|---|--------------|--|--|
| 0 | - | 1 | 1141971 | A-1141971 |
| 0 | Reel Variator | 1 | 6215217 | A-6215217 |
| 0 | Cutting Mech.countershaft - Knife Drive | 1 | 6210991 | A-6210991 |
| 0 | - | 2 | 6257898 | A-6257898 |
| 1 | Straw Stripper Drum | 1 | 1141591 | A-1141591 |
| 2 | Grain Tank Emptying | 1 | 1141666 | A-1141666 |
| 3 | Threshing Drum - Variator | 1 | 6215222 | A-6215222 |
| 4 | Countershaft - Thresing Drum | 1 | 6256546 | A-6256546 |
| 5 | Straw Walkers Transmission - Fan | 1 | 1139241 | A-1139241 |
| 6 | Fan - Cleaning Fan | 1 | 6210890 | A-6210890 |
| 8 | Straw Chopper - Straw Hood | 1 | 1141645 | A-1141645 |
| 9 | Engine - Chopper Transmission | 1 | 1210737011900 | A-1210737011900 |
| 11 | Engine - Grain Tank Clutch / M3570 | 1 | 6211014 | A-6211014 |
| 11 | Engine - Grain Tank Clutch / M3580 | 1 | 1141613 | A-1141613 |
| 12 | Generator Drive | 1 | 2235180 | A-2235180 |
| 13 | Blower Drive | 2 | 2234343 | A-2234343 |
| 15 | Compressor - Type Cooling Plant | 1 | 6212866 | A-6212866 |
| 17 | Straw Stripper Drum - Walkers Transmission | 2 | 6256619 | A-6256619 |
| 18 | Cutting Table Drive | 1 | 1141595 | A-1141595 |
| 18 | Maize Picking - Attachments Drive | 1 | 1141615 | A-1141615 |
| 19 | Straw Stripper Drum - Feed Channel | 1 | 1141608 | A-1141608 |
| 20 | Walkers Transmission - Shaker Shoe Transmission | 1 | 6256714 | A-6256714 |
| 22 | Walkers Transmission - Returnelevator | 1 | 6210917 | A-6210917 |
| 23 | Travel Speed Variator | 1 | 6215223 | A-6215223 |
| 24 | Engine - Countershaft | 1 | 6215244 | A-6215244 |

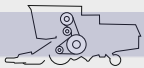

DEUTZ-FAHR M 3580

| Belt No. |  | No. of Belts | OEM  Part No. | PIX  Part No. |
|----------|---|--------------|--|--|
| 1 | - | 1 | 6211034 | A-6211034 |
| 2 | - | 1 | 6256714 | A-6256714 |
| 3 | - | 1 | 6256546 | A-6256546 |
| 4 | - | 2 | 6256619 | A-6256619 |
| 5 | - | 1 | 1141789 | A-1141789 |
| 6 | - | 1 | 1141591 | A-1141591 |
| 7 | - | 1 | 1141666 | A-1141666 |
| 8 | - | 1 | 1141613 | A-1141613 |
| 9 | - | 1 | 6215222 | A-6215222 |
| 10 | - | 1 | 1141971 | A-1141971 |
| 11 | - | 1 | 1139241 | A-1139241 |

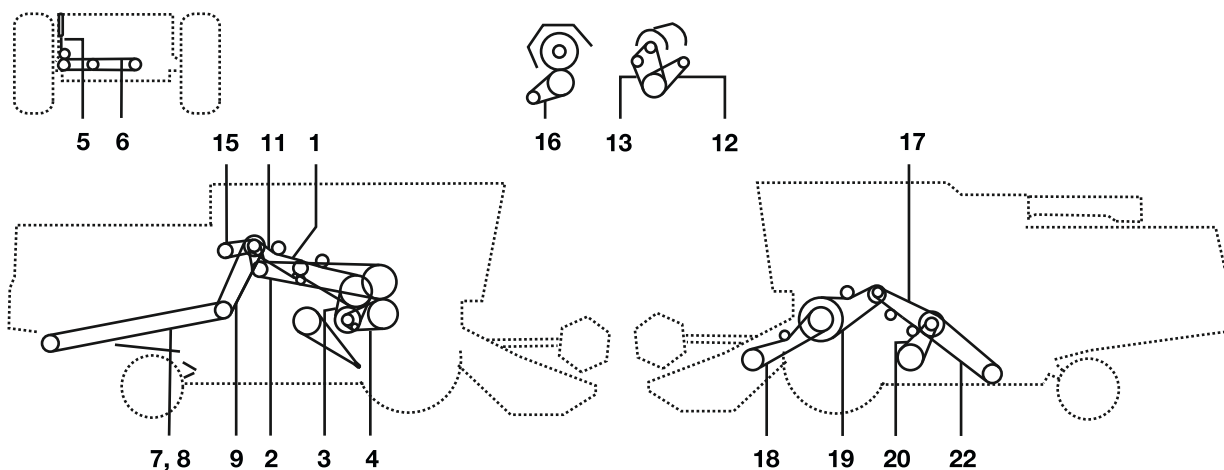

DEUTZ-FAHR M 3610

| Belt No. |  | No. of Belts | OEM  Part No. | PIX  Part No. |
|----------|--|--------------|--|--|
| 1 | Engine - Straw Stripper Drum / M3610 | 1 | 6211034 | A-6211034 |
| 2 | Reel Drive Variable Speed | 1 | 6215217 | A-6215217 |
| 3 | - | 1 | 2235177 | A-2235177 |
| 4 | - | 1 | 6256714 | A-6256714 |
| 5 | - | 1 | 6256546 | A-6256546 |
| 6 | - | 2 | 6256619 | A-6256619 |
| 7 | - | 1 | 1141789 | A-1141789 |
| 8 | Straw Chopper - Straw Hood / M3610 | 1 | 1141941 | A-1141941 |
| 9 | - | 1 | 1141591 | A-1141591 |
| 10 | Cutting Mechanical Countershaft - Knife Drive | 1 | 6210991 | A-6210991 |
| 11 | - | 1 | 1141666 | A-1141666 |
| 12 | - | 1 | 1141613 | A-1141613 |
| 13 | - | 1 | 6215222 | A-6215222 |
| 14 | - | 1 | 1139241 | A-1139241 |
| 15 | - | 1 | 1139242 | A-1139242 |
| 16 | - | 1 | 1141645 | A-1141645 |
| 17 | - | 2 | 2234343 | A-2234343 |
| 18 | - | 1 | 2235180 | A-2235180 |
| 19 | - | 1 | 6210890 | A-6210890 |
| 20 | - | 1 | 6212866 | A-6212866 |
| 21 | - | 2 | 6257898 | A-6257898 |





| Belt No. | | No. of Belts | OEM  Part No. | PIX  Part No. |
|----------|---|--------------|--|--|
| 0 | - | 1 | 1141510 | A-1141510 |
| 0 | - | 1 | 1141789 | A-1141789 |
| 0 | - | 1 | 1141530 | A-1141530 |
| 0 | - | 1 | 1141941 | A-1141941 |
| 0 | - | 1 | 1141591 | A-1141591 |
| 0 | - | 1 | 1141613 | A-1141613 |
| 0 | - | 1 | 6212866 | A-6212866 |
| 0 | - | 2 | 6257898 | A-6257898 |
| 1 | Engine - Straw Stripper Drum / M3610 | 1 | 6215248 | A-6215248 |
| 2 | Engine - Grain Tank Emptying | 1 | 1141666 | A-1141666 |
| 3 | Threshing Drum - Variator | 1 | 6215222 | A-6215222 |
| 4 | Countershaft - Threshing Drum | 1 | 6256546 | A-6256546 |
| 5 | Straw Walkers Transmission - Fan | 1 | 1139242 | A-1139242 |
| 6 | Fan - Cleaning Fan | 1 | 6210890 | A-6210890 |
| 8 | Straw Chopper - Straw Hood / M3610 | 1 | 1141645 | A-1141645 |
| 8 | Straw Chopper - Straw Hood / M3630/m3640 | 1 | 1141749 | A-1141749 |
| 9 | Engine - Chopper Transmission | 1 | 1210737011900 | A-1210737011900 |
| 11 | Engine - Grain Tank Clutch | 1 | 1141613 | A-1141613 |
| 12 | Generator Drive / Typ 6204 | 1 | 2235180 | A-2235180 |
| 13 | Blower Drive / +263 Type 6204 | 1 | 2235177 | A-2235177 |
| 13 | Blower Drive / -262 Type 6204 | 2 | 2234343 | A-2234343 |
| 15 | Compressor - Type Cooling Plant | 1 | 1139229 | A-1139229 |
| 16 | Generator Drive / Type 6208 | 1 | 2235713 | A-2235713 |
| 17 | Straw Stripper Drum - Walkers Transmission | 2 | 6256619 | A-6256619 |
| 18 | Cutting Table Drive | 1 | 1141595 | A-1141595 |
| 18 | Maize Picking Attachments Drive | 1 | 1141615 | A-1141615 |
| 19 | Straw Stripper Drum - Feed Channel | 1 | 1141608 | A-1141608 |
| 19 | Straw Stripper Drum - Feed Channel Maizeeq | 1 | 6215268 | A-6215268 |
| 20 | Walkers Transmission - Shaker Shoe Transmission | 1 | 6256714 | A-6256714 |
| 22 | Walkers Transmission - Returns Elevator | 1 | 6210917 | A-6210917 |

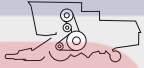

DEUTZ-FAHR POWERLINER 4030 - 4035

| Belt No. |  | No. of Belts | OEM  Part No. | PIX  Part No. |
|----------|---|--------------|--|--|
| 1 | - | 1 | 6215217 | A-6215217 |
| 2 | - | 1 | 2235254 | A-2235254 |
| 3 | - | 1 | 1145263 | A-1145263 |
| 4 | - | 1 | 1145262 | A-1145262 |
| 5 | - | 1 | 6215239 | A-6215239 |
| 6 | - | 1 | 1145260 | A-1145260 |
| 7 | - | 1 | 1141816 | A-1141816 |
| 8 | - | 1 | 1145226 | A-1145226 |
| 9 | - | 1 | 1145261 | A-1145261 |
| 10 | - | 1 | 6215258 | A-6215258 |
| 11 | - | 1 | 1141917 | A-1141917 |
| 12 | - | 1 | 1145224 | A-1145224 |
| 13 | - | 1 | 1141971 | A-1141971 |

DEUTZ-FAHR STARLINER 4040 - 4045

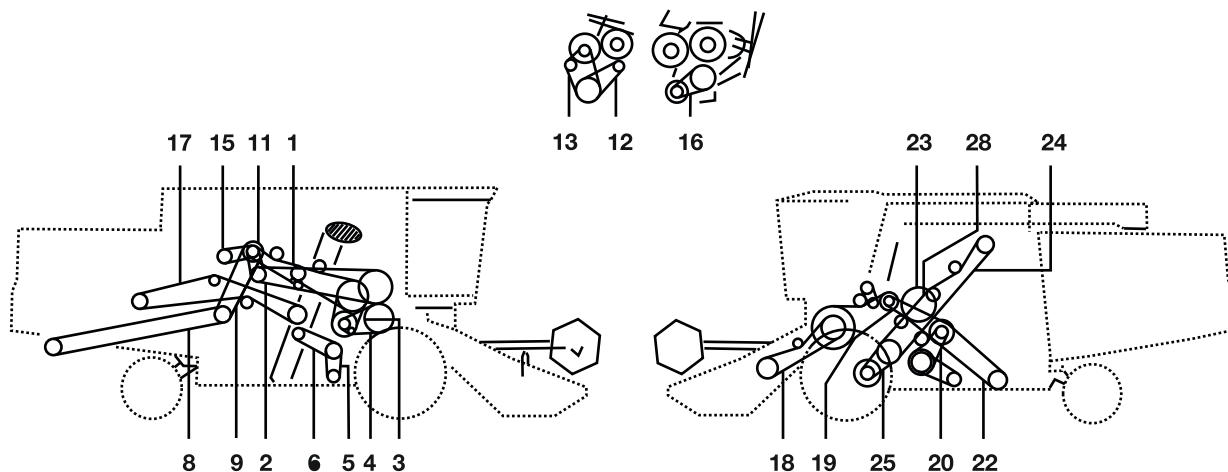
| Belt No. |  | No. of Belts | OEM  Part No. | PIX  Part No. |
|----------|--|--------------|---|---|
| 1 | - | 1 | 6256714 | A-6256714 |
| 2 | - | 1 | 6256546 | A-6256546 |
| 3 | - | 2 | 6256619 | A-6256619 |
| 4 | - | 1 | 1141608 | A-1141608 |
| 5 | - | 1 | 1141941 | A-1141941 |
| 6 | - | 1 | 1141591 | A-1141591 |
| 7 | - | 1 | 1141666 | A-1141666 |
| 8 | - | 1 | 1141613 | A-1141613 |
| 9 | - | 1 | 6215244 | A-6215244 |
| 10 | - | 1 | 6215222 | A-6215222 |
| 11 | - | 1 | 1145318 | A-1145318 |
| 12 | - | 1 | 1139241 | A-1139241 |
| 13 | - | 1 | 1141645 | A-1141645 |
| 14 | - | 1 | 1145331 | A-1145331 |
| 15 | - | 1 | 2235180 | A-2235180 |
| 16 | - | 1 | 6210890 | A-6210890 |
| 17 | - | 1 | 6212866 | A-6212866 |
| 18 | - | 2 | 6257898 | A-6257898 |

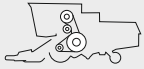



| Belt No. |  | No. of Belts | OEM  Part No. | PIX  Part No. |
|----------|---|--------------|--|--|
| 1 | Engine - Straw Stripper Drum | 1 | 1145050 | A-1145050 |
| 2 | Engine - Grain Tank Emptying | 1 | 1145055 | A-1145055 |
| 3 | Threshing Drum Variator drive | 1 | 1145026 | A-1145026 |
| 4 | Countershaft - Threshing Drum | 3 | 1145049 | A-1145049 |
| 5 | Fan Drive Variable Speed - Cleaning Fan | 1 | 1145097 | A-1145097 |
| 6 | Straw Walker - Variator | 1 | 1145202 | A-1145202 |
| 8 | For Straw Chopper Integrated | 1 | 1145187 | A-1145187 |
| 8 | For Straw Chopper Integrated | 1 | 1145188 | A-1145188 |
| 9 | Engine - Chopper Transmission | 2 | 6257898 | A-6257898 |
| 11 | Engine - Grain Tank Clutch | 1 | 1141613 | A-1141613 |
| 12 | Alternator Drive | 1 | 2235180 | A-2235180 |
| 13 | Blower Drive | 1 | 2235177 | A-2235177 |
| 13 | Blower Drive | 2 | 2234343 | A-2234343 |
| 15 | Compressor - Type Cooling Plant | 1 | 6212866 | A-6212866 |
| 17 | Straw Walker Drive | 1 | 1145053 | A-1145053 |
| 17 | Straw Walker Drive | 1 | 1145054 | A-1145054 |
| 18 | Picking - Attachments Drive (maize) | 1 | 1145025 | A-1145025 |
| 18 | Cutting Table Drive | 1 | 1143412 | A-1143412 |
| 18 | Cutting Table Drive | 1 | 1145211 | A-1145211 |
| 19 | Straw Stripper Drum - Feed Channel | 1 | 1141608 | A-1141608 |
| 19 | Equipment (maize) | 1 | 1141941 | A-1141941 |
| 20 | Shaker Shoe - Walker Transmission | 3 | 1143413 | A-1143413 |
| 21 | Straw Stripper Drum - Walker Transmission | 2 | 1145051 | A-1145051 |
| 22 | Return Elevator - Walker Transmission | 1 | 1145052 | A-1145052 |
| 23 | Straw Shipper Drum - Turbo - Separator | 2 | 1143410 | A-1143410 |
| 24 | Engine - Countershaft | 1 | 1145102 | A-1145102 |
| 25 | Travel Speed Variator | 1 | 1141944 | A-1141944 |

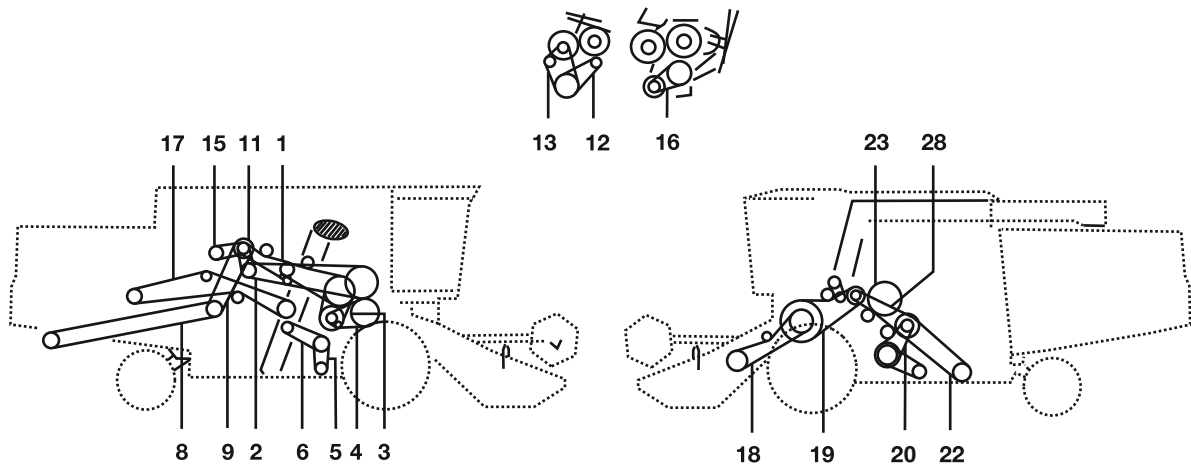

DEUTZ-FAHR TOPLINER

4070 - 4075- 4080 - 4090





| Belt No. |  | No. of Belts | OEM  Part No. | PIX  Part No. |
|----------|---|--------------|--|--|
| 1 | Straw Stripper Drum | 1 | 1145056 | A-1145056 |
| 1 | Straw Stripper Drum | 1 | 1145057 | A-1145057 |
| 2 | Engine - Grain Tank Emptying | 1 | 1145055 | A-1145055 |
| 3 | Threshing Drum Variator | 1 | 1145374 | A-1145374 |
| 4 | Countershaft Threshing Drum | 3 | 1145049 | A-1145049 |
| 5 | Fan Speed Variator - Cleaning Fan | 1 | 1145332 | A-1145332 |
| 5 | Fan Speed Variator - Cleaning Fan | 1 | 1145369 | A-1145369 |
| 6 | Straw Walkers Transmission - Variator | 1 | 1145331 | A-1145331 |
| 8 | Chopper Drive | 1 | 1145187 | A-1145187 |
| 8 | Chopper Drive | 1 | 1145188 | A-1145188 |
| 9 | Chopper Transmission (set) | 2 | 1145475 | A-1145475 |
| 9 | Chopper Transmission | 1 | 1145479 | A-1145479 |
| 11 | Grain Tank Clutch | 1 | 1141613 | A-1141613 |
| 12 | Generator Drive For 4070. 4075 | 1 | 2235180 | A-2235180 |
| 13 | Blower Drive For 4070/4075 | 1 | 2235177 | A-2235177 |
| 15 | Cooling Plant | 1 | 1145318 | A-1145318 |
| 15 | Cooling Plant | 1 | 6212866 | A-6212866 |
| 16 | Generator Drive For 4075/4080/4090 | 1 | 2237477 | A-2237477 |
| 17 | Straw Walker Drive | 1 | 1145053 | A-1145053 |
| 17 | Straw Walker Drive | 1 | 1145054 | A-1145054 |
| 18 | Cutting Table Drive | 1 | 1145025 | A-1145025 |
| 19 | Feed Channel | 1 | 1141941 | A-1141941 |
| 19 | Feed Channel | 1 | 1145329 | A-1145329 |
| 20 | Shaker Shoe Transmission | 3 | 1143413 | A-1143413 |
| 22 | Returns Elevator | 1 | 1145052 | A-1145052 |
| 23 | Straw Stripper Drum | 2 | 1143410 | A-1143410 |
| 24 | Straw Stripper Drum | 2 | 1145051 | A-1145051 |

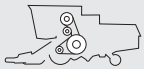

DEUTZ-FAHR TOPLINER 8XL

| Belt No. |  | No. of Belts | OEM  Part No. | PIX  Part No. |
|----------|---|--------------|--|--|
| 1 | - | 1 | 1145742 | A-1145742 |
| 2 | - | 1 | 1145744 | A-1145744 |
| 3 | - | 1 | 1145766 | A-1145766 |
| 4 | - | 2 | 1145980 | A-1145980 |
| 5 | - | 3 | 1145960 | A-1145960 |
| 6 | - | 2 | 1145789 | A-1145789 |
| 7 | - | 1 | 1145332 | A-1145332 |
| 8 | - | 1 | 1145724 | A-1145724 |
| 9 | - | 1 | 1145961 | A-1145961 |
| 11 | - | 1 | 1145877 | A-1145877 |
| 12 | - | 1 | 1145633 | A-1145633 |
| 13 | - | 1 | 1145865 | A-1145865 |
| 14 | - | 1 | 1145866 | A-1145866 |
| 15 | - | 1 | 1146027 | A-1146027 |
| 16 | - | 1 | 1141643 | A-1141643 |
| 18 | - | 1 | 1145699 | A-1145699 |
| 20 | - | 1 | 1145792 | A-1145792 |
| 21 | - | 2 | 1145959 | A-1145959 |
| 23 | - | 1 | 1145823 | A-1145823 |
| 23 | - | 1 | 1141904 | A-1141904 |
| 24 | - | 1 | 1180173 | A-1180173 |
| 26 | - | 1 | 1145921 | A-1145921 |



DRONNINGBORG D 500 - D 600

| Belt No. |  | No. of Belts | OEM  Part No. | PIX  Part No. |
|----------|---|--------------|--|--|
| 2 | Stripper Beater - Shaker | 1 | 41974300 | A-41974300 |
| 4 | Return Elevator Drive | 1 | 41932800 | A-41932800 |
| 6 | Fan Second Cleaner | 1 | 41974300 | A-41974300 |
| 9 | Filling Auger | 1 | 41964500 | A-41964500 |
| 14 | Hydraulic Pump Drive | 1 | 41902600 | A-41902600 |

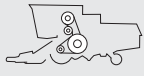

DRONNINGBORG D 900 - D950

| Belt No. |  | No. of Belts | OEM  Part No. | PIX  Part No. |
|----------|---|--------------|--|--|
| 2 | COUNTERSHAFT (PRIMARY) | 1 | 41996400 | A-41996400 |
| 3 | HYDRAULIC PUMP DRIVE | 1 | 41922200 | A-41922200 |
| 4 | GEAR BOX | 1 | 41994300 | A-41994300 |
| 5 | REEL DRIVE - VARIATOR PULLEY | 1 | 41962000 | A-41962000 |
| 6 | REEL DRIVE | 1 | 41939300 | A-41939300 |
| 7 | - | 1 | 41926100 | A-41926100 |
| 8 | COUNTERSHAFT DRIVE | 1 | 41903000 | A-41903000 |
| 9 | FEEDER AUGER | 1 | 41982400 | A-41982400 |
| 10 | MAIN BLOWER SHAKER BEATER | 1 | 41974300 | A-41974300 |
| 11 | FILLING AUGER | 1 | 41938900 | A-41938900 |
| 12 | THRESHING DRUM/FAN | 1 | 41974300 | A-41974300 |
| 14 | BEATER RETURN ELEVATOR | 1 | 41932800 | A-41932800 |
| 15 | - | 1 | 41904900 | A-41904900 |
| 17 | COUNTERSHAFT DRIVE | 1 | 41954800 | A-41954800 |
| 18 | COUNTERSHAFT DRIVE | 1 | 41995700 | A-41995700 |
| 19 | DRIVING GEAR FOR AUGER | 1 | 41955800 | A-41955800 |
| 20 | - | 1 | 41962600 | A-41962600 |



DRONNINGBORG D 1200 - D 1250

| Belt No. |  | No. of Belts | OEM  Part No. | PIX  Part No. |
|----------|---|--------------|--|--|
| 1 | Filling Elevator | 1 | 41935700 | A-41935700 |
| 3 | Elevator - Return Elevator Grain | 1 | 41932600 | A-41932600 |
| 4 | Countershaft Drive | 1 | 41998900 | A-41998900 |
| 6 | Driving Gear | 1 | 41996300 | A-41996300 |
| 7 | Awner Shaft | 1 | 41974300 | A-41974300 |
| 8 | Straw Shaker | 1 | 41966500 | A-41966500 |
| 10 | Feeder Shaft (upper) | 1 | 41937300 | A-41937300 |
| 11 | Knife Drive | 1 | 41964400 | A-41964400 |
| 12 | Feeder Auger | 1 | 41953700 | A-41953700 |
| 13 | Hydraulic Drive Variator | 1 | 41996500 | A-41996500 |
| 15 | Spring Loaded Drive Variator | 1 | 41994300 | A-41994300 |
| 16 | Straw Guide | 1 | 41926100 | A-41926100 |
| 20 | Straw Guide | 1 | 41996100 | A-41996100 |
| 21 | Main Fan Variable Speed Drive | 1 | 41928100 | A-41928100 |
| 22 | Main Fan | 1 | 41930300 | A-41930300 |
| 24 | Feeder Shaft (upper) | 1 | 41954800 | A-41954800 |



DRONNINGBORG D 1500 - D 1800

| Belt No. |  | No. of Belts | OEM  Part No. | PIX  Part No. |
|----------|---|--------------|--|--|
| 1 | Fan Drive | 1 | 41928100 | A-41928100 |
| 2 | Countershaft Drive | 1 | 41996400 | A-41996400 |
| 4 | Fan Drive | 1 | 41974300 | A-41974300 |
| 6 | Hydraulic Drive Variator | 1 | 41996500 | A-41996500 |
| 7 | Gear Box | 1 | 41994300 | A-41994300 |
| 10 | Shaker Shaft Drive | 1 | 41966900 | A-41966900 |
| 11 | Filling Auger | 1 | 41997600 | A-41997600 |
| 14 | Feeder Auger | 1 | 41953700 | A-41953700 |
| 22 | Threshing Drum Variator drive | 1 | 41981900 | A-41981900 |
| 29 | Crank Pulley | 1 | 41964400 | A-41964400 |



DRONNINGBORG D 1600 - D 1650

| Belt No. |  | No. of Belts | OEM  Part No. | PIX  Part No. |
|----------|---|--------------|--|--|
| 1 | FILLING ELEVATOR | 1 | 41935700 | A-41935700 |
| 3 | ELEVATOR - RETURN ELEVATOR GRAIN | 1 | 41932600 | A-41932600 |
| 4 | COUNTERSHAFT DRIVE | 1 | 41998900 | A-41998900 |
| 6 | DRIVING GEAR | 1 | 41996300 | A-41996300 |
| 7 | AWNER SHAFT | 1 | 41974300 | A-41974300 |
| 8 | STRAW SHAKER | 1 | 41966500 | A-41966500 |
| 10 | FEEDER SHAFT (UPPER) | 1 | 41937300 | A-41937300 |
| 11 | KNIFE DRIVE | 1 | 41964400 | A-41964400 |
| 12 | FEEDER AUGER | 1 | 41953700 | A-41953700 |
| 13 | HYDRAULIC DRIVE VARIATOR | 1 | 41996500 | A-41996500 |
| 15 | SPRING LOADED DRIVE VARIATOR | 1 | 41994300 | A-41994300 |
| 16 | STRAW GUIDE | 1 | 41926100 | A-41926100 |
| 20 | STRAW GUIDE | 1 | 41996100 | A-41996100 |
| 21 | MAIN FAN VARIABLE SPEED DRIVE | 1 | 41928100 | A-41928100 |
| 22 | MAIN FAN | 1 | 41930300 | A-41930300 |
| 24 | FEEDER SHAFT (UPPER) | 1 | 41954800 | A-41954800 |

DRONNINGBORG D 1600 - D 1650

| Belt No. |  | No. of Belts | OEM  Part No. | PIX  Part No. |
|----------|---|--------------|--|--|
| 1 | Filling Elevator | 1 | 41935700 | A-41935700 |
| 3 | Elevator - Return Elevator Grain | 1 | 41932600 | A-41932600 |
| 4 | Countershaft Drive | 1 | 41998900 | A-41998900 |
| 6 | Driving Gear | 1 | 41996300 | A-41996300 |
| 7 | Awner Shaft | 1 | 41974300 | A-41974300 |
| 8 | Straw Shaker | 1 | 41966500 | A-41966500 |
| 10 | Feeder Shaft (upper) | 1 | 41937300 | A-41937300 |
| 11 | Knife Drive | 1 | 41964400 | A-41964400 |
| 12 | Feeder Auger | 1 | 41953700 | A-41953700 |
| 13 | Hydraulic Drive Variator | 1 | 41996500 | A-41996500 |
| 15 | Spring Loaded Drive Variator | 1 | 41994300 | A-41994300 |
| 16 | Straw Guide | 1 | 41926100 | A-41926100 |
| 20 | Straw Guide | 1 | 41996100 | A-41996100 |
| 21 | Main Fan Variable Speed Drive | 1 | 41928100 | A-41928100 |
| 22 | Main Fan | 1 | 41930300 | A-41930300 |
| 24 | Feeder Shaft (upper) | 1 | 41954800 | A-41954800 |



DRONNINGBORG D 1900 (T27978)

| Belt No. |  | No. of Belts | OEM  Part No. | PIX  Part No. |
|----------|---|--------------|--|--|
| 1 | - | 1 | 41983500 | A-41983500 |
| 2 | - | 1 | 41964300 | A-41964300 |
| 5 | - | 1 | 41950600 | A-41950600 |
| 6 | - | 1 | 41950900 | A-41950900 |
| 9 | - | 1 | 41987200 | A-41987200 |
| 10 | - | 1 | 41935200 | A-41935200 |
| 12 | - | 1 | 41928900 | A-41928900 |
| 13 | - | 1 | 41942100 | A-41942100 |
| 14 | - | 1 | 41987300 | A-41987300 |
| 18 | - | 1 | 41935900 | A-41935900 |
| 19 | - | 1 | 41950400 | A-41950400 |
| 20 | - | 1 | 41929200 | A-41929200 |



DRONNINGBORG D 2250

| Belt No. |  | No. of Belts | OEM  Part No. | PIX  Part No. |
|----------|---|--------------|--|--|
| 1 | Feeder Auger | 1 | 41983500 | A-41983500 |
| 1 | Feeder Auger | 1 | 41983500 | A-41983500 |
| 2 | Countershaft Drive | 1 | 41964300 | A-41964300 |
| 2 | Knife Drive | 1 | 41964300 | A-41964300 |
| 3 | Feeder Shaft (upper) | 1 | 41955400 | A-41955400 |
| 3 | Countershaft Drive | 1 | 41955400 | A-41955400 |
| 5 | Eccentric Shaft Drive | 1 | 41982200 | A-41982200 |
| 5 | Elevator Drive Grain | 1 | 41954100 | A-41954100 |
| 6 | Center Shaft | 1 | 41987100 | A-41987100 |
| 6 | Straw Shaker - Return Auger | 1 | 41989900 | A-41989900 |
| 7 | Engine | 1 | 41994600 | A-41994600 |
| 7 | Intermediate Shaft | 1 | 41950000 | A-41950000 |
| 9 | Countershaft Drive | 1 | 41995600 | A-41995600 |
| 9 | Straw Guide | 1 | 41950000 | A-41950000 |
| 10 | Hydraulic Pump Drive | 1 | 41997200 | A-41997200 |
| 11 | Return Auger Drive | 1 | 41989900 | A-41989900 |
| 11 | Counter Drive | 1 | 41999700 | A-41999700 |
| 12 | Straw Cutter | 1 | 41999800 | A-41999800 |
| 13 | Straw Chopper Drive | 1 | 41940900 | A-41940900 |
| 13 | Straw Guide - Discharge Auger | 1 | 41995100 | A-41995100 |
| 14 | Main Fan | 1 | 41957600 | A-41957600 |
| 14 | Threshing Drum Variator drive | 1 | 41957800 | A-41957800 |
| 15 | Main Fan | 1 | 41950100 | A-41950100 |
| 16 | Main Fan Variable Speed Drive | 1 | 41950200 | A-41950200 |
| 17 | Main Fan | 1 | 41950300 | A-41950300 |

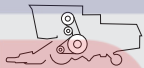

DRONNINGBORG D 2500

| Belt No. |  | No. of Belts | OEM  Part No. | PIX  Part No. |
|----------|---|--------------|--|--|
| 1 | Feeder Auger | 1 | 41983500 | A-41983500 |
| 2 | Knife Drive | 1 | 41964300 | A-41964300 |
| 3 | Countershaft Drive | 1 | 41955400 | A-41955400 |
| 5 | Eccentric Shaft Drive | 1 | 41982200 | A-41982200 |
| 6 | Straw Shaker - Return Auger | 1 | 41989900 | A-41989900 |
| 7 | Intermediate Shaft | 1 | 41950000 | A-41950000 |
| 9 | Countershaft Drive | 1 | 41995600 | A-41995600 |
| 10 | Hydraulic Pump Drive | 1 | 41997200 | A-41997200 |
| 11 | Counter Drive Straw Chopper | 1 | 41999700 | A-41999700 |
| 12 | Straw Cutter | 1 | 41999800 | A-41999800 |
| 13 | Straw Guide - Discharge Auger | 1 | 41995100 | A-41995100 |
| 14 | Threshing Drum Variator Drive | 1 | 41957800 | A-41957800 |
| 16 | Main Fan Variable Speed Drive | 1 | 41950200 | A-41950200 |
| 17 | Main Fan | 1 | 41950300 | A-41950300 |



DRONNINGBORG D 2600

| Belt No. |  | No. of Belts | OEM  Part No. | PIX  Part No. |
|----------|--|--------------|---|---|
| 1 | Feeder Auger | 1 | 41983500 | A-41983500 |
| 2 | Knife Drive | 1 | 41964300 | A-41964300 |
| 2 | Knife Drive | 1 | 41964300 | A-41964300 |
| 3 | Countershaft Drive | 1 | 41955400 | A-41955400 |
| 7 | Center Shaft | 1 | 41950000 | A-41950000 |
| 8 | Straw Guide | 1 | 41986800 | A-41986800 |
| 10 | Engine | 1 | 41997200 | A-41997200 |
| 11 | Counter Drive | 1 | 41999700 | A-41999700 |
| 12 | Straw Chopper Drive | 1 | 41999800 | A-41999800 |
| 14 | Threshing Drum Variator Drive | 1 | 41957800 | A-41957800 |
| 16 | Selector For Main Fan | 1 | 41950200 | A-41950200 |
| 17 | Main Fan | 1 | 41950300 | A-41950300 |



DRONNINGBORG D 3000 S

| Belt No. |  | No. of Belts | OEM  Part No. | PIX  Part No. |
|----------|---|--------------|--|--|
| 5 | Hydraulic Pump Drive | 1 | 41924900 | A-41924900 |
| 6 | Straw Chopper Drive | 1 | 41986500 | A-41986500 |
| 9 | Feeder Shaft (upper) | 1 | 41983900 | A-41983900 |
| 10 | Counter Drive Straw Chopper | 1 | 41955900 | A-41955900 |
| 14 | Intermediate Shaft | 1 | 41926600 | A-41926600 |
| 15 | Elevator Drive Grain | 1 | 41937600 | A-41937600 |
| 17 | Eccentric Shaft Drive | 1 | 41926300 | A-41926300 |
| 18 | Main Fan | 1 | 41930300 | A-41930300 |
| 19 | Eccentric Shaft Drive | 1 | 41934900 | A-41934900 |



DRONNINGBORG D 3000 S (35994)

| Belt No. |  | No. of Belts | OEM  Part No. | PIX  Part No. |
|----------|---|--------------|--|--|
| 1 | Return Auger (upper) | 1 | 41964300 | A-41964300 |
| 5 | Hydraulic Pump Drive | 1 | 41924900 | A-41924900 |
| 6 | Straw Chopper Drive | 1 | 41986500 | A-41986500 |
| 8 | Counter shaft Drive | 1 | 41992700 | A-41992700 |
| 9 | Feeder Shaft (upper) | 1 | 41983900 | A-41983900 |
| 10 | Counter Drive | 1 | 41955900 | A-41955900 |
| 14 | Intermediate Shaft | 1 | 41926600 | A-41926600 |
| 15 | Elevator Drive Grain | 1 | 41937600 | A-41937600 |
| 16 | Discharge Auger Shaft | 1 | 41984300 | A-41984300 |
| 17 | Eccentric Shaft Drive | 1 | 41926300 | A-41926300 |
| 18 | Main Fan | 1 | 41930300 | A-41930300 |
| 19 | Main Fan Selector | 1 | 41934900 | A-41934900 |
| 20 | Discharge Auger Shaft | 1 | 41980300 | A-41980300 |



DRONNINGBORG D 3000 S (F36006)

| Belt No. |  | No. of Belts | OEM  Part No. | PIX  Part No. |
|----------|---|--------------|--|--|
| 1 | Return Auger (upper) | 1 | 41964300 | A-41964300 |
| 5 | Hydraulic Pump Drive | 1 | 41924900 | A-41924900 |
| 6 | Straw Chopper Drive | 1 | 41986500 | A-41986500 |
| 8 | Countershaft Drive | 1 | 41992700 | A-41992700 |
| 9 | Feeder Shaft (upper) | 1 | 41983900 | A-41983900 |
| 11 | Counter Drive | 1 | 41955900 | A-41955900 |
| 14 | Intermediate Shaft | 1 | 41926600 | A-41926600 |
| 15 | Stripper Beater | 1 | 41937600 | A-41937600 |
| 16 | Discharge Auger Shaft | 1 | 41984300 | A-41984300 |
| 17 | Eccentric Shaft Drive | 1 | 41926300 | A-41926300 |
| 18 | Main Fan | 1 | 41930300 | A-41930300 |
| 19 | Main Fan Selector | 1 | 41934900 | A-41934900 |

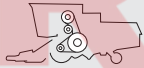

DRONNINGBORG D 3000 S (T36005)

| Belt No. |  | No. of Belts | OEM  Part No. | PIX  Part No. |
|----------|---|--------------|--|--|
| 5 | Hydraulic Pump Drive | 1 | 41924900 | A-41924900 |
| 6 | Straw Chopper Drive | 1 | 41986500 | A-41986500 |
| 8 | Countershaft Drive | 1 | 41992700 | A-41992700 |
| 9 | Feeder Shaft (upper) | 1 | 41983900 | A-41983900 |
| 11 | Counter Drive Straw Chopper | 1 | 41955900 | A-41955900 |
| 14 | Intermediate Shaft | 1 | 41926600 | A-41926600 |
| 15 | Elevator Drive Grain | 1 | 41937600 | A-41937600 |
| 16 | Discharge Auger Shaft | 1 | 41984300 | A-41984300 |
| 17 | Eccentric Shaft Drive | 1 | 41926300 | A-41926300 |
| 18 | Main Fan | 1 | 41930300 | A-41930300 |
| 19 | Eccentric Shaft Drive | 1 | 41934900 | A-41934900 |
| 19 | Awner Shaft | 1 | 41966500 | A-41966500 |



DRONNINGBORG D 4000 - D 4000 S (F35057 - T35832)

| Belt No. |  | No. of Belts | OEM  Part No. | PIX  Part No. |
|----------|---|--------------|--|--|
| 3 | Stripper Beater | 1 | 41992200 | A-41992200 |
| 4 | Hydraulic Pump Drive | 1 | 41924900 | A-41924900 |
| 5 | Propulsion Pump Drive | 1 | 41992100 | A-41992100 |
| 6 | Straw Chopper Drive | 1 | 41958500 | A-41958500 |
| 9 | Countershaft Drive | 1 | 41992700 | A-41992700 |
| 10 | Feeder Shaft (upper) | 1 | 41983900 | A-41983900 |
| 11 | Counter Drive Straw Chopper | 1 | 41955900 | A-41955900 |
| 12 | Straw Walker - Eccentric | 1 | 41972800 | A-41972800 |
| 13 | Awner Shaft - Fan Shaft | 1 | 41978500 | A-41978500 |
| 14 | Intermediate Shaft | 1 | 41926600 | A-41926600 |
| 15 | Elevator Drive Grain | 1 | 41937600 | A-41937600 |
| 16 | Discharge Auger Shaft | 1 | 41984300 | A-41984300 |
| 17 | Main Fan Selector | 1 | 41926300 | A-41926300 |
| 18 | Main Fan | 1 | 41930300 | A-41930300 |
| 19 | Eccentric Shaft Drive | 1 | 41934900 | A-41934900 |
| 20 | Threshing Drum Variator drive | 1 | 41980300 | A-41980300 |



DRONNINGBORG D 4000 - D 4000 S (F35833)

| Belt No. |  | No. of Belts | OEM  Part No. | PIX  Part No. |
|----------|---|--------------|--|--|
| 1 | Stripper Beater | 1 | 41964300 | A-41964300 |
| 2 | Filling Auger | 1 | 41972200 | A-41972200 |
| 2 | Filling Auger | 1 | 41972300 | A-41972300 |
| 3 | Stripper Beater | 1 | 41992200 | A-41992200 |
| 4 | Hydraulic Pump Drive | 1 | 41924900 | A-41924900 |
| 5 | Propulsion Pump Drive | 1 | 41992100 | A-41992100 |
| 6 | Straw Chopper Drive | 1 | 41958500 | A-41958500 |
| 9 | Counter shaft Drive | 1 | 41992700 | A-41992700 |
| 10 | Feeder Shaft (upper) | 1 | 41983900 | A-41983900 |
| 11 | Counter Drive Straw Chopper | 1 | 41955900 | A-41955900 |
| 12 | Straw Walker - Eccentric | 1 | 41972800 | A-41972800 |
| 13 | Awner Shaft - Fan Shaft | 1 | 41978500 | A-41978500 |
| 14 | Intermediate Shaft | 1 | 41926600 | A-41926600 |
| 15 | Elevator Drive Grain | 1 | 41937600 | A-41937600 |
| 16 | Discharge Auger Shaft | 1 | 41984300 | A-41984300 |
| 17 | Main Fan Selector | 1 | 41926300 | A-41926300 |
| 18 | Main Fan | 1 | 41930300 | A-41930300 |
| 19 | Eccentric Shaft Drive | 1 | 41934900 | A-41934900 |
| 20 | Threshing Drum Variator Drive | 1 | 41980300 | A-41980300 |

DRONNINGBORG D 4000 - D 4000 S (T35056)

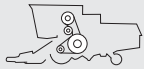

| Belt No. |  | No. of Belts | OEM  Part No. | PIX  Part No. |
|----------|---|--------------|--|--|
| 3 | Stripper Beater | 1 | 41992200 | A-41992200 |
| 4 | Hydraulic Pump Drive | 1 | 41924900 | A-41924900 |
| 5 | Propulsion Pump Drive | 1 | 41992100 | A-41992100 |
| 6 | Straw Chopper Drive | 1 | 41958500 | A-41958500 |
| 7 | Feeder Drum | 1 | 41953700 | A-41953700 |
| 8 | Counter shaft Drive | 1 | 41964400 | A-41964400 |
| 9 | Counter shaft Drive | 1 | 41992400 | A-41992400 |
| 10 | Feeder Shaft (upper) | 1 | 41983900 | A-41983900 |
| 11 | Counter Drive Straw Chopper | 1 | 41955900 | A-41955900 |
| 12 | Straw Walker - Eccentric | 1 | 41972800 | A-41972800 |
| 13 | Awner Shaft - Fan Shaft | 1 | 41958500 | A-41958500 |
| 14 | Intermediate Shaft | 1 | 41926600 | A-41926600 |
| 15 | Elevator Drive Grain | 1 | 41937600 | A-41937600 |
| 16 | Discharge Auger Shaft | 1 | 41984300 | A-41984300 |
| 17 | Main Fan Selector | 1 | 41926300 | A-41926300 |
| 18 | Main Fan | 1 | 41930300 | A-41930300 |
| 19 | Eccentric Shaft Drive | 1 | 41934900 | A-41934900 |
| 19 | Eccentric Shaft Drive | 1 | 41966500 | A-41966500 |

DRONNINGBORG D 4500

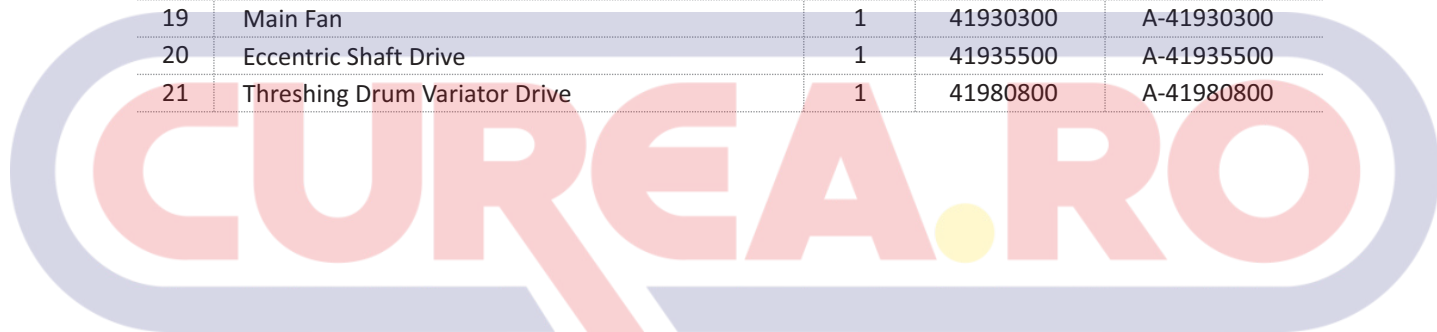
| Belt No. |  | No. of Belts | OEM  Part No. | PIX  Part No. |
|----------|---|--------------|--|--|
| 1 | Return Auger (upper) | 1 | 41964300 | A-41964300 |
| 2 | Filling Auger | 1 | 41972100 | A-41972100 |
| 3 | Stripper Beater | 1 | 41991600 | A-41991600 |
| 4 | Hydraulic Pump Drive | 1 | 41991400 | A-41991400 |
| 5 | Straw Chopper Drive | 1 | 41958500 | A-41958500 |
| 7 | Countershaft Drive | 1 | 41989100 | A-41989100 |
| 8 | Feeder Shaft (upper) | 1 | 41988900 | A-41988900 |
| 9 | Counter Drive Straw Chopper | 1 | 41955900 | A-41955900 |
| 10 | Straw Shaker - Eccentric Shaft | 1 | 41972800 | A-41972800 |
| 13 | Fan Shaft Awnershaft | 1 | 41978500 | A-41978500 |
| 14 | Intermediate Shaft | 1 | 41912300 | A-41912300 |
| 16 | Elevator Drive Grain | 1 | 41935700 | A-41935700 |
| 17 | Discharge Auger Shaft | 1 | 41988700 | A-41988700 |
| 18 | Main Fan Selector | 1 | 41926300 | A-41926300 |
| 19 | Main Fan | 1 | 41930300 | A-41930300 |
| 20 | Eccentric Shaft Drive | 1 | 41935500 | A-41935500 |
| 21 | Threshing Drum Variator Drive | 1 | 41980800 | A-41980800 |

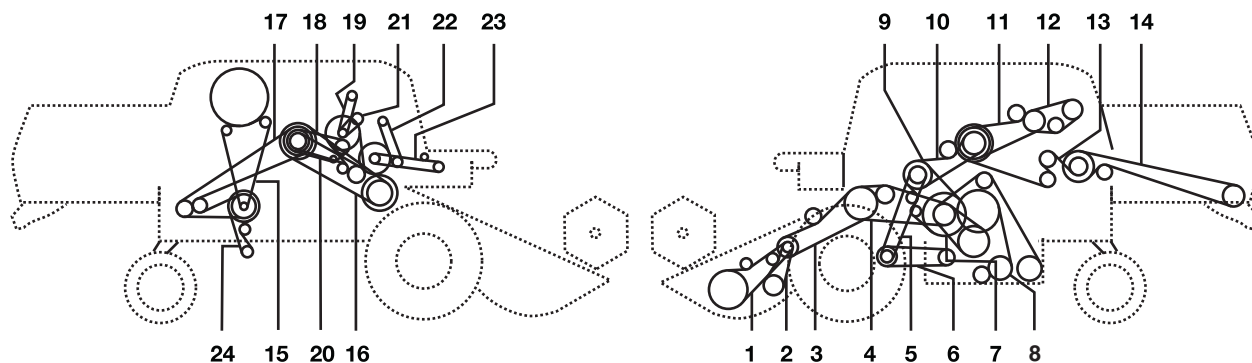

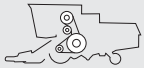

| Belt No. |  | No. of Belts | OEM  Part No. | PIX  Part No. |
|----------|---|--------------|--|--|
| 1 | Feeder Drum | 1 | 41983500 | A-41983500 |
| 2 | Crankshaft | 1 | 41964300 | A-41964300 |
| 3 | Countershaft Drive | 1 | 41993000 | A-41993000 |
| 4 | Feeder Shaft (upper) | 1 | 41993100 | A-41993100 |
| 5 | - | 1 | 41950600 | A-41950600 |
| 6 | - | 1 | 41950900 | A-41950900 |
| 7 | Eccentric Shaft Drive | 1 | 41982400 | A-41982400 |
| 8 | Straw Shaker Crank - Grain Auger | 1 | 41990100 | A-41990100 |
| 9 | Intermediate Shaft | 1 | 41987200 | A-41987200 |
| 10 | Stripper Beater | 1 | 41935200 | A-41935200 |
| 11 | Countershaft Drive | 1 | 41993400 | A-41993400 |
| 12 | Hydraulic Pump Drive | 1 | 41928900 | A-41928900 |
| 12 | Hydraulic Pump Drive | 1 | 41929000 | A-41929000 |
| 12 | Hydraulic Pump Drive | 1 | 41929200 | A-41929200 |
| 12 | Hydraulic Pump Drive | 1 | 41930200 | A-41930200 |
| 13 | Counter Drive Straw Chopper | 1 | 41942100 | A-41942100 |
| 14 | Straw Chopper Drive | 1 | 41987300 | A-41987300 |
| 15 | Awner Shaft | 1 | 41912400 | A-41912400 |
| 16 | Threshing Drum Variatordrive | 1 | 41980400 | A-41980400 |
| 16 | Threshing Drum Variatordrive | 1 | 41999200 | A-41999200 |
| 17 | Fan Shaft Awner Shaft | 1 | 41990200 | A-41990200 |
| 18 | Discharge Auger Shaft | 1 | 41935900 | A-41935900 |
| 18 | Discharge Auger Shaft | 2 | 41936200 | A-41936200 |
| 20 | Stripper Beater | 1 | 41982400 | A-41982400 |
| 24 | Seed Grinder | 1 | 41929100 | A-41929100 |
| 25 | Main Fan Selector - Main Fan | 1 | 41982200 | A-41982200 |
| 26 | Counter Drive Radiator | 1 | 41905300 | A-41905300 |
| 27 | Counter Drive Radiator | 1 | 41911000 | A-41911000 |

DRONNINGBORG D 7200

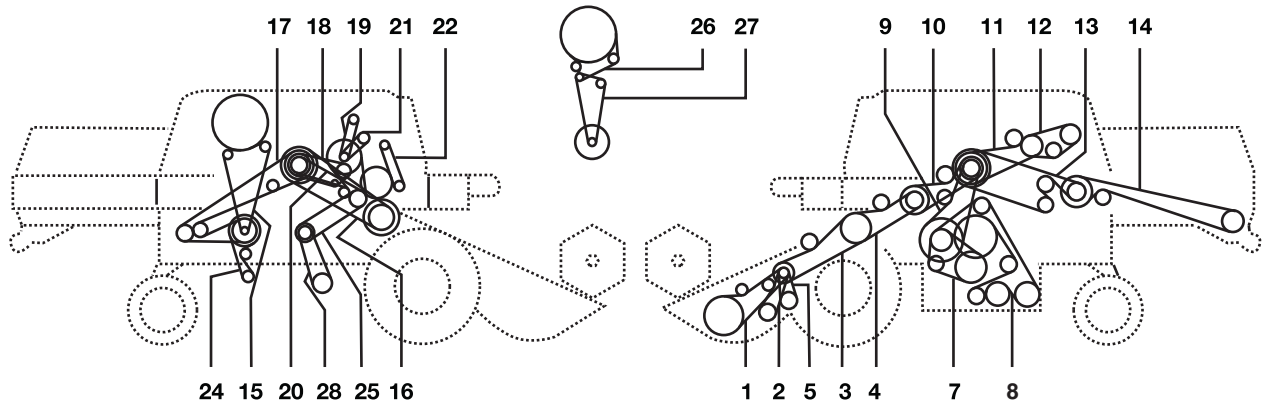

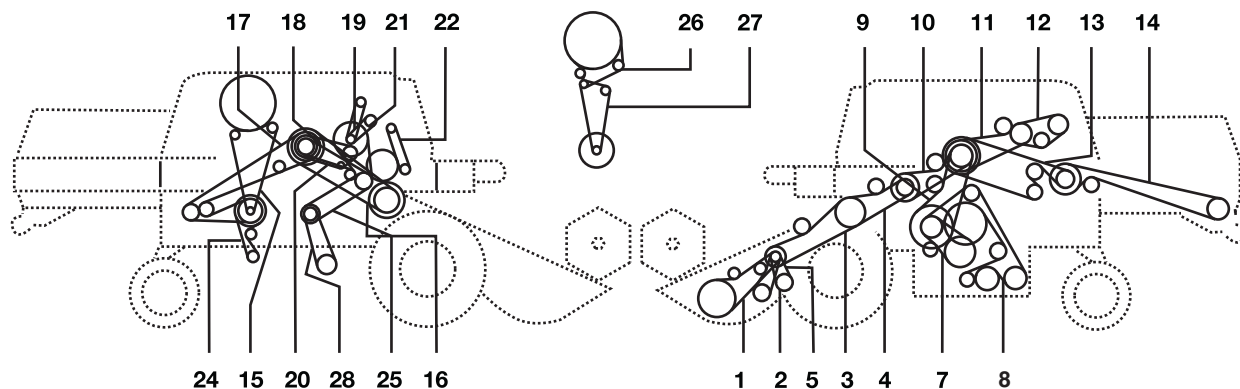

| Belt No. |  | No. of Belts | OEM  Part No. | PIX  Part No. |
|----------|---|--------------|--|--|
| 1 | Feeder Drum | 1 | 41983500 | A-41983500 |
| 1 | Feeder Drum | 1 | 41983500 | A-41983500 |
| 1 | Feeder Drum | 1 | 41983600 | A-41983600 |
| 2 | Crankshaft | 1 | 41964300 | A-41964300 |
| 2 | Crankshaft | 1 | 41963900 | A-41963900 |
| 3 | Countershaft Drive | 1 | 41989400 | A-41989400 |
| 3 | Countershaft Drive | 1 | 41989200 | A-41989200 |
| 4 | Feeder Shaft (upper) | 1 | 41991700 | A-41991700 |
| 7 | Eccentric Shaft Drive | 1 | 41982500 | A-41982500 |
| 7 | Eccentric Shaft Drive | 1 | 41982400 | A-41982400 |
| 8 | Straw Shaker Crank- Grain Auger | 1 | 41990100 | A-41990100 |
| 8 | Straw Shaker Crank- Grain Auger | 1 | 41990200 | A-41990200 |
| 8 | Straw Shaker Crank | 1 | 41990300 | A-41990300 |
| 8 | Straw Shaker Crank | 1 | 41990400 | A-41990400 |
| 9 | Intermediate Shaft | 1 | 41987800 | A-41987800 |
| 9 | Intermediate Shaft | 1 | 41988000 | A-41988000 |
| 10 | Stripper Beater | 3 | 41934800 | A-41934800 |
| 11 | Counter Selector | 1 | 41993400 | A-41993400 |
| 12 | Hydraulic Pump Drive | 1 | 41929000 | A-41929000 |
| 12 | Hydraulic Pump Drive | 1 | 41930200 | A-41930200 |
| 13 | Counter Drive Straw Chopper | 1 | 41942100 | A-41942100 |
| 14 | Straw Chopper Drive | 1 | 41987300 | A-41987300 |
| 15 | Awner Shaft | 1 | 41912300 | A-41912300 |
| 15 | Awner Shaft | 1 | 41912400 | A-41912400 |
| 16 | Threshing Drum Variator Drive | 1 | 41980400 | A-41980400 |
| 17 | Fan Shaft Awnershaft | 1 | 41990200 | A-41990200 |
| 17 | Fan Shaft Awnershaft | 1 | 41990400 | A-41990400 |
| 18 | Discharge Auger Shaft | 2 | 41936200 | A-41936200 |
| 20 | Stripper Beater | 1 | 41982500 | A-41982500 |
| 24 | Seed Grinder | 1 | 41929100 | A-41929100 |
| 25 | Main Fan Selector | 1 | 41987900 | A-41987900 |
| 26 | Counter Drive Radiator | 1 | 41905300 | A-41905300 |
| 27 | Counter Drive Radiator | 1 | 41911000 | A-41911000 |
| 28 | Main Fan | 1 | 41982200 | A-41982200 |
| 28 | Main Fan | 1 | 41987900 | A-41987900 |
| 28 | Main Fan | 1 | 41982100 | A-41982100 |





| Belt No. |  | No. of Belts | OEM  Part No. | PIX  Part No. |
|----------|---|--------------|--|--|
| 1 | Feeder Drum | 1 | 41983500 | A-41983500 |
| 1 | Feeder Drum | 1 | 41983500 | A-41983500 |
| 1 | Feeder Drum | 1 | 41983600 | A-41983600 |
| 2 | Crankshaft | 1 | 41964300 | A-41964300 |
| 2 | Crankshaft | 1 | 41963900 | A-41963900 |
| 3 | Countershaft Drive | 1 | 41989400 | A-41989400 |
| 3 | Countershaft Drive | 1 | 41989200 | A-41989200 |
| 4 | Feeder Shaft (upper) | 1 | 41991700 | A-41991700 |
| 7 | Eccentric Shaft Drive | 1 | 41982500 | A-41982500 |
| 7 | Eccentric Shaft Drive | 1 | 41982400 | A-41982400 |
| 8 | Straw Shaker Crank - Grain Auger | 1 | 41990100 | A-41990100 |
| 8 | Straw Shaker Crank - Grain Auger | 1 | 41990200 | A-41990200 |
| 8 | Auger - Return Auger Grain (lower) | 1 | 41990300 | A-41990300 |
| 8 | Straw Shaker Crank - Grain Auger | 1 | 41990400 | A-41990400 |
| 9 | Intermediate Shaft | 1 | 41987800 | A-41987800 |
| 9 | Intermediate Shaft | 1 | 41988000 | A-41988000 |
| 10 | Stripper Beater | 3 | 41934800 | A-41934800 |
| 11 | Countershaft Drive | 1 | 41993400 | A-41993400 |
| 12 | Engine - Hydraulic Pump | 1 | 41929000 | A-41929000 |
| 12 | Hydraulic Pump Drive | 1 | 41930200 | A-41930200 |
| 13 | Counter Drive Straw Chopper | 1 | 41942100 | A-41942100 |
| 14 | Straw Chopper Drive | 1 | 41987300 | A-41987300 |
| 15 | Awner Shaft | 1 | 41912300 | A-41912300 |
| 15 | Awner Shaft | 1 | 41912400 | A-41912400 |
| 16 | Threshing Drum Variator drive | 1 | 41980900 | A-41980900 |
| 17 | Fan Shaft Awner Shaft | 1 | 41990200 | A-41990200 |
| 17 | Fan Shaft Awner Shaft | 1 | 41990400 | A-41990400 |
| 18 | Discharge Auger Shaft | 2 | 41936200 | A-41936200 |
| 20 | Stripper Beater | 1 | 41982500 | A-41982500 |
| 24 | Seed Grinder | 1 | 41929100 | A-41929100 |
| 25 | Main Fan Selector | 1 | 41987900 | A-41987900 |
| 26 | Counter Drive Radiator | 1 | 41905300 | A-41905300 |
| 27 | Counter Drive Radiator | 1 | 41911000 | A-41911000 |
| 28 | Main Fan | 1 | 41982200 | A-41982200 |
| 28 | Main Fan | 1 | 41987900 | A-41987900 |
| 28 | Main Fan Selector - Main Fan | 1 | 41982100 | A-41982100 |

DRONNINGBORG D 8000 - D 8000 S

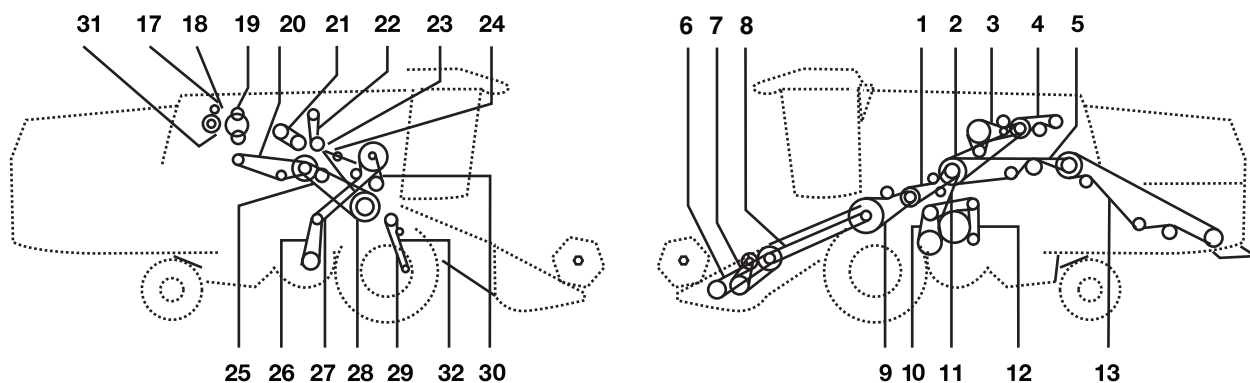
| Belt No. |  | No. of Belts | OEM  Part No. | PIX  Part No. |
|----------|---|--------------|--|--|
| 1 | Feeder Drum | 1 | 41983500 | A-41983500 |
| 1 | Feeder Drum | 1 | 41983500 | A-41983500 |
| 1 | Feeder Drum | 1 | 41983600 | A-41983600 |
| 2 | Crankshaft | 1 | 41964300 | A-41964300 |
| 2 | Crankshaft | 1 | 41964300 | A-41964300 |
| 3 | Countershaft Drive | 1 | 41993000 | A-41993000 |
| 4 | Feeder Shaft (upper) | 1 | 41993100 | A-41993100 |
| 5 | - | 1 | 41950600 | A-41950600 |
| 6 | - | 1 | 41950900 | A-41950900 |
| 7 | Eccentric Shaft Drive | 1 | 41982400 | A-41982400 |
| 8 | Straw Shaker Crank- Grain Auger | 1 | 41990100 | A-41990100 |
| 9 | Intermediate Shaft | 1 | 41987200 | A-41987200 |
| 10 | Stripper Beater | 1 | 41935200 | A-41935200 |
| 11 | Counter Selector | 1 | 41993400 | A-41993400 |
| 12 | Hydraulic Pump Drive | 1 | 41929000 | A-41929000 |
| 12 | Hydraulic Pump Drive | 1 | 41930200 | A-41930200 |
| 12 | Hydraulic Pump Drive | 1 | 41930300 | A-41930300 |
| 13 | Counter Drive Straw Chopper | 1 | 41942100 | A-41942100 |
| 14 | Straw Chopper Drive | 1 | 41987600 | A-41987600 |
| 15 | Awner Shaft | 1 | 41912400 | A-41912400 |
| 16 | Threshing Drum Variator Drive | 1 | 41980400 | A-41980400 |
| 16 | Threshing Drum Variator Drive | 1 | 41999200 | A-41999200 |
| 17 | Fan Shaft Awnershaft | 1 | 41990200 | A-41990200 |
| 18 | Discharge Auger Shaft | 1 | 41935900 | A-41935900 |
| 18 | Discharge Auger Shaft | 2 | 41936200 | A-41936200 |
| 20 | Stripper Beater | 1 | 41982400 | A-41982400 |
| 24 | Seed Grinder | 1 | 41929100 | A-41929100 |
| 25 | Main Fan Selector | 1 | 41982200 | A-41982200 |
| 26 | Counter Drive Radiator | 1 | 41905300 | A-41905300 |
| 27 | Counter Drive Radiator | 1 | 41911000 | A-41911000 |



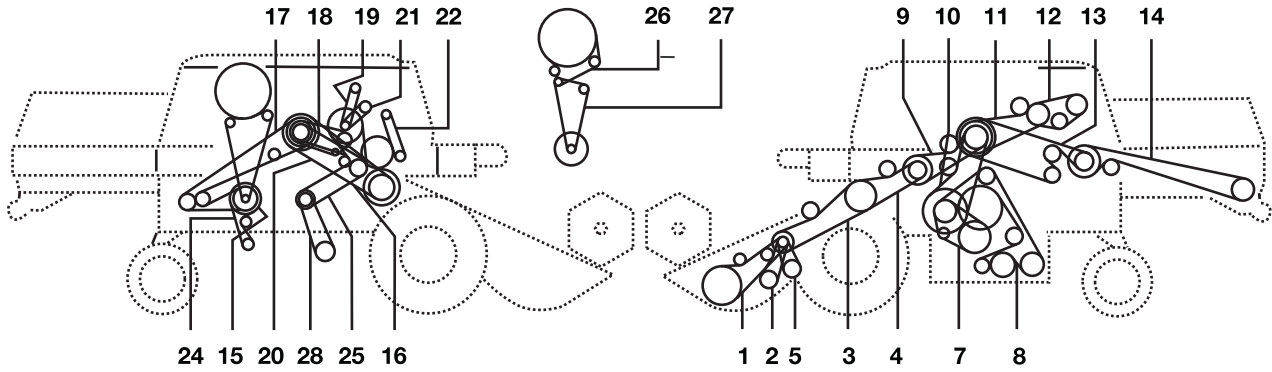

| Belt No. |  | No. of Belts | OEM  Part No. | PIX  Part No. |
|----------|---|--------------|--|--|
| 1 | Stripper Beater | 3 | 41934800 | A-41934800 |
| 2 | Countershaft Drive | 1 | 41990051 | A-41990051 |
| 3 | Discharge Auger Shaft | 1 | 41990050 | A-41990050 |
| 5 | Intermediate Shaft - Straw Chopper | 1 | 41942200 | A-41942200 |
| 6 | Knife Drive | 1 | 41985600 | A-41985600 |
| 9 | Feeder Shaft (upper) | 1 | 41991700 | A-41991700 |
| 10 | Eccentric Shaft Drive | 1 | 41982100 | A-41982100 |
| 11 | Intermediate Shaft | 1 | 41984100 | A-41984100 |
| 12 | Straw Shaker Crank | 1 | 41990068 | A-41990068 |
| 13 | Straw Chopper Drive | 1 | 41978400 | A-41978400 |
| 17 | Air Conditioning Compressor Drive | 1 | 41909000 | A-41909000 |
| 17 | Air Conditioning Compressor Drive | 1 | 41991000 | A-41991000 |
| 18 | Suction Strainer - Air Conditioning | 1 | 41991200 | A-41991200 |
| 19 | Suction Strainer | 1 | 41990009 | A-41990009 |
| 20 | Dust Extractor | 1 | 41936700 | A-41936700 |
| 21 | Discharge Auger Shaft | 1 | 41979600 | A-41979600 |
| 23 | Intermediate Shaft - Fill Elevator | 1 | 41950100 | A-41950100 |
| 25 | Countershaft - Grain Separator | 1 | 41982100 | A-41982100 |
| 26 | Main Fan | 1 | 41982100 | A-41982100 |
| 27 | Main Fan Variable Speed Drive | 1 | 41987900 | A-41987900 |
| 28 | Threshing Drum Variator drive | 1 | 41980900 | A-41980900 |
| 29 | Discharge Auger Shaft | 1 | 41950400 | A-41950400 |

DRONNINGBORG D 8500





| Belt No. |  | No. of Belts | OEM  Part No. | PIX  Part No. |
|----------|---|--------------|--|--|
| 1 | Feeder Drum | 1 | 41983500 | A-41983500 |
| 1 | Feeder Drum | 1 | 41983600 | A-41983600 |
| 2 | Crankshaft | 1 | 41964300 | A-41964300 |
| 2 | Crankshaft | 1 | 41963900 | A-41963900 |
| 3 | Countershaft Drive | 1 | 41989400 | A-41989400 |
| 3 | Countershaft Drive | 1 | 41989200 | A-41989200 |
| 4 | Feeder Shaft (upper) | 1 | 41991700 | A-41991700 |
| 7 | Eccentric Shaft Drive | 1 | 41982500 | A-41982500 |
| 7 | Eccentric Shaft Drive | 1 | 41982400 | A-41982400 |
| 8 | Straw Shaker Crank | 1 | 41990069 | A-41990069 |
| 8 | Straw Shaker Crank- Grain Auger | 1 | 41990100 | A-41990100 |
| 8 | Straw Shaker Crank | 1 | 41990300 | A-41990300 |
| 8 | Straw Shaker Crank | 1 | 41990400 | A-41990400 |
| 9 | Intermediate Shaft | 1 | 41987800 | A-41987800 |
| 9 | Intermediate Shaft | 1 | 41988000 | A-41988000 |
| 10 | Stripper Beater | 3 | 41934800 | A-41934800 |
| 11 | Counter Selector | 1 | 41991300 | A-41991300 |
| 11 | Counter Selector | 1 | 41993400 | A-41993400 |
| 12 | Hydraulic Pump Drive | 1 | 41930200 | A-41930200 |
| 13 | Counter Drive Straw Chopper | 1 | 41942100 | A-41942100 |
| 14 | Straw Chopper Drive | 1 | 41987300 | A-41987300 |
| 15 | Awner Shaft | 1 | 41912300 | A-41912300 |
| 15 | Awner Shaft | 1 | 41912400 | A-41912400 |
| 16 | Threshing Drum Variator Drive | 1 | 41980400 | A-41980400 |
| 17 | Fan Shaft Awnershaft | 1 | 41990069 | A-41990069 |
| 17 | Fan Shaft Awnershaft | 1 | 41990200 | A-41990200 |
| 18 | Discharge Auger Shaft | 2 | 41936200 | A-41936200 |
| 20 | Stripper Beater | 1 | 41982400 | A-41982400 |
| 24 | Seed Grinder | 1 | 41929100 | A-41929100 |
| 25 | Main Fan Selector | 1 | 41987900 | A-41987900 |
| 26 | Counter Drive Radiator | 1 | 41905300 | A-41905300 |
| 27 | Counter Drive Radiator | 1 | 41911000 | A-41911000 |
| 28 | Main Fan Selector - Mainfan | 1 | 41982200 | A-41982200 |
| 28 | Main Fan Selector - Mainfan | 1 | 41987900 | A-41987900 |
| 28 | Main Fan Selector - Mainfan | 1 | 41982100 | A-41982100 |

DRONNINGBORG D 8900

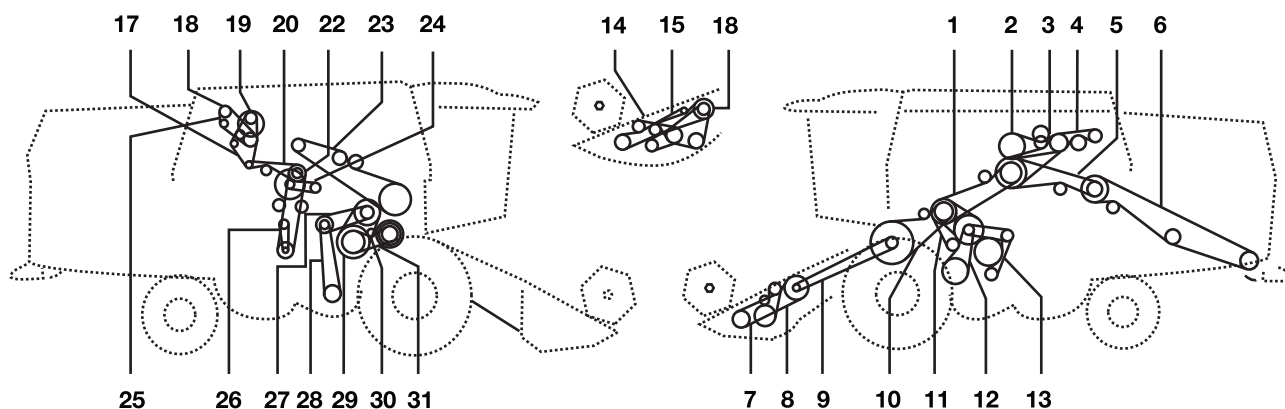

| Belt No. |  | No. of Belts | OEM  Part No. | PIX  Part No. |
|----------|---|--------------|--|--|
| 1 | - | 2 | 41933700 | A-41933700 |
| 2 | - | 1 | 41979400 | A-41979400 |
| 3 | - | 1 | 41979100 | A-41979100 |
| 5 | - | 1 | 41979600 | A-41979600 |
| 6 | - | 1 | 41978900 | A-41978900 |
| 7 | - | 1 | 41983500 | A-41983500 |
| 7 | - | 1 | 41983600 | A-41983600 |
| 8 | - | 1 | 41963900 | A-41963900 |
| 11 | - | 1 | 41979800 | A-41979800 |
| 12 | - | 1 | 41990001 | A-41990001 |
| 13 | - | 2 | 41933700 | A-41933700 |
| 14 | - | 1 | 41979000 | A-41979000 |
| 17 | - | 1 | 41911000 | A-41911000 |
| 18 | - | 1 | 41991200 | A-41991200 |
| 19 | - | 1 | 41986100 | A-41986100 |
| 20 | - | 1 | 41998800 | A-41998800 |
| 22 | - | 2 | 41937500 | A-41937500 |
| 23 | - | 1 | 41978800 | A-41978800 |
| 27 | - | 1 | 41981200 | A-41981200 |
| 28 | - | 1 | 41981100 | A-41981100 |
| 29 | - | 1 | 41981000 | A-41981000 |
| 30 | - | 1 | 41985200 | A-41985200 |
| 31 | - | 1 | 41985300 | A-41985300 |

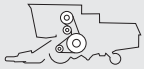
DRONNINGBORG D 9000





| Belt No. |  | No. of Belts | OEM  Part No. | PIX  Part No. |
|----------|---|--------------|--|--|
| 1 | Countershaft Drive | 1 | 41979900 | A-41979900 |
| 2 | Discharge Auger Shaft | 1 | 41979400 | A-41979400 |
| 3 | Diesel Engine | 1 | 41979100 | A-41979100 |
| 4 | Traction Pump | 1 | 41934200 | A-41934200 |
| 5 | Intermediate Shaft - Straw Chopper | 1 | 41979600 | A-41979600 |
| 6 | Straw Chopper Drive | 1 | 41978900 | A-41978900 |
| 7 | Knife Drive | 1 | 41986200 | A-41986200 |
| 7 | Knife Drive | 1 | 41985600 | A-41985600 |
| 10 | Feeder Shaft (upper) | 1 | 41979800 | A-41979800 |
| 11 | Stripper Beater | 1 | 41990001 | A-41990001 |
| 12 | Eccentric Shaft - Intermediateshaft | 2 | 41933700 | A-41933700 |
| 13 | Straw Shaker Crank | 1 | 41979000 | A-41979000 |
| 14 | Knife Drive | 1 | 41986300 | A-41986300 |
| 17 | Diesel Engine | 1 | 41911000 | A-41911000 |
| 18 | Compressor Drive | 1 | 41991200 | A-41991200 |
| 19 | Intermediate Shaft - Fill Elevator | 1 | 41986100 | A-41986100 |
| 20 | Dust Extractor - Countershaft | 1 | 41998800 | A-41998800 |
| 22 | Countershaft Drive | 2 | 41937500 | A-41937500 |
| 23 | Discharge Auger Shaft | 1 | 41978800 | A-41978800 |
| 23 | Discharge Auger Shaft | 1 | 41979200 | A-41979200 |
| 25 | Air Conditioning Compressor Drive | 1 | 41909000 | A-41909000 |
| 27 | Main Fan Radiator | 1 | 41981200 | A-41981200 |
| 28 | Main Fan | 1 | 41981100 | A-41981100 |
| 29 | Intermediate Shaft - Variator Drive | 1 | 41981000 | A-41981000 |
| 30 | Intermediate Shaft - Variator Drive | 1 | 41985200 | A-41985200 |
| 31 | Threshing Drum Variator Drive | 1 | 41985300 | A-41985300 |



FENDT 5250

| Belt No. |  | No. of Belts | OEM  Part No. | PIX  Part No. |
|----------|---|--------------|--|--|
| 1 | - | 1 | 340433422 | A-340433422 |
| 2 | - | 1 | 340433253 | A-340433253 |
| 3 | - | 1 | 340433197 | A-340433197 |
| 4 | - | 1 | 344311227 | A-344311227 |
| 5 | - | 1 | 344312128 | A-344312128 |
| 6 | - | 1 | 340433984 | A-340433984 |
| 7 | - | 1 | 340435152 | A-340435152 |
| 8 | - | 1 | 344311318 | A-344311318 |
| 9 | - | 1 | 340433539 | A-340433539 |
| 10 | - | 1 | 340433474 | A-340433474 |
| 11 | - | 1 | 344311131 | A-344311131 |
| 12 | - | 1 | 344311151 | A-344311151 |
| 13 | - | 1 | 344311123 | A-344311123 |
| 14 | - | 1 | 340435150 | A-340435150 |
| 15 | - | 1 | 344311117 | A-344311117 |
| 16 | - | 1 | 340433154 | A-340433154 |
| 17 | - | 1 | 340433253 | A-340433253 |
| 18 | - | 1 | 340434138 | A-340434138 |
| 19 | - | 1 | 340433423 | A-340433423 |

FENDT 6300 - 6330

| Belt No. |  | No. of Belts | OEM  Part No. | PIX  Part No. |
|----------|---|--------------|--|--|
| 1 | Drum Drive | 1 | 41979900 | A-41979900 |
| 2 | Threshing Drum Variator Drive | 1 | 41978000 | A-41978000 |
| 3 | Disposal Shaft Drive | 1 | 41978100 | A-41978100 |
| 4 | Thresher Drive (secondary) | 2 | 41937800 | A-41937800 |
| 5 | Movement Drive | 1 | 41990057 | A-41990057 |
| 6 | Crusher Drive | 1 | 41979600 | A-41979600 |

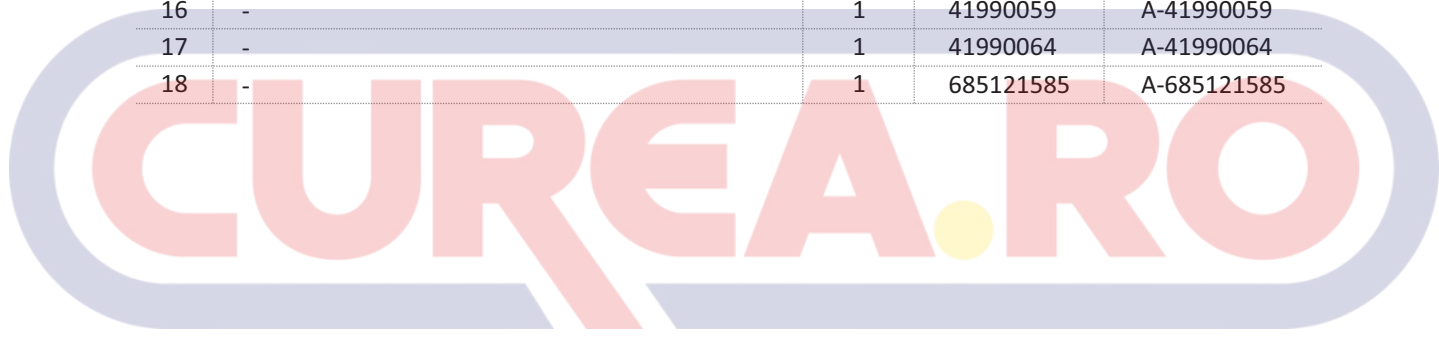

FENDT 8300

| Belt No. |  | No. of Belts | OEM  Part No. | PIX  Part No. |
|----------|---|--------------|--|--|
| 1 | - | 1 | 28274029 | A-28274029 |
| 2 | - | 1 | 41921801 | A-41921801 |
| 3 | - | 1 | 41929000 | A-41929000 |
| 4 | - | 1 | 41939300 | A-41939300 |
| 5 | - | 1 | 41975300 | A-41975300 |
| 6 | - | 1 | 41978800 | A-41978800 |
| 7 | - | 1 | 41979600 | A-41979600 |
| 8 | - | 1 | 41979800 | A-41979800 |
| 9 | - | 1 | 41980500 | A-41980500 |
| 10 | - | 1 | 41981100 | A-41981100 |
| 11 | - | 1 | 41981200 | A-41981200 |
| 12 | - | 1 | 41986300 | A-41986300 |
| 13 | - | 1 | 41990001 | A-41990001 |
| 14 | - | 1 | 41990007 | A-41990007 |
| 15 | - | 1 | 41990007 | A-41990007 |
| 16 | - | 1 | 41990059 | A-41990059 |
| 17 | - | 1 | 41990064 | A-41990064 |
| 18 | - | 1 | 685121585 | A-685121585 |



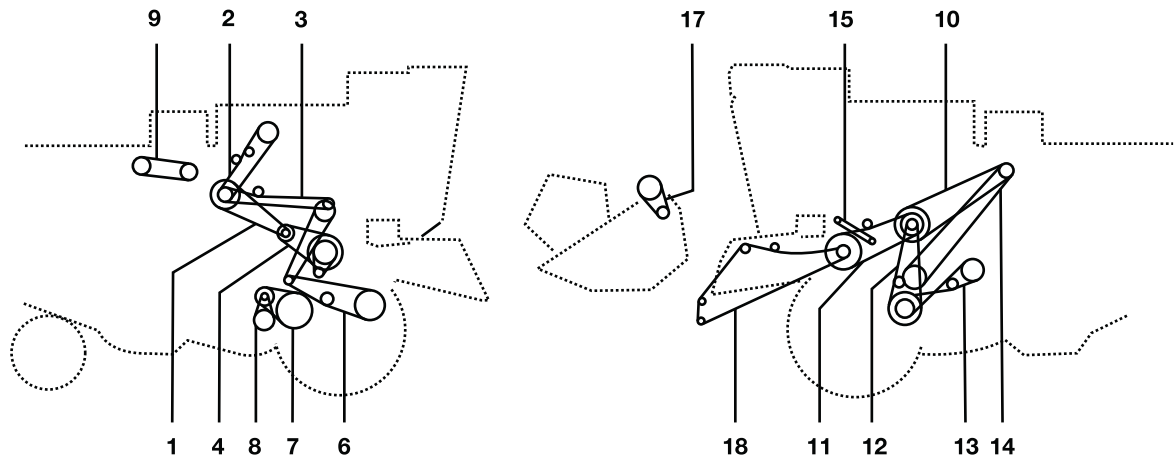

FORTSCHRITT E 514



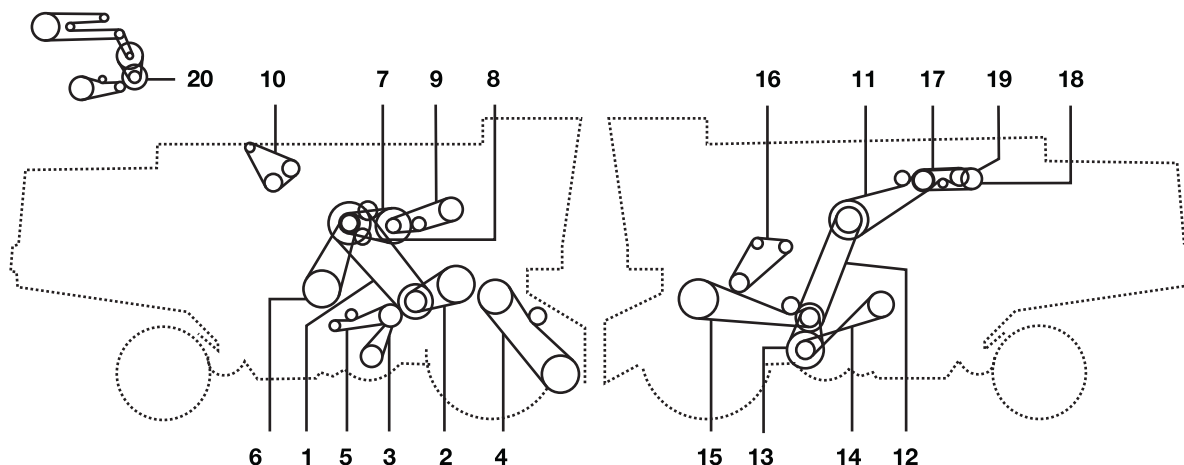

| Belt No. |  | No. of Belts | OEM  Part No. | PIX  Part No. |
|----------|---|--------------|--|--|
| 1 | - | 1 | 4254138824 | A-4254138824 |
| 2 | - | 1 | 4250129755 | A-4250129755 |
| 3 | - | 1 | 4250129747 | A-4250129747 |
| 4 | - | 1 | 4250121877 | A-4250121877 |
| 5 | - | 1 | 4250121882 | A-4250121882 |
| 6 | - | 1 | 4250121772 | A-4250121772 |
| 7 | - | 1 | 4254138857 | A-4254138857 |
| 8 | - | 1 | 4250121860 | A-4250121860 |
| 9 | - | 1 | 4254138865 | A-4254138865 |
| 10 | - | 1 | 4250121764 | A-4250121764 |
| 11 | - | 1 | 4260703926 | A-4260703926 |
| 12 | - | 1 | 4254138832 | A-4254138832 |
| 13 | - | 1 | 4254138840 | A-4254138840 |
| 14 | - | 1 | 4250129730 | A-4250129730 |
| 16 | - | 1 | 4250121780 | A-4250121780 |
| 17 | - | 1 | 4221668173 | A-4221668173 |

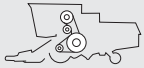
FORTSCHRITT E 516 - E 516 B - E 517



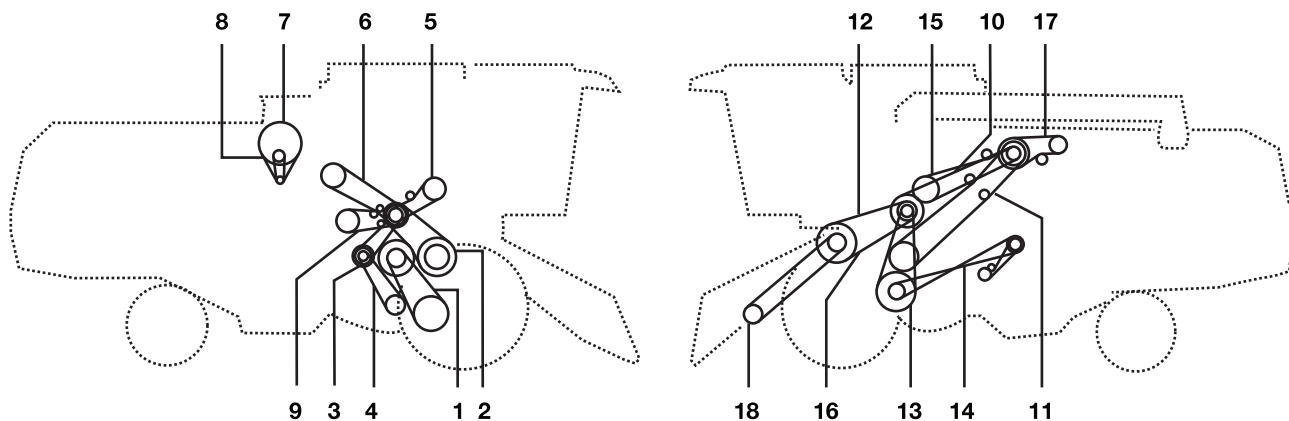

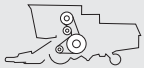
| Belt No. |  | No. of Belts | OEM  Part No. | PIX  Part No. |
|----------|---|--------------|--|--|
| 1 | - | 1 | 4240023362 | A-4240023362 |
| 2 | - | 1 | 4240023387 | A-4240023387 |
| 3 | - | 1 | 4240023354 | A-4240023354 |
| 4 | - | 1 | 4240023395 | A-4240023395 |
| 5 | - | 1 | 4240044287 | A-4240044287 |
| 6 | - | 1 | 4240044295 | A-4240044295 |
| 7 | - | 1 | 4240044301 | A-4240044301 |
| 8 | - | 2 | 4240044246 | A-4240044246 |
| 9 | - | 2 | 4240044270 | A-4240044270 |
| 10 | - | 1 | 9911861645 | A-9911861645 |
| 11 | - | 1 | 4240023370 | A-4240023370 |
| 12 | - | 2 | 4240044254 | A-4240044254 |
| 13 | - | 2 | 4240046545 | A-4240046545 |
| 14 | - | 1 | 4240040388 | A-4240040388 |
| 15 | - | 1 | 4240023395 | A-4240023395 |
| 16 | - | 1 | 4240044301 | A-4240044301 |
| 17 | - | 2 | 4240044262 | A-4240044262 |
| 18 | - | 2 | 4240044584 | A-4240044584 |
| 19 | - | 2 | 4240043405 | A-4240043405 |
| 20 | - | 1 | 4240043413 | A-4240043413 |



| Belt No. |  | No. of Belts | OEM  Part No. | PIX  Part No. |
|----------|---|--------------|--|--|
| 0 | - | 1 | 4260700007 | A-4260700007 |
| 0 | - | 1 | 9911861725 | A-9911861725 |
| 0 | - | 1 | 9911861758 | A-9911861758 |
| 1 | - | 1 | 4260699993 | A-4260699993 |
| 2 | - | 1 | 4250121877 | A-4250121877 |
| 3 | - | 1 | 4240044301 | A-4240044301 |
| 4 | - | 1 | 4240023354 | A-4240023354 |
| 5 | - | 1 | 4260700015 | A-4260700015 |
| 6 | - | 1 | 4260700023 | A-4260700023 |
| 7 | - | 1 | 4260703838 | A-4260703838 |
| 8 | - | 1 | 4260703846 | A-4260703846 |
| 9 | - | 1 | 60143505 | A-60143505 |
| 10 | - | 1 | 4260699985 | A-4260699985 |
| 11 | - | 1 | 4260699960 | A-4260699960 |
| 12 | - | 1 | 4260703926 | A-4260703926 |
| 13 | - | 1 | 4260700031 | A-4260700031 |
| 14 | - | 1 | 60143490 | A-60143490 |
| 15 | - | 1 | 4260699977 | A-4260699977 |
| 16 | - | 1 | 4260703942 | A-4260703942 |
| 17 | - | 1 | 4270727737 | A-4270727737 |
| 18 | - | 1 | 4260715183 | A-4260715183 |

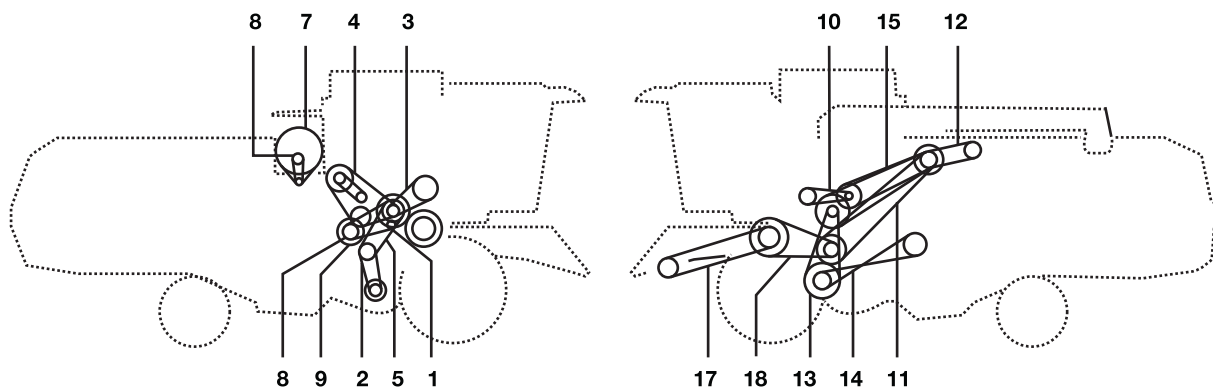

FORTSCHRITT E 527



| Belt No. | | No. of Belts | OEM  Part No. | PIX  Part No. |
|----------|---|--------------|--|--|
| 1 | - | 1 | 60183586 | A-60183586 |
| 2 | - | 1 | 4240023354 | A-4240023354 |
| 3 | - | 1 | 4260700015 | A-4260700015 |
| 4 | - | 1 | 4270722517 | A-4270722517 |
| 5 | - | 1 | 61011077 | A-61011077 |
| 6 | - | 1 | 61017105 | A-61017105 |
| 8 | - | 1 | 61029584 | A-61029584 |
| 9 | - | 1 | 61009402 | A-61009402 |
| 10 | - | 1 | 61020978 | A-61020978 |
| 11 | - | 1 | 60168160 | A-60168160 |
| 12 | - | 1 | 4270727737 | A-4270727737 |
| 13 | - | 1 | 4270722252 | A-4270722252 |
| 14 | - | 1 | 61009082 | A-61009082 |
| 15 | - | 1 | 61020986 | A-61020986 |
| 16 | - | 1 | 61009074 | A-61009074 |
| 17 | - | 1 | 61004680 | A-61004680 |

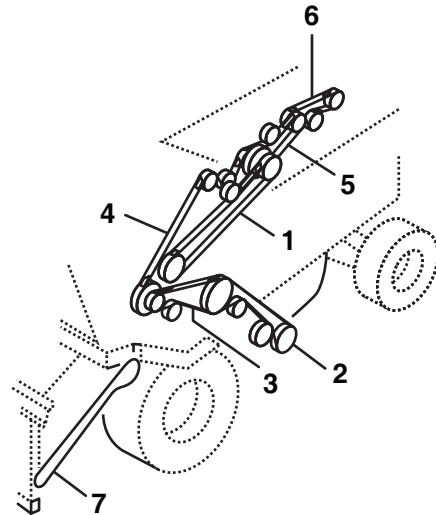
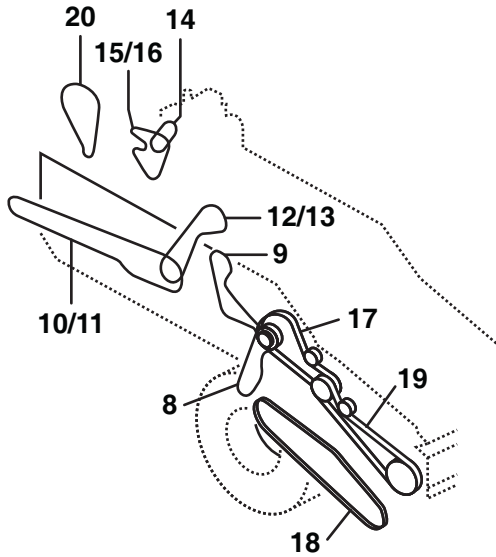

GLENER A65



| Belt No. |  | No. of Belts | OEM  Part No. | PIX  Part No. |
|----------|---|--------------|--|--|
| 1 | Unloader Drive | 1 | 101102M1 | A-101102M1 |
| 2 | Grain Elevator Drive | 1 | 71403685 | A-71403685 |
| 3 | Shaker Shoe Pitman Drive | 1 | 71390199 | A-71390199 |
| 4 | Beater Drive | 1 | 71386352 | A-71386352 |
| 5 | Main Countershaft Drive | 1 | 71390188 | A-71390188 |
| 6 | Tandem Pump Drive | 1 | 71418984 | A-71418984 |
| 7 | Header Countershaft To Pivot Shaft | 1 | 71398388 | A-71398388 |
| 8 | Variable Speed Fandrive | 1 | 71394352 | A-71394352 |
| 9 | Return Elevator Drive | 1 | 71385801 | A-71385801 |
| 10 | Spreader Drive | 1 | 1680230W1 | A-1680230W1 |
| 11 | Chopper Secondary Drive | 1 | 71406339 | A-71406339 |
| 12 | Spreader Jackshaft Drive | 1 | 227455M1 | A-227455M1 |
| 13 | Chopper Primary Drive | 1 | 71406361 | A-71406361 |
| 14 | A/c Compressor Drive | 1 | 71148120 | A-71148120 |
| 15 | Fan / Alternator (prior To Eng. Sn T11858) | 1 | V685121585 | A-V685121585 |
| 16 | Fan / Alternator (eff Eng. Sn T11858) | 1 | V685121530 | A-V685121530 |
| 17 | Beater-to-feeder House Jackshaft | 1 | 71398384 | A-71398384 |
| 18 | Variable Speed-to-header Countershaft | 1 | 71399505 | A-71399505 |
| 19 | Jackshaft-to-header Countershaft | 1 | 71399519 | A-71399519 |
| 20 | Rotary Screen | 1 | 71396754 | A-71396754 |

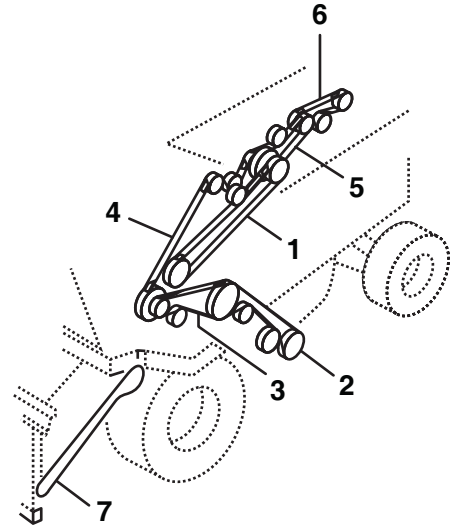
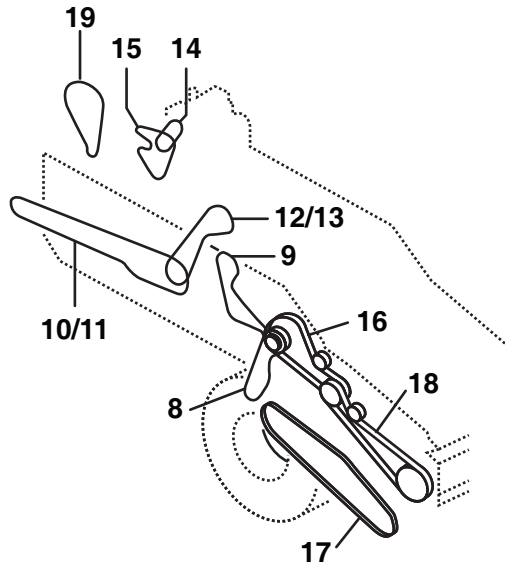

GLENER A66



| Belt No. |  | No. of Belts | OEM  Part No. | PIX  Part No. |
|----------|---|--------------|--|--|
| 1 | Bin Unloader Drive | 1 | 71410767 | A-71410767 |
| 2 | Grain Drive | 1 | 71410765 | A-71410765 |
| 3 | Shaker Shoe Pitman Drive | 1 | 71390199 | A-71390199 |
| 4 | Beater Drive | 1 | 71388216 | A-71388216 |
| 5 | Main Countershaft Drive | 1 | 71390188 | A-71390188 |
| 6 | Tandem Pump Drive | 1 | 71418984 | A-71418984 |
| 7 | Feeder Pivot Shaft Drive | 1 | 71427255 | A-71427255 |
| 8 | Variable Speed Fan Drive | 1 | 71394352 | A-71394352 |
| 9 | Return Elevator Drive | 1 | 71385801 | A-71385801 |
| 10 | Chopper Secondary Drive | 1 | 71406339 | A-71406339 |
| 11 | Spreader Drive (secondary) | 1 | 1680230W1 | A-1680230W1 |
| 12 | Spreader Drive (primary) | 1 | 71414420 | A-71414420 |
| 13 | Chopper Drive (primary) | 1 | 71406338 | A-71406338 |
| 14 | A/c Compressor Drive | 1 | 71148120 | A-71148120 |
| 15 | Fan/alternator Drive | 1 | V685121530 | A-V685121530 |
| 16 | Beater-to-feeder House Jackshaft | 1 | 71398384 | A-71398384 |
| 17 | Variable Speed-to-header Countershaft | 1 | 71399505 | A-71399505 |
| 18 | Jackshaft-to-header Countershaft | 1 | 71399519 | A-71399519 |
| 19 | Rotary Screen Drive | 1 | 71396754 | A-71396754 |

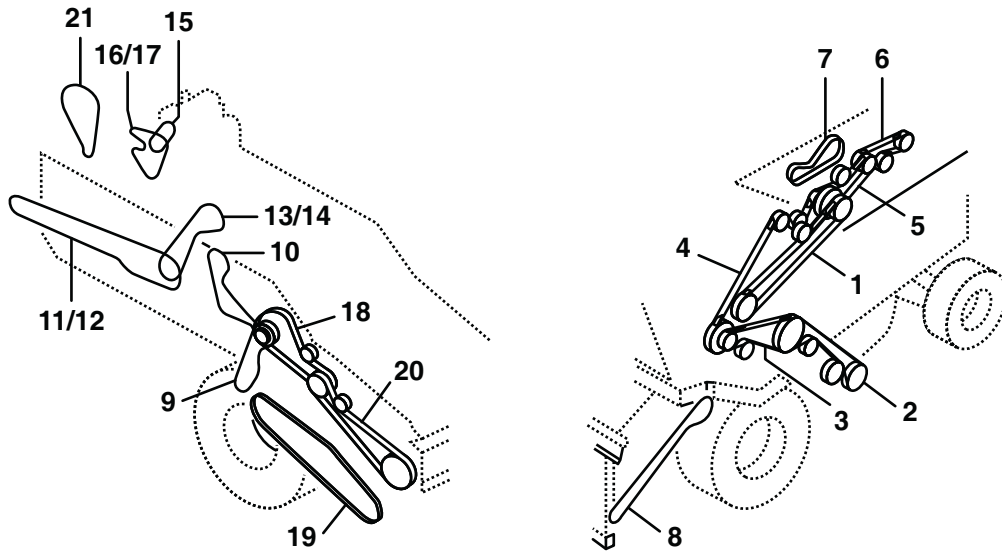

GLENER A75



| Belt No. |  | No. of Belts | OEM  Part No. | PIX  Part No. |
|----------|---|--------------|--|--|
| 1 | Unloader Drive | 1 | 101102M1 | A-101102M1 |
| 2 | Grain Elevator Drive | 1 | 71403685 | A-71403685 |
| 3 | Shaker Shoe Pitman Drive | 1 | 71390199 | A-71390199 |
| 4 | Beater Drive | 1 | 71388216 | A-71388216 |
| 5 | Main Countershaft Drive | 1 | 71418976 | A-71418976 |
| 6 | Rotor Pump Drive | 1 | 71390188 | A-71390188 |
| 7 | Propel Pump Drive | 1 | 71418978 | A-71418978 |
| 8 | Header Countershaft To Pivot Shaft | 1 | 71398388 | A-71398388 |
| 9 | Variable Speed Fandrive | 1 | 71394352 | A-71394352 |
| 10 | Return Elevator Drive | 1 | 71385801 | A-71385801 |
| 11 | Chopper Drive (secondary) | 1 | 71406339 | A-71406339 |
| 13 | Spreader Jackshaft Drive | 1 | 71414420 | A-71414420 |
| 14 | Chopper Drive (primary) 136.5" | 1 | 71406361 | A-71406361 |
| 15 | A/c Compressor Drive | 1 | 71148120 | A-71148120 |
| 16 | Fan / Alternator Drive (prior To Eng Sn T11858) | 1 | V685121585 | A-V685121585 |
| 17 | Fan/alternator Drive (eff. Sn T11858) | 1 | V685121530 | A-V685121530 |
| 18 | Beater-to-feeder House Jackshaft | 1 | 71398384 | A-71398384 |
| 19 | Variable Speed-to-header Countershaft | 1 | 71399505 | A-71399505 |
| 20 | Jackshaft-to-header Countershaft | 1 | 71399519 | A-71399519 |
| 21 | Rotary Screen Drive | 1 | 71396754 | A-71396754 |

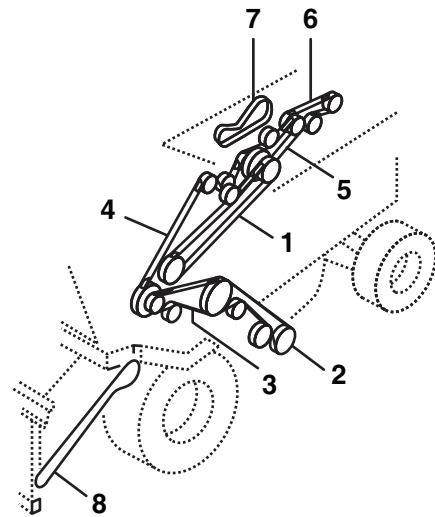
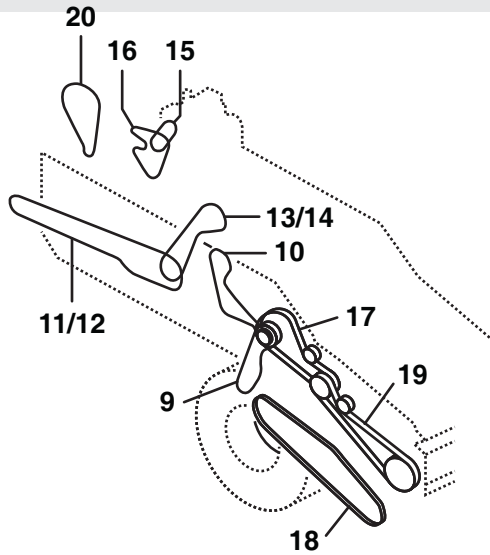

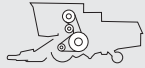
GLENER A76



| Belt No. |  | No. of Belts | OEM  Part No. | PIX  Part No. |
|----------|---|--------------|--|--|
| 1 | Unloader Drive | 1 | 71410767 | A-71410767 |
| 2 | Grain Elevator Drive | 1 | 71410765 | A-71410765 |
| 3 | Shaker Shoe Pitman Drive | 1 | 71390199 | A-71390199 |
| 4 | Beater Drive | 1 | 71388216 | A-71388216 |
| 5 | Main Countershaft Drive | 1 | 71390188 | A-71390188 |
| 6 | Rotor Pump Drive | 1 | 71418976 | A-71418976 |
| 7 | Propel Pump Drive | 1 | 71418978 | A-71418978 |
| 8 | Feeder Pivot Shaft Drive | 1 | 71427255 | A-71427255 |
| 9 | Variable Speed Fan Drive | 1 | 71394352 | A-71394352 |
| 10 | Return Elevator Drive | 1 | 71385801 | A-71385801 |
| 11 | Chopper Drive (secondary) | 1 | 71406339 | A-71406339 |
| 12 | Spreader Drive (secondary) | 1 | 1680230W1 | A-1680230W1 |
| 13 | Spreader Drive (primary) | 1 | 71414420 | A-71414420 |
| 14 | Chopper Drive (primary) | 1 | 71406338 | A-71406338 |
| 15 | A/c Compressor Drive | 1 | 71148120 | A-71148120 |
| 17 | Beater-to-feeder House Jackshaft | 1 | 71398384 | A-71398384 |
| 18 | Variable Speed-to-header Countershaft | 1 | 71399505 | A-71399505 |
| 19 | Jackshaft-to-header Countershaft | 1 | 71399519 | A-71399519 |
| 20 | Rotary Screen Drive | 1 | 71396754 | A-71396754 |

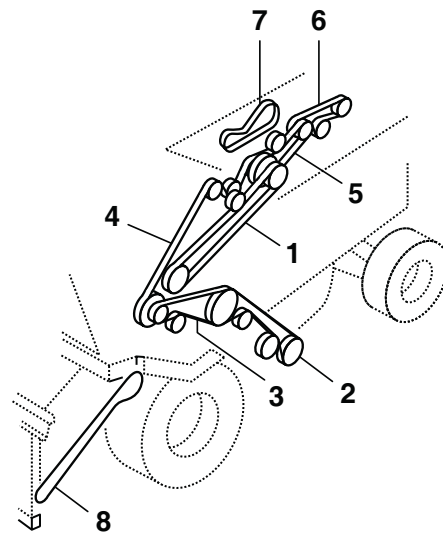
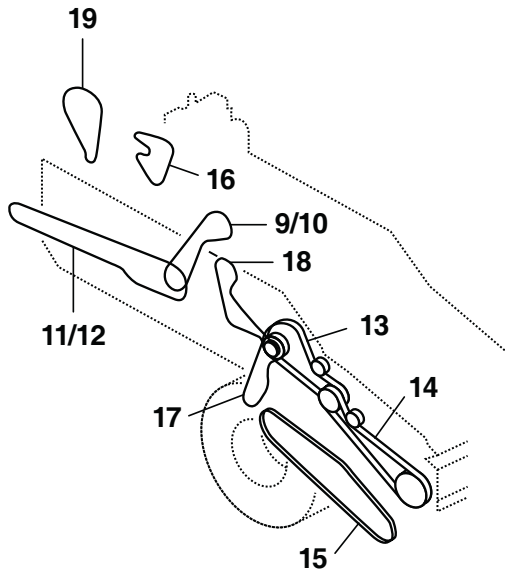

GLENER A85

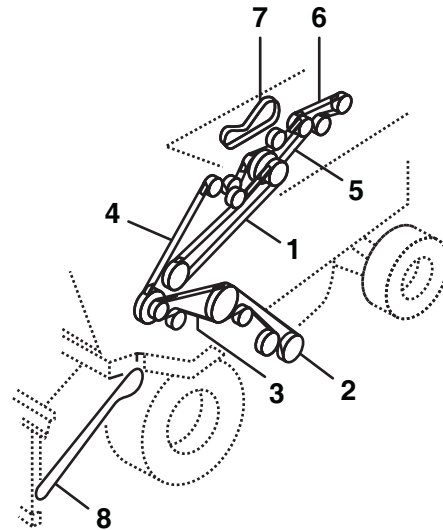
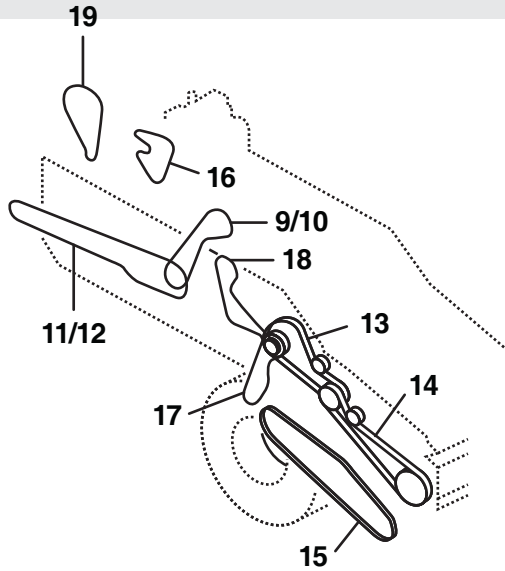

| Belt No. |  | No. of Belts | OEM  Part No. | PIX  Part No. |
|----------|---|--------------|--|--|
| 1 | | 1 | 71410767 | A-71410767 |
| 2 | | 1 | 71403685 | A-71403685 |
| 3 | | 1 | 71390199 | A-71390199 |
| 4 | | 1 | 71388216 | A-71388216 |
| 5 | | 1 | 71403721 | A-71403721 |
| 6 | | 1 | 71406285 | A-71406285 |
| 7 | | 1 | 71406286 | A-71406286 |
| 8 | | 1 | 71427255 | A-71427255 |
| 9 | | 1 | 71414420 | A-71414420 |
| 10 | | 1 | 71406338 | A-71406338 |
| 12 | | 1 | 71406339 | A-71406339 |
| 13 | | 1 | 71398384 | A-71398384 |
| 14 | | 1 | 71399519 | A-71399519 |
| 17 | | 1 | 71400662 | A-71400662 |
| 18 | | 1 | 71385801 | A-71385801 |
| 19 | | 1 | 71396754 | A-71396754 |

GLENER A85-AXIAL FLOW

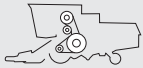

| Belt No. |  | No. of Belts | OEM  Part No. | PIX  Part No. |
|----------|---|--------------|--|--|
| 1 | ROTARY SCREEN | 1 | 71396754 | A-71396754 |
| 2 | CLEAN GRAIN ELEVATOR DRIVE | 1 | 71403685 | A-71403685 |
| 3 | MAIN COUNTERSHAFT | 1 | 71403721 | A-71403721 |
| 4 | BEATER-TO-JACKSHAFT | 1 | 71398384 | A-71398384 |
| 6 | FIXED SPEED COUNTERSHAFT DRIVE | 1 | 71399519 | A-71399519 |
| 7 | FRONT BEATER | 1 | 71388216 | A-71388216 |
| 8 | LH PIVOT DRIVE | 1 | 71427255 | A-71427255 |
| 9 | PITMAN DRIVE | 1 | 71390199 | A-71390199 |
| 10 | PRIMARY CHOPPER DRIVE | 1 | 71406338 | A-71406338 |
| 11 | PRIMARY CHOPPER / SPREADERDRIVE | 1 | 71414420 | A-71414420 |
| 12 | PROPEL PUMP DRIVE | 1 | 71406286 | A-71406286 |
| 13 | RETURN ELEVATOR DRIVE | 1 | 71385801 | A-71385801 |
| 14 | ROTOR PUMPS | 1 | 71406285 | A-71406285 |
| 15 | SECONDARY CHOPPER DRIVE | 1 | 71406339 | A-71406339 |
| 16 | SECONDARY SPREADER DRIVE | 1 | 1680230W1 | A-1680230W1 |
| 17 | VARIABLE SPEED HEADER DRIVE | 1 | 71423444 | A-71423444 |
| 18 | BIN UNLOADER | 1 | 71410767 | A-71410767 |

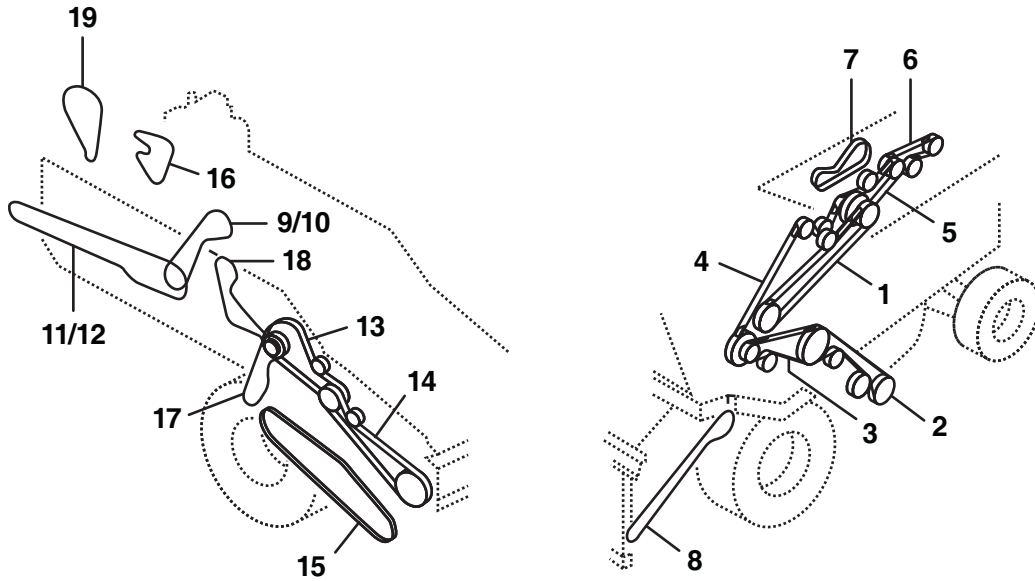

GLENER A86

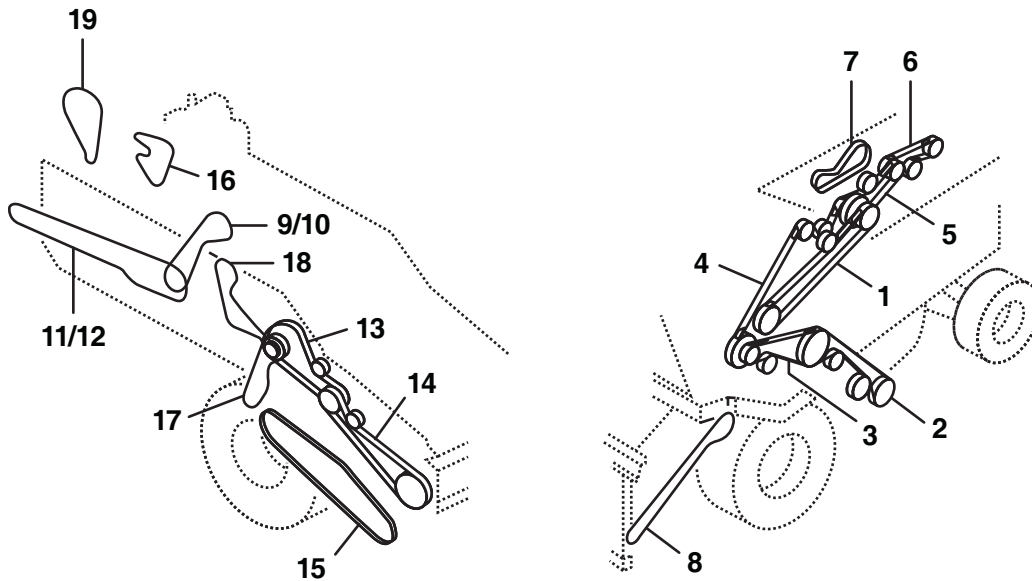

| Belt No. | | No. of Belts | OEM Part No. | PIX Part No. |
|----------|--|--------------|---------------|---------------|
| 1 | | 1 | 71410767 | A-71410767 |
| 2 | | 1 | 71410765 | A-71410765 |
| 3 | | 1 | 71390199 | A-71390199 |
| 4 | | 1 | 71388216 | A-71388216 |
| 5 | | 1 | 71403721 | A-71403721 |
| 6 | | 1 | 71406285 | A-71406285 |
| 7 | | 1 | 71406286 | A-71406286 |
| 8 | | 1 | 71427255 | A-71427255 |
| 9 | | 1 | 71414420 | A-71414420 |
| 10 | | 1 | 71406338 | A-71406338 |
| 11 | | 1 | 1680230W1 | A-1680230W1 |
| 12 | | 1 | 71406339 | A-71406339 |
| 13 | | 1 | 71398384 | A-71398384 |
| 14 | | 1 | 71399519 | A-71399519 |
| 15 | | 1 | 71399505 | A-71399505 |
| 17 | | 1 | 71400662 | A-71400662 |
| 18 | | 1 | 71385801 | A-71385801 |
| 19 | | 1 | 71396754 | A-71396754 |

GLENER A86-AXIAL FLOW



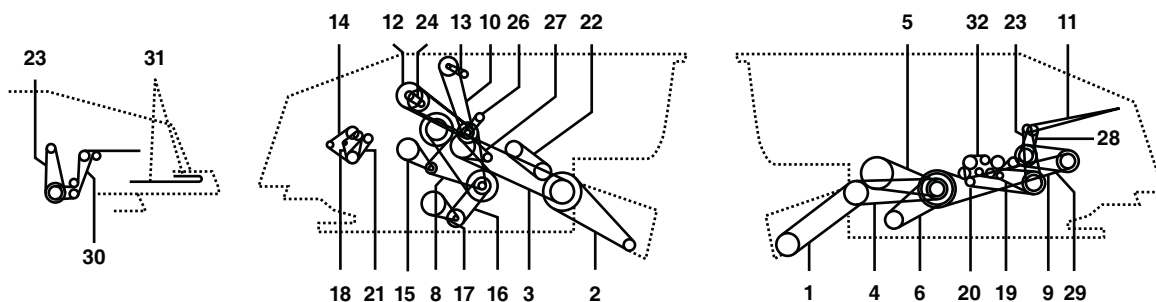

| Belt No. |  | No. of Belts | OEM  Part No. | PIX  Part No. |
|----------|---|--------------|--|--|
| 1 | Bin Unloader Drive | 1 | 71410767 | A-71410767 |
| 2 | Grain Elevator Drive | 1 | 71410765 | A-71410765 |
| 3 | Shaker Shoe Pitman Drive | 1 | 71390199 | A-71390199 |
| 4 | Beater Drive | 1 | 71388216 | A-71388216 |
| 5 | Main Countershaft Drive | 1 | 71403721 | A-71403721 |
| 6 | Rotor Pumps Drive | 1 | 71406285 | A-71406285 |
| 7 | Propel Pump Drive | 1 | 71406286 | A-71406286 |
| 8 | Feeder Pivot Shaft Drive | 1 | 71427255 | A-71427255 |
| 9 | Spreader Drive (primary) | 1 | 71414420 | A-71414420 |
| 10 | Chopper Drive (primary) | 1 | 71406338 | A-71406338 |
| 11 | Spreader Drive (secondary) | 1 | 1680230W1 | A-1680230W1 |
| 12 | Chopper Drive (secondary) | 1 | 71406339 | A-71406339 |
| 13 | Beater-to-feeder House Jackshaft | 1 | 71398384 | A-71398384 |
| 14 | Jackshaft-to-header Countershaft | 1 | 71399519 | A-71399519 |
| 15 | Variable Speed-to-header Countershaft | 1 | 71399505 | A-71399505 |
| 17 | Variable Speed Cleaning Fan Drive | 1 | 71400662 | A-71400662 |
| 18 | Return Elevator Drive | 1 | 71385801 | A-71385801 |
| 19 | Rotary Screen Drive | 1 | 71396754 | A-71396754 |





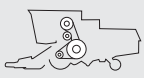

| Belt No. |  | No. of Belts | OEM  Part No. | PIX  Part No. |
|----------|--|--------------|--|--|
| 1 | Constantspeedheaderdrive(N5- PRIORTO SN4501; N6-PRIOR TOSN5101; N7- PRIOR TOSN2501) | 2 | 71301859V | A-71301859V |
| 1 | Constant Speed Headerdrive (N5- EFF.SN4501; N6- EFF.SN5101;N7 - EFF.SN2501;R5; R6;R7) | 1 | 71320449V | A-71320449V |
| 1 | Variablespeedheaderdrive(N5 -PRIOR TOSN 4501; N6- PRIOR TOSN5101;N7- PRIORTO SN2501) | 1 | 71197876V | A-71197876V |
| 1 | Variablespeed Header Drive(N5- EFF.SN 4501; N6- EFF.SN 5101;N7- EFF.SN 2501;R5;R6; R7) | 1 | 71316268V | A-71316268V |
| 2 | Pivot Shaft Drive (N5 - PRIOR TO SN4501; N6 - PRIOR TO SN5101; N7 - PRIOR TOSN 2501) | 1 | 71309150V | A-71309150V |
| 2 | Pivot Shaft Drive (N5 - EFF. SN 4501; N6 - EFF. SN 5101; N7 - EFF. SN 2501; R5; R6; R7) | 2 | 71316263V | A-71316263V |
| 3 | Rear Feed Conveyor Drive (N5; N6; N7; R5; R6; R7) | 1 | 71326830V | A-71326830V |
| 4 | Pivot Drive, Left Hand (N5; N6; N7; R5; R6; R7) | 1 | 71310382V | A-71310382V |
| 5 | Unloader Drive, left Hand (N5; N6; N7; R5; R6; R7) | 1 | 71310380V | A-71310380V |
| 6 | Hydro Drive (N5; N6; R5; R6) | 1 | 71197999V | A-71197999V |
| 6 | Hydro Drive (N7 - EFF. SN 4800; R7) | 1 | 71342143V | A-71342143V |
| 7 | Cylinder Drive (N5 - EFF. SN 6101; N6 - EFF. SN 7301; N7; R5; R6; R7) | 1 | 71364789V | A-71364789V |
| 8 | Overfeedauger Drive(N5 - PRIOR TO SN 4501; N6 - PRIOR TO SN 5101; N7 - PRIOR TO SN 2510) | 2 | 71309685V | A-71309685V |
| 8 | Overfeed Auger Drive (N5 - EFF.SN 4501;N6 - EFF. SN5101; N7 - EFF. SN2501; R5; R6;R7) | 2 | 71325150V | A-71325150V |
| 9 | Main Drive (N7; R7) | 1 | 71307200V | A-71307200V |
| 9 | Main Drive (N6 - Prior To SN 5101) | 1 | 71314273V | A-71314273V |
| 9 | Main Drive (N5; N6 - EFF. SN 5101; R5; R6) | 1 | 71336997V | A-71336997V |
| 10 | Clean Grain Elevator Drive | 1 | 71325847V | A-71325847V |
| 11 | Spreader Drive, With Chopper | 1 | 71326253V | A-71326253V |
| 11 | Spreader Drive, Without Chopper (N5; N6; N7; R7) | 1 | 71334919V | A-71334919V |
| 11 | Spreader Drive, Without Chopper (R5; R6) | 1 | 71347560V | A-71347560V |
| 12 | Cage Sweep Drive (N5 - EFF. SN 1301; N6 - EFF. SN 1501; N7; R5; R6; R7) | 1 | 71312339V | A-71312339V |
| 14 | Alternator Drive (N7; R7) | 1 | 71175687 | A-71175687 |
| 14 | Alternator Drive, Heavy- Duty (N5 - PRIOR TOSN 4501; N6 - PRIOR TO SN 5101) | 1 | 71306200V | A-71306200V |

GLENER N5 - N6 - N7- R5 - R6 - R7

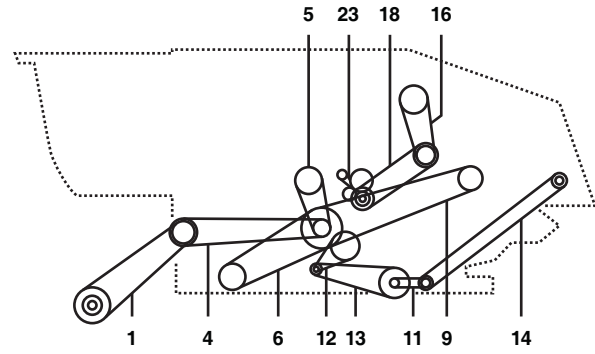
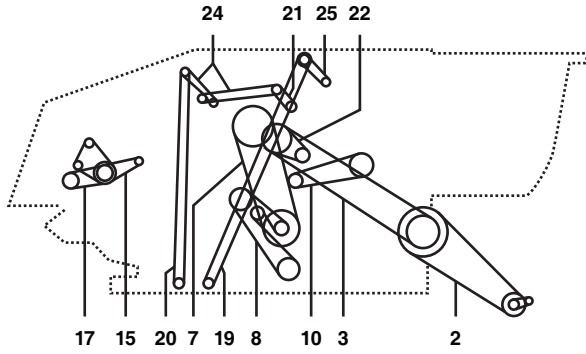
| Belt No. |  | No. of Belts | OEM  Part No. | PIX  Part No. |
|----------|---|--------------|--|--|
| 14 | Alternator Drive, 110 Amp (n5 - Eff. Sn 4501- 6101; N6 - Eff. Sn 5105- 7301) | 2 | 71186454V | A-71186454V |
| 14 | Alternator Drive, 105 Amp (n5 - Eff. Sn 6101; N6 - Eff. Sn 7301; R5; R6) | 1 | 71336137V | A-71336137V |
| 15 | Tailings Drive (n5; N6; N7; R5; R6; R7) | 1 | 71346200 | A-71346200 |
| 16 | Fan Drive (n5 - Prior To Sn 6101; N6 - Priorto Sn 7301; N7 - Prior To Sn 4501) | 1 | 71340653 | A-71340653 |
| 16 | Fan Drive (n5 - Eff. Sn 6101; N6 - Eff. Sn 7301; N7 - Eff. Sn 4501; R5; R6; R7) | 1 | 71339886V | A-71339886V |
| 17 | Shoe Drive | 2 | 71336307V | A-71336307V |
| 18 | Fan Drive, Set(n5; N6; R5; R6) | 1 | 71302482V | A-71302482V |
| 18 | Fan Drive, Set(n7; R7) | 2 | 74321275V | A-74321275V |
| 19 | Jackshaft Drive | 1 | 71313804 | A-71313804 |
| 20 | Cylinder Auger Drive | 1 | 71319657V | A-71319657V |
| 21 | Compressor Drive (n5; N6; R5; R6) | 1 | 71193420 | A-71193420 |
| 21 | Compressor Drive (n7; R7) | 1 | 71315910V | A-71315910V |
| 22 | Unloaderdrive, Righthand(n5 - Priortosn 4501; n6- Priorto Sn5101; N7-priorto Sn1701) | 1 | 71177795 | A-71177795 |
| 23 | Impeller Drive (n5 - Prior To Sn 6101; N6 - Prior Tosn 7301; N7 - Prior To Sn 4501) | 1 | 71313804 | A-71313804 |
| 23 | Impeller Drive,with Singlespreader (n5- Eff.sn 4501; N6- Eff. Sn 5101;n7 - Eff.sn 1262) | - | 71322418V | A-71322418V |
| 23 | Impeller Drive,with Dualspreader (n5 - Eff. Sn 6101; N6 - Eff. Sn 7301; N7; R5; R6; R7) | 2 | 71358134V | A-71358134V |
| 25 | Tailings Return Drive | 1 | 71337000V | A-71337000V |
| 28 | Straw Chopper Drive | 1 | 71358486V | A-71358486V |
| 29 | Straw Chopper / Jackshaft Drive | 1 | 71344935V | A-71344935V |
| 30 | Spreader Jackshaft Drive (n5 - Eff. Sn 6101; N6 - Eff. Sn 7301; N7; R5; R6; R7) | 1 | 71347560V | A-71347560V |
| 31 | Spreader Drive, Withdualspreader (n5 - Eff. Sn6101; N6 - Eff. Sn7301; N7; R5; R6; R7) | 2 | 71347561V | A-71347561V |

GLENER R40 - R50



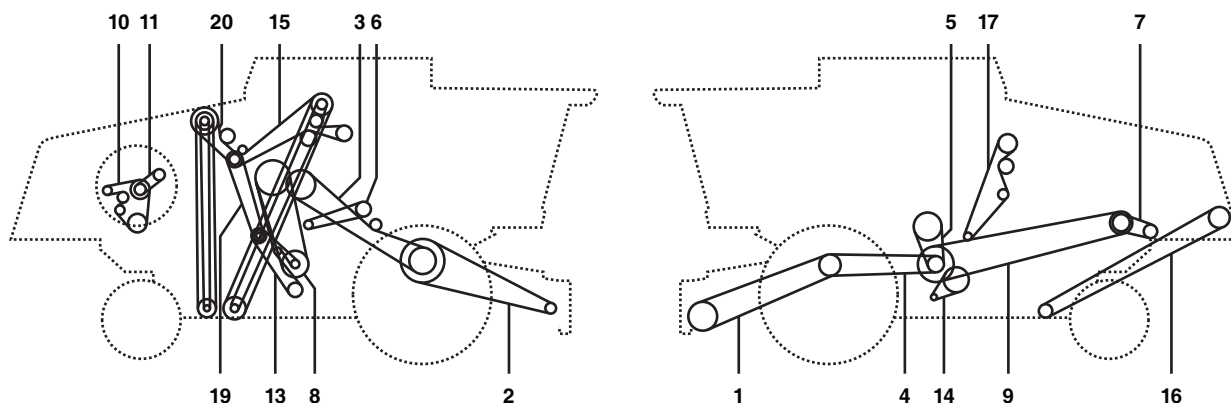

| Belt No. |  | No. of Belts | OEM  Part No. | PIX  Part No. |
|----------|---|--------------|--|--|
| 1 | Variable Speed Header Drive | 1 | 71316268 | A-71316268 |
| 1 | Constant Speed Header Drive | 1 | 71320449 | A-71320449 |
| 2 | Pivot Shaft Drive, Right Hand (R40 - PRIORTO SN 2001; R50 - PRIOR TO SN 3501) | 2 | 71316263V | A-71316263V |
| 2 | Pivot Shaft Drive, Right Hand (R40 - EFF. SN 2001; R50 - EFF. SN 3501) | 1 | 71354198V | A-71354198V |
| 3 | Rear Feed Conveyor Drive | 1 | 71335475 | A-71335475 |
| 4 | Pivot Jackshaft Drive | 1 | 71355232 | A-71355232 |
| 5 | Bin Unloader Drive, Left Hand | 1 | 71398366 | A-71398366 |
| 6 | Hydro Drive | 1 | 71364912 | A-71364912 |
| 7 | Variable Speed Cylinder Drive | 1 | 71335788 | A-71335788 |
| 8 | Separator Drive | 1 | 71358255 | A-71358255 |
| 9 | Main Drive | 1 | 71351260V | A-71351260V |
| 14 | Straw Spreader Drive | 1 | 71355170 | A-71355170 |
| 15 | Alternator Drive | 1 | 71352139 | A-71352139 |
| 16 | Chopper / Impeller Drive | 2 | 71336199V | A-71336199V |
| 17 | Compressor Drive | 1 | 71352729 | A-71352729 |
| 18 | Jackshaft Drive | 1 | 71333673V | A-71333673V |

GLENER R42 - R52 - R55



| Belt No. |  | No. of Belts | OEM  Part No. | PIX  Part No. |
|----------|--|--------------|--|--|
| 1 | Variable Speed Header Drive | 1 | 71390886 | A-71390886 |
| 1 | Constant Speed Header Drive | 1 | 71364514 | A-71364514 |
| 2 | Right Hand Pivot Shaft Drive (R42 - Prior To Sn 43001; R52 - Prior To Sn 53001) | 1 | 71364155 | A-71364155 |
| 2 | Right Hand Pivotshaft Drive (R42 - Prior To Sn 43001; R52 - Prior To Sn 53001; R55) | 1 | 71374306 | A-71374306 |
| 3 | Rear Feed Conveyor Drive | 1 | 71335475 | A-71335475 |
| 4 | Pivot Jackshaft Drive | 1 | 71355232 | A-71355232 |
| 5 | Bin Unloader Drive Left Hand | 1 | 71398366 | A-71398366 |
| 7 | Hydro Drive (R42 - Prior To Sn 46001; R52 - Prior To Sn 56001) | 1 | 71364912 | A-71364912 |
| 7 | Hydro Drive (R42 - Eff. Sn 46001; R52 - Eff. To Sn 56001; R55) | 1 | 71374277 | A-71374277 |
| 8 | Variable Speed Cylinder Drive | 1 | 71335788 | A-71335788 |
| 9 | Main Drive, Air Cooled (R42 - Prior To Sn 48001; R52 - Prior To Sn 58000) | 1 | 71351260 | A-71351260 |
| 9 | Main Drive, Liquid Cooled (R42 - Prior To Sn 43001; R52 - Prior To Sn 53001; R55) | 1 | 71366207 | A-71366207 |
| 10 | Alternator, Air Cooled (R42 - Prior To Sn 48001; R52 - Prior To Sn 58000) | 1 | 71352139 | A-71352139 |
| 10 | Alternator, Liquid Cooled (R42 - Eff. Sn 48001; R52 - Eff. Sn 58000) | 1 | 71352142 | A-71352142 |
| 10 | A/c Compressor Drive (R42 - Eff. Sn 48001; R52 - Eff. Sn 58001; R55) | 1 | 71369747 | A-71369747 |
| 11 | Compressor Drive (R42 - Prior To Sn 48001; R52 - Prior To Sn 58000) | 1 | 71352729 | A-71352729 |
| 11 | Compressor Drive, liquid Cooled (R42 - Eff. Sn 43001 - 48001; R52 - Eff. Sn 53001 - 58000) | 1 | 71367191 | A-71367191 |
| 13 | Separator Drive | 1 | 71358255 | A-71358255 |
| 14 | Shoe Drive (R42 - Eff. Sn 43001 - 46001; R52 - Eff. Sn 53001 - 56001) | 1 | 71364077 | A-71364077 |
| 14 | Shoe Drive (R42 - Eff. Sn 46001; R52 - Eff. To Sn 56001; R55) | 1 | 71374305 | A-71374305 |
| 15 | Clean Grain Elevator Drive (R42 - Eff. Sn 43001; R52 - Eff. Sn 53001; R55) | 1 | 71368809 | A-71368809 |
| 16 | Straw Spreader Drive | 1 | 71355170 | A-71355170 |

GLEANER R42 - R52 - R55

| Belt No. |  | No. of Belts | OEM  Part No. | PIX  Part No. |
|----------|--|--------------|--|--|
| 17 | Chopper / Impeller Drive | 1 | 71386695 | A-71386695 |
| 17 | Fine Cut Chopper Drive (R55) | 1 | 71381955 | A-71381955 |
| 19 | Jackshaft Drive Right Hand (R42 - Eff. Sn 43001; R52 - Eff. Sn 53001; R55) | 1 | 71367469 | A-71367469 |
| 20 | Tailings Drive (R42 - Eff. Sn 48001; R52 - Eff. Sn 58001; R55) | 1 | 71367459 | A-71367459 |
| 20 | Tailings Drive, With Tailings Return (R42 - Eff. Sn 48001; R52 - Eff. Sn 58001; R55) | 1 | 71367460 | A-71367460 |



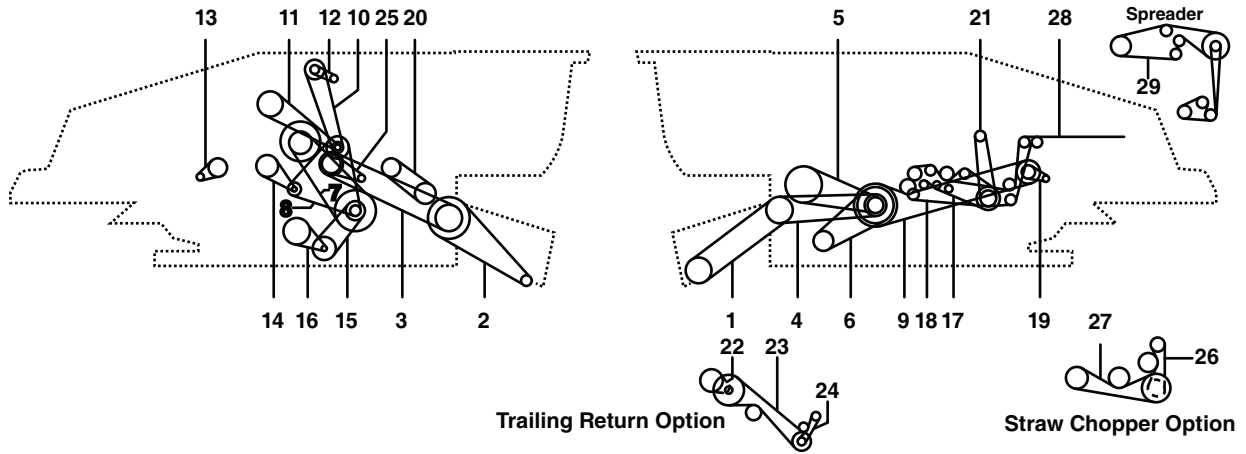

GLENER R60 - R70



| Belt No. |  | No. of Belts | OEM  Part No. | PIX  Part No. |
|----------|---|--------------|--|--|
| 1 | Variable Speed Header Drive | 1 | 71316268 | A-71316268 |
| 1 | Constant Speed Header Drive | 1 | 71320449V | A-71320449V |
| 2 | Pivot Shaft Drive (R60 - PRIOR TO SN 16501; R70 - PRIOR TO SN 12501) | 2 | 71316263V | A-71316263V |
| 2 | Pivot Shaft Drive (R60 - EFF. SN 16501; R70 - EFF. SN12501) | 1 | 71354198V | A-71354198V |
| 3 | Rear Feed Conveyor Drive (R60 - PRIOR TO SN 16501; R70 - PRIOR TO SN 12501) | 1 | 71326830V | A-71326830V |
| 3 | Rear Feed Conveyor Drive (R60 - EFF. SN 16501; R70 - EFF. SN 12501) | 1 | 71345800V | A-71345800V |
| 4 | Pivot Drive, Left Hand | 1 | 71310382V | A-71310382V |
| 5 | Unloader Drive, left Hand (R60 - PRIOR TO SN 15801; R70 - PRIOR TO SN 11801) | 1 | 71310380V | A-71310380V |
| 5 | Unloader Drive, power Engage (R60 - EFF. SN 15801; R70 - EFF. SN 11801) | 1 | 71356409V | A-71356409V |
| 6 | Hydro Drive (R60) | 1 | 71197999V | A-71197999V |
| 6 | Hydro Drive (R70) | 1 | 71342143V | A-71342143V |
| 7 | Cylinder Drive | 1 | 71364789V | A-71364789V |
| 8 | Separator Drive | 2 | 71325150V | A-71325150V |
| 9 | Main Drive (R60) | 1 | 71348999V | A-71348999V |
| 9 | Main Drive (R70) | 1 | 71348989V | A-71348989V |
| 10 | Clean Grain Elevator Drive | 1 | 71325847V | A-71325847V |
| 11 | Cage Sweep Drive | 1 | 71312339V | A-71312339V |
| 13 | Alternator Drive | 1 | 71352142 | A-71352142 |
| 14 | Tailings Drive | 1 | 71345785V | A-71345785V |
| 15 | Fan Drive | 1 | 71339886V | A-71339886V |
| 16 | Shoe Drive | 2 | 71336307V | A-71336307V |
| 17 | Jackshaft Drive (R60 - PRIOR TO SN 16501; R70 - PRIOR TO SN 12501) | 1 | 71313804 | A-71313804 |
| 17 | Jackshaft Drive (R60 - EFF. SN 16501; R70 - EFF. SN 12501) | 1 | 71354210V | A-71354210V |
| 18 | Distribution Auger Drive (R60 - PRIOR TO SN 16501; R70 - PRIOR TO SN 12501) | 1 | 71319657V | A-71319657V |
| 18 | Distribution Auger Drive (R60 - EFF. SN 16501; R70 - EFF. SN 12501) | 1 | 71348772V | A-71348772V |
| 19 | Compressor Drive | 1 | 71193420 | A-71193420 |

GLENER R60 - R70

| Belt No. |  | No. of Belts | OEM  Part No. | PIX  Part No. |
|----------|---|--------------|--|--|
| 21 | Impeller Drive (R60 - PRIOR TO SN 16501; R70 - PRIORTO SN 12501) | 1 | 71358134V | A-71358134V |
| 21 | Impeller Drive (R60 - EFF. SN 16501; R70 - EFF. SN 12501) | 2 | 71359681V | A-71359681V |
| 23 | Tailings Drive, Withtailings Return Option (R60 - EFF. SN16501; R70 - EFF.SN 12501) | 1 | 71337000V | A-71337000V |
| 26 | Straw Chopper Drive | 1 | 71358486V | A-71358486V |
| 27 | Chopper Jackshaft Drive | 1 | 71358487V | A-71358487V |
| 28 | Spreader Jackshaft Drive | 1 | 71347560V | A-71347560V |
| 29 | Spreader Drive | 1 | 71347561V | A-71347561V |



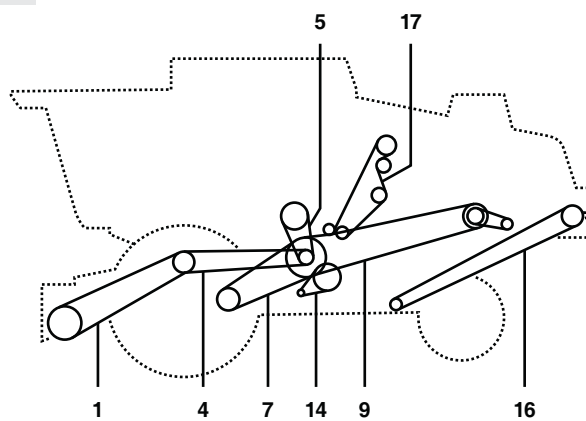
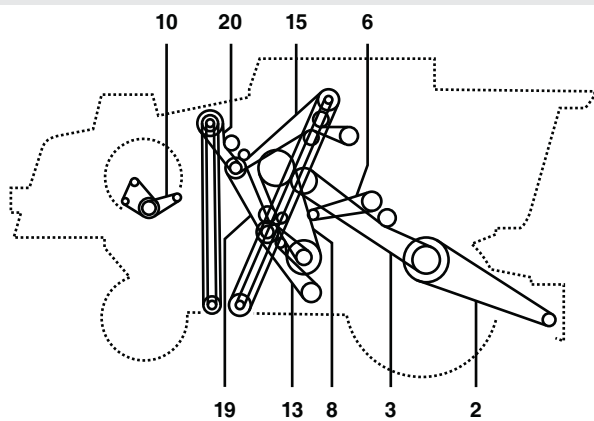

GLENER R62 - R72



| Belt No. |  | No. of Belts | OEM  Part No. | PIX  Part No. |
|----------|---|--------------|--|--|
| 1 | Constant Speed Header Drive (R62 - EFF. SN 68001; R72 - EFF. SN 78001) | 1 | 71364514 | A-71364514 |
| 1 | Variable Speed Header Drive (R62 - EFF. SN 68001; R72 - EFF. SN 78001) | 1 | 71390885 | A-71390885 |
| 1 | Variable Speed Header Drive (R62 - PRIOR TO SN 68000; R72 - PRIOR TO SN 78000) | 1 | 71390886 | A-71390886 |
| 2 | Right Hand Pivot Shaft Drive (R62 - PRIOR TO SN 63001; R72 - PRIOR TO SN 73001) | 1 | 71364155 | A-71364155 |
| 2 | Right Hand Pivot Shaft Drive (R 62 - EFF. SN 63001; R72 - EFF. SN 73001) | 1 | 71374306 | A-71374306 |
| 3 | Rear Feed Conveyor Drive | 1 | 71335475 | A-71335475 |
| 4 | Pivot Jackshaft Drive (2b) | 1 | 71355232 | A-71355232 |
| 4 | Pivot Jackshaft Drive (2c) (r62 - Eff. Sn 68001; R72 - Eff. Sn 78001) | 1 | 71377787 | A-71377787 |
| 5 | Bin Unloader Drive Lh | 1 | 71398366 | A-71398366 |
| 5 | Bin Unloader Drive Lh, Turret (r62 - Eff. Sn 68001; R72 - Eff. Sn 78001) | 1 | 71380601 | A-71380601 |
| 7 | Hydro Drive (r 62 - Prior To Sn 66001; R72 - Eff. To Sn 76001) | 1 | 71363595 | A-71363595 |
| 7 | Hydro Drive (r 62 - Prior To Sn 66001; R72 - Eff. To Sn 76001) | 1 | 71374276 | A-71374276 |
| 8 | Cylinder Drive | 1 | 71399514 | A-71399514 |
| 9 | Main Drive (r62 - Prior to Sn 63001; R72 - Prior To Sn 73001) | 1 | 71363804 | A-71363804 |
| 9 | Main Drive (r62 - Eff. Sn 63001 - 64001) | 1 | 71366207 | A-71366207 |
| 9 | Main Drive (r62 - Eff. Sn 64001) | 1 | 71368135 | A-71368135 |
| 9 | Main Drive (r72 - Eff. Sn 73001) | 1 | 71370279 | A-71370279 |
| 9 | Main Drive, Air Cooled (r62 - Prior To Sn 68000; R72 - Prior To Sn 78000) | 1 | 71370214 | A-71370214 |
| 10 | Alternator / Fan Drive, With Qsc (r62 - Eff. Sn Mj62101) | 1 | 3289470 | A-3289470 |
| 10 | A/c Compressor Drive (r62 - Eff. Sn 68001) | 1 | 71369747 | A-71369747 |
| 10 | Alternator Drive (r72 - Eff. Sn 78001) | 1 | 3028521V | A-3028521V |
| 10 | Fan Drive, 48.5" O.I., option (r72 - Eff. Sn 78001) | 1 | A3288623 | A-A3288623 |
| 10 | A/c Compressor Drive (r72 - Eff. Sn 79001) | 1 | 71148120 | A-71148120 |
| 13 | Separator Drive | 1 | 71363802 | A-71363802 |

GLENER R62 - R72

| Belt No. |  | No. of Belts | OEM  Part No. | PIX  Part No. |
|----------|--|--------------|--|--|
| 14 | SHOE DRIVE (R62 - PRIOR TO SN 66001; R72 - PRIOR TO SN 76001) | 1 | 71364077 | A-71364077 |
| 14 | SHOE DRIVE (R62 - EFF. SN 66001; R72 - EFF. TO SN 76001) | 1 | 71374305 | A-71374305 |
| 15 | CLEAN GRAIN ELEVATOR DRIVE | 1 | 71368809 | A-71368809 |
| 16 | STRAW SPREADER DRIVE | 1 | 71355170 | A-71355170 |
| 17 | CHOPPER / IMPELLER DRIVE (R62 - EFF. SN 68001; R72 - EFF. SN 78001) | 1 | 71386695 | A-71386695 |
| 17 | REAR FEED / FINE CUT CHOPPER DRIVE (R62 - EFF. SN 68001; R72 - EFF. SN 78001) | 1 | 71381955 | A-71381955 |
| 19 | JACKSHAFT DRIVE RH (R62 - PRIORTO SN 63001; R72 - PRIOR TO SN 73001) | 1 | 71363793 | A-71363793 |
| 19 | JACKSHAFT DRIVE RH (R62 - PRIORTO SN 63001; R72 - PRIOR TO SN 73001) | 1 | 71367469 | A-71367469 |
| 20 | TAILINGS DRIVE (R62 - EFF. SN 68001; R72 - EFF. SN 78001) | 1 | 71367459 | A-71367459 |
| 20 | TAILINGS DRIVE, WITH TAILINGS RETURN (R62 - EFF. SN 68001; R72 - EFF. SN 78001) | 1 | 71367460 | A-71367460 |
| 0 | SPREADER PUMP DRIVE (R62 - EFF. SN 68001; R72 - EFF. SN 78001) | 1 | 71379787 | A-71379787 |

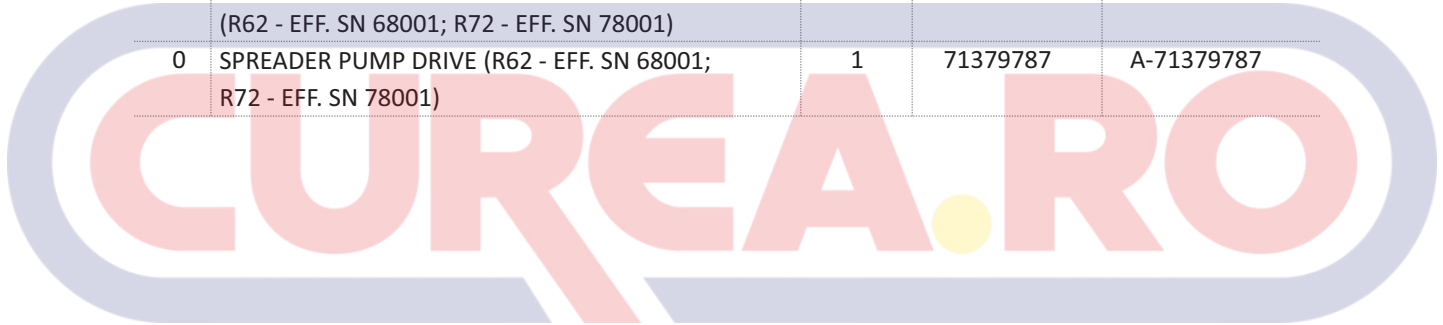



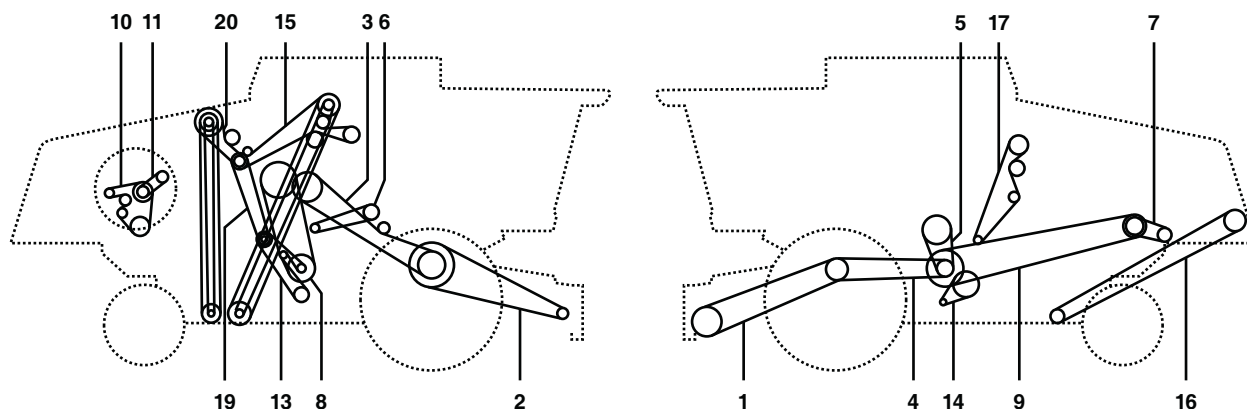

GLENER R65 - R75

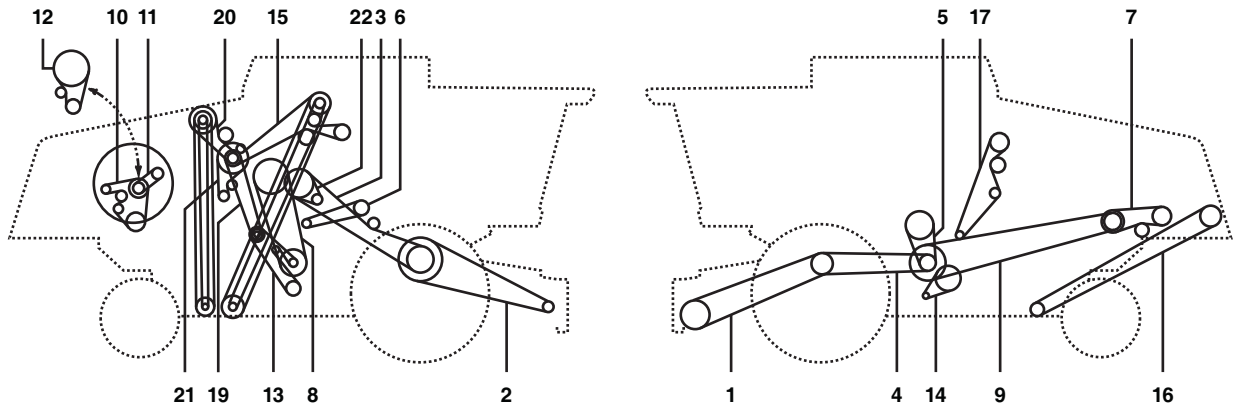

| Belt No. |  | No. of Belts | OEM  Part No. | PIX  Part No. |
|----------|---|--------------|--|--|
| 1 | Variable Speed Header Drive | 1 | 71390885 | A-71390885 |
| 1 | Constant Speed Header Drive | 1 | 71364514 | A-71364514 |
| 2 | Right Hand Pivot Shaft Drive (R65 - Prior Tosn HS62101; R75 - Prior To Snhs72101) | 1 | 71374306 | A-71374306 |
| 2 | Right Hand Pivot Shaft Drive (R65 - Eff. Sn HS62101; R75 - Eff. Sn Hs72101) | 1 | 71368809 | A-71368809 |
| 3 | Rear Feed Conveyor Drive | 1 | 71335475 | A-71335475 |
| 4 | Pivot Jackshaft Drive | 1 | 71377787 | A-71377787 |
| 5 | Bin Unloader Drive, Lh | 1 | 71398366 | A-71398366 |
| 5 | Bin Unloader Drive, Lh With Turret | 1 | 71380601 | A-71380601 |
| 7 | Propel Pump Drive Hydro (R65 - Prior To Sn HR62101) | 1 | 71418977 | A-71418977 |
| 7 | Propel Pump Drive Hydro (Eff. Sn HR62101) | 1 | 71390561 | A-71390561 |
| 8 | Cylinder Drive | 1 | 71399514 | A-71399514 |
| 9 | Main Drive (R65) | 1 | 71368135 | A-71368135 |
| 9 | Main Drive (R75) | 1 | 71370279 | A-71370279 |
| 10 | Alternator / Fan Drive (R65 - Prior To Sn HR62101) (Cummins) | 1 | A3289503 | A-A3289503 |
| 10 | Alternator / Fan Drive (R75 - Prior To Sn HR72101) (Cummins) | 1 | 3028521V | A-3028521V |
| 10 | Alternator / Fan Drive (eff. Sn HR62101) | 1 | V685121585 | A-V685121585 |
| 10 | Alternator / Fan Drive (prior. Eng. Sn T11858) | 1 | V685121585 | A-V685121585 |
| 10 | Alternator / Fan Drive (eff. Eng. Sn T11858) | 1 | V685121530 | A-V685121530 |
| 10 | Fan Drive, 48.5" O.I., Option (R75 - Prior To Sn HR72101) (cummins) | 1 | A3288623 | A-A3288623 |
| 11 | A/c Compressor Drive (R65 - Prior To Sn HR62101) | 1 | 71369747 | A-71369747 |
| 11 | A/c Compressor Drive (R65 - Eff. Sn Hr62101) | 1 | 71148120 | A-71148120 |
| 13 | Separator Drive | 1 | 71363802 | A-71363802 |
| 14 | Shoe Drive | 1 | 71374305 | A-71374305 |
| 15 | Clean Grain Elevator Drive | 1 | 71368809 | A-71368809 |
| 16 | Straw Spreader Drive | 1 | 71355170 | A-71355170 |
| 17 | Impeller / Chopper Drive | 1 | 71386695 | A-71386695 |
| 17 | Fine Cut Chopper Drive | 1 | 71381955 | A-71381955 |
| 19 | Right Hand Jackshaft Drive | 1 | 71367469 | A-71367469 |
| 20 | Tailings Drive | 1 | 71367459 | A-71367459 |
| 20 | Tailings Drive, With Tailings Return | 1 | 71367460 | A-71367460 |
| 0 | Spreader Pump Drive | 1 | 71379787 | A-71379787 |



GLENER R66 - R76



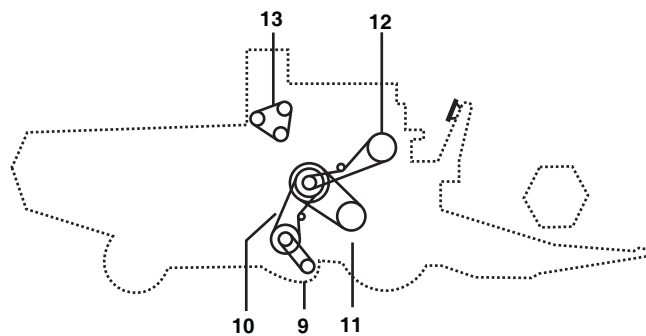
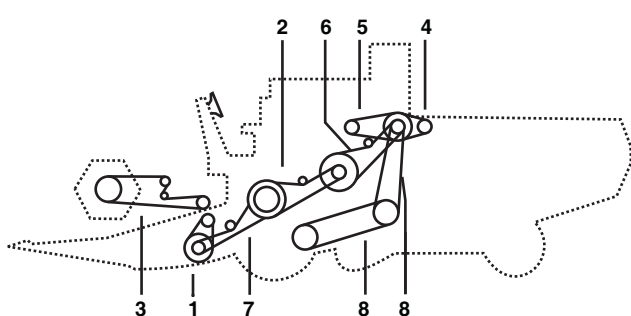

| Belt No. |  | No. of Belts | OEM  Part No. | PIX  Part No. |
|----------|---|--------------|--|--|
| 1 | Variable Speed Header Drive | 1 | 71390885 | A-71390885 |
| 1 | Constant Speed Header Drive | 1 | 71364514 | A-71364514 |
| 2 | Right Hand Pivot Shaft Drive | 1 | 71427254 | A-71427254 |
| 3 | Rear Feed Conveyer Drive | 1 | 71335475 | A-71335475 |
| 4 | Lh Pivot Jackshaft Drive | 1 | 71377787 | A-71377787 |
| 5 | Bin Unloader Drive, Lh (swivel) | 1 | 71426450 | A-71426450 |
| 5 | Bin Unloader Drive, Lh (turret) | 1 | 71380601 | A-71380601 |
| 7 | Propel Pump Drive | 1 | 71390561 | A-71390561 |
| 8 | Cylinder Drive | 1 | 71399514 | A-71399514 |
| 9 | Main Drive | 1 | 71370279 | A-71370279 |
| 10 | Alternator / Fan Drive | 1 | V685121530 | A-V685121530 |
| 11 | A/c Compressor Drive | 1 | 71148120 | A-71148120 |
| 12 | Rotary Screen Drive | 1 | 71396754 | A-71396754 |
| 13 | Separator Drive | 1 | 71363802 | A-71363802 |
| 14 | Shoe Drive | 1 | 71374305 | A-71374305 |
| 15 | Clean Grain Elevator Drive | 1 | 71368809 | A-71368809 |
| 16 | Straw Spreader Drive | 1 | 71355170 | A-71355170 |
| 17 | Impeller / Chopper Drive | 1 | 71386695 | A-71386695 |
| 17 | Fine Cut Chopper Drive | 1 | 71381955 | A-71381955 |
| 18 | Inner Slowdown (not Illustrated) | 1 | 71395108 | A-71395108 |
| 18 | Slowdown (not Illustrated) | 1 | 71394979 | A-71394979 |
| 19 | Rh Jackshaft Drive | 1 | 71367469 | A-71367469 |
| 19 | Rh Jackshaft Drive (popcorn Special) | 1 | 71368072 | A-71368072 |
| 20 | Tailings Drive | 1 | 71367459 | A-71367459 |
| 20 | Tailings Drive (with Tailings Return) | 1 | 71367460 | A-71367460 |
| 21 | Spreader Pump Drive (not Illustrated) | 1 | 71379787 | A-71379787 |

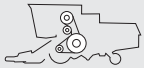
JOHN DEERE 330 - 430





| Belt No. |  | No. of Belts | OEM  Part No. | PIX  Part No. |
|----------|---|--------------|--|--|
| 1 | Reel Drive Variable Speed | 1 | Z20459 | A-Z20459 |
| 2 | Straw Elevator Drive | 1 | Z20460 | A-Z20460 |
| 3 | Reel Drive | 1 | Z20562 | A-Z20562 |
| 4 | Hydraulic Pump Drive | 1 | Z21171 | A-Z21171 |
| 4 | Hydraulic Pump Drive | 1 | Z21254 | A-Z21254 |
| 4 | Hydraulic Pump Drive | 1 | Z21137 | A-Z21137 |
| 4 | Hydraulic Pump Drive | 1 | Z23752 | A-Z23752 |
| 5 | Unloading System | 1 | Z21400 | A-Z21400 |
| 5 | Unloading System | 1 | Z21398 | A-Z21398 |
| 6 | Threshing Drum Variator Drive | 1 | Z21402 | A-Z21402 |
| 6 | Threshing Drum Variator Drive | 1 | Z21401 | A-Z21401 |
| 7 | Sickle Knife Drive | 1 | Z23693 | A-Z23693 |
| 8 | Traction Drive | 1 | H25645 | A-H25645 |
| 9 | Fan Drive Variable Speed | 1 | Z20459 | A-Z20459 |
| 10 | Fan Drive | 1 | Z20703 | A-Z20703 |
| 11 | Cylinder Drive | 1 | Z20823 | A-Z20823 |
| 12 | Rotary Screen - Elevator | 1 | Z20743 | A-Z20743 |

| Belt No. |  | No. of Belts | OEM  Part No. | PIX  Part No. |
|----------|---|--------------|--|--|
| 2 | - | 1 | N15201 | A-N15201 |
| 3 | - | 1 | L4490N | A-L4490N |
| 4 | - | 1 | E61137 | A-E61137 |
| 5 | - | 1 | N121114 | A-N121114 |
| 6 | - | 1 | E58483 | A-E58483 |
| 7 | - | 1 | N30716 | A-N30716 |
| 8 | - | 1 | N12551 | A-N12551 |
| 9 | - | 1 | N110051 | A-N110051 |
| 10 | - | 1 | N121235 | A-N121235 |



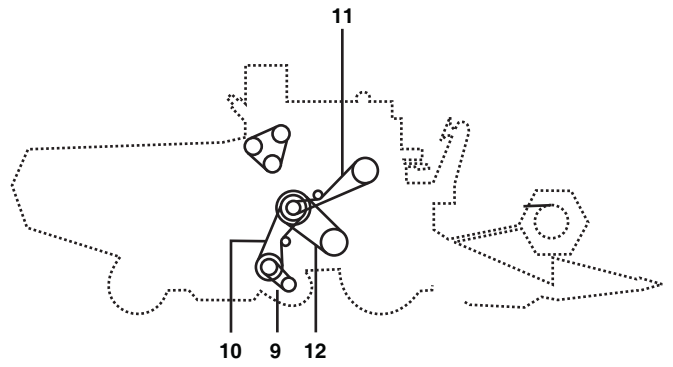
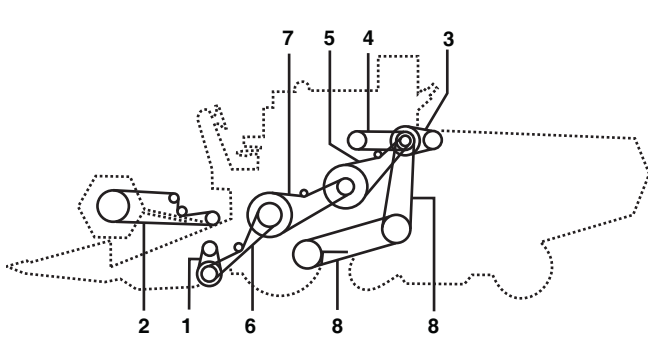

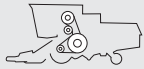

JOHN DEERE 530 - 630



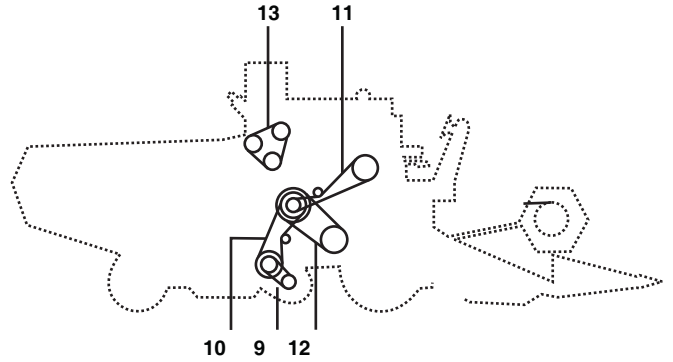
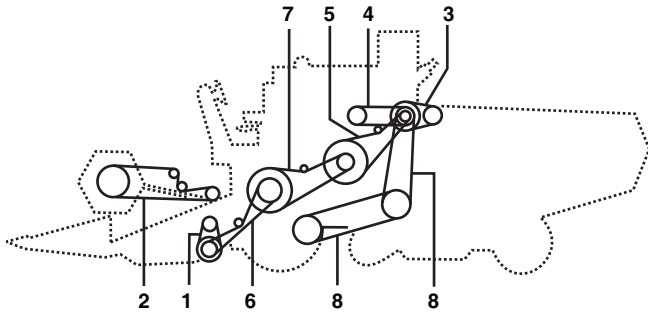

| Belt No. |  | No. of Belts | OEM  Part No. | PIX  Part No. |
|----------|---|--------------|--|--|
| 1 | Reel Drive Variable Speed | 1 | Z20459 | A-Z20459 |
| 2 | Reel Drive | 1 | Z20562 | A-Z20562 |
| 3 | Hydraulic Pump Drive | 1 | Z21171 | A-Z21171 |
| 3 | Hydraulic Pump Drive | 1 | Z21254 | A-Z21254 |
| 4 | Unloading System | 1 | Z21400 | A-Z21400 |
| 4 | Unloading System | 1 | Z21398 | A-Z21398 |
| 5 | Threshing Drum Variator Drive | 1 | Z21403 | A-Z21403 |
| 6 | Sickle Knife Drive | 1 | Z21500 | A-Z21500 |
| 7 | Straw Elevator Drive | 1 | Z21501 | A-Z21501 |
| 9 | Fan Drive Variable Speed | 1 | Z20459 | A-Z20459 |
| 10 | Fan Drive | 1 | Z20703 | A-Z20703 |
| 11 | Rotary Screen - Elevator | 1 | Z20743 | A-Z20743 |
| 12 | Cylinder Drive | 1 | Z20823 | A-Z20823 |
| 13 | Hydraulic Pump Drive - Engine | 1 | Z22208 | A-Z22208 |

JOHN DEERE 730



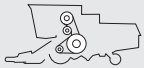

| Belt No. |  | No. of Belts | OEM  Part No. | PIX  Part No. |
|----------|---|--------------|--|--|
| 1 | Reel Drive Variable Speed | 1 | Z20459 | A-Z20459 |
| 2 | Reel Drive | 1 | Z20562 | A-Z20562 |
| 3 | Hydraulic Pump Drive | 1 | Z21254 | A-Z21254 |
| 4 | Unloading System | 1 | Z21400 | A-Z21400 |
| 5 | Sickle Knife Drive | 1 | Z21500 | A-Z21500 |
| 5 | Sickle Knife Drive | 1 | Z21501 | A-Z21501 |
| 6 | Straw Elevator Drive | 1 | Z21501 | A-Z21501 |
| 7 | Threshing Drum Variator drive | 1 | Z22648 | A-Z22648 |
| 9 | Fan Drive Variable Speed | 1 | Z20459 | A-Z20459 |
| 10 | Fan Drive | 1 | Z20703 | A-Z20703 |
| 11 | Rotary Screen - Elevator | 1 | Z20743 | A-Z20743 |
| 12 | Cylinder Drive | 1 | Z20823 | A-Z20823 |
| 13 | Hydraulic Pump Drive - Engine | 1 | Z22208 | A-Z22208 |

JOHN DEERE 800

| Belt No. |  | No. of Belts | OEM  Part No. | PIX  Part No. |
|----------|---|--------------|--|--|
| 1 | Fan Drive | 1 | E50973 | A-E50973 |
| 2 | Governor Drive | 1 | E57428 | A-E57428 |
| 3 | Drive (primary) | 2 | E48060 | A-E48060 |
| 4 | Drive (secondary) | 1 | AE31453 | A-AE31453 |
| 5 | Steering | 1 | E48063 | A-E48063 |



JOHN DEERE 830

| Belt No. |  | No. of Belts | OEM  Part No. | PIX  Part No. |
|----------|---|--------------|--|--|
| 1 | Fan Drive | 1 | E50973 | A-E50973 |
| 2 | Governor Drive | 1 | E57428 | A-E57428 |
| 3 | Drive (secondary) | 1 | AE31453 | A-AE31453 |
| 4 | Steering | 1 | E48063 | A-E48063 |
| 6 | Drive (primary) | 2 | E48060 | A-E48060 |

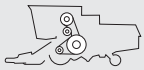

JOHN DEERE 880

| Belt No. |  | No. of Belts | OEM  Part No. | PIX  Part No. |
|----------|---|--------------|--|--|
| 2 | Platform Drive | 1 | E37821 | A-E37821 |

JOHN DEERE 900 - 900 R - 900 F

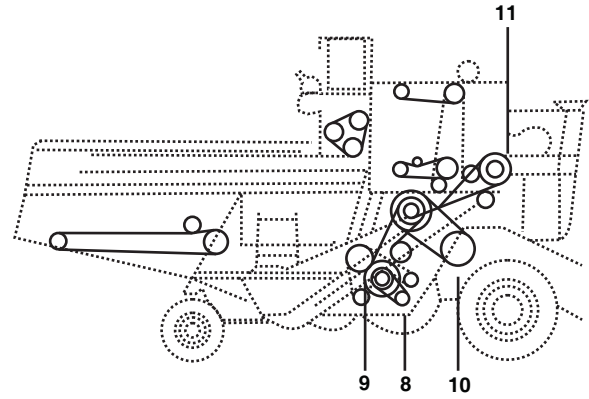
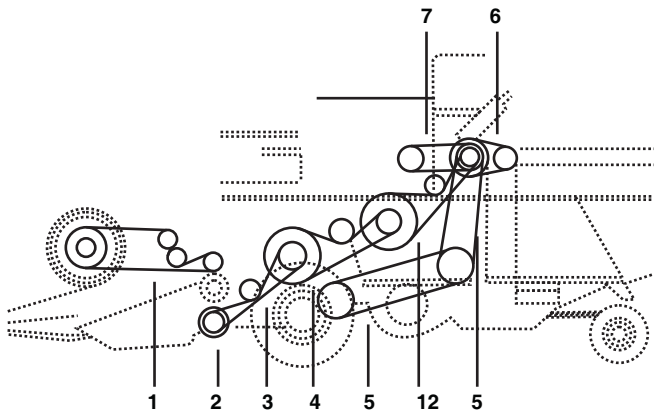

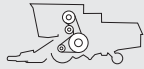
| Belt No. |  | No. of Belts | OEM  Part No. | PIX  Part No. |
|----------|---|--------------|--|--|
| 1 | - | 1 | H136963 | A-H136963 |
| 2 | - | 1 | H202646 | A-H202646 |
| 3 | - | 1 | H202647 | A-H202647 |





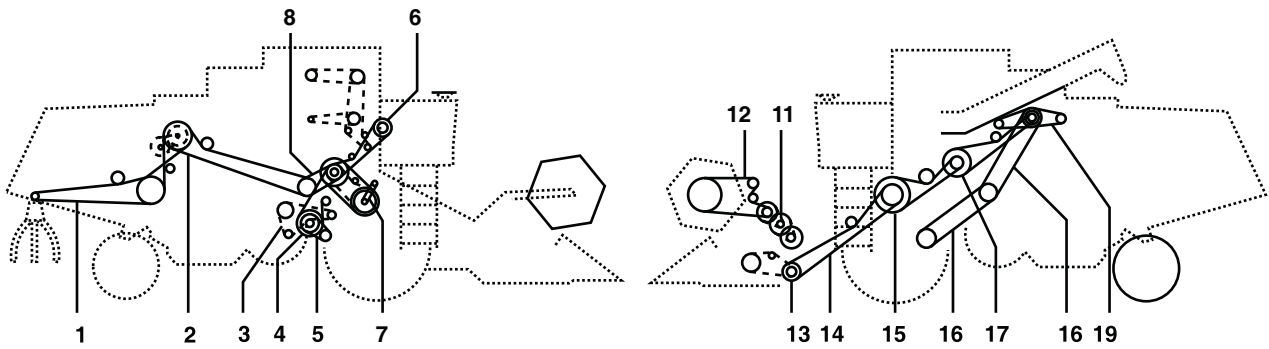

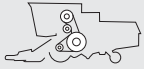
| Belt No. |  | No. of Belts | OEM  Part No. | PIX  Part No. |
|----------|---|--------------|--|--|
| 1 | Reel Drive | - | Z20562 | A-Z20562 |
| 2 | Reel Variator Drive | - | Z36813 | A-Z36813 |
| 3 | Knife Drive | - | Z23693 | A-Z23693 |
| 4 | Straw Elevator | - | Z20460 | A-Z20460 |
| 5 | Traction Vari Drive | - | Z36120 | A-Z36120 |
| 6 | Hydraulic Pump | - | Z30593 | A-Z30593 |
| 7 | Tank Discharge | - | Z21400 | A-Z21400 |
| 8 | Air Fan | - | Z20459 | A-Z20459 |
| 9 | Fan Drive | - | Z20703 | A-Z20703 |
| 11 | Rotary Screen | - | Z20743 | A-Z20743 |

JOHN DEERE 930 - 940

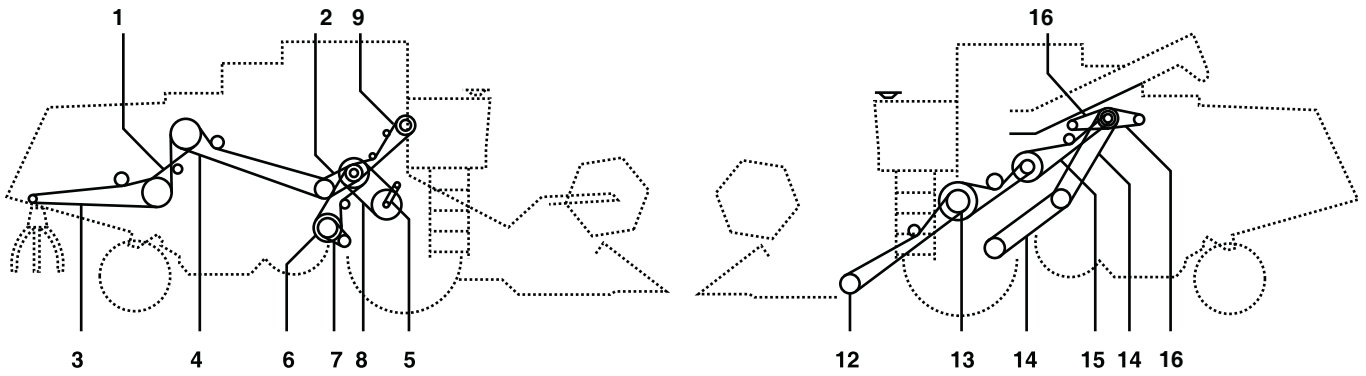



| Belt No. |  | No. of Belts | OEM  Part No. | PIX  Part No. |
|----------|---|--------------|--|--|
| 1 | Straw Spreader Drive | 1 | Z32041 | A-Z32041 |
| 1 | Straw Spreader | 1 | Z32158 | A-Z32158 |
| 3 | Fan Drive | 1 | Z20703 | A-Z20703 |
| 4 | Fan Drive Variable Speed | 1 | Z20459 | A-Z20459 |
| 5 | Cylinder Variator Drive | 1 | Z20823 | A-Z20823 |
| 6 | Rotary Screen Drive | 1 | Z20743 | A-Z20743 |
| 8 | Straw Walker Drive (940) | 1 | Z30920 | A-Z30920 |
| 9 | (940) | 1 | Z32883 | A-Z32883 |
| 10 | Purify Drive | 1 | Z31283 | A-Z31283 |
| 11 | Rotary Screen Drive | 1 | Z28458 | A-Z28458 |
| 12 | Reel Drive (930) | 1 | Z20562 | A-Z20562 |
| 13 | Reel Drive Variable Speed (930) | 1 | Z36813 | A-Z36813 |
| 14 | Sickle Knife Drive (930) | 1 | Z23693 | A-Z23693 |
| 14 | Sickle Knife Drive | 1 | Z30130 | A-Z30130 |
| 15 | Straw Elevator Drive (930) | 1 | Z31816 | A-Z31816 |
| 15 | Straw Elevator Drive | 1 | Z21501 | A-Z21501 |
| 16 | Traction Variator Drive | 1 | Z31367 | A-Z31367 |
| 17 | Threshing Drum Variator Drive | 1 | Z31191 | A-Z31191 |
| 18 | Unloading System | 1 | Z21400 | A-Z21400 |
| 19 | Hydraulic Pump Drive | 1 | Z30593 | A-Z30593 |



| Belt No. |  | No. of Belts | OEM  Part No. | PIX  Part No. |
|----------|---|--------------|--|--|
| 1 | - | 1 | Z32883 | A-Z32883 |
| 2 | Straw Walker Drive | 1 | Z25473 | A-Z25473 |
| 3 | Straw Spreader Drive | 1 | Z32041 | A-Z32041 |
| 3 | - | 1 | Z33774 | A-Z33774 |
| 4 | Straw Walker Drive | 1 | Z30920 | A-Z30920 |
| 6 | Fan Drive | 1 | Z20703 | A-Z20703 |
| 7 | Fan Drive Variable Speed | 1 | Z20459 | A-Z20459 |
| 8 | Cylinder Variator drive | 1 | Z20823 | A-Z20823 |
| 9 | Rotary Screen Drive | 1 | Z20743 | A-Z20743 |
| 10 | Purify Drive | 1 | Z31283 | A-Z31283 |
| 12 | Sickle Knife Drive | 1 | Z30130 | A-Z30130 |
| 12 | Sickle Knife Drive | 1 | Z25670 | A-Z25670 |
| 13 | Straw Elevator Drive | 1 | Z21501 | A-Z21501 |
| 13 | Straw Elevator Drive | 1 | Z32568 | A-Z32568 |
| 14 | Traction Vari Drive | 2 | Z34121 | A-Z34121 |
| 15 | Threshing Drum Variator drive | 1 | Z21403 | A-Z21403 |
| 16 | Unloading System | 1 | Z21400 | A-Z21400 |
| 17 | Hydraulic Pump Drive | 1 | Z30593 | A-Z30593 |

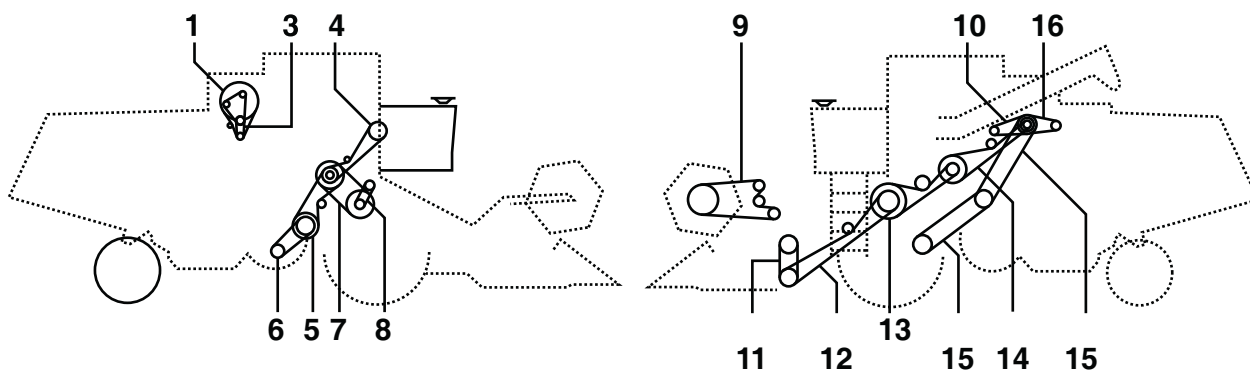

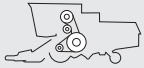
JOHN DEERE 952



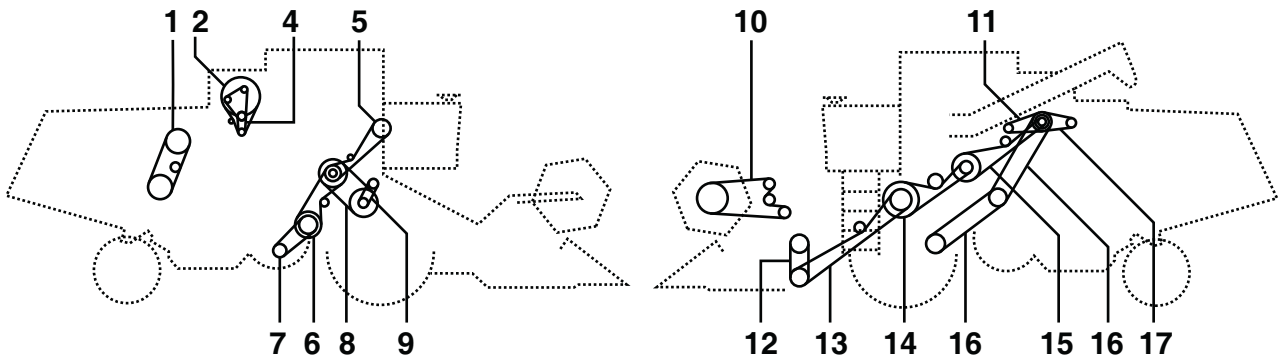

| Belt No. |  | No. of Belts | OEM  Part No. | PIX  Part No. |
|----------|---|--------------|--|--|
| 1 | Purify Drive | 1 | Z31283 | A-Z31283 |
| 3 | Waterpump Drive | 1 | Z32190 | A-Z32190 |
| 4 | Rotary Screen Drive | 1 | Z20743 | A-Z20743 |
| 5 | Fan Drive | 1 | Z34405 | A-Z34405 |
| 6 | Fan Drive Variable Speed | 1 | Z41178 | A-Z41178 |
| 7 | Cylinder Variator Drive | 1 | Z20823 | A-Z20823 |
| 9 | Reel Drive | 1 | Z20562 | A-Z20562 |
| 10 | - | 1 | Z21400 | A-Z21400 |
| 11 | Reel Drive Variable Speed | 1 | Z36813 | A-Z36813 |
| 11 | Reel Drive Variable Speed | 1 | Z30692 | A-Z30692 |
| 12 | Sickle Knife Drive | 1 | Z30130 | A-Z30130 |
| 12 | Sickle Knife Drive | 1 | Z39313 | A-Z39313 |
| 13 | Straw Elevator Drive | 1 | Z32568 | A-Z32568 |
| 13 | Straw Elevator Drive | 1 | Z21501 | A-Z21501 |
| 14 | Main Drive | 1 | Z31191 | A-Z31191 |
| 15 | Traction Vari Drive | 2 | Z36376 | A-Z36376 |
| 16 | Hydraulic Pump Drive | 1 | Z30593 | A-Z30593 |

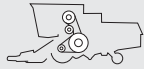
JOHN DEERE 955



| Belt No. |  | No. of Belts | OEM  Part No. | PIX  Part No. |
|----------|---|--------------|--|--|
| 1 | Straw Walker Drive | 1 | Z32883 | A-Z32883 |
| 2 | Purify Drive | 1 | Z31283 | A-Z31283 |
| 4 | Waterpump Drive | 1 | Z32190 | A-Z32190 |
| 5 | Rotary Screen Drive | 1 | Z20743 | A-Z20743 |
| 6 | Fan Drive | 1 | Z34405 | A-Z34405 |
| 7 | Fan Drive Variable Speed | 1 | Z41178 | A-Z41178 |
| 8 | Cylinder Variator drive (sub For Z20823) | 1 | Z53288 | A-Z53288 |
| 10 | Reel Drive | 1 | Z44740 | A-Z44740 |
| 11 | - | 1 | Z21400 | A-Z21400 |
| 12 | Reel Drive Variable Speed | 1 | Z36813 | A-Z36813 |
| 12 | Reel Drive Variable Speed | 1 | Z30692 | A-Z30692 |
| 13 | Sickle Knife Drive (Sr. Nr. Before 024652-Ord Z39313) | 1 | Z30130 | A-Z30130 |
| 13 | Sickle Knife Drive (Sr. Nr. 024653- ... /Sub for Z30130) | 1 | Z39313 | A-Z39313 |
| 13 | Sickle Knife Drive | 1 | Z25670 | A-Z25670 |
| 14 | Straw Elevator Drive | 1 | Z32568 | A-Z32568 |
| 14 | Straw Elevator Drive | 1 | Z21501 | A-Z21501 |
| 15 | Main Drive | 1 | Z21403 | A-Z21403 |
| 16 | Traction Vari Drive (Before Ser. No. 026952) | 2 | Z34121 | A-Z34121 |
| 16 | Traction Vari Drive (After Ser No. 026953) | 2 | Z33967 | A-Z33967 |
| 17 | Hydraulic Pump Drive | 1 | Z34828 | A-Z34828 |



JOHN DEERE 965 - 965 HYDRO 4 - 975

| Belt No. |  | No. of Belts | OEM  Part No. | PIX  Part No. |
|----------|---|--------------|--|--|
| 1 | Reel Drive | 1 | Z20562 | A-Z20562 |
| 2 | Reel Drive Variable Speed | 1 | Z20459 | A-Z20459 |
| 3 | Main Drive | 1 | Z33790 | A-Z33790 |
| 4 | Unloading System | 1 | Z33368 | A-Z33368 |
| 5 | Hydraulic Pump Drive | 1 | Z34828 | A-Z34828 |
| 6 | Traction Drive | 2 | AZ22914 | A-AZ22914 |
| 8 | Straw Elevator Drive | 1 | Z21500 | A-Z21500 |
| 10 | Radiator Fan Drive | 1 | Z24833 | A-Z24833 |
| 11 | Purify Drive | 1 | Z31283 | A-Z31283 |
| 12 | Countershaft - Purify Drive | 1 | Z32190 | A-Z32190 |
| 13 | Cylinder Drive | 1 | Z20823 | A-Z20823 |
| 14 | Fan Drive | 1 | Z34405 | A-Z34405 |
| 15 | Sickle Knife Drive | 1 | Z30130 | A-Z30130 |



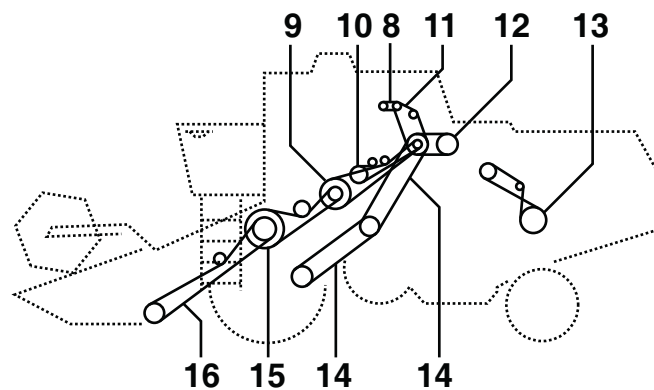
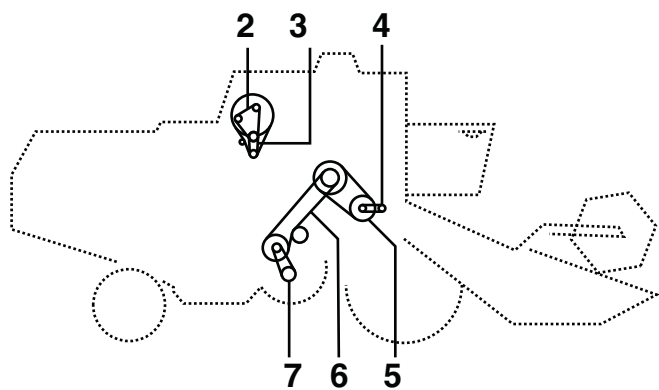

JOHN DEERE 965 - 965 HYDRO - 968 HYDRO



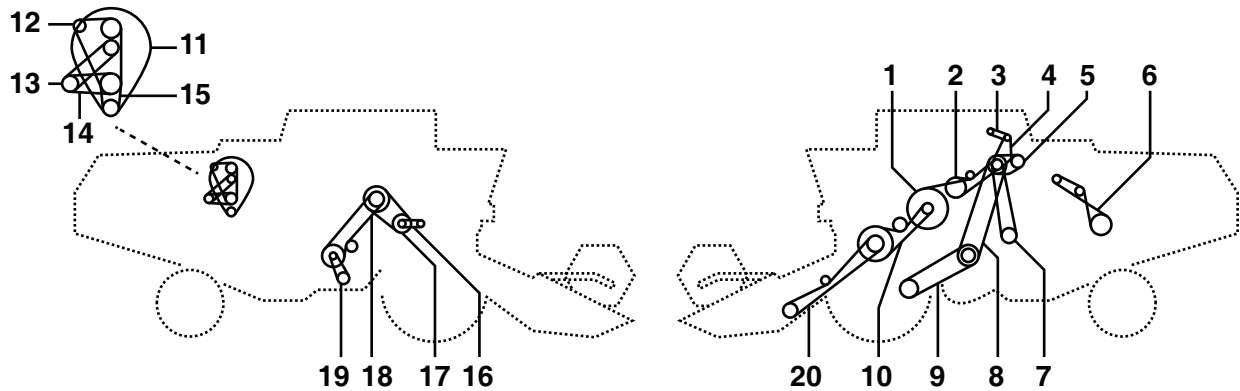

| Belt No. |  | No. of Belts | OEM  Part No. | PIX  Part No. |
|----------|---|--------------|--|--|
| 2 | Purify Drive | 1 | Z31283 | A-Z31283 |
| 3 | Countershaft - Purify Drive | 1 | Z32190 | A-Z32190 |
| 5 | Cylinder Drive | 1 | Z20823 | A-Z20823 |
| 6 | Fan Drive | 1 | Z34405 | A-Z34405 |
| 7 | Fan Drive Variable Speed | 1 | Z41178 | A-Z41178 |
| 8 | - | 1 | CA20514 | A-CA20514 |
| 9 | Main Drive | 1 | Z33790 | A-Z33790 |
| 10 | - | 1 | Z47911 | A-Z47911 |
| 11 | - | 1 | CA20518 | A-CA20518 |
| 12 | Hydraulic Pump Drive | 1 | Z34828 | A-Z34828 |
| 13 | (ser Nr Prior 026422) 965 - 965 Hydro | 1 | Z33605 | A-Z33605 |
| 13 | (ser Nr Following 026423) | 1 | Z35965 | A-Z35965 |
| 14 | Traction Drive | 1 | Z33967 | A-Z33967 |
| 15 | Straw Elevator Drive | 1 | Z38186 | A-Z38186 |
| 15 | Straw Elevator Drive | 1 | Z21501 | A-Z21501 |
| 16 | Sickle Knife Drive (ser Nr Prior To 024652) (965) | 1 | Z30130 | A-Z30130 |
| 16 | Sickle Knife Drive (ser Nr Following To 024653) (965) | 1 | Z36949 | A-Z36949 |
| 16 | Sickle Knife Drive (ser Nr Prior To 024652) (965) | 1 | Z39313 | A-Z39313 |
| 16 | Sickle Knife Drive (ser Nr Following To 024653) (965) | 1 | Z39314 | A-Z39314 |
| 16 | Sickle Knife Drive (ser Nr Prior To 024652) (965 Hydro - 968 Hydro) | 1 | Z25670 | A-Z25670 |
| 16 | Sickle Knife Drive (ser Nr Following To 024653) (965 Hydro - 968 Hydro) | 1 | Z39312 | A-Z39312 |

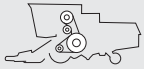
JOHN DEERE 975 - 975 HYDRO 4



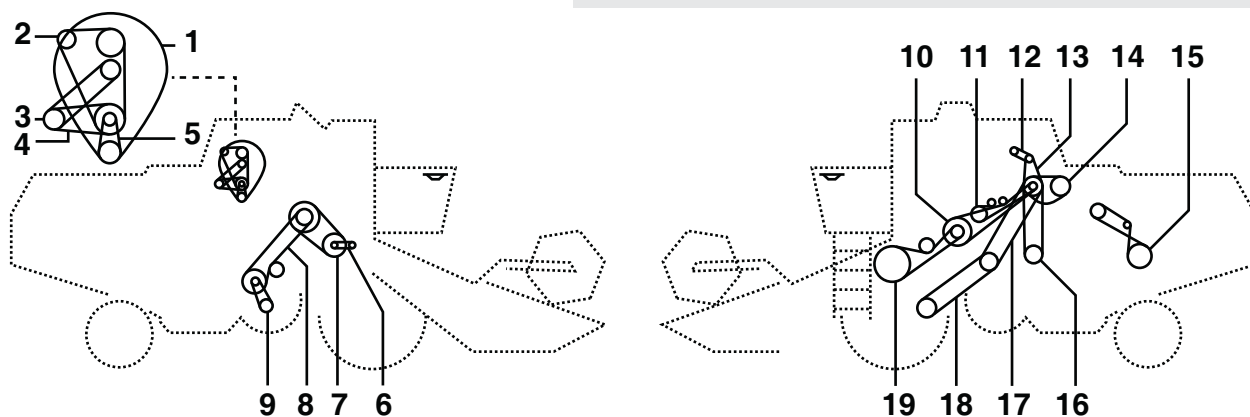

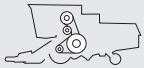

| Belt No. |  | No. of Belts | OEM  Part No. | PIX  Part No. |
|----------|---|--------------|--|--|
| 1 | Separator Andcleaning Unit | 1 | Z33790 | A-Z33790 |
| 2 | Grain Tank Unloading Drive | 1 | Z47911 | A-Z47911 |
| 3 | Ventilator Drive | 1 | CA20514 | A-CA20514 |
| 4 | Ventilator Drive | 1 | CA20518 | A-CA20518 |
| 5 | Hydraulic Pump Drive | 1 | Z34828 | A-Z34828 |
| 6 | Separator & cleaning Unit(Ser Nr following to 024653) | 1 | Z35965 | A-Z35965 |
| 6 | Separator & cleaning Unit(Ser Nr Priorto 024653) | 1 | Z33605 | A-Z33605 |
| 7 | Main Drive (sub For Z37476) | 1 | Z41728 | A-Z41728 |
| 8 | (975) | 2 | AZ22914 | A-AZ22914 |
| 9 | (975) | 1 | Z34099 | A-Z34099 |
| 10 | Feeder House | 1 | Z38186 | A-Z38186 |
| 10 | Feeder House | 1 | Z21501 | A-Z21501 |
| 11 | Alternator Drive (975 Hydro 4) | 2 | Z37192 | A-Z37192 |
| 12 | Alternator Drive (ser Nr Prior To 389082) (975) | 2 | AT24833 | A-AT24833 |
| 12 | Engine Purify Drive (975 Hydro 4) | 1 | H79235 | A-H79235 |
| 12 | Engine Purify Drive (ser Nr Following To 389083) (975) | 1 | AR72036 | A-AR72036 |
| 13 | (975 Hydro 4) | 1 | Z38149 | A-Z38149 |
| 14 | Separator Andcleaning Unit (975 Hydro 4) | 1 | Z38148 | A-Z38148 |
| 15 | (975) | 1 | Z32190 | A-Z32190 |
| 15 | Cylinder Drive Variable (975 Hydro) | 1 | Z37191 | A-Z37191 |
| 17 | Cylinder Drive Variable | 1 | Z20823 | A-Z20823 |
| 18 | Fan Drive | 1 | Z34405 | A-Z34405 |
| 19 | Separator Andcleaning Unit | 1 | Z41178 | A-Z41178 |
| 20 | Feeder House (ser Nr 013568 To 024652) | 1 | Z36949 | A-Z36949 |
| 20 | Feeder House (ser Nr Following To 024653) | 1 | Z39314 | A-Z39314 |
| 20 | Feeder House (ser Nr Prior To 013567) (975) | 1 | Z25670 | A-Z25670 |

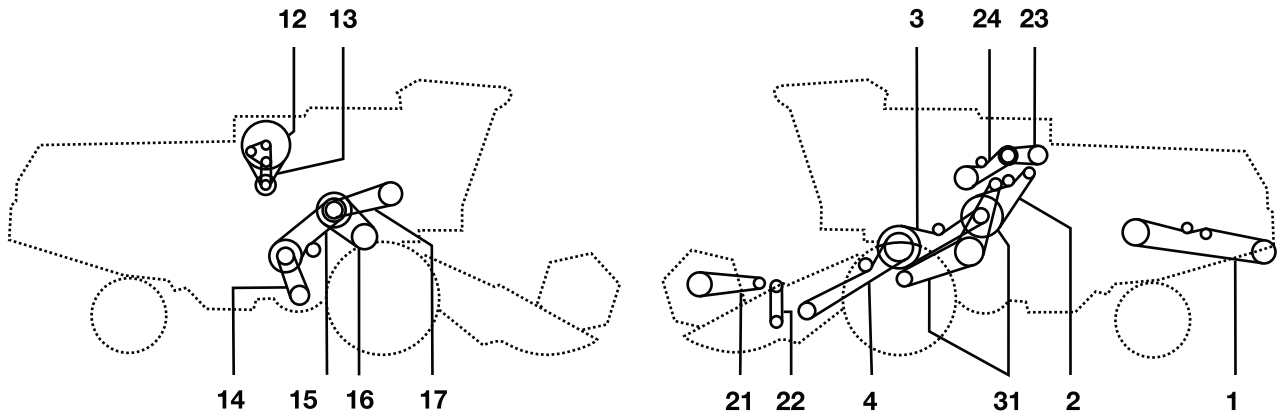

| Belt No. |  | No. of Belts | OEM  Part No. | PIX  Part No. |
|----------|---|--------------|--|--|
| 1 | Purify Drive (985) | 1 | Z37192 | A-Z37192 |
| 1 | Purify Drive | 1 | Z38704 | A-Z38704 |
| 2 | Fan Drive (985) | 1 | H79235 | A-H79235 |
| 3 | (985) | 1 | Z38149 | A-Z38149 |
| 3 | Return Purify Drive | 1 | Z38703 | A-Z38703 |
| 4 | Waterpump Drive (985) | 1 | Z38148 | A-Z38148 |
| 4 | - | 1 | Z38702 | A-Z38702 |
| 5 | (985) | 1 | Z37191 | A-Z37191 |
| 5 | - | 1 | Z38692 | A-Z38692 |
| 7 | Cylinder | 1 | Z37473 | A-Z37473 |
| 8 | Fan Drive | - | Z34405 | A-Z34405 |
| 9 | Fan Drive Variable Speed | 1 | Z41178 | A-Z41178 |
| 10 | Main (prior To Ser Nr 018432) (985) | 1 | Z33790 | A-Z33790 |
| 10 | Main (following To Ser Nr 018433) | 1 | Z38697 | A-Z38697 |
| 11 | Unloading Drive (prior Ser Nr xxxx / Sub Forz33368) (985) | 1 | Z47911 | A-Z47911 |
| 11 | Unloading Drive (following Ser Nr xxxx / Sub For Z38698) | 1 | Z47912 | A-Z47912 |
| 12 | Engine Fan Drive | 1 | CA20514 | A-CA20514 |
| 13 | Hydraulic Pump Drive - Engine | 1 | CA20518 | A-CA20518 |
| 14 | Hydraulic Pump Drive | 1 | Z34828 | A-Z34828 |
| 15 | Straw Discharge (prior Ser Nr 026422) | 1 | Z33605 | A-Z33605 |
| 15 | Straw Discharge (following Ser Nr 026423) | 1 | Z35965 | A-Z35965 |
| 16 | (985 Hydro) | 1 | Z41563 | A-Z41563 |
| 17 | Traction (upper) (985) | 2 | AZ22914 | A-AZ22914 |
| 18 | Traction (lower) (985) | 1 | Z34099 | A-Z34099 |
| 19 | Main Drive | 1 | Z38186 | A-Z38186 |



JOHN DEERE 1032 - 1042 - 1052



| Belt No. |  | No. of Belts | OEM  Part No. | PIX  Part No. |
|----------|---|--------------|--|--|
| 1 | Straw Walker Drive | 1 | Z33774 | A-Z33774 |
| 2 | - | 1 | Z46222 | A-Z46222 |
| 2 | Cutting Table Drive Lead-in | 1 | Z31191 | A-Z31191 |
| 3 | Lead-in Drive | 1 | Z38186 | A-Z38186 |
| 3 | Lead-in Drive | 1 | Z20460 | A-Z20460 |
| 3 | Lead-in Drive | 1 | Z21501 | A-Z21501 |
| 4 | Cutting Table Drive | 1 | Z23693 | A-Z23693 |
| 4 | Cutting Table Drive | 1 | Z46874 | A-Z46874 |
| 4 | Cutting Table Drive | 1 | Z39313 | A-Z39313 |
| 12 | Rotary Screen Drive | 1 | Z31283 | A-Z31283 |
| 13 | Rotary Screen Drive | 1 | Z32190 | A-Z32190 |
| 14 | Fan Drive Variable Speed | 1 | Z41178 | A-Z41178 |
| 15 | Fan Drive Variable Speed | 1 | Z34405 | A-Z34405 |
| 16 | Cylinder Variator Drive | 1 | Z53288 | A-Z53288 |
| 17 | Elevator Drive Unit | 1 | Z20743 | A-Z20743 |
| 21 | - | 1 | Z44740 | A-Z44740 |
| 22 | Reel Drive Variable Speed | 1 | Z36813 | A-Z36813 |
| 23 | Hydraulic Pump Drive | 1 | Z42382 | A-Z42382 |
| 24 | Discharge Beater Drive | 1 | Z43253 | A-Z43253 |
| 31 | Main Drive | 1 | Z36120 | A-Z36120 |

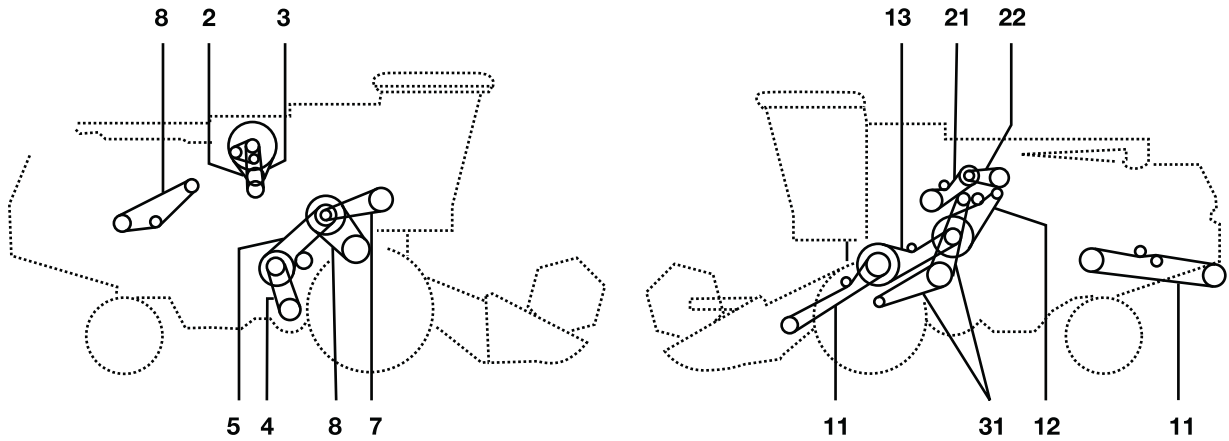

JOHN DEERE 1055



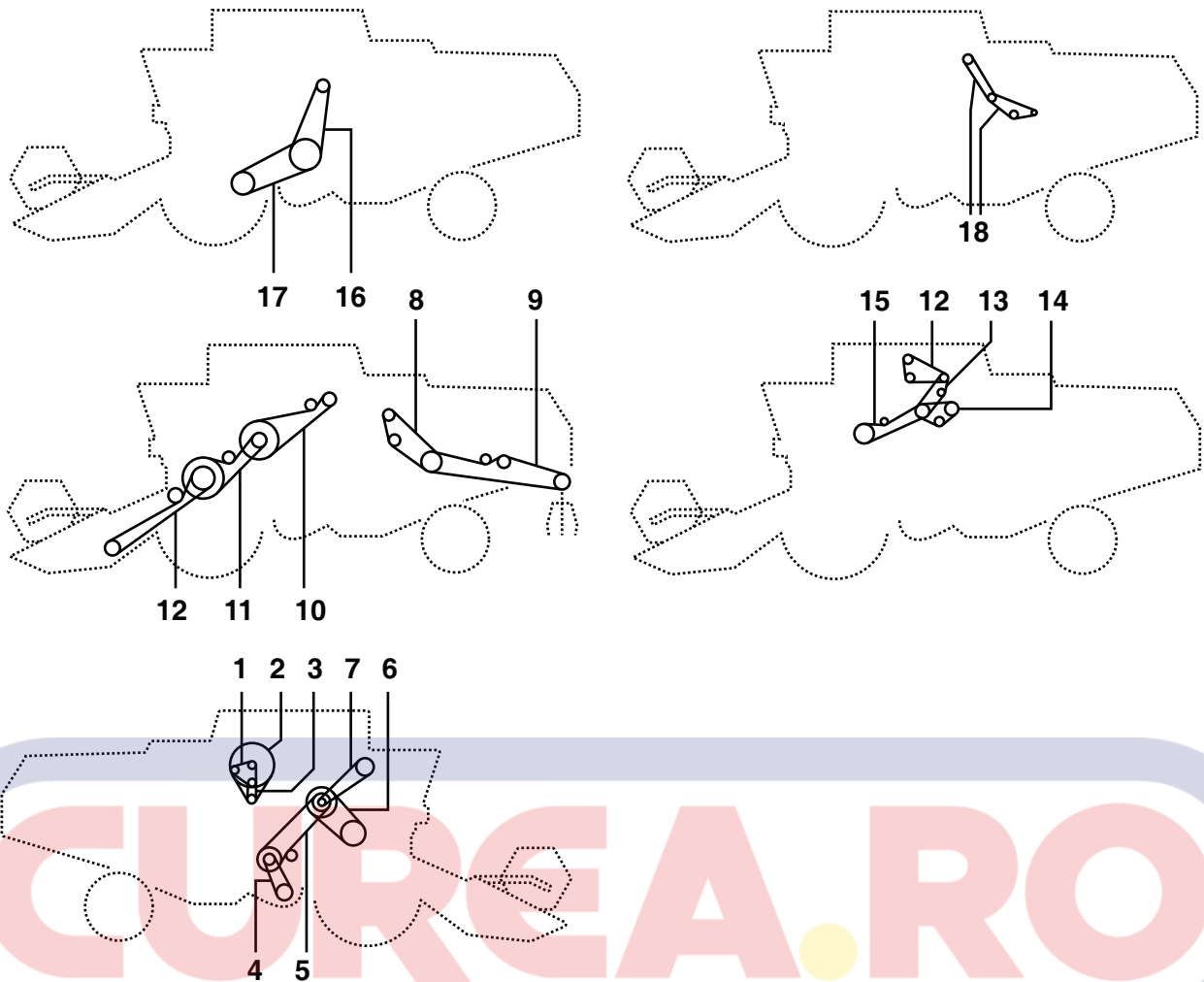

| Belt No. |  | No. of Belts | OEM  Part No. | PIX  Part No. |
|----------|---|--------------|--|--|
| 2 | Rotary Screen Drive | 1 | Z31283 | A-Z31283 |
| 3 | Rotary Screen Drive | 1 | Z32190 | A-Z32190 |
| 4 | Fan Drive Variable Speed | 1 | Z41178 | A-Z41178 |
| 5 | Fan Drive Variable Speed | 1 | Z34405 | A-Z34405 |
| 6 | Cylinder Variator drive | 1 | Z53288 | A-Z53288 |
| 7 | Elevator Drive Unit | 1 | Z20743 | A-Z20743 |
| 8 | - | 1 | Z35965 | A-Z35965 |
| 11 | Straw Walker Drive | 1 | Z33774 | A-Z33774 |
| 12 | - | 1 | Z46222 | A-Z46222 |
| 12 | - | 1 | Z21403 | A-Z21403 |
| 13 | Lead-in Drive | 1 | Z38186 | A-Z38186 |
| 13 | Lead-in Drive | 1 | Z21501 | A-Z21501 |
| 14 | Cutting Table Drive | 1 | Z39312 | A-Z39312 |
| 14 | Cutting Table Drive | 1 | Z39313 | A-Z39313 |
| 21 | Discharge Beater Drive | 1 | Z43253 | A-Z43253 |
| 22 | Hydraulic Pump Drive | 1 | Z42382 | A-Z42382 |

JOHN DEERE 1065 - 1068 HYDRO (...-041200)



| Belt No. |  | No. of Belts | OEM  Part No. | PIX  Part No. |
|----------|---|--------------|--|--|
| 1 | Alternator Belt (following Ser No 623931) | 2 | AR72036 | A-AR72036 |
| 2 | Rotary Screen Drive (following ser. no. 039787) | 1 | Z34786 | A-Z34786 |
| 2 | Rotary Screen Drive (prior to ser. no. 39786) | 1 | Z31283 | A-Z31283 |
| 3 | Countershaft - Purify Drive | 1 | Z32190 | A-Z32190 |
| 4 | Fan Drive Variable Speed | 1 | Z41178 | A-Z41178 |
| 5 | Fan Drive Variable Speed | 1 | Z34405 | A-Z34405 |
| 6 | Cylinder Variator drive (sub For Z20823) | 1 | Z53288 | A-Z53288 |
| 7 | Shaker Shaft drive | 1 | Z35965 | A-Z35965 |
| 8 | Straw Walker Drive | 1 | Z33774 | A-Z33774 |
| 9 | Cutting Table Drive Lead-in | 1 | Z33790 | A-Z33790 |
| 10 | Lead-in Drive | 1 | Z21501 | A-Z21501 |
| 10 | Lead-in Drive | 1 | Z38186 | A-Z38186 |
| 11 | Cutting Table Drive (1068 Hydro) | 1 | Z39312 | A-Z39312 |
| 11 | Cutting Table Drive (1068) | 1 | Z39313 | A-Z39313 |
| 11 | Cutting Table Drive (1068) | 1 | Z39314 | A-Z39314 |
| 12 | Air Conditioning Compressor Drive (sub For Z41889) | 1 | Z42756 | A-Z42756 |
| 13 | Air Conditioning Compressor Drive (prior to ser. no. 033563°) | 1 | Z45482 | A-Z45482 |



JOHN DEERE 1065 - 1068 HYDRO (...-041200)

| Belt No. |  | No. of Belts | OEM  Part No. | PIX  Part No. |
|----------|---|--------------|--|--|
| 13 | Air Conditioning Compressor Drive (following Ser No 033562) | 1 | CA22534 | A-CA22534 |
| 14 | Hydraulic Pump Drive | 1 | Z34828 | A-Z34828 |
| 15 | (sub Forz33368) | 1 | Z47911 | A-Z47911 |
| 16 | Traction (upper) (sub For Az22914) (1065) | 2 | AZ40077 | A-AZ40077 |
| 16 | Traction (upper) (1068 Hydro) | 2 | Z33967 | A-Z33967 |
| 17 | Traction (lower) (1065) | 1 | Z34099 | A-Z34099 |
| 17 | Traction (lower) (1068 Hydro) | 1 | Z33967 | A-Z33967 |
| 18 | Condensor Rotary Blade | 2 | Z43863 | A-Z43863 |



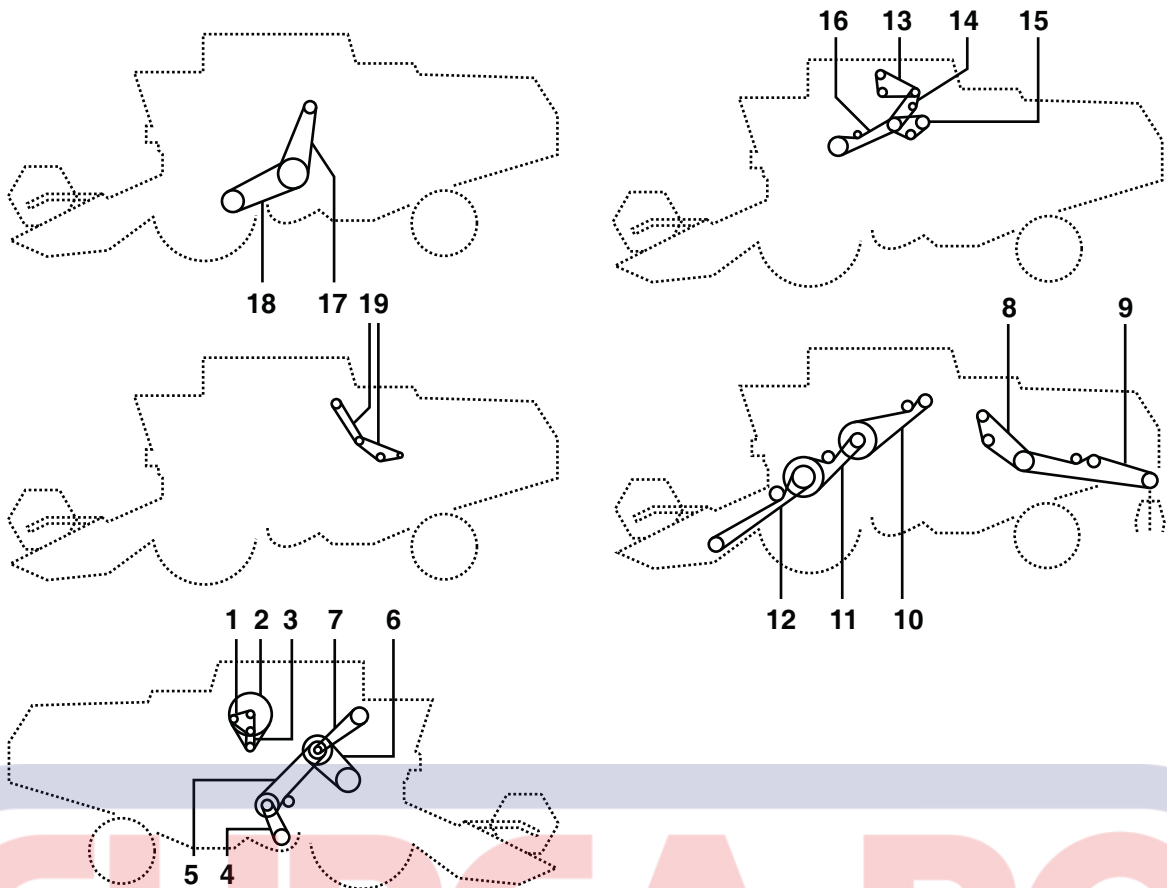



JOHN DEERE 1065 - 1068 HYDRO (041201-...)

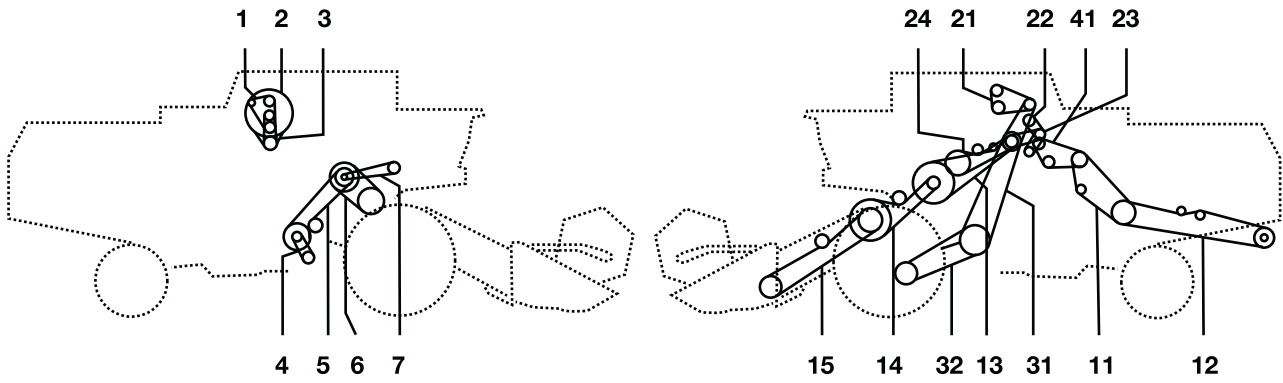

| Belt No. | | No. of Belts | OEM  Part No. | PIX  Part No. |
|----------|---|--------------|--|--|
| 1 | Alternator Belt | 2 | AR72036 | A-AR72036 |
| 2 | Rotary Screen Drive | 1 | Z34786 | A-Z34786 |
| 3 | Countershaft - Purify Drive | 1 | Z32190 | A-Z32190 |
| 4 | Fan Drive Variable Speed | 1 | Z41178 | A-Z41178 |
| 5 | Fan Drive Variable Speed | 1 | Z34405 | A-Z34405 |
| 6 | Cylinder Variator Drive (sub For Z20823) | 1 | Z53288 | A-Z53288 |
| 7 | (prior To Ser Nr 044137) | 1 | Z45026 | A-Z45026 |
| 8 | Shaker Shaft Drive | 1 | Z35965 | A-Z35965 |
| 9 | Straw Walker Drive | 1 | Z33774 | A-Z33774 |
| 10 | Cutting Table Drive Lead-in | 1 | Z33790 | A-Z33790 |
| 11 | Lead-in Drive | 1 | Z21501 | A-Z21501 |
| 11 | Lead-in Drive | 1 | Z38186 | A-Z38186 |
| 12 | Cutting Table Drive (1065 Hydro 4) | 1 | Z39312 | A-Z39312 |
| 12 | Cutting Table Drive (1065) | 1 | Z39313 | A-Z39313 |
| 12 | Cutting Table Drive (1065) | 1 | Z39314 | A-Z39314 |
| 13 | Air Conditioning Compressor Drive | 1 | Z42756 | A-Z42756 |
| 14 | Air Conditioning Compressor Drive | 1 | Z45482 | A-Z45482 |
| 15 | Hydraulic Pump Drive | 1 | Z34828 | A-Z34828 |
| 16 | (sub For Z33368) | 1 | Z47911 | A-Z47911 |
| 17 | Traction (upper) (1068 Hydro) | 2 | Z33967 | A-Z33967 |
| 17 | Traction (upper) (sub For Az22914) (1065) | 2 | AZ40077 | A-AZ40077 |
| 18 | Traction (lower) (1065) | 1 | Z34099 | A-Z34099 |
| 18 | Traction (lower) (1068 Hydro) | 1 | Z33967 | A-Z33967 |
| 19 | Condensor Rotary Blade | 2 | Z43863 | A-Z43863 |



JOHN DEERE 1068



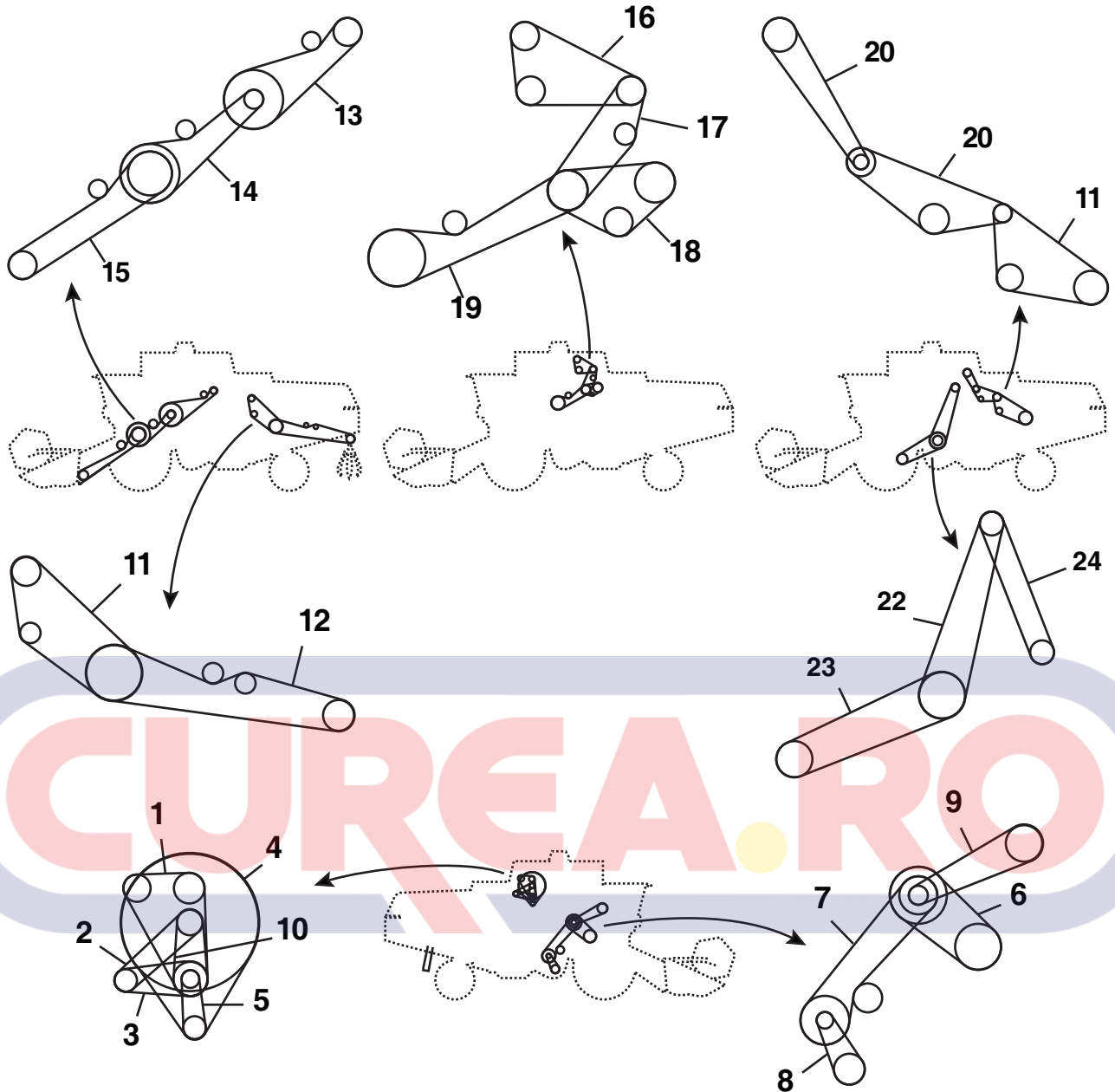

| Belt No. |  | No. of Belts | OEM  Part No. | PIX  Part No. |
|----------|---|--------------|--|--|
| 1 | Fan Drive | 1 | AR72036 | A-AR72036 |
| 2 | Rotary Screen Drive | 1 | Z34786 | A-Z34786 |
| 3 | Rotary Screen Drive | 1 | Z32190 | A-Z32190 |
| 4 | Fan Drive Variable Speed | 1 | Z41178 | A-Z41178 |
| 5 | Fan Drive Variable Speed | 1 | Z34405 | A-Z34405 |
| 6 | Cylinder Variator drive | 1 | Z53288 | A-Z53288 |
| 7 | Tailings Elevator | 1 | Z45026 | A-Z45026 |
| 11 | Shaker Shaft drive | 1 | Z35965 | A-Z35965 |
| 12 | Straw Walker Drive | 1 | Z33774 | A-Z33774 |
| 13 | Cutting Table Drive Lead-in | 1 | Z33790 | A-Z33790 |
| 14 | Lead-in Drive (maize) | 1 | Z38186 | A-Z38186 |
| 14 | Lead-in Drive (grain) | 1 | Z21501 | A-Z21501 |
| 15 | Cutting Table Drive | 1 | Z39312 | A-Z39312 |
| 15 | Cutting Table Drive | 1 | Z39313 | A-Z39313 |
| 15 | Cutting Table Drive | 1 | Z39314 | A-Z39314 |
| 21 | Air Conditioning Compressor Drive Sub. Forz41889 | 1 | Z42756 | A-Z42756 |
| 22 | Air Conditioning Compressor Drive (from Nr. 33563) | 1 | Z45482 | A-Z45482 |
| 23 | Hydraulic Pump Drive | 1 | Z34828 | A-Z34828 |
| 24 | - | 1 | Z47911 | A-Z47911 |
| 32 | Main Drive | 1 | Z34099 | A-Z34099 |
| 41 | Condensor Rotary Blade | 1 | Z43863 | A-Z43863 |

JOHN DEERE 1072 - 1075 - 1075 HYDRO 4



| Belt No. |  | No. of Belts | OEM  Part No. | PIX  Part No. |
|----------|---|--------------|--|--|
| 1 | Fan Drive - 1075 (to Nr 44386) | 1 | AR72036 | A-AR72036 |
| 1 | Fan Drive - 1075 Hydro 4 (to Nr. 44386) | 1 | H79235 | A-H79235 |
| 2 | 1075 Hydro 4 (to Nr. 44386) | 1 | Z38149 | A-Z38149 |
| 3 | 1075 Hydro 4 (to Nr. 44386) | 1 | Z38148 | A-Z38148 |
| 4 | Rotary Screen - 1072-1075 | 1 | Z34786 | A-Z34786 |
| 4 | Rotary Screen - 1075 Hydro 4 (to Nr. 44386) | 1 | Z37192 | A-Z37192 |
| 4 | Rotary Screen 1072 (from Nr. 39787) - 1075-1075 Hydro 4 (from Nr. 44387) | 1 | Z34786 | A-Z34786 |
| 5 | Rotary Screen 1072 - 1075 | 1 | Z32190 | A-Z32190 |
| 5 | Rotary Screen - 1075 Hydro 4 (from Nr. 44387) | 1 | Z45191 | A-Z45191 |
| 5 | Rotary Screen - 1075 Hydro 4 (to Nr. 44386) | 1 | Z37191 | A-Z37191 |

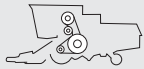

JOHN DEERE 1072 - 1075 - 1075 HYDRO 4

| Belt No. |  | No. of Belts | OEM  Part No. | PIX  Part No. |
|----------|---|--------------|--|--|
| 6 | Cylinder Variator drive (1072) | 1 | Z20823 | A-Z20823 |
| 6 | Cylinder Drive - 1075 + 1075 Hydro 4 | 1 | Z37473 | A-Z37473 |
| 7 | Fan Drive Variable Speed | 1 | Z34405 | A-Z34405 |
| 8 | Fan Drive Variable Speed | 1 | Z41178 | A-Z41178 |
| 9 | Tailings Elevator 5 from Nr. 44137) | 1 | Z45026 | A-Z45026 |
| 10 | 1075 Hydro 4 (from Nr. 44387) | 1 | Z45192 | A-Z45192 |
| 11 | Shaker Shaft drive (to Ser No 430811)(1072) | 1 | Z35965 | A-Z35965 |
| 11 | Shaker Shaft drive (from Ser No 043082) (1072) | 1 | Z38704 | A-Z38704 |
| 12 | Straw Walker Drive | 1 | Z33774 | A-Z33774 |
| 13 | - | 1 | Z33790 | A-Z33790 |
| 14 | Main Drive - 1075/1075 Hydro 4 (maize) | 1 | Z38186 | A-Z38186 |
| 14 | Main Drive (grain) | 1 | Z21501 | A-Z21501 |
| 15 | Cutting Table Drive - 1072 | 1 | Z39313 | A-Z39313 |
| 15 | Cutting Table Drive - 1075/1075 Hydro 4 | 1 | Z39314 | A-Z39314 |
| 16 | Air Conditioning Compressor Drive | 1 | Z42756 | A-Z42756 |
| 17 | Air Conditioning Compressor Drive | 1 | Z45482 | A-Z45482 |
| 18 | Hydraulic Pump Drive | 1 | Z34828 | A-Z34828 |
| 19 | (sub Forz33368) | 1 | Z47911 | A-Z47911 |
| 20 | Condensor Rotary Blade | 2 | Z43863 | A-Z43863 |
| 22 | (1072) | 1 | Z33967 | A-Z33967 |
| 22 | Sub Foraz22914 (1075) | 2 | AZ40077 | A-AZ40077 |
| 23 | (1072) | 1 | Z33967 | A-Z33967 |
| 23 | Main Drive (1075) | 1 | Z34099 | A-Z34099 |
| 24 | Main Drive (1075) | 1 | Z34099 | A-Z34099 |
| 24 | (1075 Hydro 4) | 1 | Z41728 | A-Z41728 |

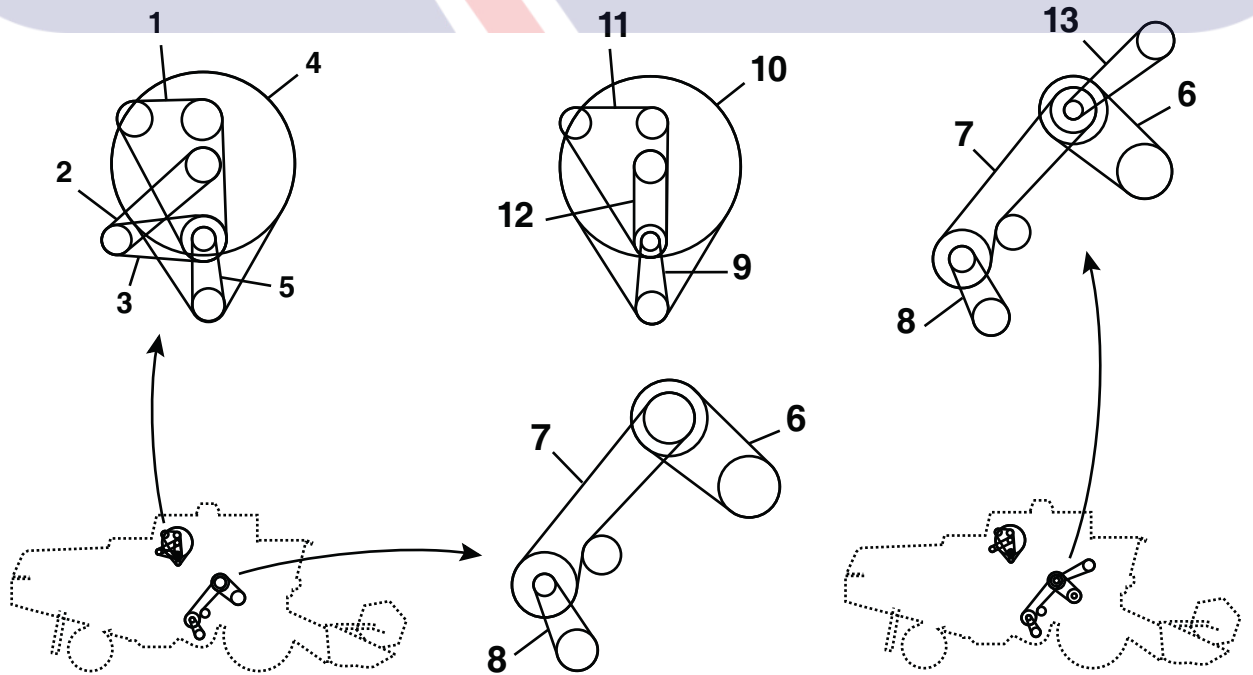
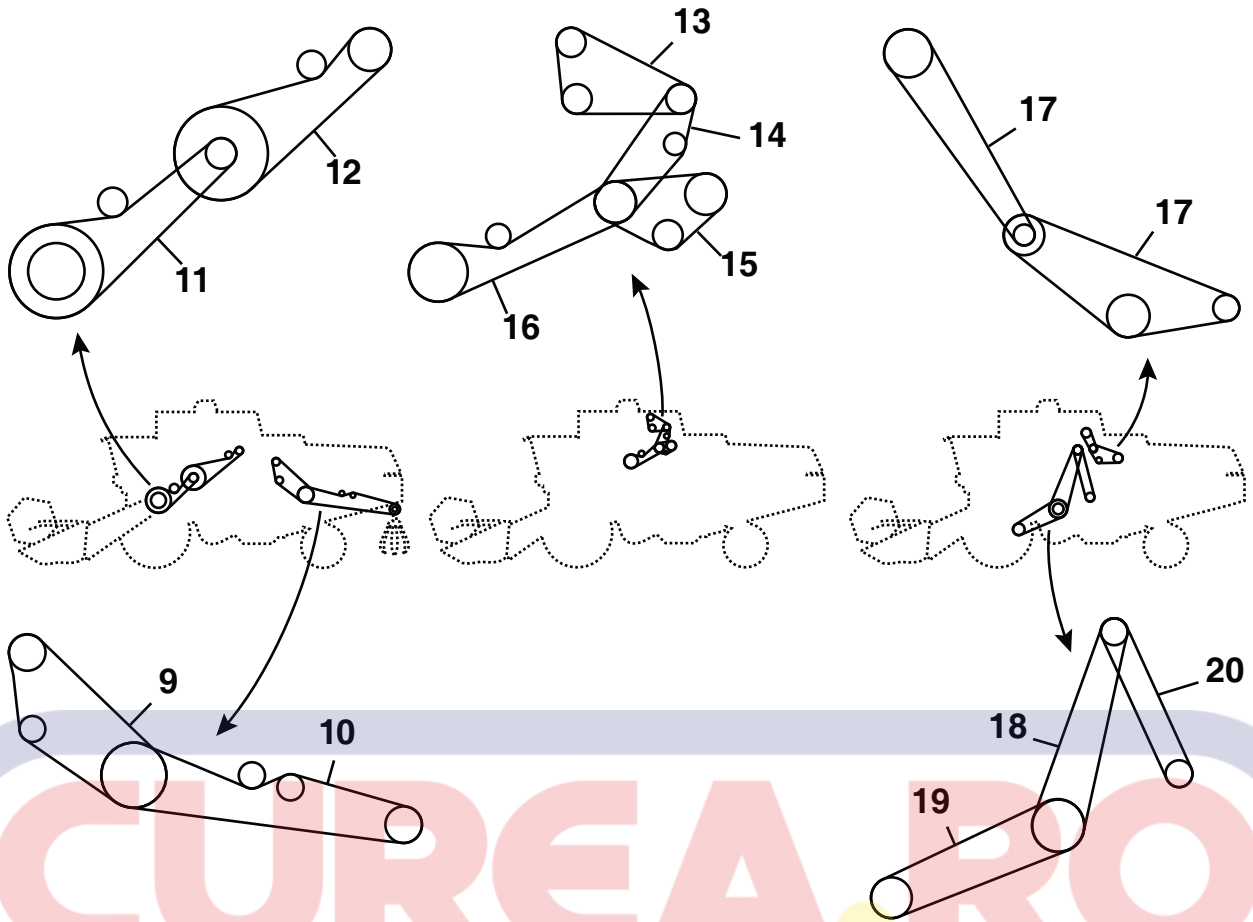
JOHN DEERE 1085 - 1085 HYDRO 4 (... - 041200)





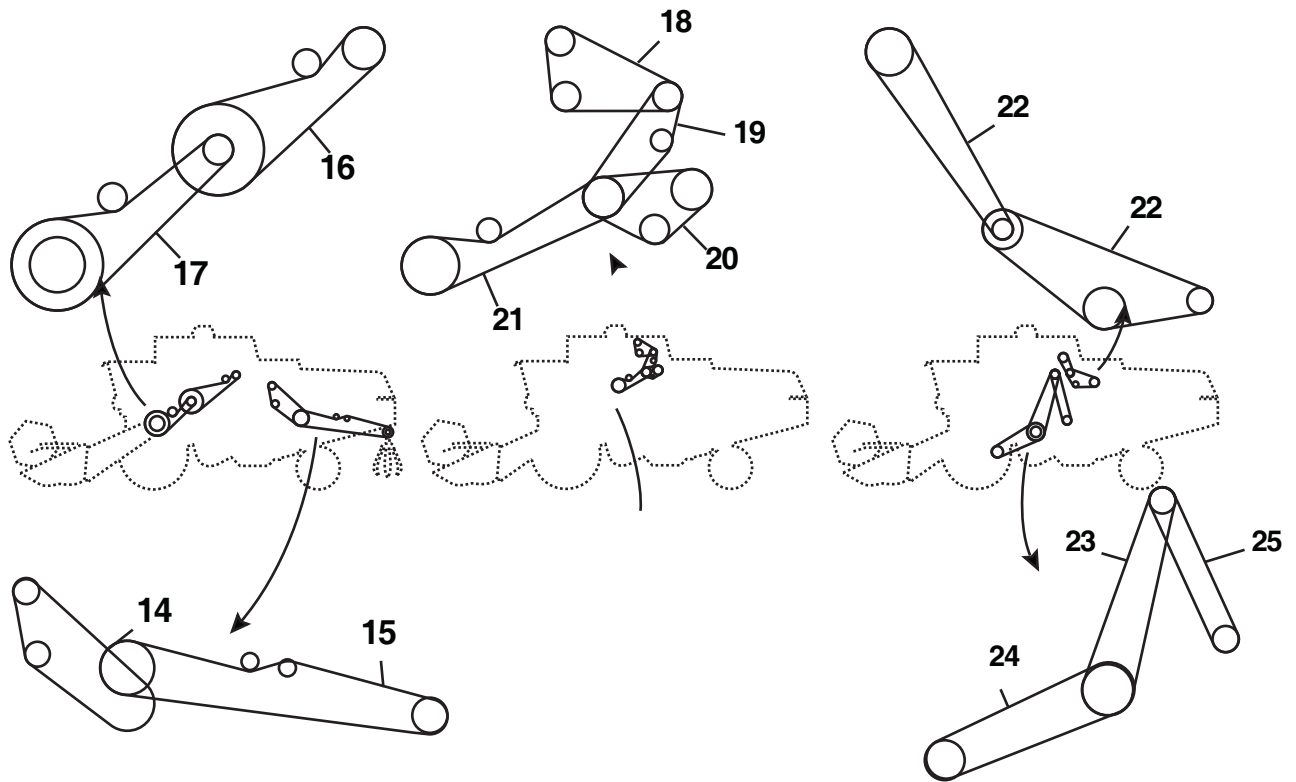

JOHN DEERE 1085 - 1085 HYDRO 4 (... - 041200)

| Belt No. |  | No. of Belts | OEM  Part No. | PIX  Part No. |
|----------|---|--------------|--|--|
| 1 | Fan Drive - 1085 (to Nr. 44387) - 1085 Hydro 4 | 1 | H79236 | A-H79236 |
| 2 | Fan Drive (to Nr. 44386) | 1 | Z38703 | A-Z38703 |
| 3 | Fan Drive (to Nr. 44386) | 1 | Z38702 | A-Z38702 |
| 4 | Rotary Screen - 1085 (to Nr. 44386) - 1085 Hydro 4 | 1 | Z38704 | A-Z38704 |
| 5 | Rotary Screen - 1085 (to Nr. 44386) - 1085 Hydro 4 | 1 | Z38692 | A-Z38692 |
| 6 | Cylinder Variatordrive | 1 | Z37473 | A-Z37473 |
| 7 | Fan Drive Variable Speed | 1 | Z34405 | A-Z34405 |
| 8 | Fan Drive Variable Speed | 1 | Z41178 | A-Z41178 |
| 9 | Shaker Shaft Drive | 1 | Z35965 | A-Z35965 |
| 10 | Straw Walker Drive | 1 | Z33774 | A-Z33774 |
| 11 | Cutting Table Drive Lead-in - 1085 (to Nr. 44386) -1085 Hydro 4 | 1 | Z38697 | A-Z38697 |
| 12 | - | 1 | Z38186 | A-Z38186 |
| 13 | Air Conditioning Compressor Drive | 1 | Z42756 | A-Z42756 |
| 9 | 1085 (from Nr. 44387) | 1 | Z45191 | A-Z45191 |
| 10 | 1085 (from Nr. 44387) | 1 | Z34786 | A-Z34786 |
| 11 | 1085 (from Nr. 44387) | 1 | H79235 | A-H79235 |
| 12 | 1085 (from Nr. 44387) | 1 | Z45192 | A-Z45192 |
| 12 | 1085 Hydro 4 (from Nr. 44387) | 1 | Z45367 | A-Z45367 |
| 13 | Tailings Elevator 5from Nr. 44137) | 1 | Z45026 | A-Z45026 |
| 14 | Air Conditioning Comp. Drive(from Ser Nr. 33563) | 1 | Z42758 | A-Z42758 |
| 14 | Air Conditioning Comp. Drive (till Ser Nr. 33563) | 1 | Z41932 | A-Z41932 |
| 15 | Hydraulic Pump Drive | 1 | Z34828 | A-Z34828 |
| 16 | Unloading Drive | 1 | Z47912 | A-Z47912 |
| 17 | Condensor Rotary Blade | 1 | Z43863 | A-Z43863 |
| 18 | - | 2 | AZ40077 | A-AZ40077 |
| 19 | Main Drive (1085) | 1 | Z34099 | A-Z34099 |
| 20 | Main Drive (1085 Hydro 4) | 1 | Z41563 | A-Z41563 |



JOHN DEERE 1085 - 1085 HYDRO 4 (041201 - ...)







| Belt No. | | No. of Belts | OEM  Part No. | PIX  Part No. |
|----------|---|--------------|---|---|
| 1 | Fan Drive - 1085 (to Nr. 44386) - 1085 Hydro 4 | 1 | H79236 | A-H79236 |
| 2 | Fan Drive (to Nr. 44386) | 1 | Z38703 | A-Z38703 |
| 3 | Fan Drive (to Nr. 44386) | 1 | Z38702 | A-Z38702 |
| 4 | Rotary Screen - 1085 (to Nr. 44386) - 1085 Hydro 4 | 1 | Z38704 | A-Z38704 |
| 5 | Rotary Screen - 1085 (to Nr. 44386) - 1085 Hydro 4 | 1 | Z38692 | A-Z38692 |
| 6 | Cylinder Variator Drive | 1 | Z37473 | A-Z37473 |
| 7 | Fan Drive Variable Speed | 1 | Z34405 | A-Z34405 |
| 8 | Fan Drive Variable Speed | 1 | Z41178 | A-Z41178 |
| 9 | Rotary Screen - 1085 (from Nr. 44387) | 1 | Z45191 | A-Z45191 |
| 10 | Rotary Screen - 1085 (from Nr. 44387) | 1 | Z34786 | A-Z34786 |
| 11 | Fan Drive - 1085 (from Nr. 44387) | 1 | H79235 | A-H79235 |
| 12 | Fan Drive (from Nr. 44387) | 1 | Z45192 | A-Z45192 |
| 12 | Fan Drive (from Nr. 44387) | 1 | Z45367 | A-Z45367 |
| 13 | Tailings Elevator (from Nr. 44137) | 1 | Z45026 | A-Z45026 |
| 14 | Shaker Shaft Drive | 1 | Z35965 | A-Z35965 |
| 15 | Straw Walker Drive | 1 | Z33774 | A-Z33774 |
| 16 | Cutting Table Drive Lead-in - 1085 (to Nr. 44386) | 1 | Z38697 | A-Z38697 |
| 16 | Cutting Table Drive Lead-in - 1085 (from Nr. 44387) | 1 | Z33790 | A-Z33790 |
| 16 | Cutting Table Drive Lead-in - 1085 Hydro 4 | 1 | Z38697 | A-Z38697 |
| 17 | - | 1 | Z43890 | A-Z43890 |
| 18 | Air Conditioning Compressor Drive | 1 | Z42756 | A-Z42756 |
| 19 | - | 1 | Z42758 | A-Z42758 |
| 20 | Hydraulic Pump Drive | 1 | Z34828 | A-Z34828 |
| 21 | Unloading Drive | 1 | Z47912 | A-Z47912 |
| 22 | Condensor Rotary Blade | 1 | Z43863 | A-Z43863 |
| 23 | - | 2 | AZ40077 | A-AZ40077 |
| 24 | Main Drive (1085) | 1 | Z34099 | A-Z34099 |
| 25 | Main Drive (1085 Hydro 4) | 1 | Z41563 | A-Z41563 |

| Belt No. |  | No. of Belts | OEM  Part No. | PIX  Part No. |
|----------|---|--------------|--|--|
| 1 | Unloading Auger | 1 | Z51212 | A-Z51212 |
| 2 | - | 1 | H79236 | A-H79236 |
| 3 | Hydraulic Pump Drive | 1 | Z34828 | A-Z34828 |
| 4 | - | 1 | Z42757 | A-Z42757 |
| 5 | - | 1 | Z33774 | A-Z33774 |
| 6 | - | 1 | Z43888 | A-Z43888 |
| 7 | - | 1 | Z43889 | A-Z43889 |
| 8 | Straw Spreader Drive | 1 | Z32041 | A-Z32041 |
| 9 | - | 1 | Z46709 | A-Z46709 |
| 10 | - | 1 | Z43890 | A-Z43890 |
| 11 | - | 1 | Z46463 | A-Z46463 |
| 12 | Cleaning Fandrive | 1 | Z46365 | A-Z46365 |
| 13 | Cylinder Drive | 1 | Z44936 | A-Z44936 |
| 15 | Air Conditioning Compressor Drive | 1 | Z42756 | A-Z42756 |
| 16 | Condensor Rotary Blade | 1 | Z43863 | A-Z43863 |
| 17 | - | 1 | Z38704 | A-Z38704 |

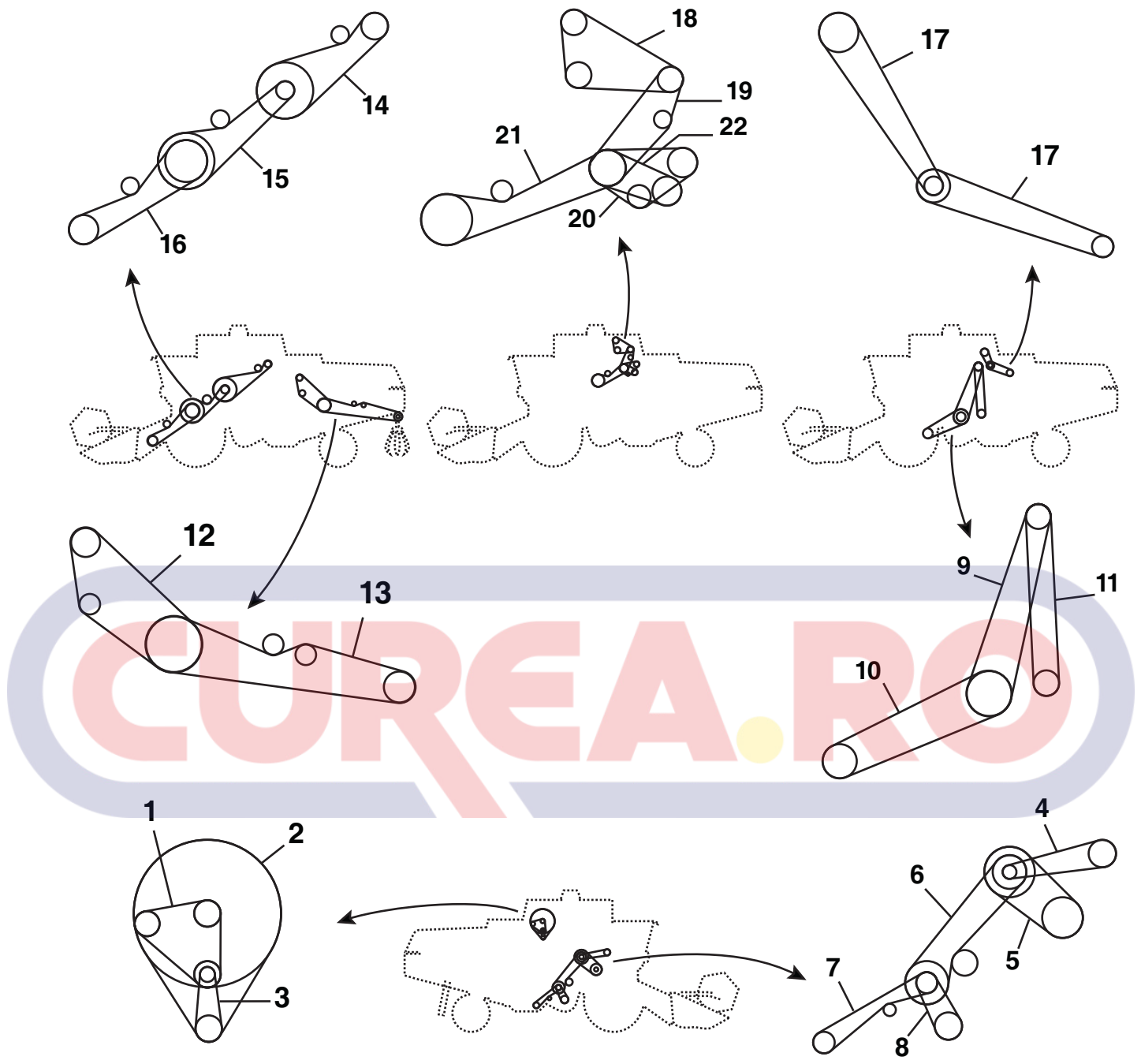

JOHN DEERE 1155 - 1157 - 1158

| Belt No. |  | No. of Belts | OEM  Part No. | PIX  Part No. |
|----------|---|--------------|--|--|
| 1 | 1158 | 1 | AR72036 | A-AR72036 |
| 2 | 1155 - 1157 | 1 | Z31283 | A-Z31283 |
| 2 | 1158 | 1 | Z38704 | A-Z38704 |
| 3 | Rotary Screen Drive | 1 | Z32190 | A-Z32190 |
| 4 | - | 1 | Z20459 | A-Z20459 |
| 5 | - | 1 | Z34405 | A-Z34405 |
| 6 | Cylinder Variatordrive | 1 | Z53288 | A-Z53288 |
| 7 | - | 1 | Z20743 | A-Z20743 |
| 8 | Shaker Shaftdrive | 1 | Z35965 | A-Z35965 |
| 9 | - | 1 | Z33774 | A-Z33774 |
| 10 | - | 1 | Z46222 | A-Z46222 |
| 11 | Lead-in Drive | 1 | Z21501 | A-Z21501 |
| 12 | Cutting Table Drive | 1 | Z39313 | A-Z39313 |
| 12 | - | 1 | Z39312 | A-Z39312 |
| 13 | - | 2 | Z34121 | A-Z34121 |
| 14 | - | 1 | Z43253 | A-Z43253 |
| 15 | - | 1 | Z42382 | A-Z42382 |



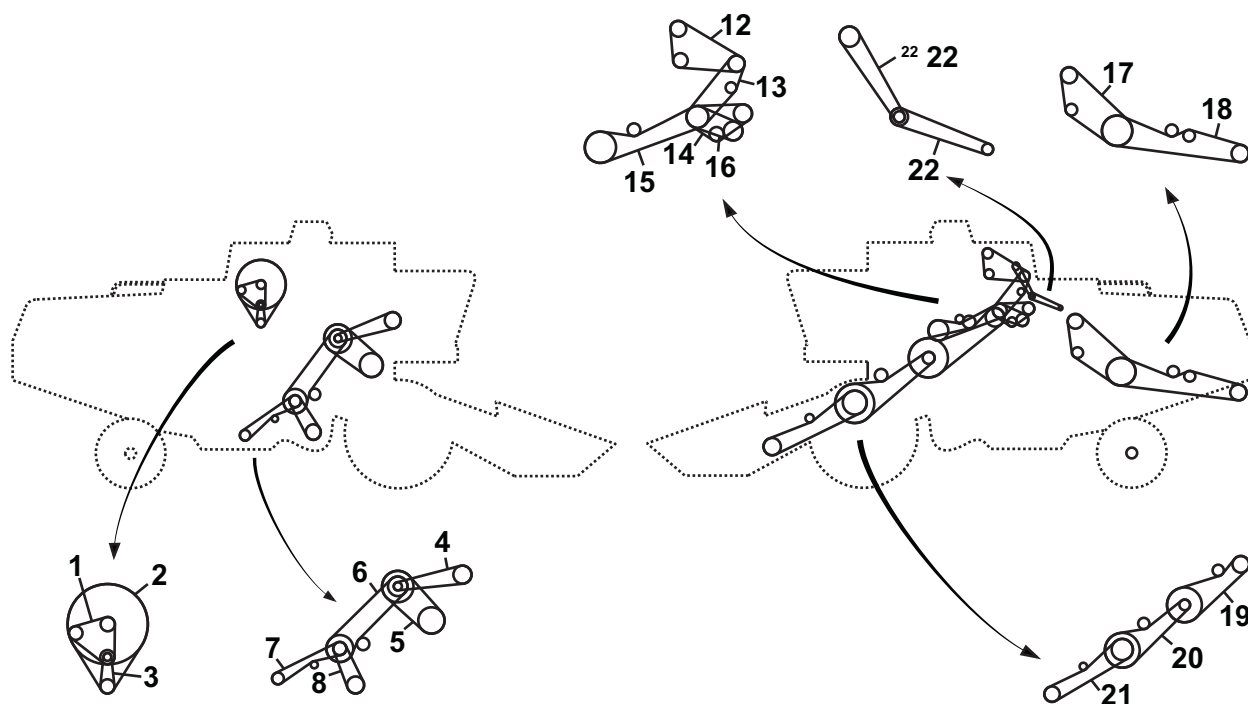

| Belt No. |  | No. of Belts | OEM  Part No. | PIX  Part No. |
|----------|---|--------------|--|--|
| 1 | Alternator Belt | 1 | AR72036 | A-AR72036 |
| 2 | 1166 | 1 | Z46764 | A-Z46764 |
| 2 | Rotary Screen (1166 Hydro 4) | 1 | Z34786 | A-Z34786 |
| 3 | Rotary Screen Drive | 1 | Z32190 | A-Z32190 |
| 4 | Tailings Elevator | 1 | Z45026 | A-Z45026 |
| 5 | Cylinder Variator drive | 1 | Z53288 | A-Z53288 |
| 5 | Cylinder Drive | 1 | Z44936 | A-Z44936 |
| 6 | Separator Drive | 1 | Z46366 | A-Z46366 |
| 7 | Unloading Drive | 1 | Z47912 | A-Z47912 |
| 8 | Cleaning Fandrive | 1 | Z46365 | A-Z46365 |
| 9 | 1166 - For Posi-torque Ground Speed Drive | 2 | AZ37807 | A-AZ37807 |
| 10 | Main Drive (1166) | 1 | Z34099 | A-Z34099 |
| 11 | 1166 Hydro 4 | 1 | Z53290 | A-Z53290 |
| 12 | Shaker Shaft drive | 1 | Z35965 | A-Z35965 |
| 13 | Straw Spreader Drive | 1 | Z32041 | A-Z32041 |
| 14 | - | 1 | Z33790 | A-Z33790 |
| 15 | - | 1 | Z38186 | A-Z38186 |
| 15 | Lead-in Drive | 1 | Z21501 | A-Z21501 |
| 16 | Cutting Table Drive | 1 | Z39313 | A-Z39313 |
| 16 | With Long Feeder House | 1 | Z39314 | A-Z39314 |
| 17 | Condensor Rotary Blade (1166) | 2 | Z43863 | A-Z43863 |
| 18 | Air Conditioning Compressor Drive With Separate Condenser cooling (1166) | 1 | Z42756 | A-Z42756 |
| 19 | Air Conditioning Compressor Drive (1166) | 1 | Z45482 | A-Z45482 |
| 20 | Hydraulic Pump Drive | 1 | Z34828 | A-Z34828 |
| 21 | Unloading Auger | 1 | Z51212 | A-Z51212 |
| 22 | Air Conditioning Compressor Drive | 1 | Z46759 | A-Z46759 |



| Belt No. | | No. of Belts | OEM  Part No. | PIX  Part No. |
|----------|--|--------------|---|---|
| 1 | Alternator Belt | 1 | AR72036 | A-AR72036 |
| 2 | - | 1 | Z46764 | A-Z46764 |
| 2 | - | 1 | Z34786 | A-Z34786 |
| 3 | Rotary Screen Drive | 1 | Z32190 | A-Z32190 |
| 4 | Tailings Elevator | 1 | Z45026 | A-Z45026 |
| 5 | Cylinder Variator Drive (sub For Z20823) | 1 | Z53288 | A-Z53288 |
| 6 | Separator Drive | 1 | Z46366 | A-Z46366 |
| 7 | Unloading Drive | 1 | Z47912 | A-Z47912 |
| 8 | Cleaning Fan Drive | 1 | Z46365 | A-Z46365 |
| 11 | 1169 Hydro 4 | 1 | Z53290 | A-Z53290 |
| 12 | Air Conditioning Compressor Drive With Separate Condenser Cooling (1169) | 1 | Z42756 | A-Z42756 |
| 13 | Air Conditioning Compressor Drive (1169) | 1 | Z45482 | A-Z45482 |
| 14 | Hydraulic Pump Drive | 1 | Z34828 | A-Z34828 |
| 15 | Unloading Auger | 1 | Z51212 | A-Z51212 |
| 16 | Air Conditioning Compressor Drive | 1 | Z46759 | A-Z46759 |
| 17 | Shaker Shaft Drive | 1 | Z35965 | A-Z35965 |
| 18 | Straw Spreader Drive | 1 | Z32041 | A-Z32041 |
| 19 | - | 1 | Z33790 | A-Z33790 |
| 20 | Lead-in Drive (grain) | 1 | Z38186 | A-Z38186 |
| 20 | Lead-in Drive (maize) | 1 | Z21501 | A-Z21501 |
| 21 | - | 1 | Z39312 | A-Z39312 |
| 22 | Condensor Rotary Blade | 1 | Z43863 | A-Z43863 |

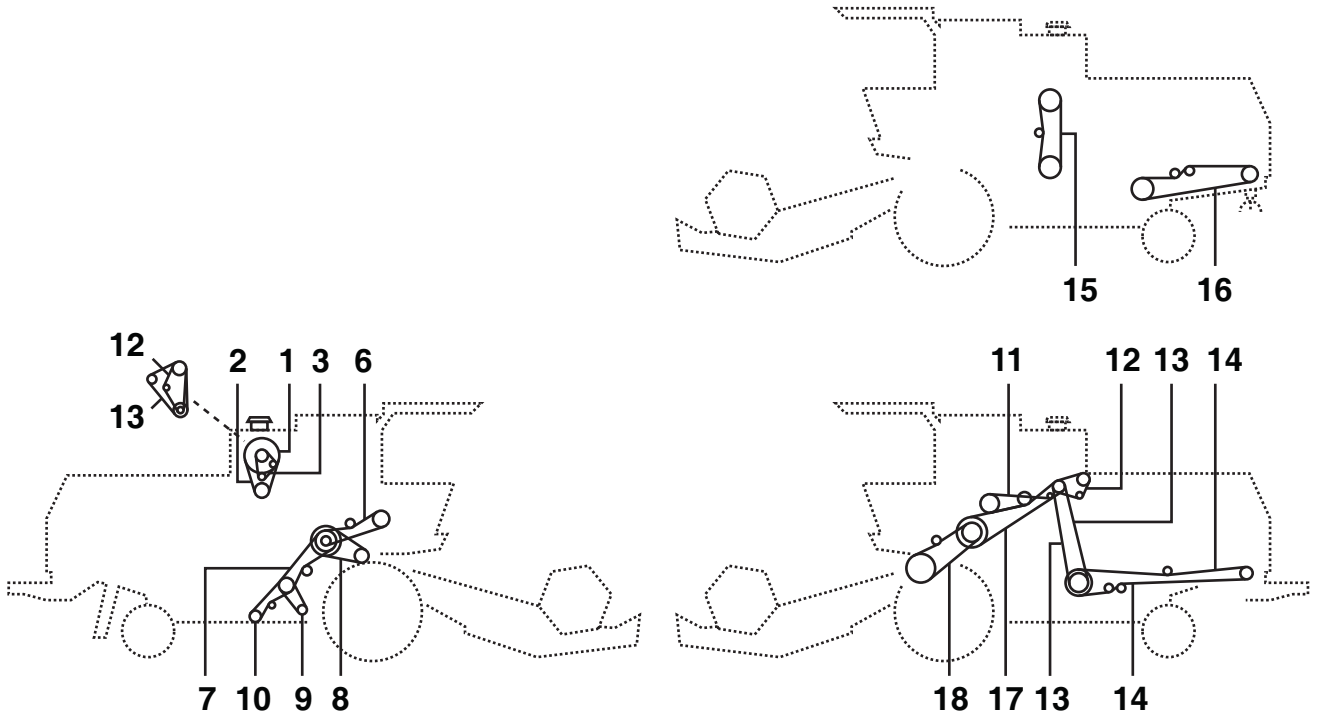

JOHN DEERE 1170



| Belt No. | | No. of Belts | OEM  Part No. | PIX  Part No. |
|----------|--------------------|--------------|---|---|
| 1 | - | 1 | CQ03265 | A-CQ03265 |
| 2 | - | 1 | CQ17755 | A-CQ17755 |
| 3 | - | 1 | CQ34345 | A-CQ34345 |
| 4 | - | 1 | CQ28344 | A-CQ28344 |
| 5 | - | 1 | Z46709 | A-Z46709 |
| 6 | - | 1 | CQ03478 | A-CQ03478 |
| 7 | - | 1 | Z46463 | A-Z46463 |
| 8 | - | 1 | Z43890 | A-Z43890 |
| 9 | - | 1 | CQ08239 | A-CQ08239 |
| 11 | - | 1 | S17044 | A-S17044 |
| 12 | - | 1 | CQ03492 | A-CQ03492 |
| 13 | - | 1 | R123451 | A-R123451 |
| 14 | Tailings Elevator | 1 | Z45026 | A-Z45026 |
| 15 | - | 1 | SA00601 | A-SA00601 |
| 16 | Cylinder Drive | 1 | Z44936 | A-Z44936 |
| 17 | - | 1 | Z41178 | A-Z41178 |
| 18 | Ser Nr Till083094 | 1 | CQ13837 | A-CQ13837 |
| 18 | Ser Nr From 038095 | 1 | CQ31965 | A-CQ31965 |

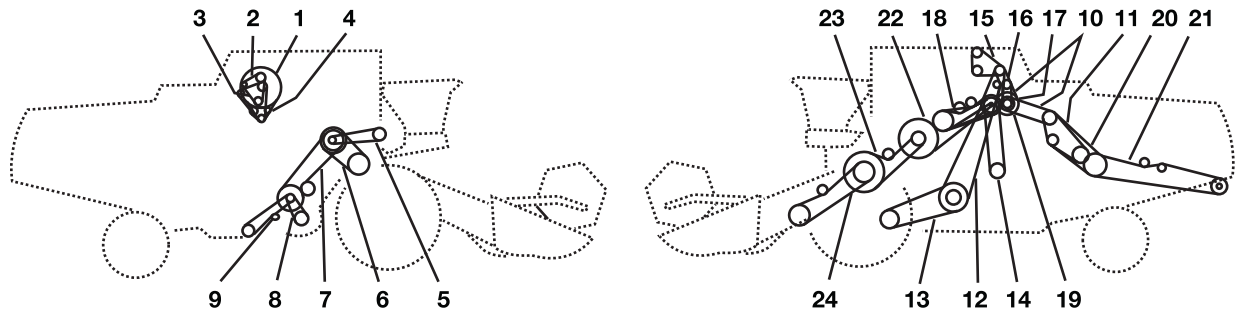

JOHN DEERE 1174 - 1174 HYDRO 4



| Belt No. |  | No. of Belts | OEM  Part No. | PIX  Part No. |
|----------|---|--------------|--|--|
| 1 | 1174 Only - Ac With Integrated Condenser Cooling | 1 | Z46764 | A-Z46764 |
| 1 | Air Conditioning With Separate Condenser Cooling | 1 | Z38704 | A-Z38704 |
| 2 | Alternator Belt | 1 | AR72036 | A-AR72036 |
| 3 | 1174 Hydro 4 Only | 1 | Z45367 | A-Z45367 |
| 4 | - | 1 | Z32190 | A-Z32190 |
| 4 | - | 1 | Z38692 | A-Z38692 |
| 5 | Tailings Elevator | 1 | Z45026 | A-Z45026 |
| 6 | - | 1 | Z20823 | A-Z20823 |
| 6 | Cylinder Variator Drive (sub For Z20823) | 1 | Z53288 | A-Z53288 |
| 6 | Cylinder Drive | 1 | Z44936 | A-Z44936 |
| 7 | Separator Drive | 1 | Z46366 | A-Z46366 |
| 8 | Cleaning Fan Drive | 1 | Z46365 | A-Z46365 |
| 9 | Unloading Drive | 1 | Z47912 | A-Z47912 |
| 10 | Condensor Rotary Blade | 1 | Z43863 | A-Z43863 |
| 11 | - | 1 | Z38704 | A-Z38704 |
| 12 | 1174 - For Posi-torque Ground Speed Drive | 2 | AZ37807 | A-AZ37807 |
| 13 | 1174 - For Posi-torque Ground Speed Drive | 1 | Z34099 | A-Z34099 |
| 14 | 1174 Hydro 4 Only | 1 | Z41728 | A-Z41728 |
| 15 | Air Conditioning With Separate Condenser Cooling | 1 | Z42756 | A-Z42756 |
| 16 | Air Conditioning Compressor Drive | 1 | Z45482 | A-Z45482 |
| 17 | Hydraulic Pump Drive | 1 | Z34828 | A-Z34828 |
| 18 | Unloading Auger | 1 | Z51212 | A-Z51212 |
| 19 | Air Conditioning with Integrated Condenser Cooling | 1 | Z46759 | A-Z46759 |
| 20 | Shaker Shaft Drive | 1 | Z35965 | A-Z35965 |
| 21 | Straw Spreader Drive | 1 | Z32041 | A-Z32041 |
| 22 | - | 1 | Z33790 | A-Z33790 |
| 23 | - | 1 | Z38186 | A-Z38186 |
| 23 | Lead-in Drive | 1 | Z21501 | A-Z21501 |
| 24 | Cutting Table Drive | 1 | Z39313 | A-Z39313 |
| 24 | For Feeder Conveyor Long | 1 | Z39314 | A-Z39314 |

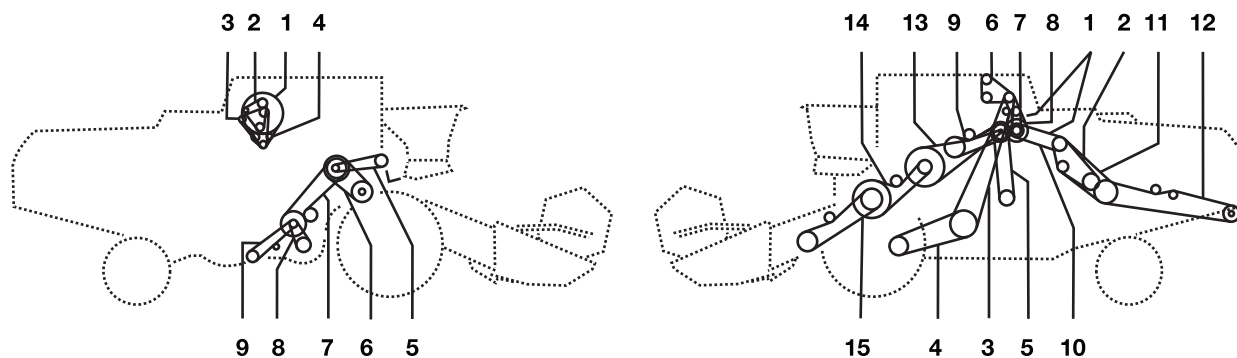

JOHN DEERE 1177 - 1177 HYDRO 4



| Belt No. |  | No. of Belts | OEM  Part No. | PIX  Part No. |
|----------|---|--------------|--|--|
| 1 | 1177 Only- Ac With Integrated Condenser Cooling | 1 | Z46764 | A-Z46764 |
| 2 | - | 1 | H79236 | A-H79236 |
| 2 | 1177 Only | 1 | AR72036 | A-AR72036 |
| 3 | - | 1 | Z45367 | A-Z45367 |
| 4 | - | 1 | Z38692 | A-Z38692 |
| 5 | Tailings Elevator | 1 | Z45026 | A-Z45026 |
| 6 | Cylinder Drive | 1 | Z44936 | A-Z44936 |
| 7 | Separator Drive | 1 | Z46366 | A-Z46366 |
| 8 | Cleaning Fandrive | 1 | Z46365 | A-Z46365 |
| 9 | Unloading Drive | 1 | Z47912 | A-Z47912 |
| 10 | Shaker Shaftdrive | 1 | Z35965 | A-Z35965 |
| 11 | Straw Spreader Drive | 1 | Z32041 | A-Z32041 |
| 12 | 1177 Only | 1 | Z33790 | A-Z33790 |
| 12 | 1174 Hydro 4 Only | 1 | Z58697 | A-Z58697 |
| 13 | - | 1 | Z38186 | A-Z38186 |
| 14 | - | 1 | Z39314 | A-Z39314 |
| 15 | Air Conditioning With Separate Condensercooling | 1 | Z42756 | A-Z42756 |
| 16 | 1177 Hydro 4 | 1 | Z42757 | A-Z42757 |
| 16 | Air Conditioning Compressor Drive (1177) | 1 | Z45482 | A-Z45482 |
| 17 | Hydraulic Pump Drive | 1 | Z34828 | A-Z34828 |
| 18 | Unloading Auger | 1 | Z51212 | A-Z51212 |
| 19 | 1177 Only- Ac With Integrated Condenser Cooling | 1 | Z46759 | A-Z46759 |
| 20 | 1177 - For Posi-torque Ground Speed Drive | 2 | AZ37807 | A-AZ37807 |
| 21 | Main Drive (1177) | 1 | Z34099 | A-Z34099 |
| 22 | 1177 Hydro 4 | 1 | Z46709 | A-Z46709 |
| 23 | Condensor Rotary Blade | 1 | Z43863 | A-Z43863 |
| 24 | Without Croos Shaker | 1 | Z38704 | A-Z38704 |

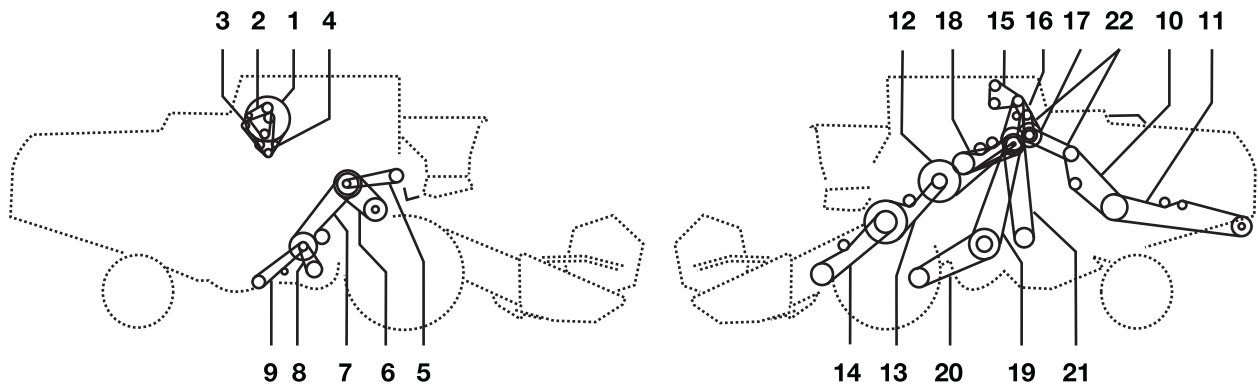

JOHN DEERE 1188 - 1188 HYDRO 4



| Belt No. |  | No. of Belts | OEM  Part No. | PIX  Part No. |
|----------|---|--------------|--|--|
| 0 | - | 1 | Z51707 | A-Z51707 |
| 1 | - | 1 | Z38704 | A-Z38704 |
| 2 | - | 1 | H79236 | A-H79236 |
| 3 | - | 1 | Z45367 | A-Z45367 |
| 4 | - | 1 | Z38692 | A-Z38692 |
| 5 | Tailings Elevator | 1 | Z45026 | A-Z45026 |
| 6 | Cylinder Drive | 1 | Z44936 | A-Z44936 |
| 7 | Separator Drive | 1 | Z46366 | A-Z46366 |
| 8 | Cleaning Fan Drive | 1 | Z46365 | A-Z46365 |
| 9 | Unloading Drive | 1 | Z47912 | A-Z47912 |
| 10 | Shaker Shaft Drive | 1 | Z35965 | A-Z35965 |
| 11 | Straw Spreader Drive | 1 | Z32041 | A-Z32041 |
| 12 | - | 1 | Z46463 | A-Z46463 |
| 13 | - | 1 | Z43890 | A-Z43890 |
| 14 | - | 1 | Z43888 | A-Z43888 |
| 14 | For Feeder Conveyor Long | 1 | Z43889 | A-Z43889 |
| 15 | Air Conditioning With Separate condenser Cooling | 1 | Z42756 | A-Z42756 |
| 17 | Hydraulic Pump Drive | 1 | Z34828 | A-Z34828 |
| 18 | Unloading Auger | 1 | Z51212 | A-Z51212 |
| 20 | Main Drive (1188) | 1 | Z34099 | A-Z34099 |
| 22 | Condensor Rotary Blade | 1 | Z43863 | A-Z43863 |

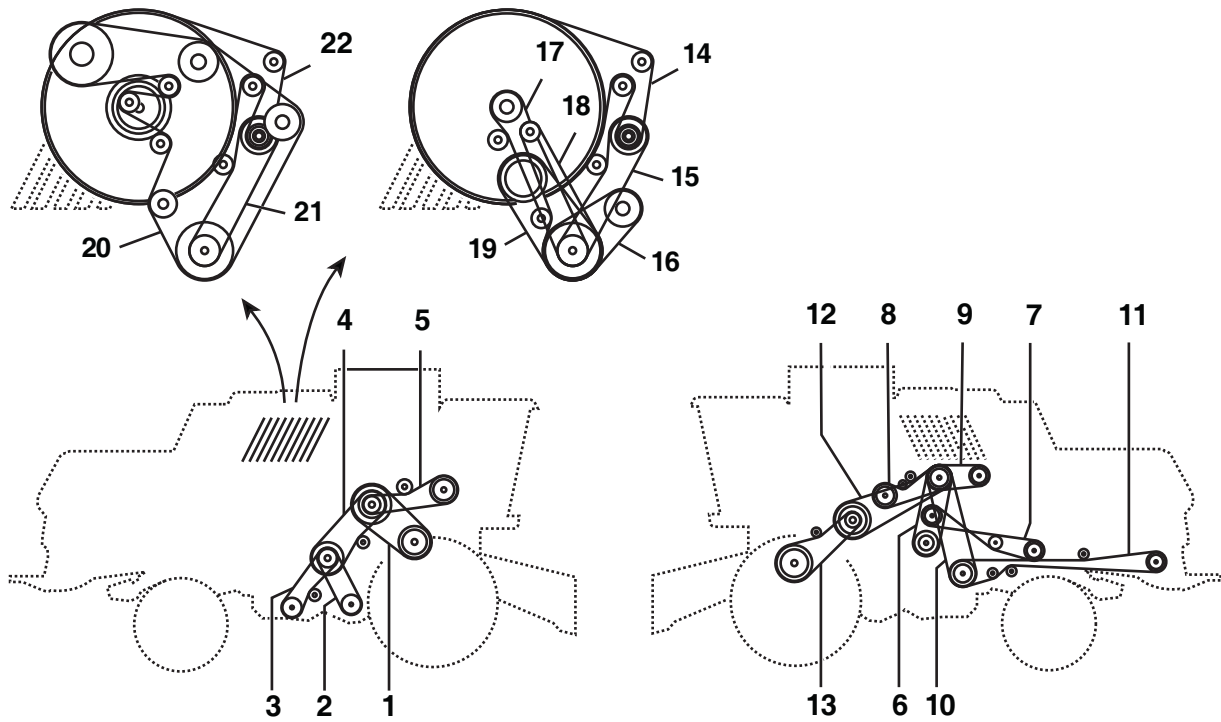

JOHN DEERE 1450 CWS /WTS - 1550 CWS/WTS



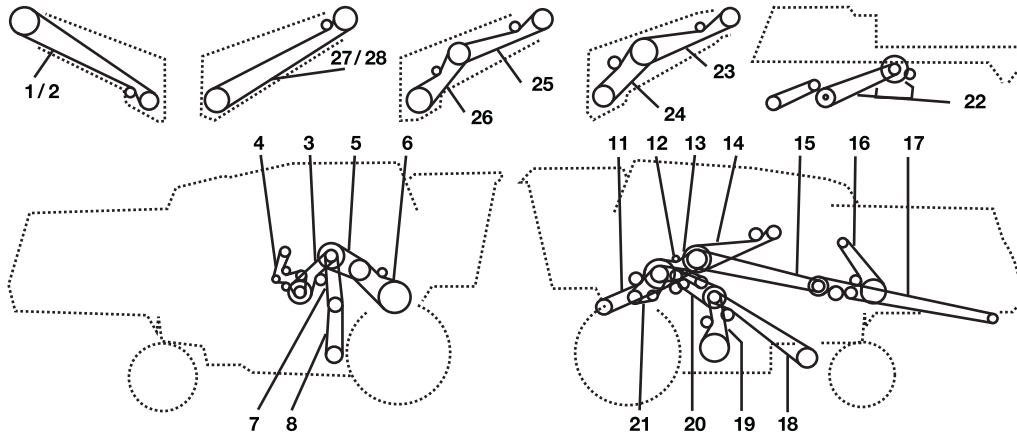

| Belt No. | | No. of Belts | OEM  Part No. | PIX  Part No. |
|----------|-------------------|--------------|--|--|
| 1 | CYLINDER DRIVE | 1 | Z44936 | A-Z44936 |
| 2 | - | 1 | Z41178 | A-Z41178 |
| 3 | - | 1 | CQ31965 | A-CQ31965 |
| 4 | - | 1 | SA00601 | A-SA00601 |
| 5 | TAILINGS ELEVATOR | 1 | Z45026 | A-Z45026 |
| 6 | WTS series | 1 | Z46709 | A-Z46709 |
| 7 | WTS series | 1 | CQ42150 | A-CQ42150 |
| 8 | - | 1 | CQ03265 | A-CQ03265 |
| 9 | - | 1 | CQ17755 | A-CQ17755 |
| 10 | - | 1 | CQ35426 | A-CQ35426 |
| 11 | - | 1 | CQ39824 | A-CQ39824 |
| 12 | - | 1 | Z46463 | A-Z46463 |
| 13 | - | 1 | Z43890 | A-Z43890 |
| 15 | - | 1 | CQ37755 | A-CQ37755 |
| 16 | - | 1 | M82461 | A-M82461 |
| 17 | - | 1 | CQ40222 | A-CQ40222 |
| 18 | - | 1 | CQ42066 | A-CQ42066 |
| 19 | - | 1 | M45862 | A-M45862 |
| 20 | (SUB CQ65230) | 1 | CQ71839 | A-CQ71839 |
| 20 | (SUB CQ68171) | 1 | CQ71838 | A-CQ71838 |
| 22 | - | 1 | CQ61084 | A-CQ61084 |

JOHN DEERE 2054 - 2056 - 2058





| Belt No. |  | No. of Belts | OEM  Part No. | PIX  Part No. |
|----------|---|--------------|--|--|
| 1 | - | 1 | Z54406 | A-Z54406 |
| 1 | - | 1 | Z55801 | A-Z55801 |
| 1 | - | 1 | Z61151 | A-Z61151 |
| 2 | - | 1 | Z58752 | A-Z58752 |
| 2 | - | 1 | Z59419 | A-Z59419 |
| 3 | - | 1 | Z59556 | A-Z59556 |
| 3 | - | 1 | Z63005 | A-Z63005 |
| 4 | - | 1 | Z59557 | A-Z59557 |
| 5 | CYLINDER DRIVE | 1 | Z44936 | A-Z44936 |
| 6 | - | 1 | Z61858 | A-Z61858 |
| 7 | - | 1 | Z62110 | A-Z62110 |
| 8 | - | 1 | Z62111 | A-Z62111 |
| 11 | - | 1 | Z59344 | A-Z59344 |
| 12 | - | 1 | Z57084 | A-Z57084 |
| 13 | - | 1 | Z64912 | A-Z64912 |
| 13 | - | 1 | Z61150 | A-Z61150 |
| 13 | - | 1 | Z52909 | A-Z52909 |
| 14 | - | 1 | Z61857 | A-Z61857 |
| 15 | - | 1 | Z59286 | A-Z59286 |
| 16 | - | 1 | Z59114 | A-Z59114 |
| 17 | - | 1 | Z59342 | A-Z59342 |
| 18 | - | 1 | Z60135 | A-Z60135 |
| 19 | - | 1 | Z59322 | A-Z59322 |
| 20 | - | 1 | Z56959 | A-Z56959 |
| 21 | - | 1 | Z56421 | A-Z56421 |
| 22 | - | 1 | Z48212 | A-Z48212 |
| 23 | - | 1 | Z61152 | A-Z61152 |
| 23 | - | 1 | Z60931 | A-Z60931 |
| 24 | - | 1 | Z61154 | A-Z61154 |
| 24 | - | 1 | Z62211 | A-Z62211 |
| 25 | - | 1 | Z61152 | A-Z61152 |
| 25 | - | 1 | Z60931 | A-Z60931 |
| 25 | - | 1 | Z54807 | A-Z54807 |
| 25 | - | 1 | Z58751 | A-Z58751 |
| 26 | - | 1 | Z61153 | A-Z61153 |
| 26 | - | 1 | Z61827 | A-Z61827 |



| Belt No. |  | No. of Belts | OEM  Part No. | PIX  Part No. |
|----------|---|--------------|--|--|
| 26 | - | 1 | Z62213 | A-Z62213 |
| 26 | - | 1 | Z55459 | A-Z55459 |
| 27 | - | 1 | Z61164 | A-Z61164 |
| 27 | - | 1 | Z62551 | A-Z62551 |
| 27 | - | 1 | Z54406 | A-Z54406 |
| 27 | - | 1 | Z62214 | A-Z62214 |
| 28 | - | 1 | Z60930 | A-Z60930 |
| 28 | - | 1 | Z62552 | A-Z62552 |

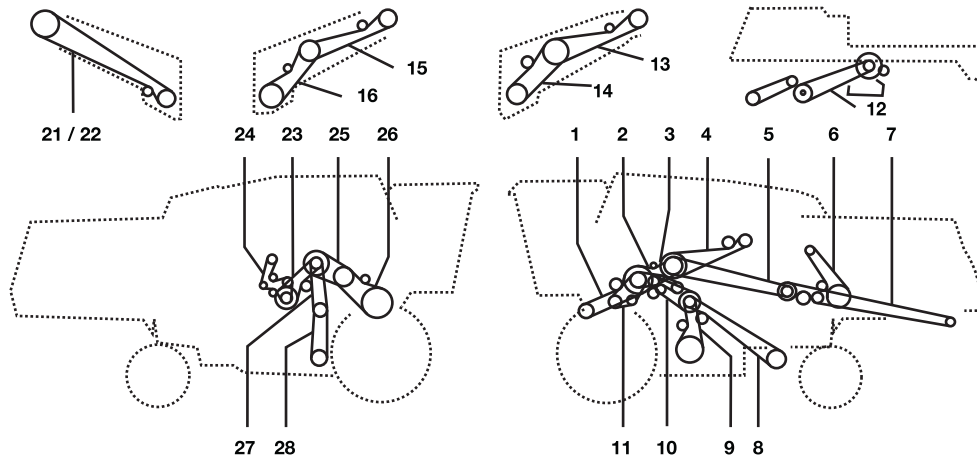

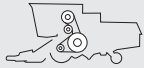
JOHN DEERE 2064 - 2066



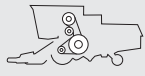



| Belt No. |  | No. of Belts | OEM  Part No. | PIX  Part No. |
|----------|---|--------------|--|--|
| 1 | - | 1 | Z59344 | A-Z59344 |
| 1 | - | 1 | Z61151 | A-Z61151 |
| 2 | - | 1 | Z57084 | A-Z57084 |
| 3 | - | 1 | Z64912 | A-Z64912 |
| 3 | - | 1 | Z61150 | A-Z61150 |
| 3 | - | 1 | Z52909 | A-Z52909 |
| 4 | - | 1 | Z61857 | A-Z61857 |
| 5 | - | 1 | Z59286 | A-Z59286 |
| 6 | - | 1 | Z59114 | A-Z59114 |
| 7 | - | 1 | Z59342 | A-Z59342 |
| 8 | - | 1 | Z60135 | A-Z60135 |
| 9 | - | 1 | Z56421 | A-Z56421 |
| 10 | - | 1 | Z56959 | A-Z56959 |
| 11 | - | 1 | Z59322 | A-Z59322 |
| 12 | - | 1 | Z48212 | A-Z48212 |
| 12 | - | 1 | Z59419 | A-Z59419 |
| 13 | - | 1 | Z61152 | A-Z61152 |
| 13 | - | 1 | Z60931 | A-Z60931 |
| 14 | - | 1 | Z61154 | A-Z61154 |
| 14 | - | 1 | Z62211 | A-Z62211 |
| 15 | - | 1 | Z61152 | A-Z61152 |
| 15 | - | 1 | Z60931 | A-Z60931 |
| 15 | - | 1 | Z54807 | A-Z54807 |
| 15 | - | 1 | Z58751 | A-Z58751 |
| 16 | - | 1 | Z61153 | A-Z61153 |
| 16 | - | 1 | Z61827 | A-Z61827 |
| 16 | - | 1 | Z62213 | A-Z62213 |
| 16 | - | 1 | Z55459 | A-Z55459 |
| 21 | - | 1 | Z55801 | A-Z55801 |
| 21 | - | 1 | Z54406 | A-Z54406 |
| 22 | - | 1 | Z58752 | A-Z58752 |
| 22 | - | 1 | Z59419 | A-Z59419 |
| 23 | - | 1 | Z59556 | A-Z59556 |
| 23 | - | 1 | Z63005 | A-Z63005 |
| 24 | - | 1 | Z59557 | A-Z59557 |
| 25 | Cylinder Drive | 1 | Z44936 | A-Z44936 |
| 26 | - | 1 | Z61858 | A-Z61858 |
| 27 | - | 1 | Z62110 | A-Z62110 |
| 28 | - | 1 | Z62111 | A-Z62111 |

| Belt No. |  | No. of Belts | OEM  Part No. | PIX  Part No. |
|----------|---|--------------|--|--|
| 1 | Alternator And Fan Drive | 1 | H63772 | A-H63772 |
| 2 | Governor Drive | 1 | E57428 | A-E57428 |
| 3 | Platform Drive | 1 | E50873 | A-E50873 |
| 4 | Platform Drive | 1 | E58967 | A-E58967 |
| 6 | Water pump Drive (without Air Conditioning) | 1 | E53936 | A-E53936 |

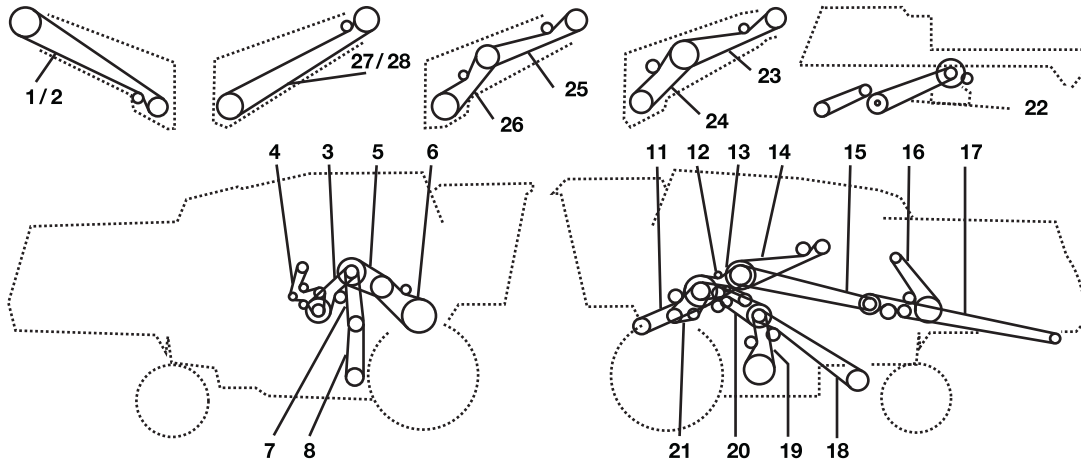



JOHN DEERE 2254 - 2256 - 2258



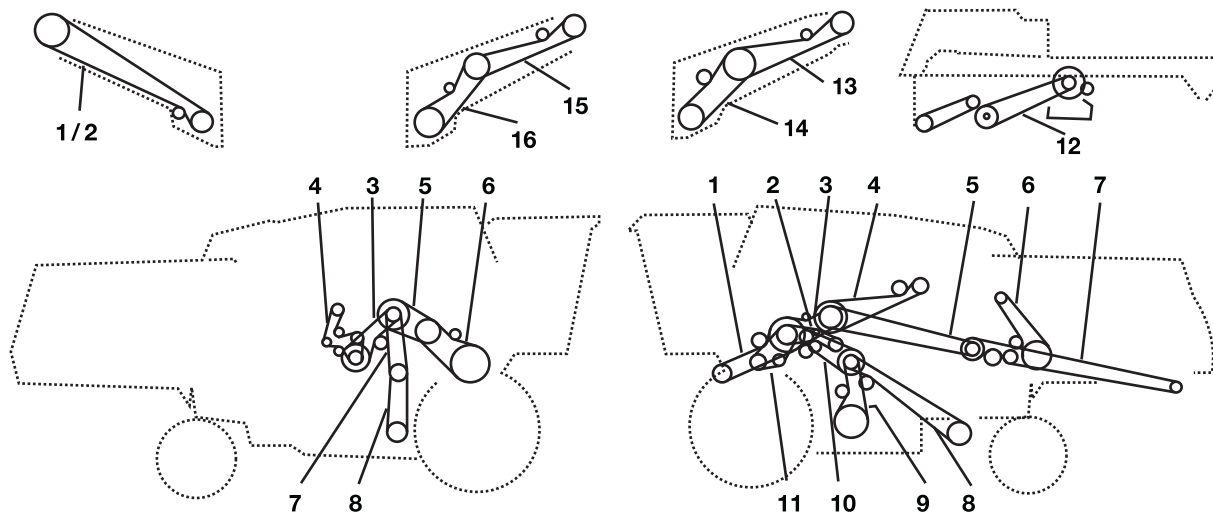



| Belt No. |  | No. of Belts | OEM  Part No. | PIX  Part No. |
|----------|---|--------------|--|--|
| 1 | - | 1 | Z59344 | A-Z59344 |
| 1 | - | 1 | Z61151 | A-Z61151 |
| 2 | - | 1 | Z57084 | A-Z57084 |
| 3 | - | 1 | Z64912 | A-Z64912 |
| 3 | - | 1 | Z61150 | A-Z61150 |
| 4 | - | 1 | Z61857 | A-Z61857 |
| 5 | - | 1 | Z59286 | A-Z59286 |
| 6 | - | 1 | Z59114 | A-Z59114 |
| 7 | - | 1 | Z59342 | A-Z59342 |
| 8 | - | 1 | Z60135 | A-Z60135 |
| 9 | - | 1 | Z59322 | A-Z59322 |
| 10 | - | 1 | Z56959 | A-Z56959 |
| 11 | - | 1 | Z56421 | A-Z56421 |
| 12 | - | 1 | Z48212 | A-Z48212 |
| 13 | - | 1 | Z61152 | A-Z61152 |
| 13 | - | 1 | Z60931 | A-Z60931 |
| 14 | - | 1 | Z62211 | A-Z62211 |
| 15 | - | 1 | Z61152 | A-Z61152 |
| 15 | - | 1 | Z60931 | A-Z60931 |
| 15 | - | 1 | Z54807 | A-Z54807 |
| 15 | - | 1 | Z58751 | A-Z58751 |
| 16 | - | 1 | Z61827 | A-Z61827 |
| 16 | - | 1 | Z62213 | A-Z62213 |
| 17 | - | 1 | Z62551 | A-Z62551 |
| 17 | - | 1 | Z54406 | A-Z54406 |
| 18 | - | 1 | Z62552 | A-Z62552 |
| 18 | - | 1 | Z62214 | A-Z62214 |
| 21 | - | 1 | Z54406 | A-Z54406 |
| 22 | - | 1 | Z59419 | A-Z59419 |
| 23 | - | 1 | Z63005 | A-Z63005 |
| 24 | - | 1 | Z59557 | A-Z59557 |
| 25 | Cylinder Drive | 1 | Z44936 | A-Z44936 |
| 26 | - | 1 | Z61858 | A-Z61858 |
| 27 | - | 1 | Z62110 | A-Z62110 |
| 28 | - | 1 | Z62111 | A-Z62111 |



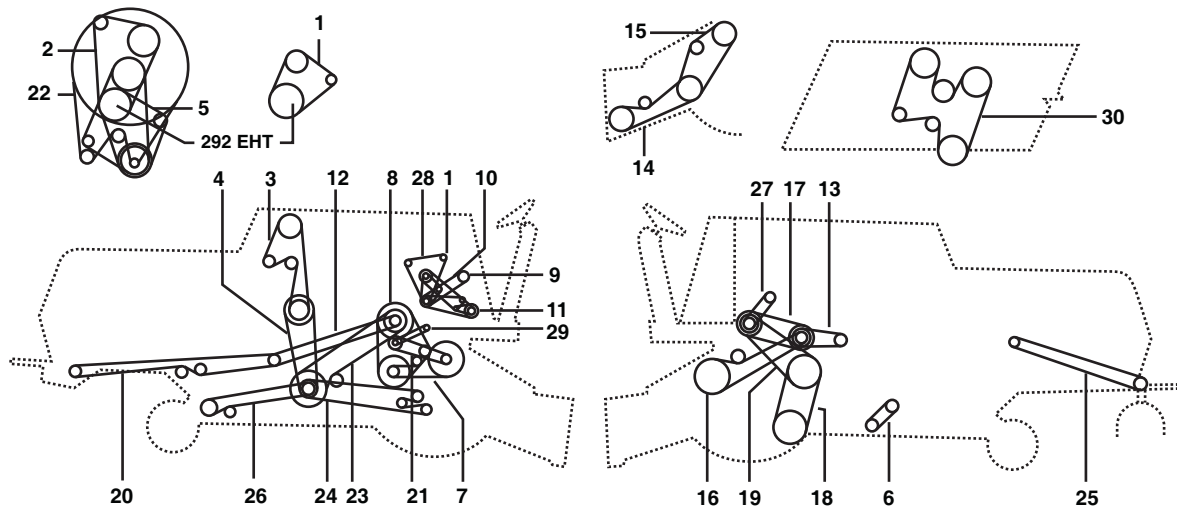

| Belt No. | | No. of Belts | OEM  Part No. | PIX  Part No. |
|----------|----------------|--------------|--|--|
| 1 | - | 1 | Z59344 | A-Z59344 |
| 1 | - | 1 | Z61151 | A-Z61151 |
| 2 | - | 1 | Z57084 | A-Z57084 |
| 3 | - | 1 | Z64912 | A-Z64912 |
| 3 | - | 1 | Z61150 | A-Z61150 |
| 4 | - | 1 | Z61857 | A-Z61857 |
| 5 | - | 1 | Z59286 | A-Z59286 |
| 6 | - | 1 | Z59114 | A-Z59114 |
| 7 | - | 1 | Z59342 | A-Z59342 |
| 8 | - | 1 | Z60135 | A-Z60135 |
| 9 | - | 1 | Z56421 | A-Z56421 |
| 10 | - | 1 | Z56959 | A-Z56959 |
| 11 | - | 1 | Z59322 | A-Z59322 |
| 12 | - | 1 | Z48212 | A-Z48212 |
| 13 | - | 1 | Z61152 | A-Z61152 |
| 13 | - | 1 | Z60931 | A-Z60931 |
| 14 | - | 1 | Z62211 | A-Z62211 |
| 15 | - | 1 | Z61152 | A-Z61152 |
| 15 | - | 1 | Z60931 | A-Z60931 |
| 15 | - | 1 | Z54807 | A-Z54807 |
| 15 | - | 1 | Z58751 | A-Z58751 |
| 16 | - | 1 | Z61827 | A-Z61827 |
| 16 | - | 1 | Z62213 | A-Z62213 |
| 21 | - | 1 | Z54406 | A-Z54406 |
| 22 | - | 1 | Z59419 | A-Z59419 |
| 23 | - | 1 | Z63005 | A-Z63005 |
| 24 | - | 1 | Z59557 | A-Z59557 |
| 25 | CYLINDER DRIVE | 1 | Z44936 | A-Z44936 |
| 26 | - | 1 | Z61858 | A-Z61858 |
| 27 | - | 1 | Z62110 | A-Z62110 |
| 28 | - | 1 | Z62111 | A-Z62111 |

JOHN DEERE 3300 - 3400





| Belt No. |  | No. of Belts | OEM  Part No. | PIX  Part No. |
|----------|---|--------------|--|--|
| 1 | Alternator And Waterpump Drive 292 (gas Engine) | 1 | H30634 | A-H30634 |
| 1 | Alternator And Waterpump Drive 329dh-02 | 1 | H80896 | A-H80896 |
| 2 | Alternator And Waterpump Drive 329dh-02and03 | 1 | H82724 | A-H82724 |
| 3 | Clean Grain Elevator U-joint Loading Auger | 1 | E60212 | A-E60212 |
| 3 | Clean Grain Elevator Drive | 1 | H87648 | A-H87648 |
| 4 | Clean Grain Elevator Countershaft | 1 | H23817 | A-H23817 |
| 5 | Engine Fan Androtary Screen Drive Shaft | 1 | H86275 | A-H86275 |
| 6 | Cleaning Fan Drive | 1 | H80726 | A-H80726 |
| 7 | Air Conditioning Compressor Drive 6329dh-01 | 1 | H86275 | A-H86275 |
| 7 | Air Conditioning Compressor Drive 329 (diesel Engine) | 1 | H77683 | A-H77683 |
| 7 | Compressor Drive (gas Engine) Ac 292 | 1 | H80896 | A-H80896 |
| 8 | Compressor Drive (diesel Engine) Ac 292 | 1 | H80896 | A-H80896 |
| 9 | Cylinder | 3 | AH80500 | A-AH80500 |
| 10 | Engine Fan Drive | 1 | H79236 | A-H79236 |
| 10 | Engine Fan Cab (without A/c Compressordrive) | 1 | H86271 | A-H86271 |
| 11 | Engine Fan Countershaft | 1 | H79235 | A-H79235 |
| 12 | Straw Chopper (front) | 1 | H20407 | A-H20407 |
| 14 | Platform Andcorn Head | 3 | AH76154 | A-AH76154 |
| 15 | Platform Andcorn Head Lower Variable | 3 | AH87197 | A-AH87197 |
| 16 | Platform Andcorn Head Middle Variable | 1 | H84441 | A-H84441 |
| 17 | Platform Andfeeder House (upper) | 1 | H76028 | A-H76028 |
| 18 | Countershaft (primary) | 2 | AH98052 | A-AH98052 |
| 19 | Propulsion Drive (lower) | 1 | H76136 | A-H76136 |
| 21 | Straw Chopper Drive (rear) | 1 | H79787 | A-H79787 |
| 22 | Rotary Deflector | 1 | H86039 | A-H86039 |
| 22 | Rotary Deflector | 1 | H86060 | A-H86060 |
| 23 | Countershaft (secondary) | 1 | H138762 | A-H138762 |
| 23 | Rotary Screen Drive | 1 | H86259 | A-H86259 |
| 25 | Shoe Supply Augers (grain) | 1 | H79285 | A-H79285 |
| 26 | Straw Spreader Drive | 1 | H80159 | A-H80159 |
| 27 | Tailings Auger (lower) | 1 | E63031 | A-E63031 |
| 28 | Unloading Auger Countershaft | 1 | H76136 | A-H76136 |
| 29 | Governor Drive | 1 | H82479 | A-H82479 |
| 31 | Clean Grain Elevator And Loading Auger Ext | 1 | H81222 | A-H81222 |

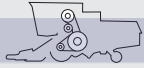

JOHN DEERE 3316

| Belt No. |  | No. of Belts | OEM  Part No. | PIX  Part No. |
|----------|---|--------------|--|--|
| 3 | - | 1 | YC19021 | A-YC19021 |
| 6 | - | 1 | AYC10133 | A-AYC10133 |
| 7 | - | 1 | YC10140 | A-YC10140 |
| 9 | - | 1 | YC14551 | A-YC14551 |
| 12 | - | 1 | YC19018 | A-YC19018 |
| 15 | - | 1 | YC10142 | A-YC10142 |
| 16 | - | 1 | YC19023 | A-YC19023 |

JOHN DEERE 3430



| Belt No. |  | No. of Belts | OEM  Part No. | PIX  Part No. |
|----------|--|--------------|--|--|
| 1 | Compressor Drive | 1 | N117674 | A-N117674 |
| 2 | Platform Drive | 1 | E56262 | A-E56262 |

JOHN DEERE 3830

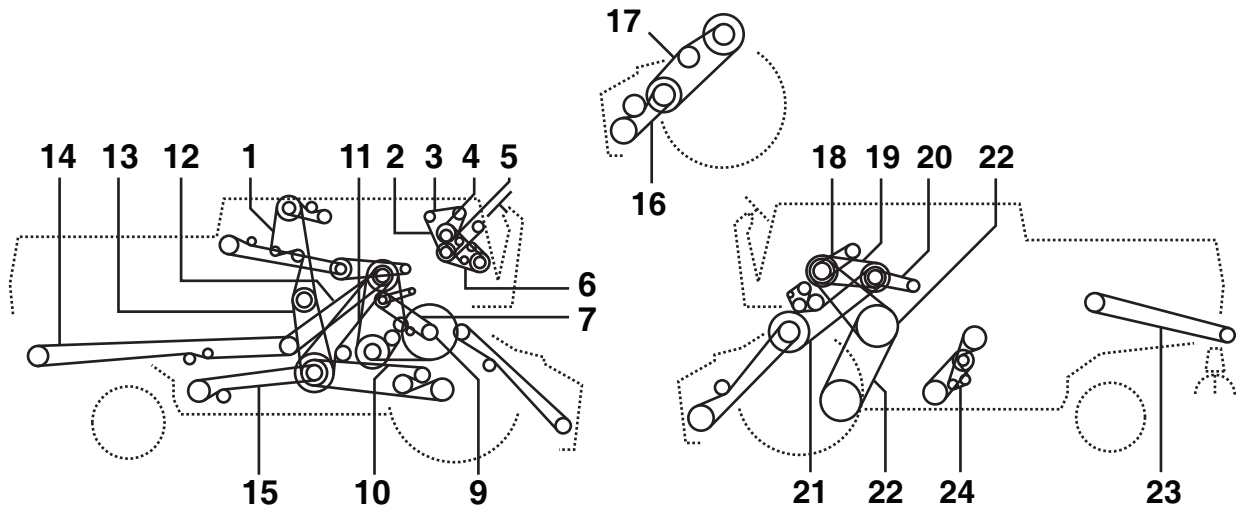

| Belt No. |  | No. of Belts | OEM  Part No. | PIX  Part No. |
|----------|---|--------------|--|--|
| 1 | Compressor Drive | 1 | N117674 | A-N117674 |
| 2 | Platform Drive | 1 | E72435 | A-E72435 |
| 3 | Rotary Screen Drive | 1 | H86259 | A-H86259 |
| 4 | Water pump Drive | 1 | N150864 | A-N150864 |
| 5 | Water pump Drive | 1 | E75596 | A-E75596 |

JOHN DEERE 4400



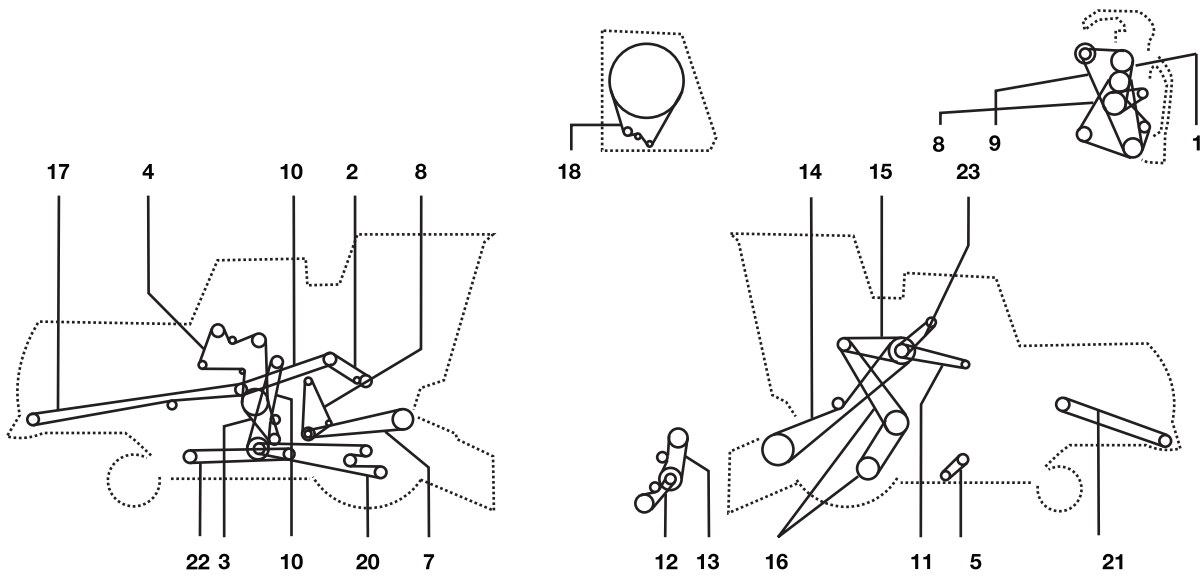

| Belt No. |  | No. of Belts | OEM  Part No. | PIX  Part No. |
|----------|---|--------------|--|--|
| 1 | Clean Grain Elevator U-joint Loading Auger | 1 | E60212 | A-E60212 |
| 1 | Clean Grain Elevator Drive | 1 | H87648 | A-H87648 |
| 2 | Alternator And Waterpump Drive 292 (gas Engine) | 1 | H30634 | A-H30634 |
| 2 | - | 1 | H80897 | A-H80897 |
| 3 | Governor Drive | 1 | H82479 | A-H82479 |
| 4 | Engine Fan Drive | 1 | H79236 | A-H79236 |
| 5 | Alternator & Waterpump Drive 292 (gas Engine) | 1 | H80896 | A-H80896 |
| 5 | Alternator & Waterpump Drive 329dh-02 (ser Nr 101301 - 151500) | 1 | H77683 | A-H77683 |
| 5 | Alternator & Waterpump Drive 329dh-02 (ser Nr From 151501) | 1 | H86275 | A-H86275 |
| 5 | Alternator & Waterpump Drive 329dh-02 (ser Nr Prior 101300) | 1 | H86275 | A-H86275 |
| 6 | Engine Fan Countershaft | 1 | H79235 | A-H79235 |
| 7 | Rotary Deflector | 1 | H86060 | A-H86060 |
| 7 | Rotary Deflector | 1 | H86039 | A-H86039 |
| 8 | Cylinder | 3 | AH80500 | A-AH80500 |
| 9 | - | 1 | H75816 | A-H75816 |
| 10 | Shoe Supply Augers (grain) | 1 | H79285 | A-H79285 |
| 11 | Secondary Countershaft | 1 | H80103 | A-H80103 |
| 12 | Straw Chopper (front) | 1 | H20407 | A-H20407 |
| 13 | Clean Grain Elevator Countershaft | 1 | H23817 | A-H23817 |
| 14 | Straw Chopper Drive (rear) | 1 | H79787 | A-H79787 |
| 15 | - | 1 | H79917 | A-H79917 |
| 16 | Platform Andcorn Head Lower Variable | 3 | AH87197 | A-AH87197 |
| 16 | Platform Andcorn Head | 3 | AH76154 | A-AH76154 |
| 17 | - | 1 | P46553 | A-P46553 |
| 18 | Propulsion Drive (lower) | 1 | H76136 | A-H76136 |
| 19 | Countershaft (primary) | 2 | AH98052 | A-AH98052 |
| 20 | A/c Compressor Drive 329(diesel Engine) | 1 | H77683 | A-H77683 |
| 21 | Platform & feeder House (upper) | 1 | H76028 | A-H76028 |
| 22 | Propulsion Drive | 1 | H75847 | A-H75847 |
| 23 | Straw Spreader Drive | 1 | H80159 | A-H80159 |
| 24 | Cleaning Fan Drive | 1 | H80726 | A-H80726 |

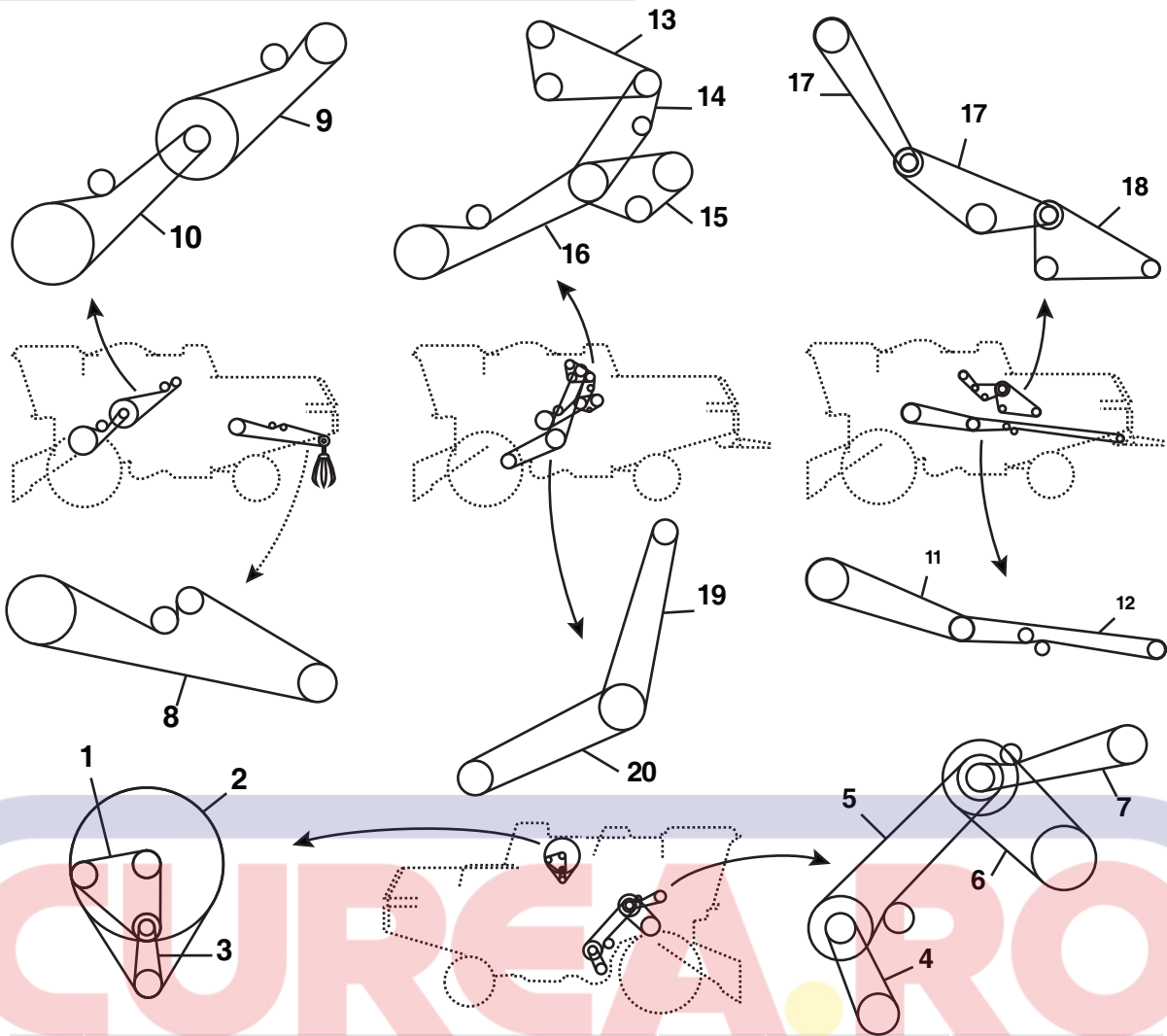

| Belt No. |  | No. of Belts | OEM  Part No. | PIX  Part No. |
|----------|---|--------------|--|--|
| 1 | Alternator And Waterpump Drive | 1 | J101813 | A-J101813 |
| 1 | Alternator And Waterpump Drive | 1 | H82724 | A-H82724 |
| 2 | Air Conditioning Compressor Drive | 1 | H86275 | A-H86275 |
| 3 | Engine Fan (cab Without Air Conditioning) | 1 | H86271 | A-H86271 |
| 3 | Engine Fan (cab With Air Conditioning) | 1 | H94373 | A-H94373 |
| 4 | Engine Fan And Rotary Screen Drive Shaft | 1 | H86275 | A-H86275 |
| 5 | Rotary Screen Drive | 1 | H86259 | A-H86259 |
| 6 | Countershaft (primary) | 2 | AH98052 | A-AH98052 |
| 8 | Unloading Auger Countershaft | 1 | H76136 | A-H76136 |
| 9 | Cleaning Fandrive | 1 | H80726 | A-H80726 |
| 10 | Straw Spreader Drive | 1 | H80159 | A-H80159 |
| 11 | Hydrostatic Reel Pump | 1 | H77683 | A-H77683 |
| 12 | Platform And Feeder House (upper) | 1 | H76028 | A-H76028 |
| 13 | Platform And Corn Head Middle Variable | 1 | P46553 | A-P46553 |
| 14 | Platform And Corn Head Lower Variable | 3 | AH87197 | A-AH87197 |
| 14 | Platform And Feeder House (Rice/Grain/Corn) | 3 | AH76154 | A-AH76154 |
| 15 | Beater Drive | 1 | H101352 | A-H101352 |
| 15 | Beater Drive | 1 | H86039 | A-H86039 |
| 16 | Shoe Supply Augers (Grain) | 1 | H79285 | A-H79285 |
| 17 | Clean Grain Elevator Drive | 1 | H81222 | A-H81222 |
| 18 | Clean Grain Elevator Countershaft | 1 | H23817 | A-H23817 |
| 20 | Cylinder | 3 | AH80500 | A-AH80500 |
| 21 | Tailings Auger (lower) | 1 | E63031 | A-E63031 |
| 22 | Straw Chopper Drive (rear) | 1 | H79787 | A-H79787 |
| 23 | Straw Chopper (front) | 1 | H20407 | A-H20407 |
| 24 | Countershaft (secondary) | 1 | H138762 | A-H138762 |
| 14 | Straw Spreaderdrive | 1 | Z33774 | A-Z33774 |
| 15 | Beater Drive | 1 | Z33790 | A-Z33790 |
| 16 | Feeder House Drive | 1 | Z38186 | A-Z38186 |
| 17 | Straw Chopper (front) | 1 | Z44761 | A-Z44761 |
| 18 | Straw Chopper Drive (rear) | 1 | Z44930 | A-Z44930 |

JOHN DEERE 4425



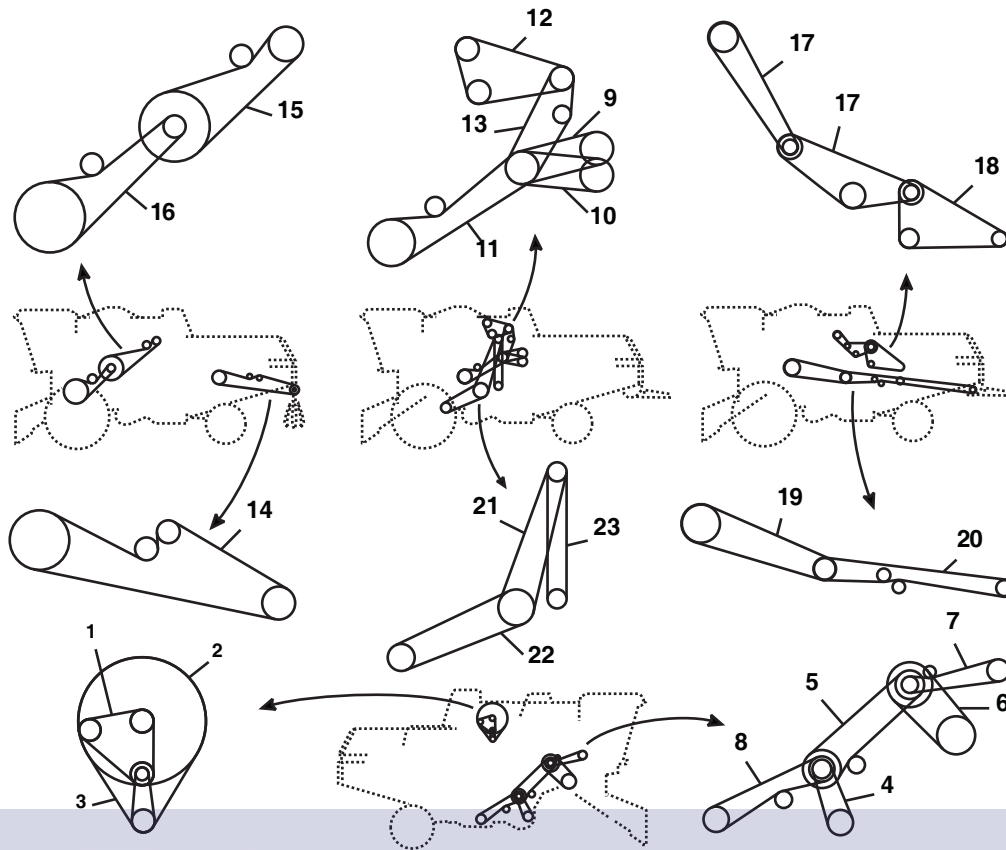

| Belt No. | | No. of Belts | OEM  Part No. | PIX  Part No. |
|----------|-------------------------------|--------------|--|--|
| 1 | Alternator Drive | 1 | Ar72036 | A-AR72036 |
| 2 | Countershaft To Rotary Screen | 1 | Z34786 | A-Z34786 |
| 3 | Crankshaft To Countershaft | 1 | Z32190 | A-Z32190 |
| 4 | Cleaning Fan | 1 | Z41178 | A-Z41178 |
| 5 | Separator Drive | 1 | Z34405 | A-Z34405 |
| 6 | Cylinder Drive | 1 | Z44936 | A-Z44936 |
| 7 | Tailings Elevator | 1 | Z45026 | A-Z45026 |
| 8 | Straw Spreader Drive | 1 | Z33774 | A-Z33774 |
| 9 | Beater Drive | 1 | Z33790 | A-Z33790 |
| 10 | Feeder House | 1 | Z38186 | A-Z38186 |
| 11 | Front Straw Chopper | 1 | Z44761 | A-Z44761 |
| 12 | Rear Straw Chopper | 1 | Z44930 | A-Z44930 |
| 13 | Compressor Drive | 1 | Z42756 | A-Z42756 |
| 14 | Condensor Fan | 1 | Z45482 | A-Z45482 |
| 15 | Hydraulic Pump Drive | 1 | Z34828 | A-Z34828 |
| 16 | Unloading Auger Drive | 1 | Z47911 | A-Z47911 |
| 17 | Condensor Rotary Blade | 2 | Z43863 | A-Z43863 |
| 18 | Condensor Rotary Blade | 1 | Z38704 | A-Z38704 |
| 19 | Upper Ground Drive | 2 | AZ35635 | A-AZ35635 |
| 20 | Lower Ground Drive | 1 | Z34099 | A-Z34099 |









| Belt No. | No. of Belts | OEM Part No. | PIX Part No. |
|----------|--------------|--------------|--------------|
| 1 | 1 | AR72036 | A-AR72036 |
| 2 | 1 | Z46764 | A-Z46764 |
| 2 | 1 | Z34786 | A-Z34786 |
| 3 | 1 | Z32190 | A-Z32190 |
| 4 | 1 | Z46365 | A-Z46365 |
| 5 | 1 | Z46366 | A-Z46366 |
| 6 | 1 | Z44936 | A-Z44936 |
| 7 | 1 | Z45026 | A-Z45026 |
| 8 | 1 | Z47912 | A-Z47912 |
| 9 | 1 | Z34828 | A-Z34828 |
| 10 | 1 | Z46759 | A-Z46759 |
| 11 | 1 | Z51212 | A-Z51212 |
| 12 | 1 | Z42756 | A-Z42756 |
| 13 | 1 | Z45482 | A-Z45482 |
| 14 | 1 | Z32041 | A-Z32041 |
| 15 | 1 | Z33790 | A-Z33790 |
| 16 | 1 | Z38186 | A-Z38186 |
| 17 | 2 | Z43863 | A-Z43863 |
| 18 | 1 | Z38704 | A-Z38704 |
| 19 | 1 | Z44761 | A-Z44761 |
| 20 | 1 | Z47763 | A-Z47763 |
| 20 | 1 | Z55645 | A-Z55645 |
| 21 | 2 | AZ37807 | A-AZ37807 |
| 22 | 1 | Z34099 | A-Z34099 |
| 23 | 1 | Z53290 | A-Z53290 |

JOHN DEERE 5000 SERIES FORAGE HARVESTER



| Belt No. |  | No. of Belts | OEM  Part No. | PIX  Part No. |
|----------|--|--------------|--|--|
| 0 | Alternator (Delco-Remy (6404)) (5200, 5400, 5440, 5460) | 1 | AR57266 | A-AR57266 |
| 0 | Alternator (delco-remy (6531a)) (5200, 5400) | 2 | AR53099 | A-AR53099 |
| 0 | Alternator (6619a) (5440, 5460) | 1 | AR86496 | A-AR86496 |
| 0 | Alternator (5420-5440 (european Edition)) | 1 | AR57266 | A-AR57266 |
| 0 | Compressor (5440, 5460, 5720-5820 (s/n 550001-680000)) | 1 | R71603 | A-R71603 |
| 0 | Cutterhead (dura-drum) (5200, 5400, 5440, 5460) | 3 | AE45931 | A-AE45931 |
| 0 | Cutterhead (j-knife) (5200, 5400, 5440, 5460) | 3 | AE45931 | A-AE45931 |
| 0 | Cutterhead (5720-5820 (prior To S/n 765001), 5730, 5830) | 3 | AE45931 | A-AE45931 |
| 0 | Fan (6531a)(5200, 5400) | 2 | AR53099 | A-AR53099 |
| 0 | Fan (6404) (5200-5400 (s/n 335846 & Above), 5440, 5460) | 1 | AR57266 | A-AR57266 |
| 0 | Fan (6619a)(5440, 5460) | 1 | AR86496 | A-AR86496 |
| 0 | Fan (6466ae) (5720, 5730) | 2 | RE29018 | A-RE29018 |
| 0 | Fan (5420-5440 (European Edition)) | 1 | AR57266 | A-AR57266 |
| 0 | Reverse Knife Sharpener Drive (dura-drum) (5200, 5400) | 1 | E36784 | A-E36784 |
| 0 | Reverse Knife Sharpener Drive (j-knife) (5200, 5400) | 1 | E12574 | A-E12574 |
| 0 | Reverse Knife Sharpener Drive (5440-5460 (prior To S/n 425001)) | 1 | E12574 | A-E12574 |
| 0 | Reverse Knife Sharpener Drive (5440-5460 (s/n 425001 & Above), 5720, 5730, 5820, 5830) | 1 | E36784 | A-E36784 |
| 0 | Reverse Knife Sharpener Drive (5420-5440 (European Edition Prior To S/n 425001)) | 1 | E12574 | A-E12574 |
| 0 | Reverse Knife Sharpener Drive (5420-5440 (European Edition S/n 425001 & Above)) | 1 | E36784 | A-E36784 |
| 0 | Hydraulic Pump (5200, 5400, 5460 (prior To S/n 380001)) | 1 | H86271 | A-H86271 |
| 0 | Hydraulic Pump (5460 (s/n 380001 & Above), 5720, 5730, 5820, 5830) | 1 | E72830 | A-E72830 |
| 0 | Hydraulic Pump (5440 (prior To S/n 380001)) | 1 | H86272 | A-H86272 |

JOHN DEERE 5200

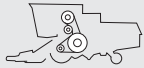

| Belt No. |  | No. of Belts | OEM  Part No. | PIX  Part No. |
|----------|---|--------------|--|--|
| 2 | - | 2 | AR57266 | A-AR57266 |
| 3 | - | 2 | AR53099 | A-AR53099 |
| 4 | - | 1 | E36784 | A-E36784 |
| 5 | - | 1 | E12574 | A-E12574 |
| 6 | - | 3 | AE45931 | A-AE45931 |

| Belt No. |  | No. of Belts | OEM  Part No. | PIX  Part No. |
|----------|---|--------------|--|--|
| 1 | - | 2 | AR54592 | A-AR54592 |

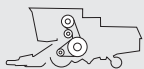

JOHN DEERE 5460

| Belt No. |  | No. of Belts | OEM  Part No. | PIX  Part No. |
|----------|---|--------------|--|--|
| 1 | - | 1 | E72830 | A-E72830 |

JOHN DEERE 6000 SERIES FORAGE HARVESTER

| Belt No. |  | No. of Belts | OEM  Part No. | PIX  Part No. |
|----------|--|--------------|--|--|
| 0 | Compressor Drive (6610, 6710, 6810, 6910) | 1 | Z48472 | A-Z48472 |
| 1 | Rotary Radiator Screen Drive (6610, 6650, 6710, 6750, 6810, 6850, 6910, 6950) | 1 | Z48567 | A-Z48567 |
| 2 | Engine Belt (6081hz004) (6610, 6650) | 1 | R136235 | A-R136235 |
| 4 | Fan (6710) | 1 | Z55771 | A-Z55771 |
| 5 | Fan (upper Belt) (6810, 6910, 6950) | 2 | AZ56225 | A-AZ56225 |
| 6 | Alternator (lower Belt) (6810, 6910, 6950) | 1 | Z58886 | A-Z58886 |
| 7 | Fan (lower Belt) (6750, 6850) | 1 | R502461 | A-R502461 |
| 7 | Fan (lower Belt) (6750, 6850) | 1 | R503312 | A-R503312 |
| 8 | Alternator (upper Belt) (6750, 6850) | 1 | R503505 | A-R503505 |
| 9 | Deflector And Tension Rolls (6610, 6650, 6710, 6750, 6810, 6850, 6910, 6950) | 3 | AZ39677 | A-AZ39677 |
| 9 | Belt Drive (for Grain Crop Kernel Processor) (6650, 6750, 6850, 6950) | 3 | AZ61336 | A-AZ61336 |
| 10 | Deflector And Tension Rolls (6650-6750 (prior To S/n 503553)) | 2 | AZ43805 | A-AZ43805 |
| 10 | Deflector And Tension Rolls (6850-6950 (s/n 503553 & Above)) | 2 | AZ43805 | A-AZ43805 |
| 11 | Main Drive (1000 Rpm Cutter Head) (6610) | 2 | AZ51314 | A-AZ51314 |
| 11 | Main Drive 1000 Rpm Cutter Head) (6810, 6910) | 2 | AZ51312 | A-AZ51312 |
| 11 | Main Drive (1000 Rpm Cutter Head) (6650) | 2 | AZ53570 | A-AZ53570 |
| 11 | Main Drive (1150 Rpm Cutter Head) (6650) | 2 | AZ51641 | A-AZ51641 |
| 11 | Main Drive (1000 Rpm Cutter Head) (6750) | 2 | AZ53569 | A-AZ53569 |
| 11 | Main Drive (1150 Rpm Cutter Head) (6850 (prior To S/n 505596)) | 2 | AZ53559 | A-AZ53559 |
| 11 | Main Drive (1150 Rpm Cutter Head) (6650, 6750, 6850 (s/n 505596 & Above)) | 2 | AZ51639 | A-AZ51639 |
| 11 | Main Drive (1150 Rpm Cutter Head) (6950) | 2 | AZ51638 | A-AZ51638 |
| 12 | Kernel Processor (1800 Rpm Fan Speed) (6610, 6650, 6710, 6750, 6810, 6850, 6910, 6950) | 2 | AZ39676 | A-AZ39676 |

JOHN DEERE 6000 SERIES FORAGE HARVESTER

| Belt No. |  | No. of Belts | OEM  Part No. | PIX  Part No. |
|----------|--|--------------|--|--|
| 12 | Kernel Processor (2050 Rpm Fan Speed) (6610, 6650, 6710, 6750, 6810, 6850, 6910, 6950) | 2 | Az39678 | A-AZ39678 |
| 12 | For Grain Crop Kernel Processor (6650, 6750, 6850, 6950) | 3 | AZ61389 | A-AZ61389 |
| 12 | For Grain Crop Kernel Processor (6650, 6750, 6850, 6950) | 2 | AZ43804 | A-AZ43804 |
| 12 | Power Deflector Drive (1800 Rpm Fan Speed) (6610, 6710, 6810, 6910) | 2 | AZ43804 | A-AZ43804 |
| 12 | Power Deflector Drive (2050 Rpm Fan Speed) (6610, 6710, 6810, 6910) | 2 | AZ39676 | A-AZ39676 |

JOHN DEERE 6000 HY-CYCLE

| Belt No. |  | No. of Belts | OEM  Part No. | PIX  Part No. |
|----------|---|--------------|--|--|
| 1 | - | 1 | N202856 | A-202856 |



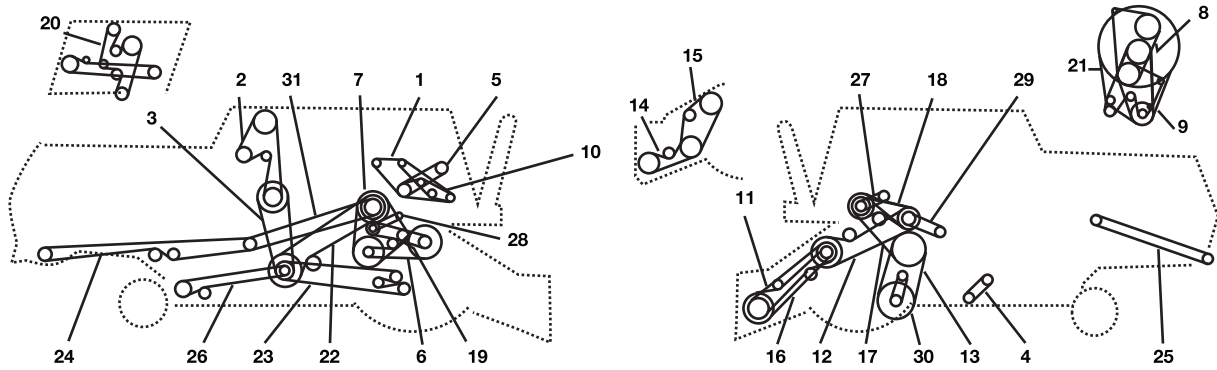

JOHN DEERE 6600 - 6600 SIDEHILL





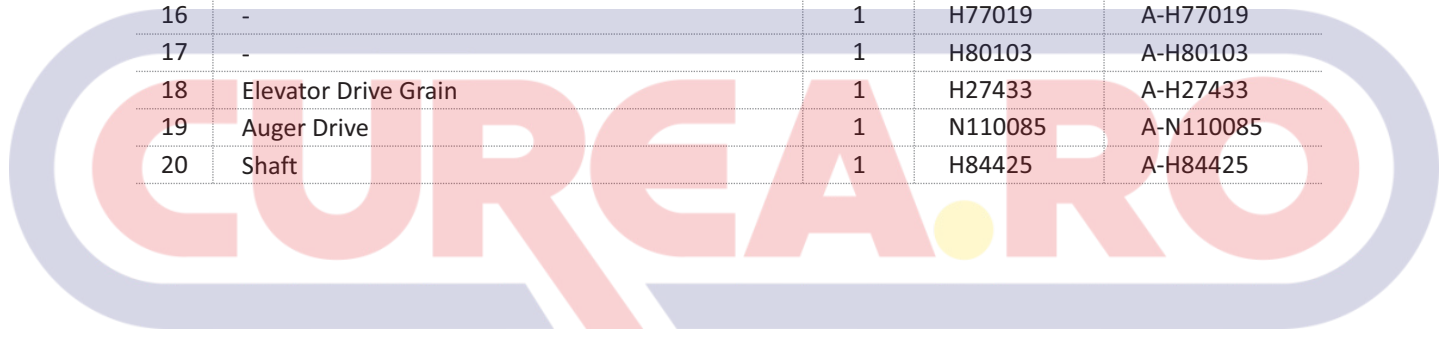

| Belt No. |  | No. of Belts | OEM  Part No. | PIX  Part No. |
|----------|---|--------------|--|--|
| 1 | Sickle Drive | 1 | 856559 | A-856559 |
| 1 | Alternator & Waterpump Drive | 1 | H82724 | A-H82724 |
| 1 | Countershaft (primary) | 2 | AH75638 | A-AH75638 |
| 2 | U-joint Loading Auger | 1 | H23950 | A-H23950 |
| 2 | Sickle Drive | 1 | 857862 | A-857862 |
| 3 | Clean Grain Elevator Countershaft | 1 | H27433 | A-H27433 |
| 4 | Cleaning Fan Drive | 1 | H108668 | A-H108668 |
| 5 | Air Conditioning Compressor Drive | 1 | H80896 | A-H80896 |
| 5 | Air Conditioning Compressor Drive (6600 Sidehill) | 1 | H87459 | A-H87459 |
| 5 | Air Conditioning Compressor Drive (6600 Sidehill) | 1 | R71603 | A-R71603 |
| 6 | Cylinder N=280-845 Rpm | 3 | AH80505 | A-AH80505 |
| 6 | Cylinder N=407-828 Rpm | 3 | AH80503 | A-AH80503 |
| 6 | Cylinder N=287-873 Rpm Slow Speed Inter. speed | 1 | H96423 | A-H96423 |
| 7 | Cylinder - Intermediate Shaft | 1 | H113749 | A-H113749 |
| 8 | Engine Fan 6404dh | 1 | H86271 | A-H86271 |
| 8 | Engine Fan 6329gh-02 And 6329dh-01 | 1 | H86272 | A-H86272 |
| 9 | Engine Fan & rotary Screen Drive Shaft (6600 Sidehill) | 1 | H137207 | A-H137207 |
| 11 | Feeder Conveyor (regular Feeder House) | 1 | H77766 | A-H77766 |
| 11 | Feeder Conveyor (long Feeder House) | 1 | H125380 | A-H125380 |
| 12 | Platform & feeder House (upper) | 1 | H76030 | A-H76030 |
| 12 | Platform & feeder House Variable Speed (upper) | 1 | H23927 | A-H23927 |
| 13 | Hydrostatic Propulsion Drive (lower) | 2 | AH84633 | A-AH84633 |
| 13 | Hydrostatic Propulsion Drive (lower) | 1 | H88576 | A-H88576 |
| 13 | Propulsion Posi-torque (lower) | 1 | H75846 | A-H75846 |
| 14 | Platform Andcorn Head | 3 | AH76154 | A-AH76154 |
| 14 | Platform And Corn Head (6600 Sidehill) | 3 | AH89436 | A-AH89436 |
| 15 | Platform And Corn Head Middle Variable | 1 | P46553 | A-P46553 |
| 15 | Platform And Corn Head Middle Variable | 1 | H84441 | A-H84441 |
| 16 | Platform And Feeder House (lower) Regular | 1 | H77765 | A-H77765 |
| 16 | Platform And Feeder House (lower) Long | 1 | H79796 | A-H79796 |
| 17 | Hydrostatic Propulsion Drive (upper) | 2 | AH84633 | A-AH84633 |
| 17 | Propulsion Posi-torque (upper) | 2 | AH21301 | A-AH21301 |
| 17 | Hydrostatic Propulsion Drive (upper) | 1 | H88576 | A-H88576 |
| 17 | Propulsion Posi-torque (upper) (6600 Sidehill) | 2 | AH21301 | A-AH21301 |
| 17 | Propulsion Posi-torque (upper) (6600 Sidehill) | 2 | AH87127 | A-AH87127 |

JOHN DEERE 6602

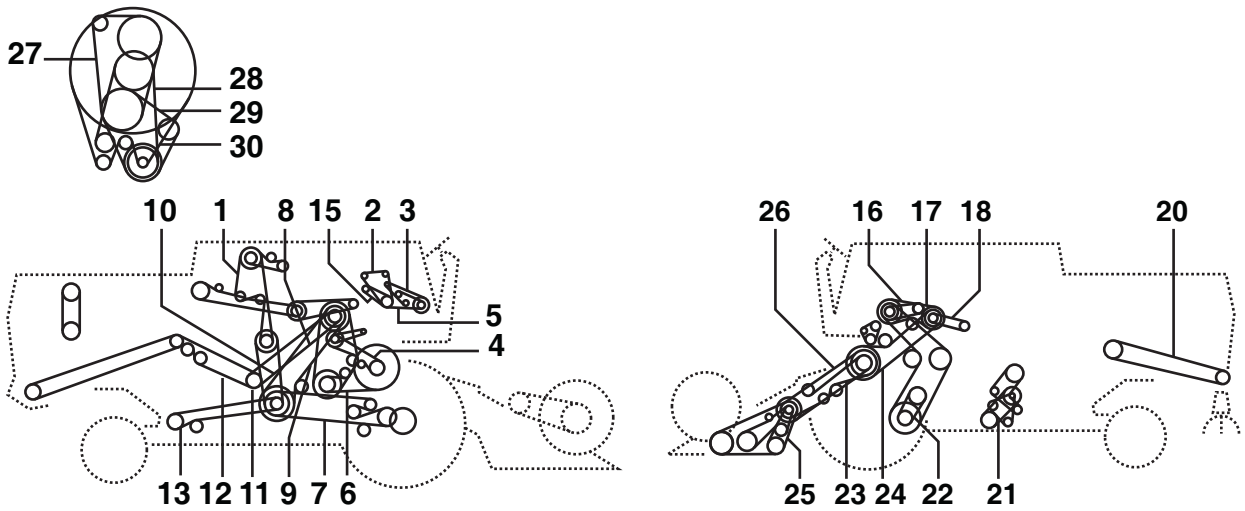
| Belt No. |  | No. of Belts | OEM  Part No. | PIX  Part No. |
|----------|---|--------------|--|--|
| 1 | Discharge Auger Shaft | 1 | P41508 | A-P41508 |
| 2 | Traction Drive | 3 | AH79627 | A-AH79627 |
| 3 | Purify Drive | 1 | H76273 | A-H76273 |
| 4 | Hydraulic Pump Drive | 1 | H81378 | A-H81378 |
| 5 | Feeder Channel (upper) | 1 | H76030 | A-H76030 |
| 6 | Sickle Knife Drive | 1 | H81222 | A-H81222 |
| 7 | Cutting Table Drive | 1 | H81524 | A-H81524 |
| 8 | Elevator Drive Grain | 1 | H23950 | A-H23950 |
| 9 | Alternator Drive | 1 | H82724 | A-H82724 |
| 9 | Alternator Drive | 1 | R52507 | A-R52507 |
| 10 | Fan Drive | 1 | H79237 | A-H79237 |
| 11 | - | 1 | H86060 | A-H86060 |
| 12 | Fan Drive | 1 | H79235 | A-H79235 |
| 13 | Cylinder Drive | 1 | H84421 | A-H84421 |
| 14 | Feeder Channel | 1 | H77010 | A-H77010 |
| 15 | Cylinder Drive Intermediate | 1 | H75565 | A-H75565 |
| 16 | - | 1 | H77019 | A-H77019 |
| 17 | - | 1 | H80103 | A-H80103 |
| 18 | Elevator Drive Grain | 1 | H27433 | A-H27433 |
| 19 | Auger Drive | 1 | N110085 | A-N110085 |
| 20 | Shaft | 1 | H84425 | A-H84425 |





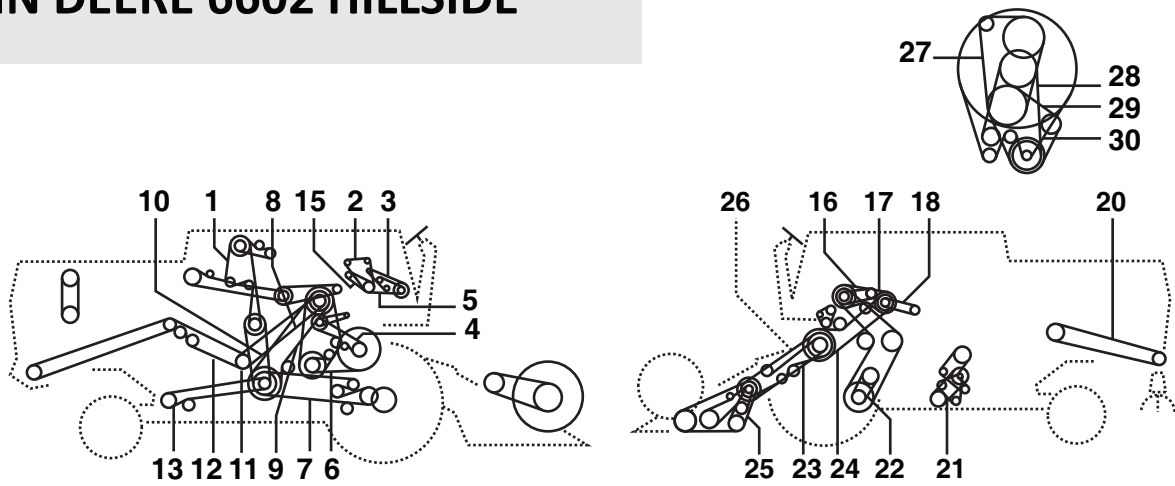

| Belt No. |  | No. of Belts | OEM  Part No. | PIX  Part No. |
|----------|---|--------------|--|--|
| 18 | Countershaft (primary) | 1 | H84462 | A-H84462 |
| 18 | Countershaft (primary) (6600 Sidehill) | 1 | H84462 | A-H84462 |
| 18 | Countershaft (primary) (6600 Sidehill) | 1 | H108175 | A-H108175 |
| 19 | Rotary Deflector | 1 | H86039 | A-H86039 |
| 19 | Rotary Deflector | 1 | H86061 | A-H86061 |
| 20 | Clean Grain Elevator Drive | 1 | H77766 | A-H77766 |
| 21 | Rotary Screen Drive | 1 | H86259 | A-H86259 |
| 22 | Countershaft (secondary) | 1 | H77019 | A-H77019 |
| 23 | Shoe Supply Augers (grain) | 1 | H77010 | A-H77010 |
| 24 | Straw Chopper Drive (rear) | 1 | H79789 | A-H79789 |
| 25 | Straw Spreader Drive | 1 | H26858 | A-H26858 |
| 26 | Tailings Auger (lower) | 1 | N110085 | A-N110085 |
| 27 | Unloading Auger Countershaft (6600 Sidehill) | 1 | H76150 | A-H76150 |
| 27 | Unloading Auger Countershaft (6600 Sidehill) | 1 | H84424 | A-H84424 |
| 29 | Hydrostatic Reel Pump | 1 | H77683 | A-H77683 |
| 30 | Hydrostatic Charge Pump Drive | 1 | T12042 | A-T12042 |
| 30 | Hydrostatic Charge Pump Drive | 1 | T199T | A-T199T |
| 31 | Straw Chopper Drive | 1 | H80103 | A-H80103 |
| 32 | 6404dh | 1 | H85377 | A-H85377 |
| 33 | - | 1 | H75846 | A-H75846 |

JOHN DEERE 6602 HILLSIDE



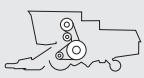

| Belt No. |  | No. of Belts | OEM  Part No. | PIX  Part No. |
|----------|---|--------------|--|--|
| 1 | Clean Grain Elevator Drive | 1 | H23950 | A-H23950 |
| 2 | Alternator And Waterpump Drive | 1 | H82724 | A-H82724 |
| 2 | Alternator And Waterpump Drive | 1 | R52507 | A-R52507 |
| 2 | Alternator And Waterpump Drive (sub R70871) | 1 | R52603 | A-R52603 |
| 2 | Alternator And Waterpump Drive (turbo) | 1 | R70871 | A-R70871 |
| 2 | Alternator And Waterpump Drive (turbo) | 1 | H79236 | A-H79236 |
| 2 | Alternator And Waterpump Drive (gasoline) | 1 | H80896 | A-H80896 |
| 3 | Engine Fan Drive (gasoline) | 1 | H79237 | A-H79237 |
| 3 | Engine Fan Drive (diesel) | 1 | H79237 | A-H79237 |
| 3 | Engine Fan Drive (diesel) | 1 | H84740 | A-H84740 |
| 4 | Rotary Deflector (sub H86060) | 1 | H82318 | A-H82318 |
| 4 | Rotary Deflector | 1 | H86060 | A-H86060 |
| 4 | Rotary Deflector | 1 | H86039 | A-H86039 |
| 4 | Rotary Deflector | 1 | H101352 | A-H101352 |
| 5 | Engine Fan Countershaft (gasoline) | 1 | H79235 | A-H79235 |
| 5 | Engine Fan Countershaft (diesel) | 1 | H79235 | A-H79235 |
| 5 | Engine Fan Countershaft (diesel) | 1 | H85382 | A-H85382 |
| 6 | Cylinder (350-1058 Rpm) | 3 | AH80503 | A-AH80503 |
| 6 | Cylinder (350-1058 Rpm) (sub H96408) | 1 | H84421 | A-H84421 |
| 6 | Cylinder (350-1058 Rpm) | 1 | H96408 | A-H96408 |
| 7 | Shoe Grain Supply Augers | 1 | H77010 | A-H77010 |
| 8 | Cylinder, Intermediate Shaft (sub H113749) | 1 | H75565 | A-H75565 |
| 8 | Cylinder, Intermediate Shaft | 1 | H113749 | A-H113749 |
| 9 | Countershaft (secondary) | 1 | H77019 | A-H77019 |
| 10 | Straw Chopper (front) | 1 | H80103 | A-H80103 |
| 11 | Clean Grain Elevator Countershaft | 1 | H27433 | A-H27433 |
| 12 | Straw Chopper (rear) | 1 | H81653 | A-H81653 |
| 13 | Tailings Auger (lower) | 1 | P50335 | A-P50335 |
| 13 | Tailings Auger (lower) | 1 | N110085 | A-N110085 |
| 15 | Compressor (sub R69562) | 1 | R46098 | A-R46098 |
| 15 | Compressor (sub R71603) | 1 | R69562 | A-R69562 |
| 15 | Compressor | 1 | R71603 | A-R71603 |
| 16 | Discharge Auger Shaft Countershaft | 1 | P41508 | A-P41508 |
| 16 | Discharge Auger Shaft Countershaft (6404th-02) | 1 | H84424 | A-H84424 |
| 17 | Primary Countershaft | 2 | AH79671 | A-AH79671 |
| 17 | Primary Countershaft | 1 | H84462 | A-H84462 |

JOHN DEERE 6602 HILLSIDE

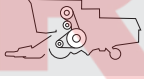

| Belt No. |  | No. of Belts | OEM  Part No. | PIX  Part No. |
|----------|---|--------------|--|--|
| 17 | Primary Countershaft (sub For H108175) | 1 | H84425 | A-H84425 |
| 17 | Primary Countershaft (6404th-02) | 1 | H108175 | A-H108175 |
| 18 | Hydraulic Reel Drive | 1 | H77683 | A-H77683 |
| 19 | Propulsion/traction Drive | 3 | AH79627 | A-AH79627 |
| 20 | Straw Spreader | 1 | H26858 | A-H26858 |
| 21 | Purify Drive (sub H108668) | 1 | H76273 | A-H76273 |
| 21 | Cleaning Fan, 66-1/2" Long | 1 | H108668 | A-H108668 |
| 22 | Charge Pump/hydraulicpump Drive | 1 | H81378 | A-H81378 |
| 23 | Platform Andfeeder House (upper) | 1 | H76030 | A-H76030 |
| 24 | Feeder Conveyor | 1 | H81222 | A-H81222 |
| 25 | Sickle Drive/cutting Table Drive | 1 | H81524 | A-H81524 |
| 26 | Platform Andfeeder House (lower) | 1 | H33885 | A-H33885 |
| 27 | Alternator And Water Pump | 1 | H79236 | A-H79236 |
| 28 | Engine Fan | 1 | H86271 | A-H86271 |
| 29 | Engine Fan Androtary Screen Drive Shaft | 1 | H86273 | A-H86273 |
| 30 | Rotary Screen Drive | 1 | H86259 | A-H86259 |

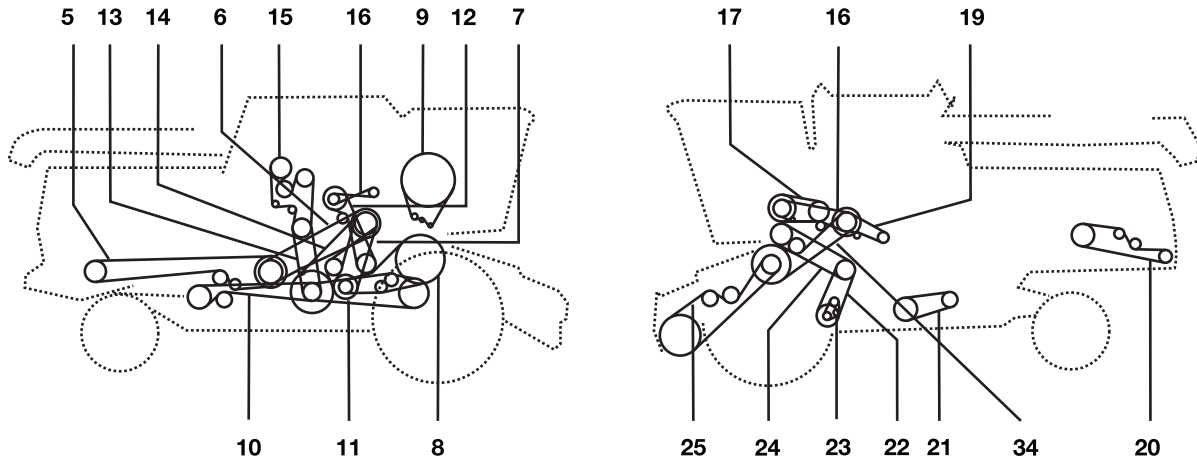
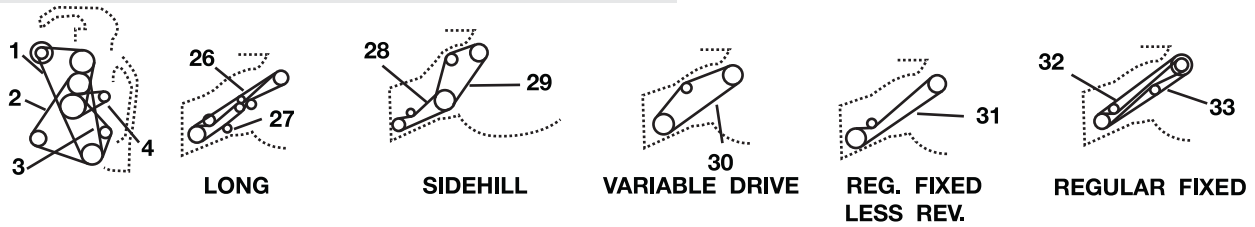

JOHN DEERE 6610

| Belt No. |  | No. of Belts | OEM  Part No. | PIX  Part No. |
|----------|---|--------------|--|--|
| 1 | - | 1 | Z48567 | A-Z48567 |
| 2 | - | 2 | AZ39678 | A-AZ39678 |
| 3 | - | 2 | AZ39676 | A-AZ39676 |
| 4 | - | 3 | AZ39677 | A-AZ39677 |
| 5 | - | 2 | AZ51314 | A-AZ51314 |

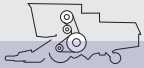

JOHN DEERE 6620





| Belt No. |  | No. of Belts | OEM  Part No. | PIX  Part No. |
|----------|---|--------------|--|--|
| 0 | Torque-sensing Countershaft Drive | 1 | H113749 | A-H113749 |
| 0 | Countershaft (upper) 2480 Mm | 1 | P49415 | A-P49415 |
| 1 | Alternator And Waterpump Drive | 1 | H79236 | A-H79236 |
| 2 | Rotary Screen Drive | 1 | H86273 | A-H86273 |
| 3 | Engine Fan Drive | 1 | H86272 | A-H86272 |
| 4 | Air Conditioning Compressor Drive (serial Nr. 600000 - ...) | 1 | H113565 | A-H113565 |
| 4 | Air Conditioning Compressor Drive (serial Nr. ... - 600001) | 1 | R71603 | A-R71603 |
| 5 | Straw Chopper Drive (rear) | 1 | H103344 | A-H103344 |
| 6 | Straw Chopper Drive | 1 | H101436 | A-H101436 |
| 7 | Countershaft 2650 Mm (lower) | 1 | E60212 | A-E60212 |
| 8 | Cylinder - 3-banded (n=315 To 830 Rpm) (serial Nr. - ... - 551900) | 1 | H96423 | A-H96423 |
| 8 | Cylinder - 3-banded (serial Nr. ... - 551900) | 1 | H96408 | A-H96408 |
| 8 | Cylinder - 4-banded (optional) (serial Nr. 551899 - ...) | 1 | H96422 | A-H96422 |
| 8 | Cylinder - 4-banded (standard) (serial Nr. 551899 - ...) | 1 | H110375 | A-H110375 |
| 9 | Rotary Screen Drive | 1 | H86259 | A-H86259 |
| 10 | Tailings Auger Drive | 1 | H118730 | A-H118730 |
| 11 | Shoe Supply Augers | 1 | H77010 | A-H77010 |
| 12 | Beater (100 % Beater Speed) | 1 | H96414 | A-H96414 |
| 12 | Beater (150 % Beater Speed) | 1 | H101469 | A-H101469 |
| 13 | Clean Grain Elevator Countershaft | 1 | H27433 | A-H27433 |
| 14 | Countershaft (secondary) | 1 | H81222 | A-H81222 |
| 14 | Countershaft (secondary) | 1 | H110300 | A-H110300 |
| 15 | Clean Grain Elevator And Loading | 1 | H77766 | A-H77766 |
| 17 | Unloading Auger Drive | 2 | AH96300 | A-AH96300 |
| 18 | Multi-groove Separator Drive | 1 | H108175 | A-H108175 |

| Belt No. |  | No. of Belts | OEM  Part No. | PIX  Part No. |
|----------|---|--------------|--|--|
| 19 | Hydraulic Reel Pump Drive | 1 | H86275 | A-H86275 |
| 19 | Hydraulic Reel Pump Drive | 1 | H137207 | A-H137207 |
| 20 | Straw Spreader (front) | 1 | H112421 | A-H112421 |
| 21 | Cleaning Fan Drive | 1 | H108668 | A-H108668 |
| 22 | Ground Drive (lower) | 2 | AH84633 | A-AH84633 |
| 22 | Ground Drive (lower) | 1 | H75846 | A-H75846 |
| 23 | Hydrostatic Charge Pump (serial Nr. 610300 - ...) | 1 | T32517 | A-T32517 |
| 23 | Hydrostatic Charge Pump (serial Nr. ... - 610300) | 1 | T199T | A-T199T |
| 24 | Ground Drive (upper) | 2 | AH84633 | A-AH84633 |
| 24 | Posi-torque (upper) Ground Drive | 2 | AH87127 | A-AH87127 |
| 25 | Feeder House Drive (regular) (serial Nr. 502551-615100) | 1 | H111519 | A-H111519 |
| 26 | Feeder Conveyor Drive (serial Nr. ... - 403301) | 1 | H125380 | A-H125380 |
| 27 | Feeder House - Lower, Long (serial Nr. ... - 403301) | 1 | H79796 | A-H79796 |
| 28 | Multi-groove (sidehill Only) | 3 | AH89436 | A-AH89436 |
| 29 | Feeder House - Lower, Long (serial Nr. 403300 - ...) | 1 | H97929 | A-H97929 |
| 29 | Feeder House (upper) (sidehill Only) (serial Nr. ... - 610300) | 1 | H84441 | A-H84441 |
| 30 | Feeder House Drive Conveyor | 1 | H110921 | A-H110921 |
| 30 | Feeder House - Lower Fixed Less Reverser (serial Nr 61030 - ...) | 1 | H116422 | A-H116422 |
| 31 | Feeder House - Lower Fixed Less Reverser (serial Nr 615100 - ...) | 1 | Z30130 | A-Z30130 |
| 32 | Feeder House - Lower, Reg. Fixed (serial Nr. 502550 - ...) | 1 | H77765 | A-H77765 |
| 33 | Feeder House Conveyor, Reg. Fixed (serial Nr. 502550 - ...) | 1 | H77766 | A-H77766 |
| 34 | Feeder House - Less Reverser (serial Nr. 615100 - ...) | 1 | H76030 | A-H76030 |
| 34 | Feeder House - Reverser, variator Drive | 1 | H23927 | A-H23927 |



JOHN DEERE 6622

| Belt No. |  | No. of Belts | OEM  Part No. | PIX  Part No. |
|----------|---|--------------|--|--|
| 1 | Alternator And Water pump Drive | 1 | H79236 | A-H79236 |
| 2 | Air Conditioning Compressor Drive | 1 | R71603 | A-R71603 |
| 3 | Engine Fan Drive | 1 | H86272 | A-H86272 |
| 4 | Rotary Screen Drive | 1 | H86273 | A-H86273 |
| 5 | Left-hand Side | 1 | H136881 | A-H136881 |
| 6 | Beater Drive | 1 | H101469 | A-H101469 |
| 7 | Torque-sensing Countershaft Drive | 1 | H113749 | A-H113749 |
| 8 | Cylinder - 3-banded (slow Speed) | 1 | H96423 | A-H96423 |
| 8 | Cylinder - 4-banded (optional) | 1 | H96422 | A-H96422 |
| 8 | Cylinder - 4-banded (standard) | 1 | H110375 | A-H110375 |
| 9 | Clean Grain Elevator and loading | 1 | H23950 | A-H23950 |
| 10 | Clean Grain Elevator Counter shaft | 1 | H27433 | A-H27433 |
| 11 | Clean Grain Elevator and loading | 1 | H77766 | A-H77766 |
| 12 | Clean Grain Elevator Counter shaft | 1 | H27433 | A-H27433 |
| 13 | Counter shaft (secondary) | 1 | H81222 | A-H81222 |
| 13 | Counter shaft (secondary) | 1 | H110300 | A-H110300 |
| 14 | Shoe Supply Augers | 1 | H77010 | A-H77010 |
| 15 | Tailings Auger Drive | 1 | H118730 | A-H118730 |
| 16 | Straw Chopper Drive (rear) | 1 | H103344 | A-H103344 |
| 17 | Straw Chopper Drive | 1 | H101436 | A-H101436 |
| 18 | Straw Spreader (front) | 1 | H112421 | A-H112421 |
| 19 | - | 1 | H86275 | A-H86275 |
| 20 | Cleaning Fan drive | 1 | H108668 | A-H108668 |
| 21 | Sickle Drive | 1 | H81524 | A-H81524 |
| 22 | Unloading Auger Drive | 2 | AH96300 | A-AH96300 |
| 23 | Feeder House Drive | 1 | H23927 | A-H23927 |
| 24 | Feeder House (lower) | 1 | H77765 | A-H77765 |
| 25 | Multi-groove Separator Drive | 1 | H108175 | A-H108175 |
| 26 | Hydrostatic Ground Drive | 3 | AH79627 | A-AH79627 |
| 27 | Hydrostatic Charge Pump Drive | 1 | H86273 | A-H86273 |
| 28 | Feeder House Drive | 1 | H76030 | A-H76030 |
| 29 | Feeder Conveyor Drive | 1 | H81222 | A-H81222 |
| 30 | Feeder House (lower) | 1 | H33885 | A-H33885 |



JOHN DEERE 6650

| Belt No. |  | No. of Belts | OEM  Part No. | PIX  Part No. |
|----------|---|--------------|--|--|
| 1 | - | 1 | R136235 | A-R136235 |

JOHN DEERE 6700 - 6700S

| Belt No. |  | No. of Belts | OEM  Part No. | PIX  Part No. |
|----------|---|--------------|--|--|
| 1 | - | 1 | R135199 | A-R135199 |

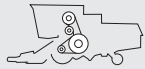

JOHN DEERE 6710

| Belt No. |  | No. of Belts | OEM  Part No. | PIX  Part No. |
|----------|---|--------------|--|--|
| 2 | - | 1 | Z55771 | A-Z55771 |

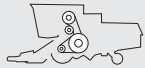

JOHN DEERE 6750

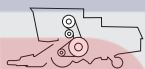
| Belt No. |  | No. of Belts | OEM  Part No. | PIX  Part No. |
|----------|---|--------------|--|--|
| 1 | - | 1 | R503312 | A-R503312 |
| 2 | - | 1 | R502599 | A-R502599 |



JOHN DEERE 6810

| Belt No. |  | No. of Belts | OEM  Part No. | PIX  Part No. |
|----------|--|--------------|---|---|
| 1 | - | 2 | AZ51312 | A-AZ51312 |
| 2 | - | 1 | Z58886 | A-Z58886 |
| 3 | - | 2 | AZ56225 | A-AZ56225 |



JOHN DEERE 6850

| Belt No. |  | No. of Belts | OEM  Part No. | PIX  Part No. |
|----------|---|--------------|--|--|
| 1 | - | 2 | AZ53559 | A-AZ53559 |
| 2 | - | 2 | AZ51639 | A-AZ51639 |



JOHN DEERE 6950

| Belt No. |  | No. of Belts | OEM  Part No. | PIX  Part No. |
|----------|---|--------------|--|--|
| 2 | - | 2 | AZ51638 | A-AZ51638 |



JOHN DEERE 7000 SERIES FORAGE HARVESTER

| Belt No. |  | No. of Belts | OEM  Part No. | PIX  Part No. |
|----------|---|--------------|--|--|
| 1 | Rotary radiator Screen Drive (long Belt) (7180, 7250,7280,7350,7380,7450,7480,7550,7580) | 1 | Z103479 | A-Z103479 |
| 1 | Rotary Radiator Screen Drive (long Belt) (7750, 7780, 7850, 7950, 7980) | 1 | Z103479 | A-Z103479 |
| 3 | Rotary Radiator Screen Drive (7200, 7300 (prior To S/n 508318)) | 1 | Z48567 | A-Z48567 |
| 4 | Rotary Radiator Screen Drive (7300 (s/n 508318 & Above), 7400, 7500, 7700, 7800) | 1 | Z78860 | A-Z78860 |
| 6 | Engine Belt (7180, 7250) | 1 | L114468 | A-L114468 |
| 6 | Engine Belt (7200 (Prior To S/n 507479)) | 1 | R136235 | A-R136235 |
| 6 | Engine Belt (7200 (S/n 507479 & Above)) | 1 | L114293 | A-L114293 |
| 7 | Alternator (upper Belt) (7300 (s/n 507479 & Above)) | 1 | L115660 | A-L115660 |
| 7 | Alternator (upper Belt) (7350, 7380, 7450, 7480, 7550, 7580 7750, 7780) | 1 | L115660 | A-L115660 |
| 7 | Alternator (upper Belt, It4 Engine) (7480, 7580, 7780) | 1 | R123456 | A-R123456 |
| 7 | Alternator (upper Belt) (7400-7500-7700 (s/n 507479 & Above), 7800) | 1 | L110603 | A-L110603 |
| 8 | Fan (lower Belt) (7300) | 1 | R503312 | A-R503312 |
| 8 | Fan (lower Belt) (7400, 7500, 7700, 7800) | 1 | R502461 | A-R502461 |
| 8 | Fan (lower Belt) (7350, 7380, 7450, 7480, 7550, 7580, 7750, 7780) | 1 | R502461 | A-R502461 |
| 9 | Alternator (upper Belt) (7200, 7300 (Prior To S/n 507479), 7400, 7500) | 1 | R503932 | A-R503932 |
| 9 | Alternator (upper Belt) (7200, 7400-7500-7700 (Prior To S/n 507479)) | 1 | Z73506 | A-Z73506 |
| 11 | Alternator (7800, 7850) | 1 | L110599 | A-L110599 |
| 12 | Fan (7800 (prior To S/n 508100)) | 1 | Z101214 | A-Z101214 |
| 15 | Alternator (qsk19 Engine) (7950, 7980) | 1 | HXE17071 | A-HXE17071 |
| 16 | Deflector/tension Rolls (7180, 7200, 7250, 7280, 7300) | 3 | AZ39677 | A-AZ39677 |
| 16 | Deflector/tension Rolls (7350, 7380, 7400, 7450, 7480, 7500, 7550, 7580) | 3 | AZ39677 | A-AZ39677 |
| 16 | Deflector/tension Rolls for Kernel Processor (7180,7200,7250, 7280,7300, 7350,7380) | 3 | AZ61336 | A-AZ61336 |
| 16 | Deflector/tension Rolls For Kernel Processor (7400, 7450, 7480, 7500, 7550, 7580) | 3 | AZ61336 | A-AZ61336 |
| 16 | Deflector/tension Rolls (7700, 7750, 7780, 7800, 7850, 7950, 7980) | 3 | AZ61336 | A-AZ61336 |
| 16 | Deflector/tension Rolls (7750-7850-7950 (USA)) | 3 | AZ101386 | A-AZ101386 |
| 16 | Deflector/tension Rolls (7780, 7980) | 3 | AXE29294 | A-AXE29294 |
| 17 | Main Drive (1000rpm Cutter Head,1800 & 2000rpm Fan Speed) (7180, 7200, 7250, 7550) | 2 | AZ53570 | A-AZ53570 |
| 17 | Main Drive (1150rpm Cutter Head,1800 & 2000rpm Fan Speed) (7180, 7200, 7250, 7550) | 2 | AZ51641 | A-AZ51641 |
| 17 | Main Drive (1000rpm Cutter Head,1800 & 2000rpm Fan Speed) (7280, 7300, 7350, 7380) | 2 | AZ53569 | A-AZ53569 |
| 17 | Main Drive (1000rpm Cutter Head,1800 & 2000rpm Fan Speed) (7400, 7450, 7480, 7550) | 2 | AZ53559 | A-AZ53559 |
| 17 | Main Drive(1150 Rpm cutter Head, 1800 Rpm fan Speed)(7180,7200, 7250,7300, 7350,7550) | 2 | AZ51639 | A-AZ51639 |
| 17 | Main Drive (1150rpm Cutter Head,1800 & 2000rpm Fan Speed) (7400, 7450, 7480, 7550) | 2 | AZ51639 | A-AZ51639 |
| 17 | Main7750, 7800,drive7850)(1150 Rpm Cutter Head, 1800 & 2000 Rpm Fan Speed) (7500, 7580, 7700, | 2 | AZ51638 | A-AZ51638 |



JOHN DEERE 7000 SERIES FORAGE HARVESTER

| Belt No. |  | No. of Belts | OEM  Part No. | PIX  Part No. |
|----------|---|--------------|--|--|
| 17 | Main Drive (1095 Rpm Cutter Head) (7700, 7750, 7800, 7850) | 2 | Az58519 | A-AZ58519 |
| 18 | Processor7950 (prior to (1600s/nrpm,510524), Na, Kernel7800, 7850)processor, Sorghum/ Bean Speed) (7700, 7750- | 3 | AZ100808 | A-AZ100808 |
| 18 | Processor(s/n 510524 &(1600above),rpm,7780, Na, Kernel7980)processor, Sorghum/bean Speed) (7750-7950 | 1 | HXE13951 | A-HXE13951 |
| 18 | Processor (1800 Rpm, Na) (7180, 7200, 7250, 7280, 7300, 7350, 7380, 7400, 7450, 7480) | 3 | AZ100807 | A-AZ100807 |
| 18 | Processor (1800 Rpm, Na) (7500, 7550, 7580) | 3 | AZ100807 | A-AZ100807 |
| 18 | Processor (2000 Rpm, Na) (7180, 7200, 7250, 7280, 7300, 7350, 7380, 7400) | 3 | AZ100808 | A-AZ100808 |
| 18 | Processor (2000 Rpm, Na) (7450, 7480, 7500, 7550, 7580) | 3 | AZ100808 | A-AZ100808 |
| 18 | Processor (2000 Rpm, Na) (7180, 7280, 7250, 7350, 7380, 7450, 7480, 7550, 7580) | 1 | HXE13957 | A-HXE13957 |
| 18 | Processor7550 (prior To(1800s/nrpm,511028), Kernel7280)processor, Outsiden) (7180, 7200, 7250-7350-7450- | 3 | AZ100808 | A-AZ100808 |
| 18 | Processor (1800 Rpm, Kernel Processor, outside Na)(7300, 7380, 7400, 7480, 7500, 7580) | 3 | AZ100808 | A-AZ100808 |
| 18 | Processor(s/n 511028 &(1800above),rpm,7280) Kernel Processor, Outsiden) (7180, 7250-7350-7450-7550 | 1 | HXE13957 | A-HXE13957 |
| 18 | Processor (1800 Rpm, Kernel Processor, Outside Na) (7380, 7480, 7580) | 1 | HXE13957 | A-HXE13957 |
| 18 | Processor7250, 7280, 7300,(18007350,rpm,7380, Kernel/grain7400, 7450, 7480)crop Processor, Outside Na) (7180, 7200, | 3 | AZ100807 | A-AZ100807 |
| 18 | Processor (1800 Rpm, Kernel/grain Crop Processor, Outside Na) (7500, 7550,7580) | 3 | AZ100807 | A-AZ100807 |
| 18 | Processor7550 (prior To(2000s/nrpm,511027), Kernel7280)processor, Outside Na) (7180, 7200, 7250-7350-7450- | 3 | AZ100809 | A-AZ100809 |
| 18 | Processor (2000 Rpm, Kernel Processor, Outside Na) (7300, 7380,7400, 7480, 7500, 7580) | 3 | AZ100809 | A-AZ100809 |
| 18 | Processor(s/n 511028 &(2000above),rpm,7280) Kernel Processor, Outside Na) (7180, 7250-7350 -7450-7550 | 1 | HXE13951 | A-HXE13951 |
| 18 | Processor (2000 Rpm, Kernel Processor, Outside Na) (7380, 7480, 7580) | 1 | HXE13951 | A-HXE13951 |
| 18 | Processor (for Power Chute) (7700, 7750, 7780, 7800, 7850, 7950, 7980) | 2 | AZ100806 | A-AZ100806 |
| 18 | Processor (for Kernel Processor) (7700, 7750, 7780, 7800, 7850, 7950, 7980) | 3 | AZ100810 | A-AZ100810 |

JOHN DEERE 7440

| Belt No. |  | No. of Belts | OEM  Part No. | PIX  Part No. |
|----------|---|--------------|--|--|
| 2 | - | 1 | N31437 | A-N31437 |
| 3 | - | 1 | L4339N | A-L4339N |
| 4 | - | 1 | N121113 | A-N121113 |
| 5 | - | 1 | N125041 | A-N125041 |

JOHN DEERE 7445

| Belt No. |  | No. of Belts | OEM  Part No. | PIX  Part No. |
|----------|---|--------------|--|--|
| 1 | - | 1 | N129916 | A-N129916 |
| 2 | - | 1 | N129955 | A-N129955 |
| 3 | - | 1 | N33746 | A-N33746 |
| 4 | - | 1 | N129508 | A-N129508 |



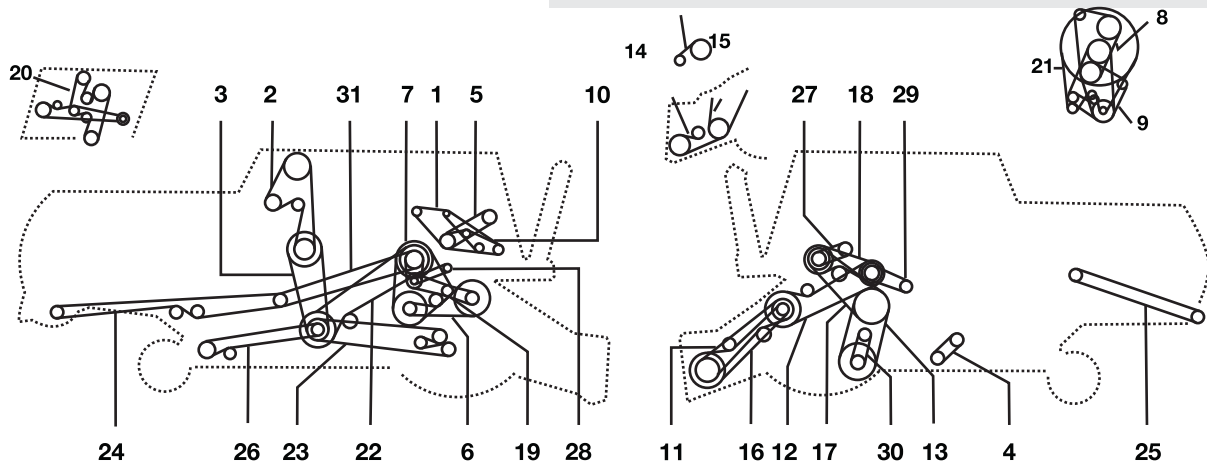

JOHN DEERE 7700





| Belt No. |  | No. of Belts | OEM  Part No. | PIX  Part No. |
|----------|---|--------------|--|--|
| 1 | Alternator And Waterpump Drive (diesel Engine) | 1 | AR41576 | A-AR41576 |
| 1 | Alternator And Waterpump Drive (gas Engine) | 1 | H80896 | A-H80896 |
| 1 | Alternator And Waterpump Drive (diesel Engine) | 1 | H82724 | A-H82724 |
| 1 | Alternator And Waterpump Drive 404th-01 | 1 | R70871 | A-R70871 |
| 1 | Alternator And Waterpump Drive 404th-01 | 1 | H79236 | A-H79236 |
| 1 | Alternator And Waterpump Drive 404dh-04 | 1 | R52507 | A-R52507 |
| 2 | Clean Grain Elevator U-joint Loading Auger | 1 | H23950 | A-H23950 |
| 3 | Clean Grain Elevator Countershaft | 1 | H27433 | A-H27433 |
| 4 | Cleaning Fan Drive | 1 | H108668 | A-H108668 |
| 5 | Air Conditioning Compressor Drive 404dh-04 | 1 | H87459 | A-H87459 |
| 5 | Air Conditioning Compressor Drive (gas Engine) | 1 | H80897 | A-H80897 |
| 5 | Air Conditioning Compressor Drive 404th-01 | 1 | H80896 | A-H80896 |
| 5 | Air Conditioning Compressor Drive 404th-01 | 1 | R71603 | A-R71603 |
| 6 | Cylinder N=280-845 Rpm | 3 | AH80505 | A-AH80505 |
| 6 | Cylinder N=407-1228 Rpm | 3 | AH80503 | A-AH80503 |
| 6 | Cylinder N=287-873 Rpm Slow Speed Intermediate speed | 1 | H96423 | A-H96423 |
| 6 | Cylinder N=414-1250 Rpm | 1 | H96408 | A-H96408 |
| 7 | Cylinder - Intermediate Shaft | 1 | H113749 | A-H113749 |
| 8 | Engine Fan Drive | 1 | H86271 | A-H86271 |
| 9 | Engine Fan Androtary Screen Drive Shaft 404dh-04 | 1 | H137207 | A-H137207 |
| 9 | Engine Fan Androtary Screen Drive Shaft 404th-01 | 1 | H86273 | A-H86273 |
| 10 | Engine Fan Countershaft 404th-01 | 1 | H84745 | A-H84745 |
| 10 | Engine Fan Countershaft 404dh-01 | 1 | H79235 | A-H79235 |
| 11 | Feeder Conveyor (regular Feeder House) | 1 | H77766 | A-H77766 |
| 11 | Feeder Conveyor (long Feeder House) | 1 | H125380 | A-H125380 |
| 12 | Platform Andfeeder House (upper) | 1 | H76030 | A-H76030 |
| 12 | Platform Andfeeder House Variable Speed (upper) | 1 | H23927 | A-H23927 |
| 13 | Hydrostatic Propulsion Drive (lower) | 2 | AH84633 | A-AH84633 |
| 13 | Propulsion Posi-torque (lower) | 1 | H75846 | A-H75846 |
| 14 | Platform Andcorn Head | 3 | AH76154 | A-AH76154 |
| 14 | Platform And Corn Head Lower Variable | 3 | AH89436 | A-AH89436 |
| 14 | Propulsion Drive (lower) | 1 | H75846 | A-H75846 |
| 15 | Platform And Corn Head Middle Variable | 1 | P46553 | A-P46553 |
| 15 | Platform And Corn Head Middle Variable | 1 | H84441 | A-H84441 |
| 16 | Platform And Feeder House Lower Regular | 1 | H77765 | A-H77765 |

JOHN DEERE 7700

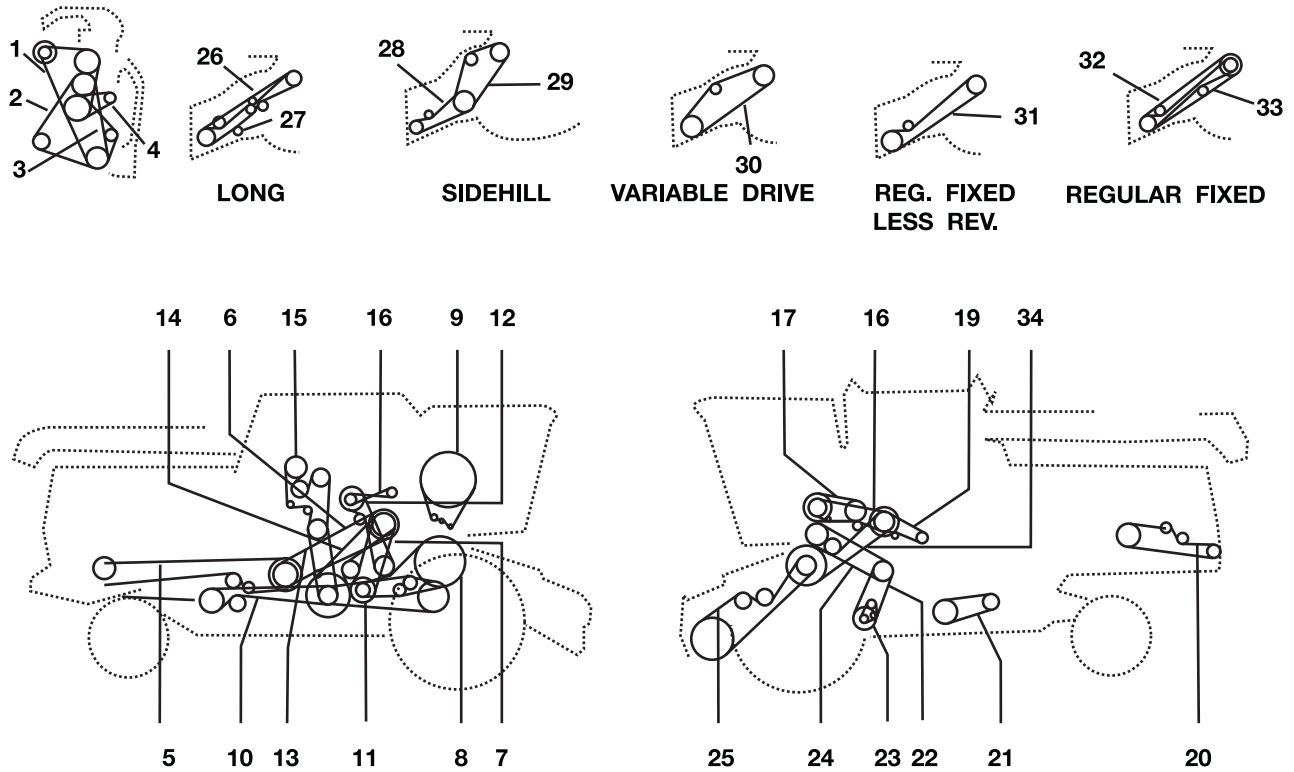

| Belt No. |  | No. of Belts | OEM  Part No. | PIX  Part No. |
|----------|---|--------------|--|--|
| 16 | Platform And Feeder House Lower Long | 1 | H79796 | A-H79796 |
| 17 | Hydrostatic Propulsion Drive (upper) | 2 | AH84633 | A-AH84633 |
| 17 | Propulsion Posi-torque (upper) 404d | 2 | AH21301 | A-AH21301 |
| 17 | Propulsion Posi-torque (upper) 404t | 2 | AH87127 | A-AH87127 |
| 17 | Propulsion Drive (upper) | 1 | H75846 | A-H75846 |
| 18 | Countershaft (primary) | 1 | H84462 | A-H84462 |
| 18 | Countershaft (primary) 404th-01 | 1 | H108175 | A-H108175 |
| 18 | Countershaft (primary) | 2 | AH75638 | A-AH75638 |
| 19 | Rotary Deflector | 1 | H86039 | A-H86039 |
| 19 | Rotary Deflector | 1 | H86061 | A-H86061 |
| 20 | Clean Grain Elevator Drive | 1 | H77766 | A-H77766 |
| 21 | Rotary Screen Drive | 1 | H86259 | A-H86259 |
| 22 | Countershaft (secondary) | 1 | H77019 | A-H77019 |
| 23 | Shoe Supply Augers (grain) | 1 | H77010 | A-H77010 |
| 24 | Straw Chopper Drive (rear) | 1 | H79789 | A-H79789 |
| 25 | Straw Spreader Drive | 1 | H26858 | A-H26858 |
| 26 | Tailings Auger (lower) | 1 | N110085 | A-N110085 |
| 27 | Unloading Auger Countershaft | 1 | H76150 | A-H76150 |
| 27 | Unloading Auger Countershaft 404th-01 | 1 | H84424 | A-H84424 |
| 29 | Hydrostatic Reel Pump | 1 | H77683 | A-H77683 |
| 30 | Hydrostatic Charge Pump Drive | 1 | T12042 | A-T12042 |
| 30 | Hydrostatic Charge Pump Drive | 1 | T199T | A-T199T |
| 31 | Straw Chopper Drive | 1 | H80103 | A-H80103 |
| 32 | - | 1 | AR41628 | A-AR41628 |
| 33 | - | 1 | H84740 | A-H84740 |

JOHN DEERE 7720

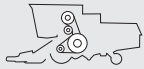

| Belt No. | | No. of Belts | OEM  Part No. | PIX  Part No. |
|----------|-------------------------------------|--------------|---|---|
| 1 | Alternator And Waterpump Drive | 1 | H79236 | A-H79236 |
| 2 | Air Conditioning Compressor Drive | 1 | H113565 | A-H113565 |
| 2 | Air Conditioning Compressor Drive | 1 | R71603 | A-R71603 |
| 3 | Fan Drive | 1 | H86271 | A-H86271 |
| 4 | Rotary Screen Drive | 1 | H86273 | A-H86273 |
| 5 | Rotary Screen Drive | 1 | H86259 | A-H86259 |
| 6 | Countershaft (upper) 2480 Mm | 1 | P49415 | A-P49415 |
| 7 | Countershaft 2650 Mm (lower) | 1 | E60212 | A-E60212 |
| 8 | Straw Chopper Drive (rear) | 1 | H103344 | A-H103344 |
| 9 | Straw Chopper Drive | 1 | H101436 | A-H101436 |
| 10 | Torque-sensing Countershaft Drive | 1 | H113749 | A-H113749 |
| 11 | Cylinder - 3-banded (n=315-830 Rpm) | 1 | H96423 | A-H96423 |
| 11 | Cylinder - 4-banded (optional) | 1 | H96422 | A-H96422 |
| 11 | Cylinder - 4-banded (standard) | 1 | H110375 | A-H110375 |
| 12 | Cylinder - 3-banded | 1 | H96408 | A-H96408 |
| 12 | Clean Grain Elevator And Loading | 1 | H77766 | A-H77766 |
| 13 | Clean Grain Elevator Countershaft | 1 | H27433 | A-H27433 |
| 14 | Countershaft (secondary) | 1 | H81222 | A-H81222 |
| 14 | Countershaft (secondary) | 1 | H110300 | A-H110300 |
| 15 | Shoe Supply Augers | 1 | H77010 | A-H77010 |
| 16 | Tailings Auger Drive | 1 | H118730 | A-H118730 |
| 17 | Beater (100 % Beater Speed) | 1 | H96414 | A-H96414 |
| 17 | Beater (150 % Beater Speed) | 1 | H101469 | A-H101469 |
| 18 | Feeder House Drive | 1 | H76030 | A-H76030 |
| 19 | Feeder Conveyor Drive | 1 | H125380 | A-H125380 |
| 20 | Feeder House (lower) | 1 | H79796 | A-H79796 |

JOHN DEERE 7720

| Belt No. |  | No. of Belts | OEM  Part No. | PIX  Part No. |
|----------|---|--------------|--|--|
| 21 | Feeder House Drive | 1 | H76030 | A-H76030 |
| 22 | Feeder Conveyor Drive | 1 | H77766 | A-H77766 |
| 23 | Drive (lower) | 1 | H77765 | A-H77765 |
| 24 | Unloading Auger Drive | 2 | AH96300 | A-AH96300 |
| 25 | Feeder House Drive | 1 | H23927 | A-H23927 |
| 26 | Feeder House - Lower (regular) | 1 | H111519 | A-H111519 |
| 26 | Feeder House - Lower (long) | 1 | H97929 | A-H97929 |
| 27 | Multi-groove Separator Drive | 1 | H108175 | A-H108175 |
| 28 | Feeder House Drive | 1 | H76030 | A-H76030 |
| 29 | Drive (lower) | 1 | Z30130 | A-Z30130 |
| 30 | Cleaning Fandrive | 1 | H108669 | A-H108669 |
| 31 | Feeder House Drive Conveyor | 1 | H110921 | A-H110921 |
| 32 | Feeder House Drive | 1 | H23927 | A-H23927 |
| 33 | Straw Spreader (front) | 1 | H112421 | A-H112421 |
| 34 | Ground Drive (upper) | 2 | AH87127 | A-AH87127 |
| 35 | Ground Drive (lower) | 1 | H75846 | A-H75846 |
| 36 | Ground Drive (upper) | 2 | AH84633 | A-AH84633 |
| 37 | Ground Drive (upper) | 1 | H137207 | A-H137207 |
| 38 | Ground Drive (lower) | 2 | AH84633 | A-AH84633 |
| 39 | Hydrostatic Charge Pump Drive | 1 | T32517 | A-T32517 |
| 39 | Hydrostatic Charge Pump Drive | 1 | T199T | A-T199T |

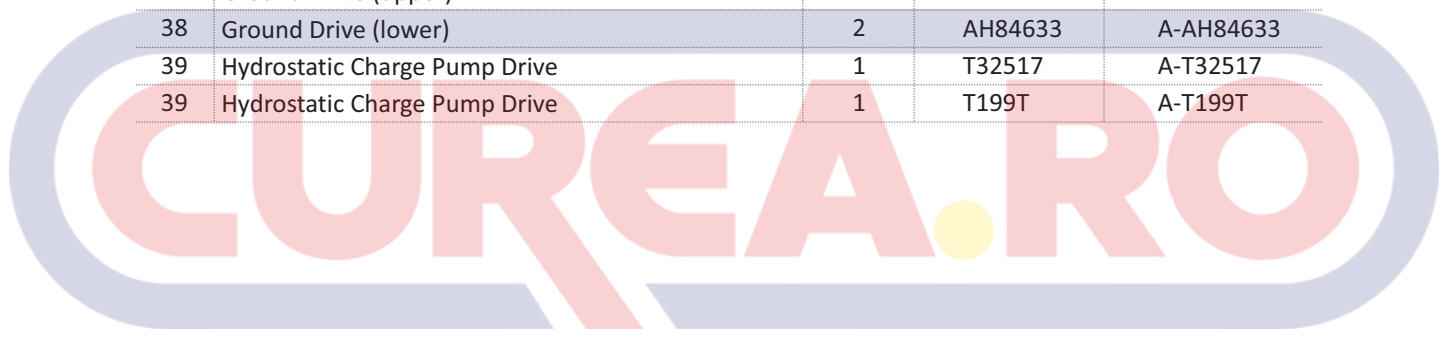

JOHN DEERE 7721

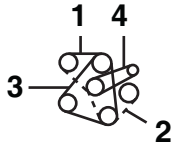

Engine

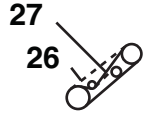

Long

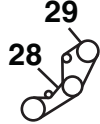

Sidehill



Variable





Reg. Fixed
Less Rev.

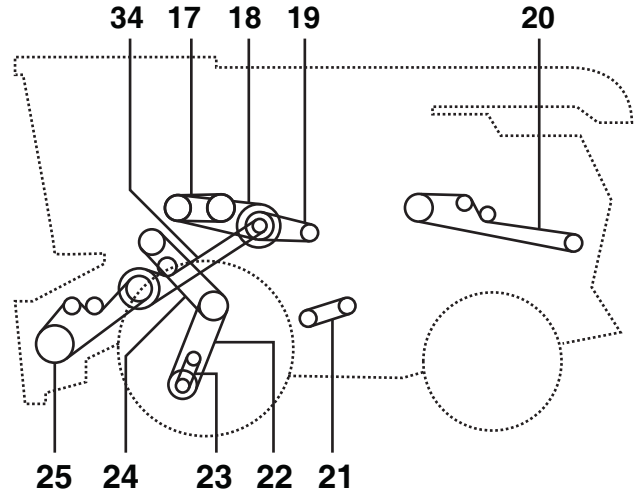
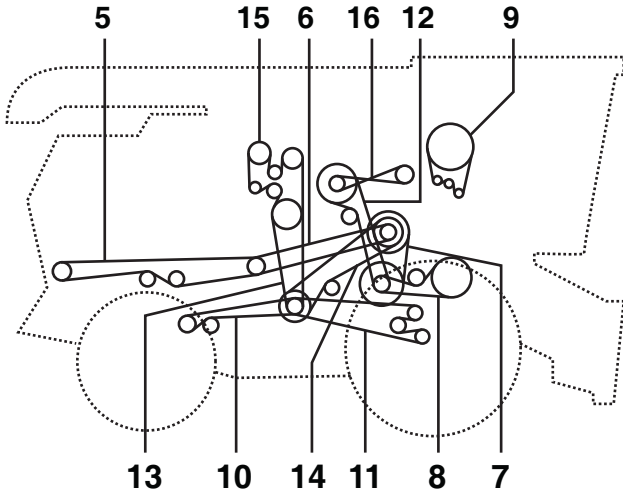

Reg. Fixed



| Belt No. | | No. of Belts | OEM  Part No. | PIX  Part No. |
|----------|--|--------------|--|--|
| 1 | Rear Straw Chopper Drive | 1 | H103344 | A-H103344 |
| 2 | Straw Chopper Drive | 1 | H101436 | A-H101436 |
| 3 | Countershaft Drive Torque Sensing | 1 | H113749 | A-H113749 |
| 4 | Standard Cylinder 4 Band (350 - 700 Rpm & 620 - 1240 Rpm) | 1 | H110375 | A-H110375 |
| 4 | Cylinder 4 Band (390 - 1030 Rpm Or 450 - 1200 Rpm) Optional Cylinder 4 Band | 1 | H96422 | A-H96422 |
| 4 | (280- 560 Rpm & 500 - 1000 Rpm) | 1 | H96422 | A-H96422 |
| 4 | Cylinder 4 Band (315 - 830 Rpm) | 1 | H96421 | A-H96421 |
| 5 | Tailings Auger Drive | 1 | H118730 | A-H118730 |
| 6 | Shoe Supply Auger Drive | 1 | H77010 | A-H77010 |
| 7 | Beater (100 % Beater Speed - Corn & Bean) | 1 | H96414 | A-H96414 |
| 7 | Beater (150 % Beater Speed - Grain & Rice) | 1 | H101469 | A-H101469 |
| 8 | Clean Grain Elevator Countershaft | 1 | H27433 | A-H27433 |
| 9 | Clean Grain Elevator, Loading Auger | 1 | H77766 | A-H77766 |
| 9 | Clean Grain Elevator, Loading Auger | 1 | H23950 | A-H23950 |
| 10 | Hydraulic Reel Pump Drive | 1 | H86274 | A-H86274 |
| 11 | Straw Spreader Drive | 1 | H112421 | A-H112421 |
| 12 | Cleaning Fan Drive | 1 | H108669 | A-H108669 |
| 13 | Feeder House Drive, Lower (regular Fixed) | 1 | H77765 | A-H77765 |
| 14 | Feeder House Conveyor Drive (regular Fixed) | 1 | H77766 | A-H77766 |
| 15 | Feeder House Drive | 1 | H76030 | A-H76030 |

JOHN DEERE 7722

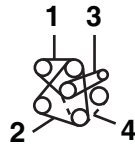

Engine





Long

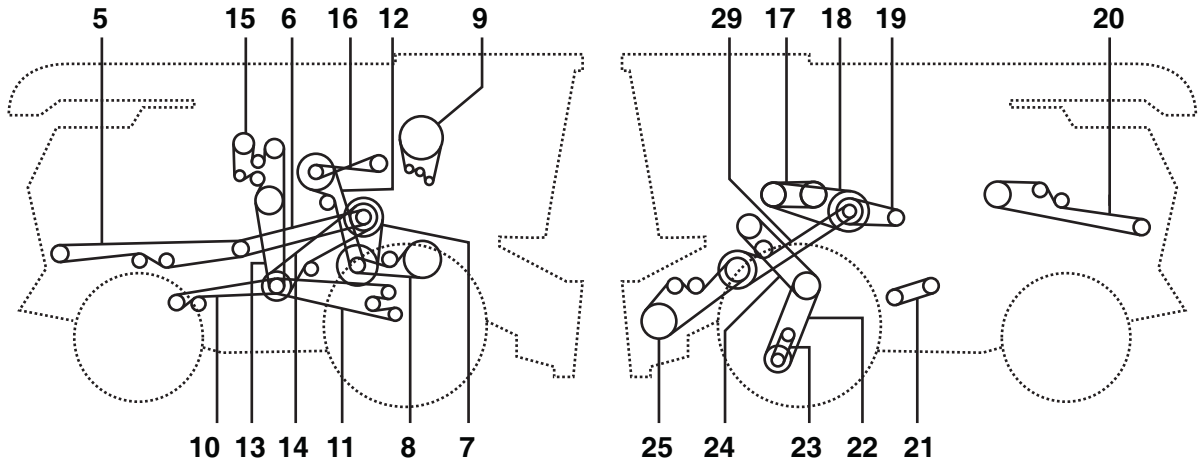

Variable

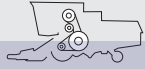

| Belt No. |  | No. of Belts | OEM  Part No. | PIX  Part No. |
|----------|---|--------------|--|--|
| 1 | ALTERNATOR & WATERPUMP | 1 | H86271 | A-H86271 |
| 2 | ROTARY SCREEN | 1 | H86273 | A-H86273 |
| 3 | COMPRESSOR | 1 | H122189 | A-H122189 |
| 4 | FAN & HYDRAULIC PUMP | 2 | AH96333 | A-AH96333 |
| 6 | HYDRO CHARGE PUMP | 1 | T32517 | A-T32517 |
| 7 | HYDRAULIC GROUND DRIVE, UPPER | 2 | AH84633 | A-AH84633 |
| 8 | FEEDER HOUSE DRIVE, LOWER | 1 | H111519 | A-H111519 |
| 9 | FEEDER HOUSE DRIVE, UPPER | 1 | H97929 | A-H97929 |
| 9 | FEEDER HOUSE DRIVE (LONG, REGULAR) | 1 | H23927 | A-H23927 |

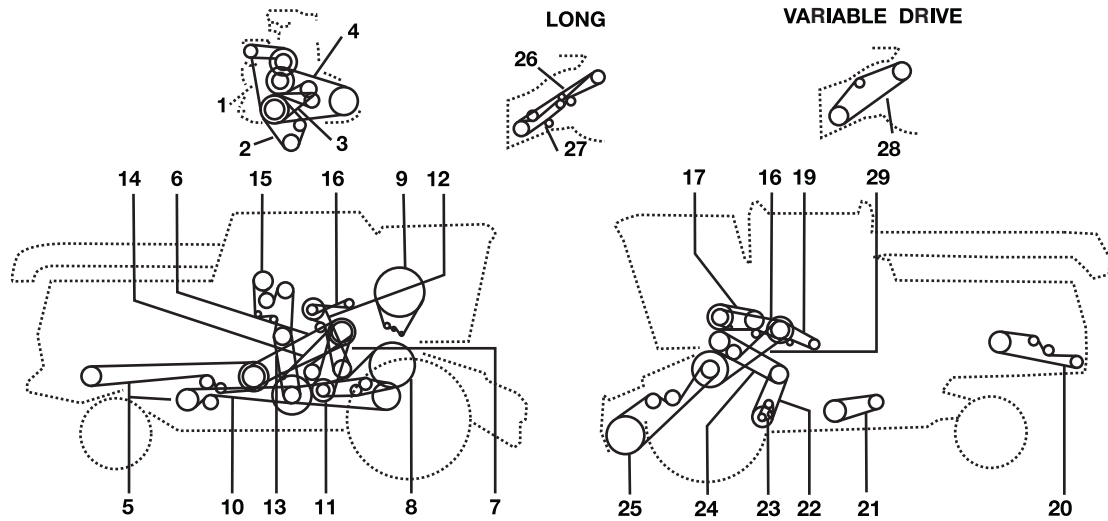

JOHN DEERE 8820

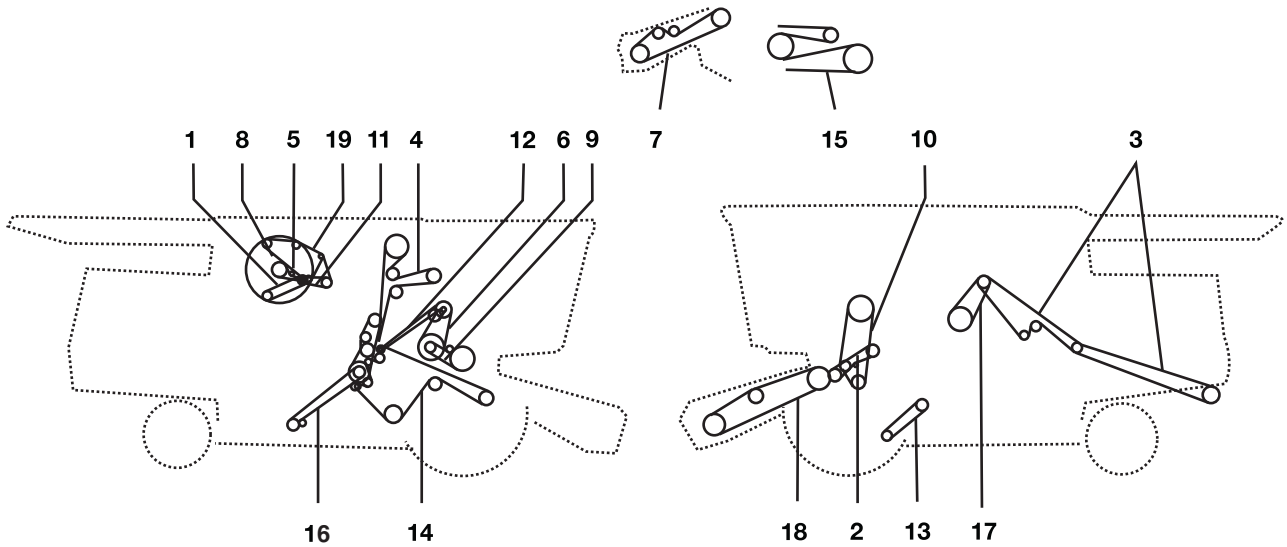

| Belt No. |  | No. of Belts | OEM  Part No. | PIX  Part No. |
|----------|---|--------------|--|--|
| 1 | Fan And Hydraulic Pump | 2 | AH96333 | A-AH96333 |
| 2 | Compressor Drive | 1 | R71603 | A-R71603 |
| 3 | Rotary Screen Drive | 1 | H86273 | A-H86273 |
| 4 | Alternator And Waterpump Drive | 1 | H79236 | A-H79236 |
| 4 | Alternator And Waterpump Drive | 1 | H86271 | A-H86271 |
| 5 | Rotary Screen Drive | 1 | H86259 | A-H86259 |
| 6 | Straw Chopper Drive (rear) | 1 | H103344 | A-H103344 |
| 7 | Straw Chopper Drive | 1 | H101436 | A-H101436 |
| 8 | Torque-sensing Countershaft Drive | 1 | H113749 | A-H113749 |
| 9 | Cylinder - (4-banded) (n=315-830 Rpm) | 1 | H96421 | A-H96421 |
| 9 | Cylinder - 4-banded (optional) | 1 | H96422 | A-H96422 |
| 9 | Cylinder - 4-banded (standard) | 1 | H110375 | A-H110375 |
| 10 | Clean Grain Elevator And Loading | 1 | H77766 | A-H77766 |
| 11 | Clean Grain Elevator Countershaft | 1 | H27433 | A-H27433 |
| 12 | Countershaft (secondary) | 1 | H81222 | A-H81222 |
| 12 | Countershaft (secondary) | 1 | H110300 | A-H110300 |
| 13 | Shoe Supply Augers | 1 | H77010 | A-H77010 |
| 14 | Tailings Auger Drive | 1 | H118730 | A-H118730 |
| 15 | Beater (100 % Beater Speed) | 1 | H96414 | A-H96414 |
| 15 | Beater (150 % Beater Speed) | 1 | H101469 | A-H101469 |
| 16 | Feeder House Drive | 1 | H76030 | A-H76030 |
| 17 | Feeder Conveyor Drive | 1 | H125380 | A-H125380 |
| 18 | Feeder House (lower) | 1 | H79796 | A-H79796 |
| 19 | Unloading Auger Drive | 2 | AH96300 | A-AH96300 |
| 20 | Feeder House Drive | 1 | H23927 | A-H23927 |
| 21 | Feeder House (lower) | 1 | H97929 | A-H97929 |
| 22 | Multi-groove Separator Drive | 1 | H108175 | A-H108175 |
| 23 | Feeder House Drive | 1 | H76030 | A-H76030 |
| 24 | Drive (lower) | 1 | H79796 | A-H79796 |
| 25 | Cleaning Fan Drive | 1 | H108669 | A-H108669 |
| 26 | Feeder House Drive Conveyor | 1 | H110921 | A-H110921 |
| 27 | Feeder House Drive | 1 | H23927 | A-H23927 |
| 28 | Straw Spreader (front) | 1 | H112421 | A-H112421 |
| 29 | Ground Drive (upper) | 2 | AH84633 | A-AH84633 |
| 30 | Ground Drive, Upper (sn -625400) | 1 | H86275 | A-H86275 |
| 30 | Ground Drive, Upper (sn 625401- 0) | 1 | H137207 | A-H137207 |
| 31 | Ground Drive (lower) | 2 | AH84633 | A-AH84633 |
| 32 | Hydrostatic Charge Pump Drive | 1 | T32517 | A-T32517 |

JOHN DEERE 9400



| Belt No. |  | No. of Belts | OEM  Part No. | PIX  Part No. |
|----------|---|--------------|--|--|
| 1 | Cooling Fan | 1 | H132809 | A-H132809 |
| 4 | Air Conditioning Compressor Drive | 1 | H134772 | A-H134772 |
| 5 | Clean Grain Elevator Drive | 1 | H137830 | A-H137830 |
| 6 | Cylinder Drive Intermediate | 1 | H115759 | A-H115759 |
| 6 | Clean Grain Elevator Drive | 1 | H141167 | A-H141167 |
| 6 | For Extended Range | 1 | H137670 | A-H137670 |
| 7 | Cylinder Drive,slow Speed | 1 | H118618 | A-H118618 |
| 7 | Cylinder Drive Regulardual Range | 1 | H115881 | A-H115881 |
| 8 | Tailings Auger Andelevator (lower) | 1 | N110085 | A-N110085 |
| 9 | For Alternator | 2 | H145026 | A-H145026 |
| 9 | For Alternator | 2 | RE44538 | A-RE44538 |
| 10 | Countershaft (secondary) | 1 | H128010 | A-H128010 |
| 11 | Straw Walker Shoe - Conveyor Augers | 1 | H131169 | A-H131169 |
| 12 | Unloading System | 1 | AH127866 | A-AH127866 |
| 13 | Short Rear | 1 | L4276N | A-L4276N |
| 13 | Long Rear | 1 | H101436 | A-H101436 |
| 13 | Straw Chopper Drive, Front | 1 | H125380 | A-H125380 |
| 14 | Regular | 1 | H140404 | A-H140404 |
| 14 | Slow Speed | 1 | H137264 | A-H137264 |
| 15 | Header And Reelpump | 1 | H125565 | A-H125565 |
| 15 | Header And Reelpump | 1 | H140160 | A-H140160 |
| 16 | Feeder Drive Variable Speed | 1 | H125711 | A-H125711 |
| 17 | Beater (75 % Beater Speed) | 1 | AH131960 | A-AH131960 |
| 17 | Beater (100 % Beater Speed) | 2 | AH139436 | A-AH139436 |
| 18 | Feeder House Fixed Speed With Reverser | 1 | H126345 | A-H126345 |
| 19 | Straw Spreaderdrive | 1 | Z33774 | A-Z33774 |

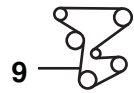

Late Model

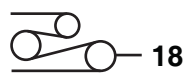



Straw Spreader



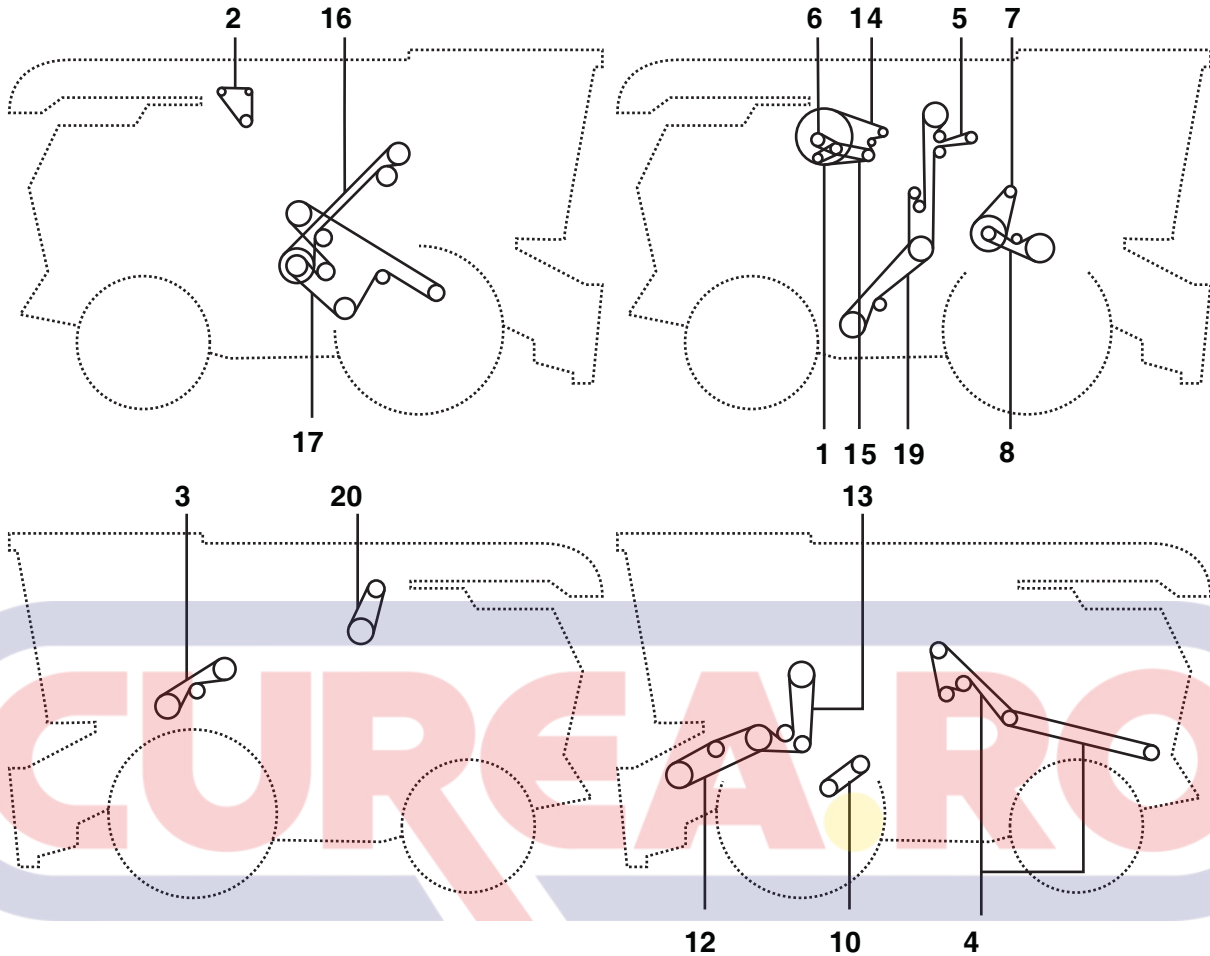

Feederhouse
Fixed W/Reverser



| Belt No. |  | No. of Belts | OEM  Part No. | PIX  Part No. |
|----------|---|--------------|--|--|
| 1 | Air Conditioning Compressor Drive | 1 | H80896 | A-H80896 |
| 2 | Air Flow Drive | 1 | H164452 | A-H164452 |
| 3 | Alternator, Engine | 2 | H101813 | A-H101813 |
| 4 | Beater Drive (75 %) | 2 | AH163931 | A-AH163931 |
| 5 | Beater Drive (100 %) | 2 | AH139436 | A-AH139436 |
| 6 | Chopper In Windrow Or Forward Position | 1 | H27433 | A-H27433 |
| 7 | Chopper In Rear (operating) Position | 1 | H101436 | A-H101436 |
| 8 | Clean Grain Elevator | 1 | H160171 | A-H160171 |
| 9 | Cooling Fan, Low Power | 1 | H132809 | A-H132809 |
| 10 | Cooling Fan, High Power | 1 | H132808 | A-H132808 |
| 11 | Cylinder Dr. Regular Dual Range & Single Range | 1 | H115881 | A-H115881 |
| 12 | Cylinder Intermediate Drive Belt | 1 | H210476 | A-H210476 |
| 13 | Engine Fan | 1 | H132808 | A-H132808 |
| 14 | Feeder House Variable Speed | 1 | H161648 | A-H161648 |
| 15 | Fixed Speed Feeder House With Reverser | 1 | H126345 | A-H126345 |
| 16 | For Extended Range | 1 | H137670 | A-H137670 |
| 17 | For Extended Range | 1 | H145994 | A-H145994 |

JOHN DEERE 9410

| Belt No. |  | No. of Belts | OEM  Part No. | PIX  Part No. |
|----------|---|--------------|--|--|
| 17 | For Extended Range | 1 | H145994 | A-H145994 |
| 18 | Header And Reelpump | 1 | H151952 | A-H151952 |
| 19 | Lower Tailings Auger & Elevator | 1 | N110085 | A-N110085 |
| 21 | Rotary Screen Drive | 1 | H146636 | A-H146636 |
| 22 | Secondary Countershaft | 1 | H128010 | A-H128010 |
| 23 | Shoe, Straw Walker & Conveyor Augers | 1 | H131169 | A-H131169 |
| 24 | Straw Chopper Drive, Front | 1 | H125380 | A-H125380 |
| 25 | Straw Chopper Drive, Regular | 1 | H140404 | A-H140404 |
| 26 | Straw Chopper Drive, Slow Speed | 1 | H137264 | A-H137264 |
| 27 | Straw Spreader | 1 | Z33774 | A-Z33774 |
| 28 | Unloading System | 2 | AH158880 | A-AH158880 |





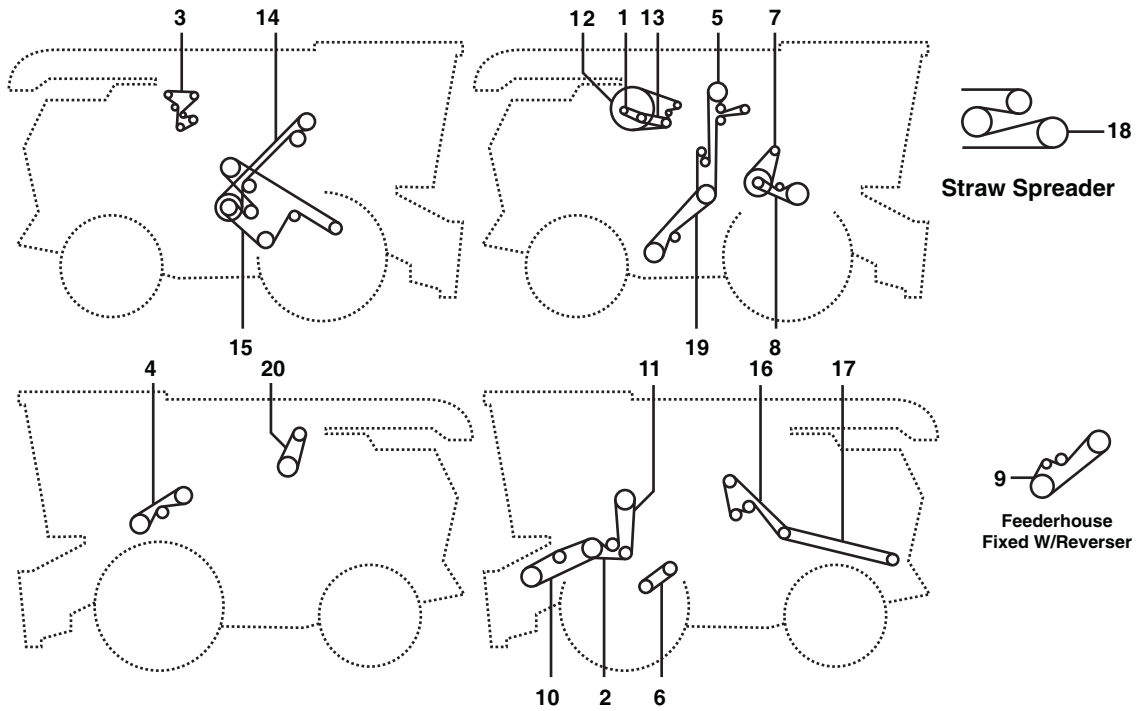

JOHN DEERE 9450

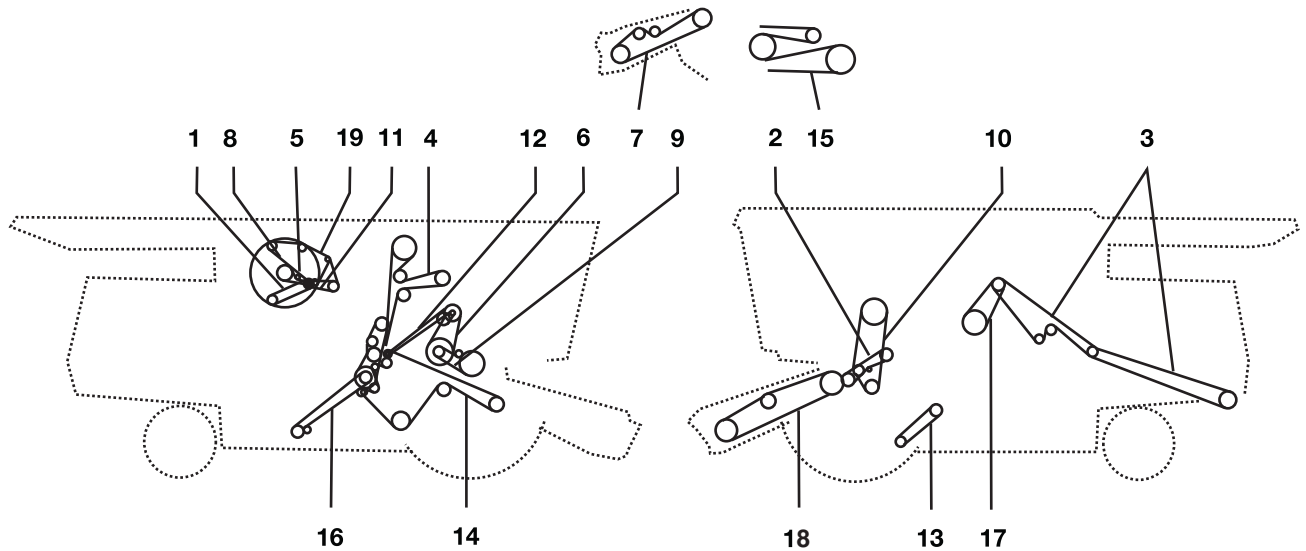

| Belt No. |  | No. of Belts | OEM  Part No. | PIX  Part No. |
|----------|---|--------------|--|--|
| 0 | Air Conditioning Compressor Drive | 1 | H101813 | A-H101813 |
| 1 | Cooling Fan | 1 | H132808 | A-H132808 |
| 2 | Air Flow Drive | 1 | H171386 | A-H171386 |
| 3 | Alternator (95 Amp) | 1 | H163515 | A-H163515 |
| 3 | Alternator (185 Amp) | 1 | H166870 | A-H166870 |
| 4 | Beater Drive (75%) | 2 | AH163931 | A-AH163931 |
| 4 | Beater Drive (100%) | 2 | AH139436 | A-AH139436 |
| 5 | Clean Grain Elevator | 1 | H141166 | A-H141166 |
| 6 | Cleaning Fan(750 - 1350 Rpm) | 1 | H152146 | A-H152146 |
| 6 | Cleaning Fan(490 - 980 Rpm) | 1 | H152180 | A-H152180 |
| 7 | Cylinder Intermediate Drive (150- 980rpm) | 1 | H210476 | A-H210476 |
| 7 | Cylinder Intermediate Drive (300- 1000rpm) | 1 | H137670 | A-H137670 |
| 8 | Cylinder Drive (240- 960 Rpm) (standard) | 1 | H115881 | A-H115881 |
| 8 | Cylinder Drive (extended Range) | 1 | H145994 | A-H145994 |
| 9 | Feeder House W/reverser Fixed Speed (-700101) | 1 | H126345 | A-H126345 |
| 9 | Feeder House W/reverser Fixed Speed (700101-) | 1 | H156796 | A-H156796 |
| 10 | Feeder House Variable Speed (-700100) | 1 | H161648 | A-H161648 |
| 10 | Feeder House Variable Speed (700101-) | 1 | H205167 | A-H205167 |
| 11 | Header And Reelpump (standard Capacity) | 1 | H151952 | A-H151952 |
| 12 | Rotary Screen (695101-) | 1 | H175632 | A-H175632 |
| 13 | Rotary Screen Drive | 1 | H146636 | A-H146636 |
| 14 | Countershaft Secondary | 1 | H128010 | A-H128010 |
| 15 | Shoe, Walker, And Convey Or Augers | 1 | H131169 | A-H131169 |
| 16 | Straw Chopper (front) | 1 | H157726 | A-H157726 |
| 17 | Straw Chopper (long Rear) | 1 | H101436 | A-H101436 |
| 17 | Straw Chopper (short Rear) | 1 | H27433 | A-H27433 |
| 18 | Straw Spreader | 1 | Z33774 | A-Z33774 |
| 19 | Tailings Auger & elevator, Lower | 1 | N110085 | A-N110085 |
| 20 | Unloading System | 2 | AH158880 | A-AH158880 |



JOHN DEERE 9500

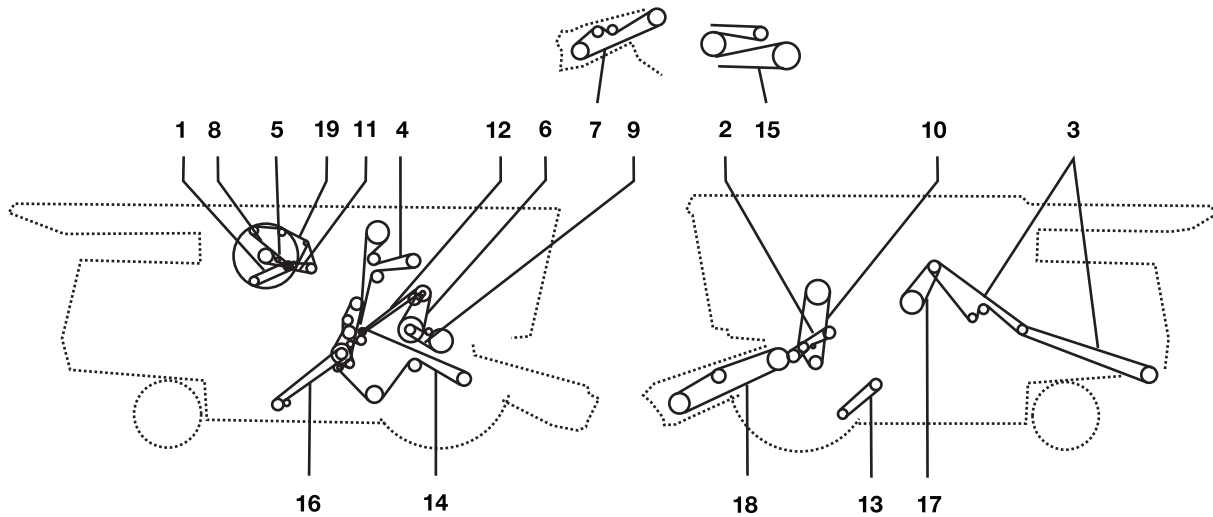

| Belt No. |  | No. of Belts | OEM  Part No. | PIX  Part No. |
|----------|---|--------------|--|--|
| 1 | Cooling Fan | 1 | H132808 | A-H132808 |
| 4 | Air Conditioning Compressor Drive | 1 | H134437 | A-H134437 |
| 5 | Clean Grain Elevator Drive | 1 | H137830 | A-H137830 |
| 5 | Clean Grain Elevator Drive | 1 | H141167 | A-H141167 |
| 6 | Cylinder Drive Intermediate | 1 | H115759 | A-H115759 |
| 6 | For Extended Range | 1 | H137670 | A-H137670 |
| 7 | Cylinder Drive, Slow Speed | 1 | H118618 | A-H118618 |
| 7 | Cylinder Drive Regular Dual Range | 1 | H115881 | A-H115881 |
| 8 | Tailings Auger And Elevator (lower) | 1 | N110085 | A-N110085 |
| 9 | For Alternator | 1 | H134344 | A-H134344 |
| 10 | Countershaft (secondary) | 1 | H128010 | A-H128010 |
| 11 | Straw Walker Shoe - Conveyor Augers | 1 | H131169 | A-H131169 |
| 12 | Unloading System | 1 | AH127866 | A-AH127866 |
| 13 | Short Rear | 1 | P47885 | A-P47885 |
| 13 | Long Rear | 1 | H125381 | A-H125381 |
| 13 | (front) | 1 | H125380 | A-H125380 |
| 14 | Regular | 1 | H140404 | A-H140404 |
| 14 | Slow Speed | 1 | H137264 | A-H137264 |
| 15 | Header And Reel Pump | 1 | H125565 | A-H125565 |
| 15 | Header And Reel Pump | 1 | H140160 | A-H140160 |
| 16 | Feeder Drive Variable Speed | 1 | H125711 | A-H125711 |
| 17 | Beater Optional (75 %) | 1 | AH131960 | A-AH131960 |
| 17 | Beater (100 % Beater Speed) | 2 | AH139436 | A-AH139436 |
| 18 | Feeder House Fixed Speed With Reverser | 1 | H126345 | A-H126345 |
| 19 | Straw Spreader Drive | 1 | H128234 | A-H128234 |

JOHN DEERE 9500 SIDE HILL

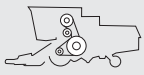

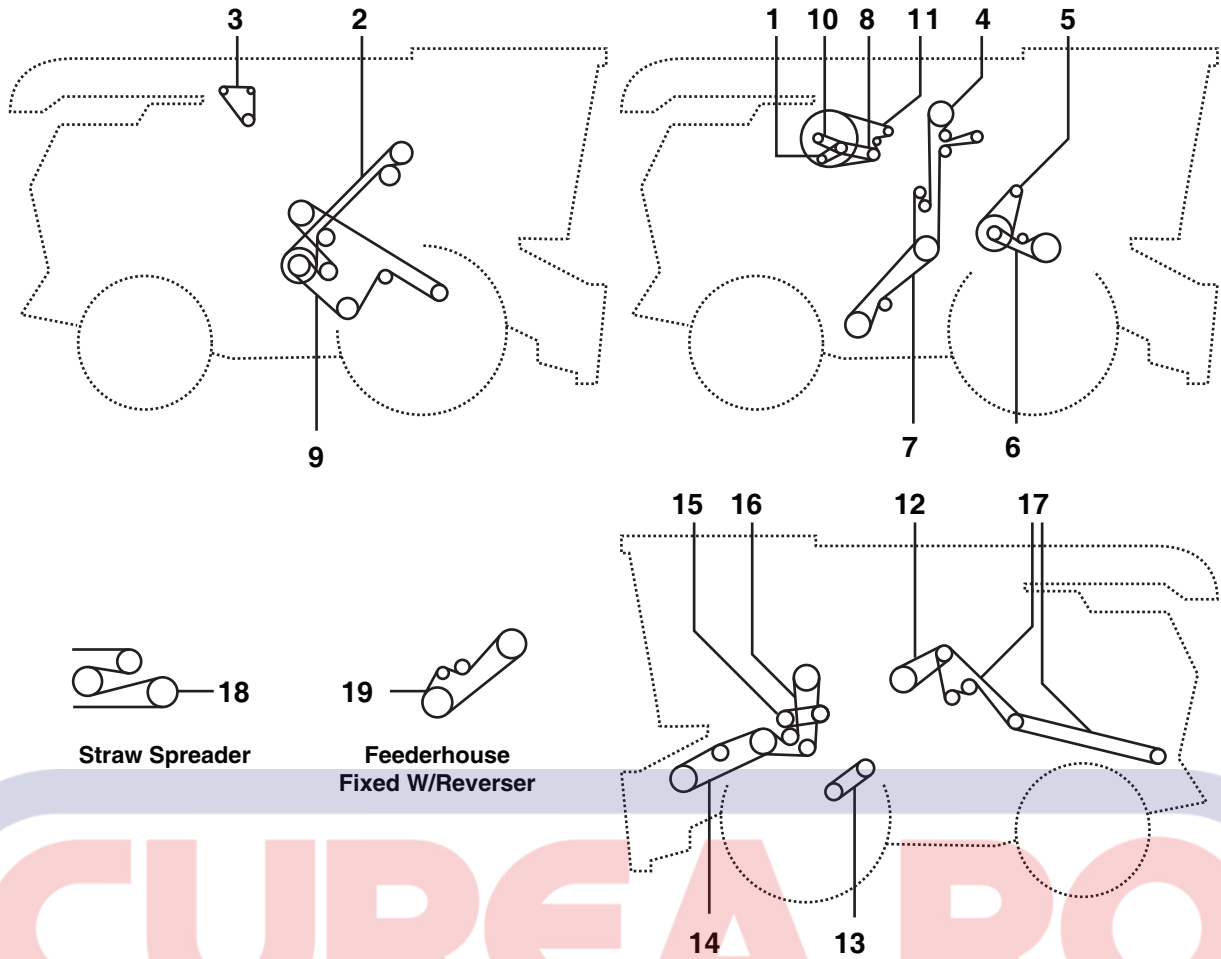

| Belt No. |  | No. of Belts | OEM  Part No. | PIX  Part No. |
|----------|---|--------------|--|--|
| 1 | Air Conditioning Compressor Drive | 1 | H81742 | A-H81742 |
| 1 | Air Conditioning Compressor Drive | 1 | H80896 | A-H80896 |
| 2 | Secondary Countershaft | 1 | H128010 | A-H128010 |
| 3 | Alternator | 1 | H101813 | A-H101813 |
| 3 | Alternator (low Power) | 1 | H134344 | A-H134344 |
| 3 | Alternator | 1 | R73189 | A-R73189 |
| 4 | Clean Grain Elevator | 1 | H137830 | A-H137830 |
| 4 | Clean Grain Elevator | 1 | H141167 | A-H141167 |
| 5 | Cylinder Intermediate Drive | 1 | H210476 | A-H210476 |
| 6 | Cylinder Drive (single& Dual Range) | 1 | H115881 | A-H115881 |
| 6 | Cylinder Drive (slow Speed) | 1 | H118618 | A-H118618 |
| 7 | Tailings Auger & elevator, Lower | 1 | N110085 | A-N110085 |
| 8 | Rotary Screen Drive | 1 | H146636 | A-H146636 |
| 9 | Shoe, Straw Walker And Conveyor Augers | 1 | H131169 | A-H131169 |
| 10 | Cooling Fan, High Power | 1 | H153297 | A-H153297 |
| 12 | Unloading System | 2 | AH158880 | A-AH158880 |
| 13 | Separator Fan, Slow Speed | 1 | H137264 | A-H137264 |
| 13 | Separator Fan, Slow Speed | 1 | H152180 | A-H152180 |
| 13 | Separator Fan, Regular speed | 1 | H140404 | A-H140404 |
| 13 | Separator Fan, Regular speed | 1 | H152146 | A-H152146 |
| 14 | Feeder House, Variable Speed | 1 | H161648 | A-H161648 |
| 15 | Beater Drive (75 % Beater Speed) | 2 | AH163931 | A-AH163931 |
| 15 | Beater Drive (100 % Beater Speed) | 2 | AH139436 | A-AH139436 |
| 16 | Header And Reel pump | 1 | H125565 | A-H125565 |
| 16 | Header And Reel pump | 1 | H151952 | A-H151952 |
| 17 | Front Chopper Drive | 1 | H125380 | A-H125380 |
| 17 | Chopper In Rear (operating) Position | 1 | H125381 | A-H125381 |
| 17 | Chopper In Windrow Or Forward Position | 1 | H23950 | A-H23950 |
| 17 | Chopper In Windrow Or Forward Position | 1 | P47885 | A-P47885 |
| 18 | Straw Spreader | 1 | H128234 | A-H128234 |
| 19 | Feeder house, Fixed With Reverser | 1 | H126345 | A-H126345 |

JOHN DEERE 9501



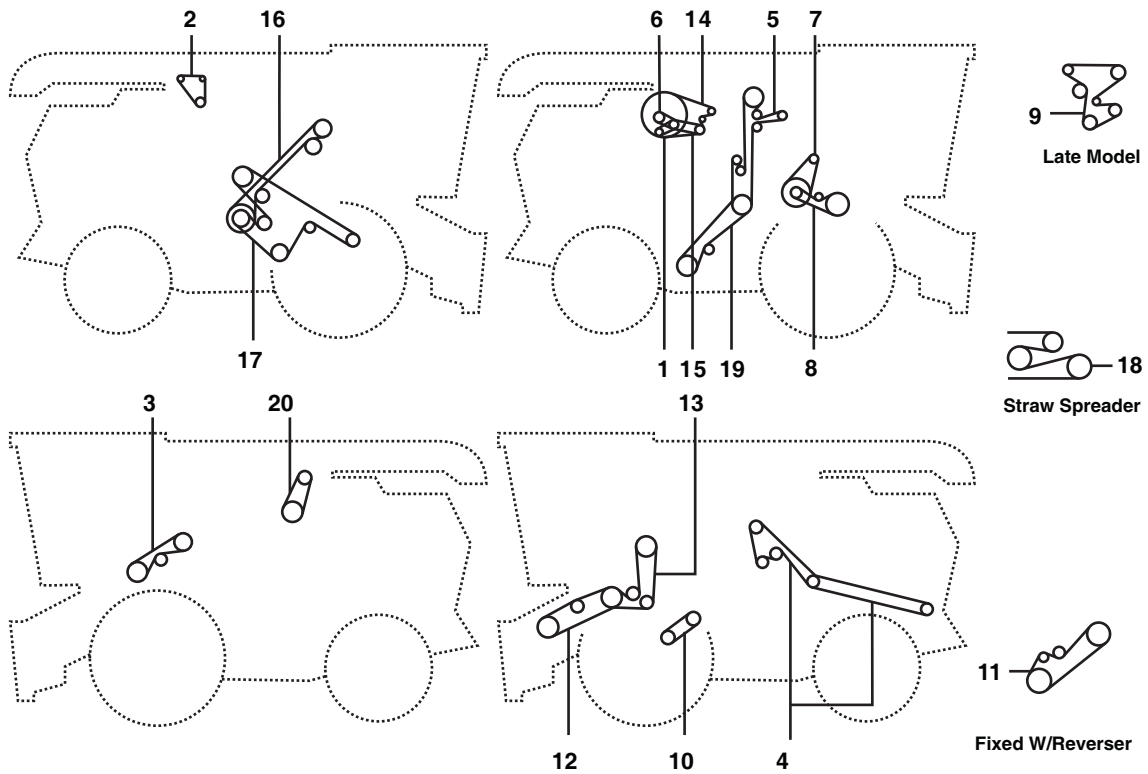

| Belt No. | | No. of Belts | OEM Part No. | PIX Part No. |
|----------|--|--------------|--------------|--------------|
| 1 | Secondary Countershaft | 1 | H128010 | A-H128010 |
| 2 | Clean Grain Elevator | 1 | H137830 | A-H137830 |
| 3 | Cylinder Intermediate Drive | 1 | H210476 | A-H210476 |
| 4 | Cylinder Drive Regular Dual & single Range | 1 | H115881 | A-H115881 |
| 5 | Tailings Auger & Elevator, Lower | 1 | N110085 | A-N110085 |
| 6 | Shoe, Straw Walker And Conveyor Augers | 1 | H131169 | A-H131169 |
| 7 | Unloading System | 2 | AH158880 | A-AH158880 |
| 8 | Separator Fan, Slow Speed | 1 | H137264 | A-H137264 |
| 8 | Separator Fan, Regular Speed | 1 | H140404 | A-H140404 |
| 9 | Beater Drive (100 % Beater Speed) | 2 | AH139436 | A-AH139436 |
| 10 | Header And Reel Pump | 1 | H151952 | A-H151952 |
| 11 | Front Chopper Drive | 1 | H125380 | A-H125380 |
| 11 | Rear Chopper, Long | 1 | H125381 | A-H125381 |
| 11 | Rear Chopper, Short | 1 | P47885 | A-P47885 |
| 12 | Straw Spreader | 1 | H128234 | A-H128234 |
| 13 | Feederhouse, Fixed With Reverser | 1 | H126345 | A-H126345 |



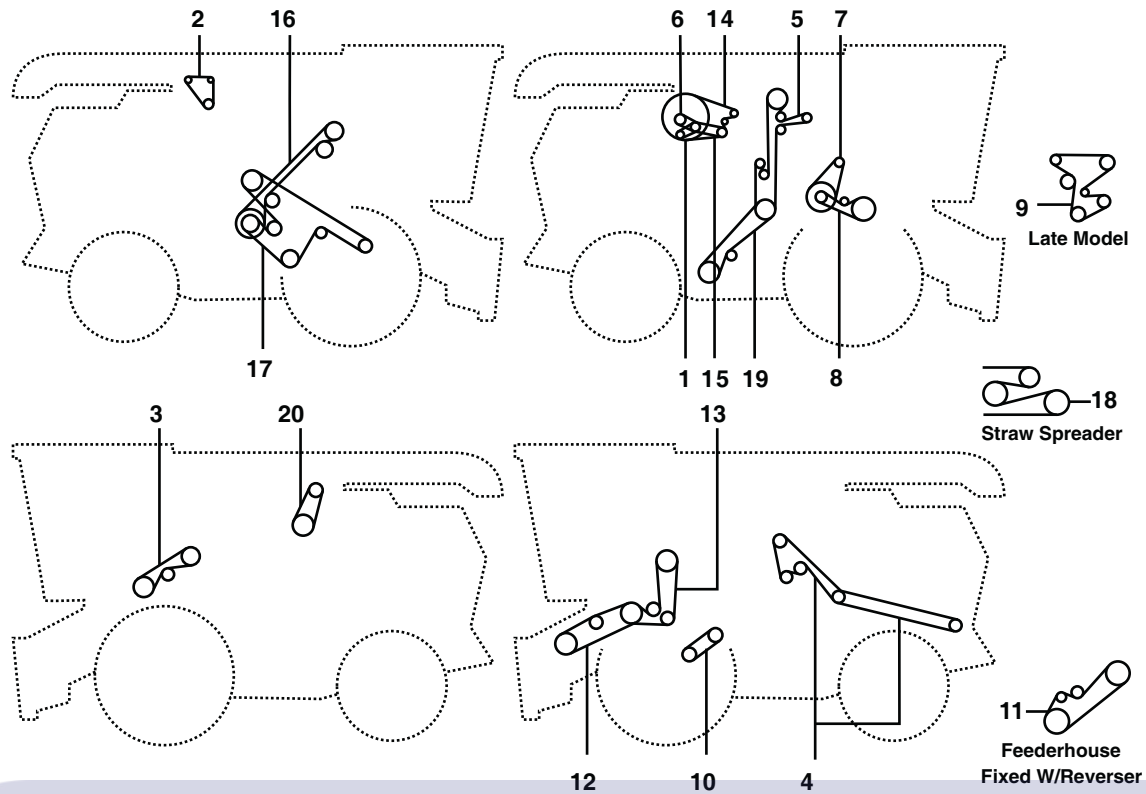

| Belt No. | | No. of Belts | OEM  Part No. | PIX  Part No. |
|----------|---|--------------|---|---|
| 1 | Air Conditioning Compressor Drive | 1 | H80896 | A-H80896 |
| 2 | Alternator | 1 | H101813 | A-H101813 |
| 3 | Beater Drive (75 %) | 2 | AH163931 | A-AH163931 |
| 3 | Beater Drive (100 %) | 2 | AH139436 | A-AH139436 |
| 4 | Chopper, Front | 1 | H125380 | A-H125380 |
| 4 | Chopper, Windrow or forward Position | 1 | H23950 | A-H23950 |
| 4 | Chopper, Rear Position | 1 | H125381 | A-H125381 |
| 5 | Clean Grain Elevator | 1 | H160171 | A-H160171 |
| 6 | Cooling Fan, High Power | 1 | H160405 | A-H160405 |
| 6 | Cooling Fan, Low Power | 1 | H161795 | A-H161795 |
| 6 | Cooling Fan, Low Power | 1 | H132808 | A-H132808 |
| 7 | Cylinder Intermediate Drive | 1 | H210476 | A-H210476 |
| 8 | Cylinder Drive, Regular Dual & Single Range | 1 | H115881 | A-H115881 |
| 8 | Cylinder Drive, Slow Speed | 1 | H118618 | A-H118618 |
| 9 | Fan Drive, Regularspeed | 1 | H152180 | A-H152180 |
| 9 | Fan Drive, Regularspeed | 1 | H152146 | A-H152146 |
| 10 | Feederhouse, Fixed Speed With Reverser | 1 | H126345 | A-H126345 |
| 11 | Feederhouse, Variable Speed | 1 | H161648 | A-H161648 |
| 12 | Powershift & Reel Pump, Header | 1 | H151952 | A-H151952 |
| 14 | Rotary Screen Drive | 1 | H146636 | A-H146636 |
| 15 | Secondary Countershaft | 1 | H128010 | A-H128010 |
| 16 | Shoe, Straw Walker & Conveyor Augers | 1 | H131169 | A-H131169 |
| 17 | Straw Spreader | 1 | H128234 | A-H128234 |
| 17 | Straw Spreader (deck Drive) | 1 | M140021 | A-M140021 |
| 18 | Tailings Auger & Elevator, Lower | 1 | N110085 | A-N110085 |
| 19 | Unloading System | 2 | AH158880 | A-AH158880 |

JOHN DEERE 9510 SIDE HILL



| Belt No. | | No. of Belts | OEM  Part No. | PIX  Part No. |
|----------|---|--------------|--|--|
| 1 | Air Conditioning Compressor Drive | 1 | H80896 | A-H80896 |
| 2 | Alternator | 1 | H101813 | A-H101813 |
| 3 | Beater Drive (75 %) | 2 | AH163931 | A-AH163931 |
| 3 | Beater Drive (100 %) | 2 | AH139436 | A-AH139436 |
| 4 | Chopper, Front | 1 | H125380 | A-H125380 |
| 4 | Chopper, Windrow Orforward Position | 1 | H23950 | A-H23950 |
| 4 | Chopper, Rear Operating Position | 1 | H125381 | A-H125381 |
| 5 | Clean Grain Elevator | 1 | H160171 | A-H160171 |
| 6 | Cooling Fan, High Power | 1 | H160405 | A-H160405 |
| 6 | Cooling Fan, Low Power | 1 | H161795 | A-H161795 |
| 6 | Cooling Fan, Low Power | 1 | H132808 | A-H132808 |
| 7 | Cylinder Intermediate Drive | 1 | H210476 | A-H210476 |
| 8 | Cylinder Drive, Regular Dual & Single Range | 1 | H115881 | A-H115881 |
| 8 | Cylinder Drive, Slow Speed | 1 | H118618 | A-H118618 |
| 9 | Fan Drive, Slow Speed | 1 | H152180 | A-H152180 |
| 9 | Fan Drive, Regularspeed | 1 | H152146 | A-H152146 |
| 10 | Feederhouse, Fixed Speed With Reverser | 1 | H126345 | A-H126345 |
| 11 | Feederhouse, Variable Speed | 1 | H161648 | A-H161648 |
| 12 | Powershift & Reel Pump, Header | 1 | H151952 | A-H151952 |
| 14 | Rotary Screen Drive | 1 | H146636 | A-H146636 |
| 15 | Secondary Countershaft | 1 | H128010 | A-H128010 |
| 16 | Shoe, Straw Walker & Conveyor Augers | 1 | H131169 | A-H131169 |
| 17 | Straw Spreader | 1 | H128234 | A-H128234 |
| 17 | Straw Spreader (deck Drive) | 1 | M140021 | A-M140021 |
| 18 | Tailings Auger & Elevator, Lower | 1 | N110085 | A-N110085 |
| 20 | Unloading System | 2 | AH158880 | A-AH158880 |



JOHN DEERE 9540 - 9560 - 9580 (EUROPE)

| Belt No. |  | No. of Belts | OEM  Part No. | PIX  Part No. |
|----------|---|--------------|--|--|
| 1 | - | 1 | H175632 | A-H175632 |
| 2 | - | 1 | H115881 | A-H115881 |
| 3 | - | 1 | H177263 | A-H177263 |
| 4 | - | 1 | N110085 | A-N110085 |
| 5 | - | 1 | H175742 | A-H175742 |
| 6 | 9540 | 1 | H177589 | A-H177589 |
| 6 | 9560 / 9580 | 1 | H146636 | A-H146636 |
| 7 | 9540 | 1 | H175467 | A-H175467 |
| 7 | 9560 / 9580 | 1 | H177186 | A-H177186 |
| 8 | - | 1 | H176765 | A-H176765 |
| 10 | - | 1 | H177177 | A-H177177 |
| 11 | - | 1 | H152146 | A-H152146 |
| 12 | - | 1 | H176766 | A-H176766 |
| 13 | For Hillmaster Only | 1 | H202821 | A-H202821 |
| 16 | - | 2 | AH139436 | A-AH139436 |
| 17 | - | 2 | AH158880 | A-AH158880 |

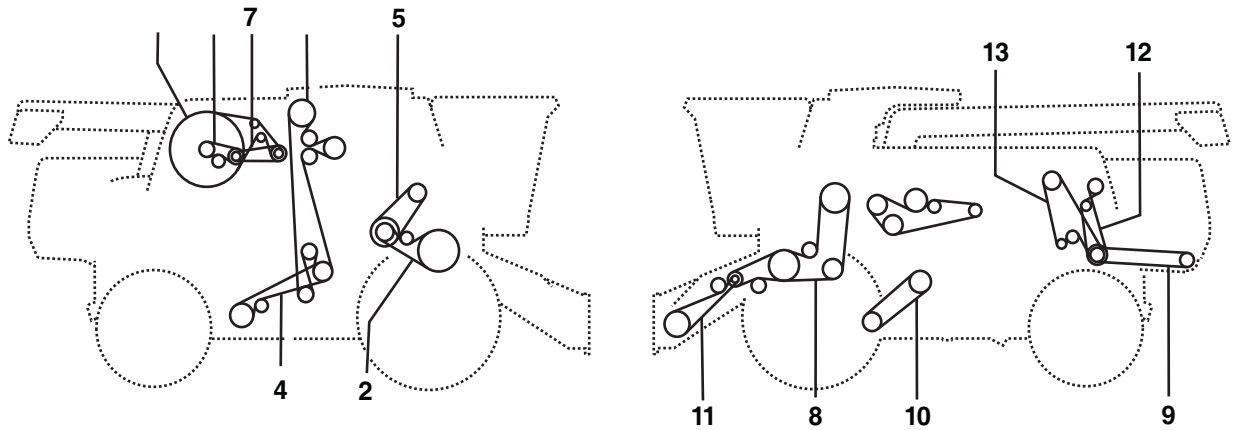

JOHN DEERE 9540 (I) WTS - 9560(I) WTS - 9580(i)WTS

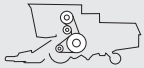

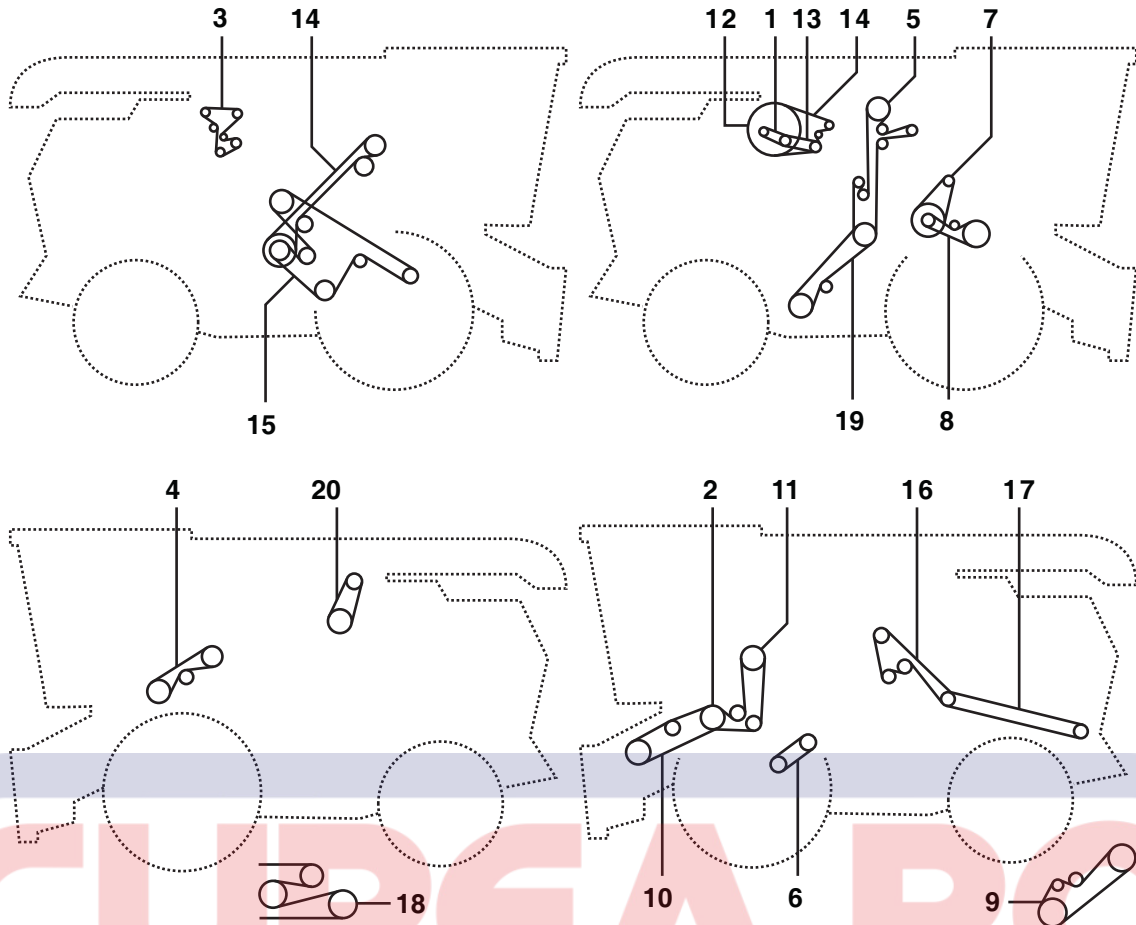

| Belt No. |  | No. of Belts | OEM  Part No. | PIX  Part No. |
|----------|---|--------------|--|--|
| 1 | - | 1 | H175632 | A-H175632 |
| 2 | - | 1 | H115881 | A-H115881 |
| 3 | (SUB FOR H177263) | 1 | HXE51300 | A-HXE51300 |
| 4 | - | 1 | N110085 | A-N110085 |
| 5 | (SUB FOR H210476) | 1 | HXE51101 | A-HXE51101 |
| 6 | (9540) | 1 | H175467 | A-H175467 |
| 6 | (9560 - 9580) | 1 | H177186 | A-H177186 |
| 7 | (9540) | 1 | H177589 | A-H177589 |
| 7 | (9560 - 9580) | 1 | H146636 | A-H146636 |
| 8 | - | 1 | H176765 | A-H176765 |
| 8 | - | 1 | H177383 | A-H177383 |
| 9 | - | 1 | H177442 | A-H177442 |
| 9 | - | 1 | H177178 | A-H177178 |
| 9 | - | 1 | Z59286 | A-Z59286 |
| 10 | - | 1 | H152146 | A-H152146 |
| 10 | - | 1 | H152180 | A-H152180 |
| 11 | - | 1 | H176766 | A-H176766 |
| 11 | - | 1 | H202821 | A-H202821 |
| 11 | - | 1 | H176882 | A-H176882 |
| 11 | - | 1 | Z56959 | A-Z56959 |
| 12 | - | 1 | Z73879 | A-Z73879 |
| 12 | - | 1 | Z78834 | A-Z78834 |
| 13 | - | 1 | H177177 | A-H177177 |



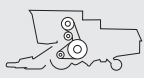

| Belt No. | Straw Spreader | No. of Belts | OEM Part No. | PIX Part No. |
|----------|----------------|--------------|--------------|--------------|
| 1 | | 1 | H160405 | A-H160405 |
| 2 | | 1 | H171386 | A-H171386 |
| 3 | | 1 | H163515 | A-H163515 |
| 3 | | 1 | H166870 | A-H166870 |
| 4 | | 2 | AH163931 | A-AH163931 |
| 4 | | 2 | AH139436 | A-AH139436 |
| 5 | | 1 | H141166 | A-H141166 |
| 6 | | 1 | H152180 | A-H152180 |
| 6 | | 1 | H152146 | A-H152146 |
| 7 | | 1 | H210476 | A-H210476 |
| 7 | | 1 | H137670 | A-H137670 |
| 8 | | 1 | H115881 | A-H115881 |
| 8 | | 1 | H118618 | A-H118618 |
| 9 | | 1 | H126345 | A-H126345 |
| 9 | | 1 | H126345 | A-H126345 |
| 9 | | 1 | H156796 | A-H156796 |
| 9 | | 1 | H156796 | A-H156796 |

JOHN DEERE 9550 - 9550 SIDE HILL

| Belt No. |  | No. of Belts | OEM  Part No. | PIX  Part No. |
|----------|---|--------------|--|--|
| 10 | Feederhouse, Variable Speed (ser. Nr Till 700200) (9550) | 1 | H161648 | A-H161648 |
| 10 | Feederhouse, Variable Speed (ser. Nr Till 700700) (9550 Side Hill) | 1 | H161648 | A-H161648 |
| 10 | Feederhouse, Variable Speed (ser. Nr From 700201) (9550) | 1 | H205167 | A-H205167 |
| 10 | Feederhouse, Variable Speed (ser. Nr From 700701) (9550 Side Hill) | 1 | H205167 | A-H205167 |
| 10 | Feederhouse, Variable Speed (high Capacity) (9550) | 1 | H218728 | A-H218728 |
| 11 | Header & Reel Pump (standard Capacity) | 1 | H151952 | A-H151952 |
| 11 | Header & Reel Pump (high Capacity) (9550) | 1 | H155998 | A-H155998 |
| 12 | Rotary Screen (ser. Nr From 690701) | 1 | H175632 | A-H175632 |
| 13 | Rotary Screen Drive (ser. Nr Till 700200) | 1 | H160406 | A-H160406 |
| 13 | Rotary Screen Drive (ser. Nr From 700201) | 1 | H177589 | A-H177589 |
| 14 | Secondary Countershaft | 1 | H128010 | A-H128010 |
| 15 | Shoe, Walker & Conveyor Augers | 1 | H131169 | A-H131169 |
| 16 | Straw Chopper, Front | 1 | H157726 | A-H157726 |
| 17 | Straw Chopper (fine Cut) | 1 | H175434 | A-H175434 |
| 17 | Straw Chopper (standard) | 1 | H160654 | A-H160654 |
| 17 | Straw Chopper (standard Baling) | 1 | H23950 | A-H23950 |
| 17 | Straw Chopper (fine Cut Baling) | 1 | H22529 | A-H22529 |
| 18 | Straw Spreader | 1 | H128234 | A-H128234 |
| 19 | Tailings Auger & Elevator, Lower | 1 | N110085 | A-N110085 |
| 20 | Unloading System | 2 | AH158880 | A-AH158880 |

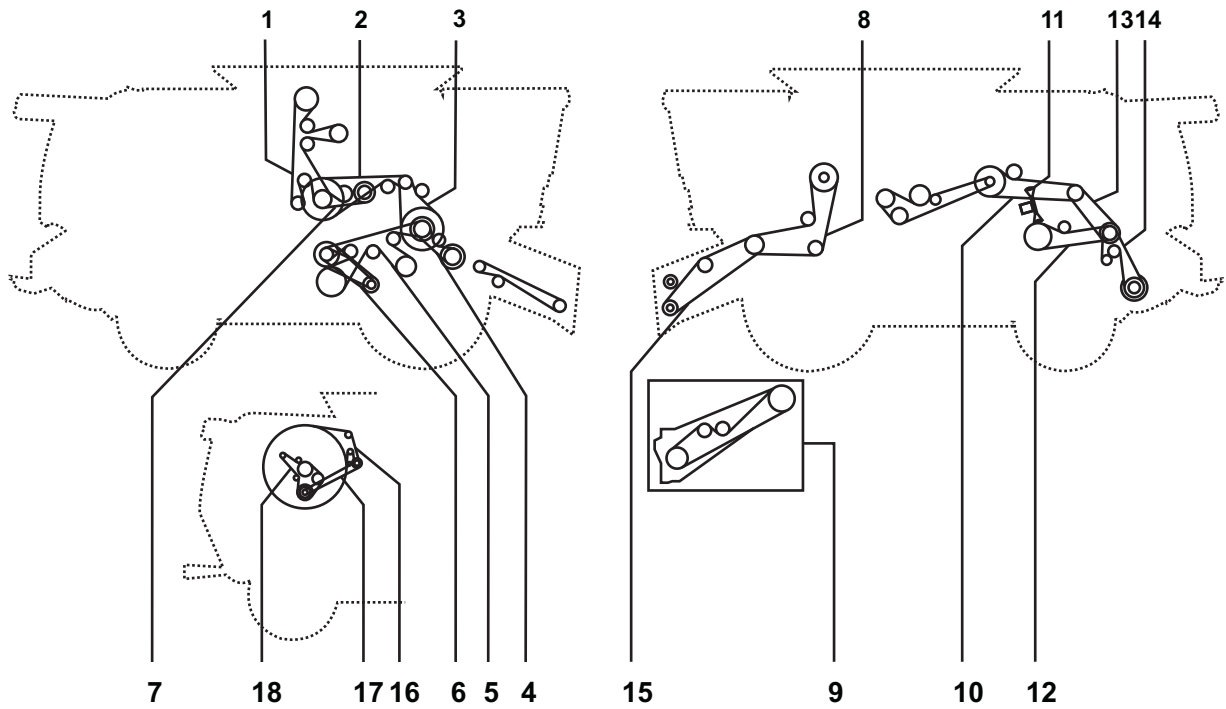

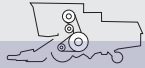
JOHN DEERE 9560 STS





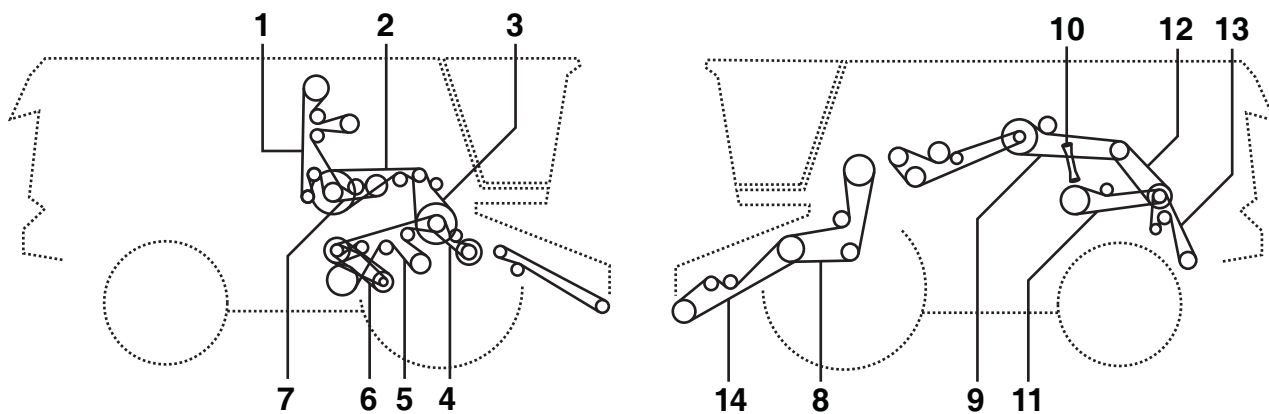

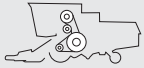
| Belt No. |  | No. of Belts | OEM  Part No. | PIX  Part No. |
|----------|---|--------------|--|--|
| 1 | Clean Grain Elevator Drive | 1 | H218645 | A-H218645 |
| 2 | Jackshaft - Right Hand (rear) | 1 | H154723 | A-H154723 |
| 3 | Jackshaft - (front) Right Hand | 2 | AH202773 | A-AH202773 |
| 4 | Feeder Accelerator - Standard Speed (serial Nr. 715301 - ...) | 1 | H211581 | A-H211581 |
| 4 | Feeder Accelerator - Standard Speed (serial Nr. ... - 715300) | 1 | H221731 | A-H221731 |
| 4 | Feeder Accelerator - Low Speed | 1 | H221732 | A-H221732 |
| 5 | Shoe Fan And Conveyor Augers | 1 | H175587 | A-H175587 |
| 6 | Cleaning Fan Drive | 1 | H206048 | A-H206048 |
| 6 | Cleaning Fan - Slow Speed (sub Forh206049) | 1 | H211601 | A-H211601 |
| 7 | Tailings Auger And Elevator | 1 | H154731 | A-H154731 |
| 8 | Header And Reel Pump (standard Capacity) | 1 | H126345 | A-H126345 |
| 8 | Header And Reel Pump (high Capacity) | 1 | H209507 | A-H209507 |
| 9 | Feeder House Fixed Speed | 1 | H126345 | A-H126345 |
| 10 | Unloading Auger Drive | 2 | AH160080 | A-AH160080 |
| 11 | Rotor Variator Drive | 1 | H169449 | A-H169449 |
| 12 | Discharge Beater Drive | 1 | H168301 | A-H168301 |
| 13 | Countershaft - Discharge Beater Andchopper | 1 | H157514 | A-H157514 |
| 14 | Straw Chopper Drive | 1 | H204747 | A-H204747 |
| 15 | Feeder House Variable Drive (standard Capacity) | 1 | H201334 | A-H201334 |
| 15 | Feeder House Variable Drive (high Capacity) | 1 | H218726 | A-H218726 |
| 16 | Rotary Screen Drive - Screen Side | 1 | H175632 | A-H175632 |
| 17 | Rotary Screen Drive - Engine Side | 1 | H201498 | A-H201498 |
| 18 | Alternator Drive (95 Amp) | 1 | R135606 | A-R135606 |
| 18 | Alternator Drive (185 Amp) | 1 | R135609 | A-R135609 |

JOHN DEERE 9560i STS

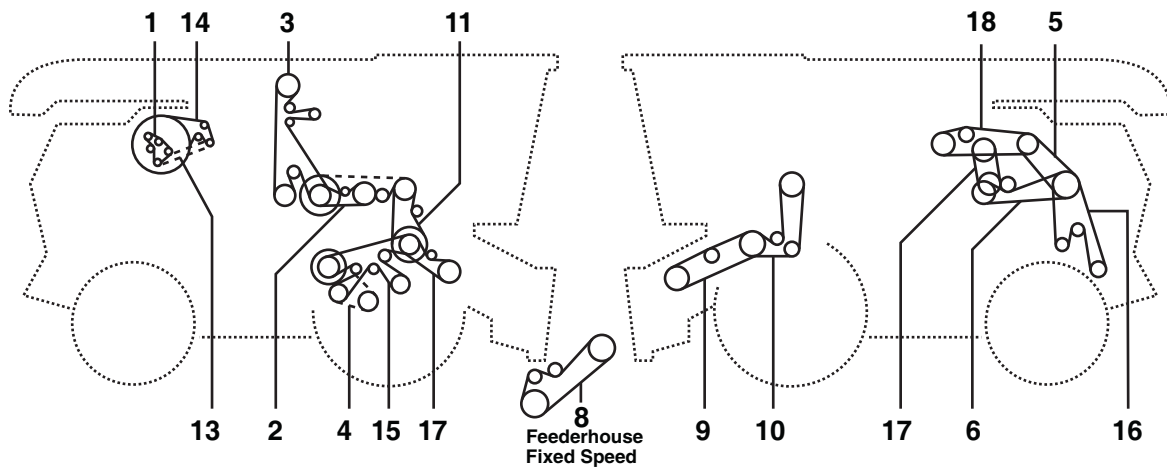



| Belt No. |  | No. of Belts | OEM  Part No. | PIX  Part No. |
|----------|---|--------------|--|--|
| 1 | - | 1 | H218645 | A-H218645 |
| 2 | - | 1 | H154723 | A-H154723 |
| 3 | - | 2 | AH150678 | A-AH150678 |
| 4 | - | 1 | H221733 | A-H221733 |
| 4 | - | 1 | H221732 | A-H221732 |
| 5 | - | 1 | H175587 | A-H175587 |
| 6 | CLEANING FAN DRIVE | 1 | H206048 | A-H206048 |
| 7 | - | 1 | H154731 | A-H154731 |
| 8 | HEADER AND REEL PUMP (HIGH CAPACITY) | 1 | H209507 | A-H209507 |
| 9 | UNLOADING AUGER DRIVE | 2 | AH160080 | A-AH160080 |
| 10 | - | 1 | H221498 | A-H221498 |
| 11 | DISCHARGE BEATER DRIVE | 1 | H168301 | A-H168301 |
| 12 | - | 1 | HXE15671 | A-HXE15671 |
| 13 | - | 1 | H235564 | A-H235564 |
| 14 | - | 1 | H174885 | A-H174885 |





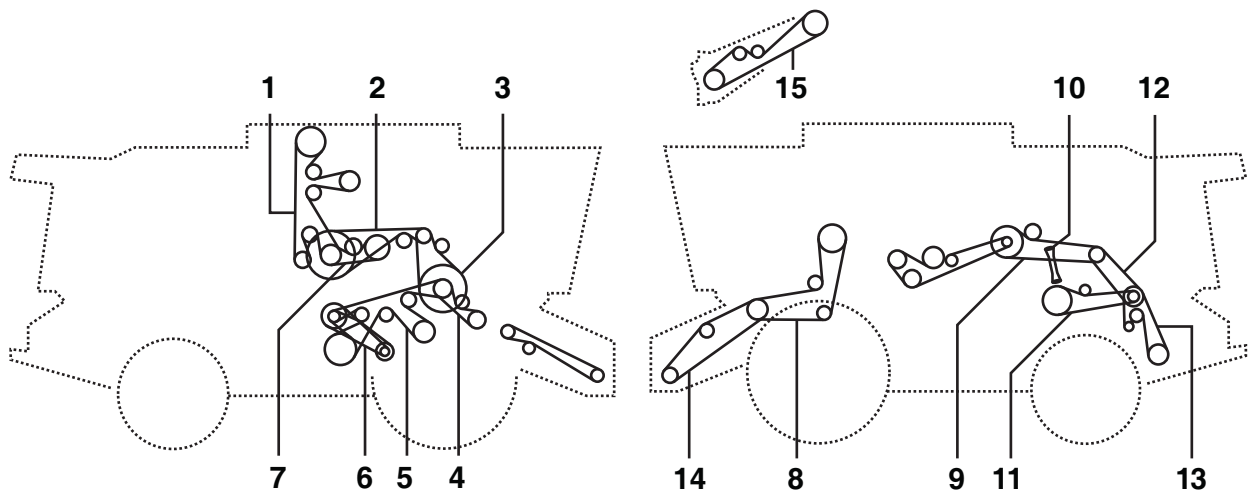

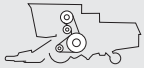
| Belt No. |  | No. of Belts | OEM  Part No. | PIX  Part No. |
|----------|---|--------------|--|--|
| 1 | Tailings Auger & elevator | 1 | H154731 | A-H154731 |
| 2 | Clean Grain Elevator | 1 | H218645 | A-H218645 |
| 3 | Cleaning Fan | 1 | H230909 | A-H230909 |
| 3 | Cleaning Fan (slow Speed) | 1 | H215389 | A-H215389 |
| 4 | Countershaft, Discharge Beater And Chopper | 1 | H157514 | A-H157514 |
| 4 | Subs Forh157514 | 1 | HXE15671 | A-HXE15671 |
| 5 | Discharge Beater | 1 | H219182 | A-H219182 |
| 6 | Feed Accelerator (standard Speed) | 1 | H236472 | A-H236472 |
| 6 | Feed Accelerator (slow Speed) | 1 | H221732 | A-H221732 |
| 7 | Feederhouse, Fixed Speed | 1 | H203474 | A-H203474 |
| 8 | Feederhouse, Variable Speed. Standard Capacity | 1 | H201334 | A-H201334 |
| 8 | Feederhouse, Variable Speed. High Capacity | 1 | H218726 | A-H218726 |
| 9 | Header And Reelpump, Standard capacity | 1 | H126345 | A-H126345 |
| 9 | Header And Reelpump, High Capacity | 1 | H209507 | A-H209507 |
| 10 | Right Hand Jackshaft (front) | 2 | AH202773 | A-AH202773 |
| 11 | Right Hand Jackshaft (rear) | 1 | H154723 | A-H154723 |
| 12 | Shoe Fan & Conveyor Augers | 1 | H175587 | A-H175587 |
| 13 | Variable Rotor Drive | 1 | H221498 | A-H221498 |
| 14 | Unloading Auger System | 2 | AH160080 | A-AH160080 |

JOHN DEERE 9570 STS - NA EDITION

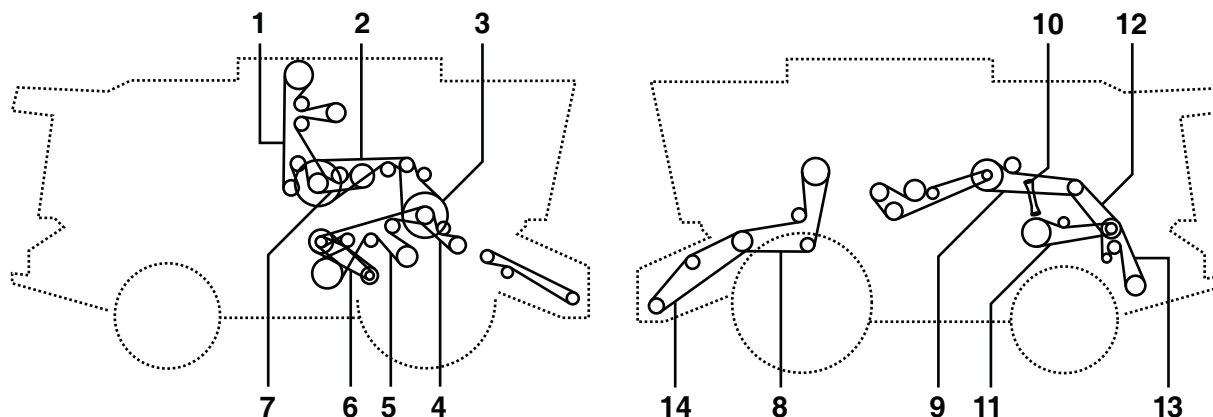



| Belt No. |  | No. of Belts | OEM  Part No. | PIX  Part No. |
|----------|---|--------------|--|--|
| 1 | Clean Grain Elevator Drive | 1 | H218645 | A-H218645 |
| 2 | Jackshaft - Right Hand (rear) | 1 | H154723 | A-H154723 |
| 3 | Jackshaft - Right Hand (front) | 2 | AH202773 | A-AH202773 |
| 4 | Feeder Accelerator - Standard Speed | 1 | H236472 | A-H236472 |
| 4 | Feeder Accelerator - Low Speed | 1 | H221732 | A-H221732 |
| 5 | Shoe Fan And Conveyor Augers | 1 | H175587 | A-H175587 |
| 6 | Cleaning Fan Drive | 1 | H230909 | A-H230909 |
| 6 | Cleaning Fan - Slow Speed | 1 | H215389 | A-H215389 |
| 7 | Tailings Auger And Elevator | 1 | H154731 | A-H154731 |
| 8 | Header And Reel Pump (standard Capacity) | 1 | H126345 | A-H126345 |
| 8 | Header And Reel Pump (high Capacity) | 1 | H209507 | A-H209507 |
| 9 | Unloading Auger Drive | 2 | AH160080 | A-AH160080 |
| 10 | Rotor Variator Drive | 1 | H221498 | A-H221498 |
| 11 | Discharge Beater Drive | 1 | H219182 | A-H219182 |
| 12 | Countershaft - Beater And Chopper (standard Capacity) | 1 | HXE15671 | A-HXE15671 |
| 13 | Straw Chopper Drive | 1 | H235564 | A-H235564 |
| 14 | Feeder House Variable Drive (standard Capacity) | 1 | H201334 | A-H201334 |
| 14 | Feeder House Variable Drive (high Capacity) | 1 | H218726 | A-H218726 |
| 15 | Feeder House Fixed Speed | 1 | H203474 | A-H203474 |
| x | Alternator Drive (200 Amp) | 1 | R521053 | A-R521053 |



| Belt No. |  | No. of Belts | OEM  Part No. | PIX  Part No. |
|----------|---|--------------|--|--|
| 1 | Clean Grain Elevator Drive | 1 | H218645 | A-H218645 |
| 2 | Jackshaft - Right Hand (rear) | 1 | H154723 | A-H154723 |
| 3 | Jackshaft - Right Hand (front) | 2 | AH202773 | A-AH202773 |
| 4 | Feeder Accelerator - Standard Speed | 1 | H211581 | A-H211581 |
| 5 | Shoe Fan And conveyor Augers | 1 | H175587 | A-H175587 |
| 6 | Cleaning Fandrive | 1 | H230909 | A-H230909 |
| 6 | Cleaning Fan- Slow Speed | 1 | H215389 | A-H215389 |
| 7 | Tailings Auger And elevator | 1 | H154731 | A-H154731 |
| 8 | Header And Reelpump (high Capacity) | 1 | H209507 | A-H209507 |
| 9 | Unloading Auger Drive | 2 | AH160080 | A-AH160080 |
| 10 | Rotor Variator Drive | 1 | H221498 | A-H221498 |
| 11 | Discharge Beater Drive | 1 | H219182 | A-H219182 |
| 12 | Countershaft - Beater & Chopper (standard capacity) | 1 | H157514 | A-H157514 |
| 13 | Straw Chopper Drive | 1 | H204747 | A-H204747 |
| 14 | Feeder House Variable Drive (high Capacity) | 1 | H218726 | A-H218726 |
| x | Alternator Drive (200 Amp) | 1 | R521053 | A-R521053 |

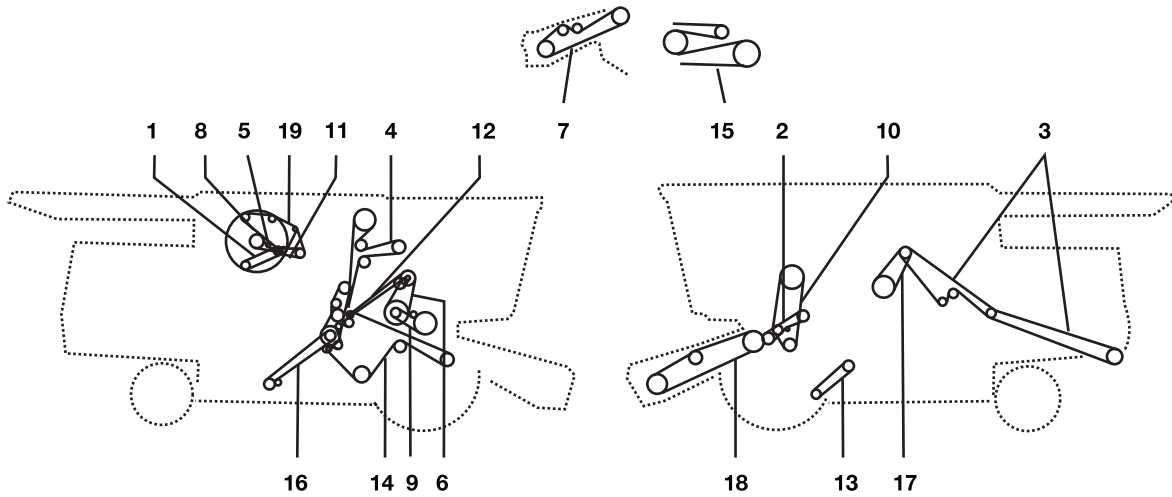

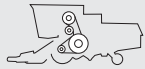
JOHN DEERE 9600

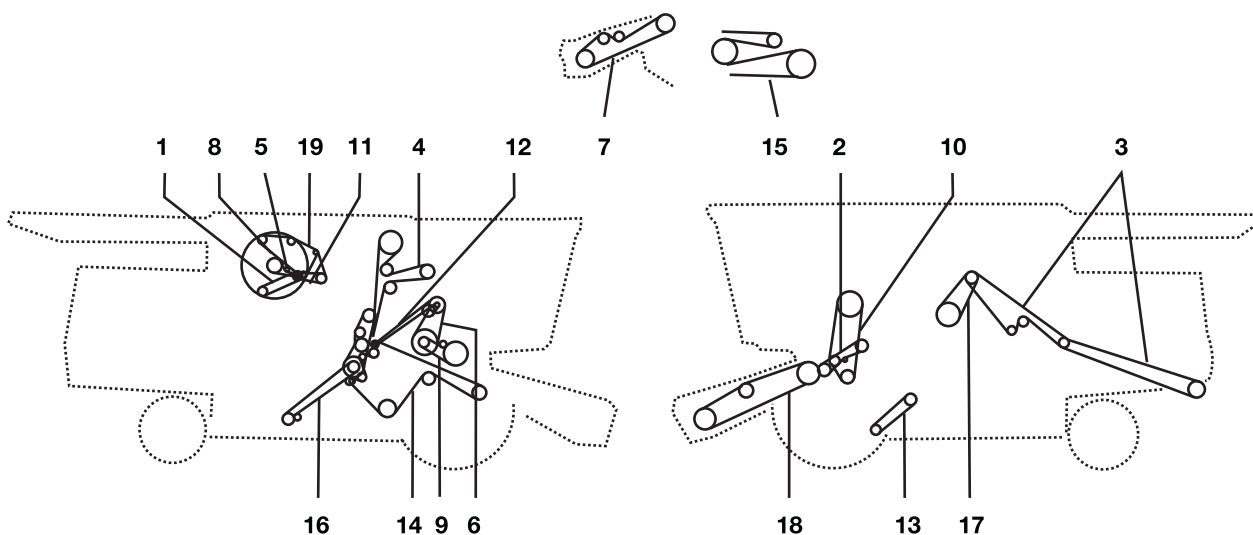

| Belt No. |  | No. of Belts | OEM  Part No. | PIX  Part No. |
|----------|---|--------------|--|--|
| 1 | Cooling Fan | 1 | H132808 | A-H132808 |
| 4 | Air Conditioning Compressor Drive | 1 | H134437 | A-H134437 |
| 5 | Clean Grain Elevator Drive | 1 | H135458 | A-H135458 |
| 5 | Clean Grain Elevator Drive | 1 | H141166 | A-H141166 |
| 6 | Cylinder Drive Intermediate | 1 | H115759 | A-H115759 |
| 6 | For Extended Range | 1 | H137670 | A-H137670 |
| 7 | Cylinder Drive, Slow Speed | 1 | H118618 | A-H118618 |
| 7 | Cylinder Drive Regular Dual Range | 1 | H115881 | A-H115881 |
| 7 | Unloading System | 1 | AH127866 | A-AH127866 |
| 8 | Tailings Auger And Elevator (lower) | 1 | N110085 | A-N110085 |
| 9 | For Alternator | 1 | H134344 | A-H134344 |
| 10 | Countershaft (secondary) | 1 | H128010 | A-H128010 |
| 11 | Straw Walker Shoe - Conveyor Augers | 1 | H131169 | A-H131169 |
| 12 | Unloading System | 1 | AH127866 | A-AH127866 |
| 13 | Short Rear | 1 | P47885 | A-P47885 |
| 13 | Long Rear | 1 | H125381 | A-H125381 |
| 13 | Straw Chopper Drive, front | 1 | H125380 | A-H125380 |
| 14 | Regular | 1 | H140404 | A-H140404 |
| 14 | Slow Speed | 1 | H137264 | A-H137264 |
| 15 | Header And Reel Pump | 1 | H125565 | A-H125565 |
| 15 | Header And Reel Pump | 1 | H140160 | A-H140160 |
| 16 | Feeder Drive Variable Speed | 1 | H125711 | A-H125711 |
| 17 | Beater Optional (75 %) | 1 | AH131960 | A-AH131960 |
| 17 | Beater (100 % Beater Speed) | 2 | AH139436 | A-AH139436 |
| 18 | Feeder House Fixed Speed With Reverser | 1 | H126345 | A-H126345 |
| 19 | Straw Spreader Drive | 1 | H128234 | A-H128234 |

JOHN DEERE 9600 MAXIMIZER

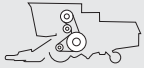

| Belt No. |  | No. of Belts | OEM  Part No. | PIX  Part No. |
|----------|---|--------------|--|--|
| 1 | Cooling Fan | 1 | H132808 | A-H132808 |
| 1 | Cooling Fan | 2 | H153297 | A-H153297 |
| 3 | Rotary Screen Drive | 1 | H146637 | A-H146637 |
| 3 | Rotary Screen Drive | 1 | H146636 | A-H146636 |
| 4 | Air Conditioning Compressor Drive | 1 | H134437 | A-H134437 |
| 4 | Air Conditioning Compressor Drive | 1 | H81742 | A-H81742 |
| 4 | Air Conditioning Compressor Drive | 1 | H80896 | A-H80896 |
| 5 | Clean Grain Elevator Drive | 1 | H135458 | A-H135458 |
| 5 | Clean Grain Elevator Drive | 1 | H141166 | A-H141166 |
| 6 | Cylinder Drive Intermediate | 1 | H162629 | A-H162629 |
| 6 | Cylinder Drive Intermediate | 1 | H210476 | A-H210476 |
| 7 | Cylinder Drive Regulardual-range & single Range | 1 | H115881 | A-H115881 |
| 7 | Cylinder Drive, slow Speed | 1 | H118618 | A-H118618 |
| 8 | Tailings Auger & elevator (lower) | 1 | N110085 | A-N110085 |
| 9 | Header And Reel pump | 1 | H125565 | A-H125565 |
| 9 | Header And Reel pump | 1 | H140160 | A-H140160 |
| 10 | Straw Chopper Drive, Front | 1 | H125380 | A-H125380 |
| 10 | Straw Chopper Drive, Front - Fine Chopper | 1 | H157726 | A-H157726 |
| 10 | Chopper In Windrow Or Forward Position | 1 | P47885 | A-P47885 |
| 10 | Chopper In Windrow Or Forward Position | 1 | H23950 | A-H23950 |
| 10 | Chopper In Rear (operating) Position | 1 | H125381 | A-H125381 |
| 11 | (490-980 Rpm) Opt.speed | 1 | H137264 | A-H137264 |
| 11 | (750-1350 Rpm) Standard Speed | 1 | H140404 | A-H140404 |
| 11 | (750-1600 Rpm) Standard Speed | 1 | H152146 | A-H152146 |
| 11 | (490-980 Rpm) Opt.speed | 1 | H152180 | A-H152180 |
| 12 | Feeder House Fixed Speed With Reverser | 1 | H126345 | A-H126345 |
| 13 | Feeder Drive Variable Speed | 1 | H125711 | A-H125711 |
| 14 | Straw Spreader Drive | 1 | H128234 | A-H128234 |
| 15 | For Alternator | 2 | RE44538 | A-RE44538 |
| 15 | For Alternator | 1 | R73189 | A-R73189 |
| 15 | For Alternator | 1 | H101813 | A-H101813 |
| 16 | Countershaft (secondary) | 1 | H128010 | A-H128010 |
| 17 | Straw Walker Shoe - Conveyor Augers | 1 | H131169 | A-H131169 |

JOHN DEERE 9610

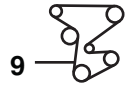

9 Late Model

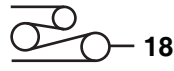





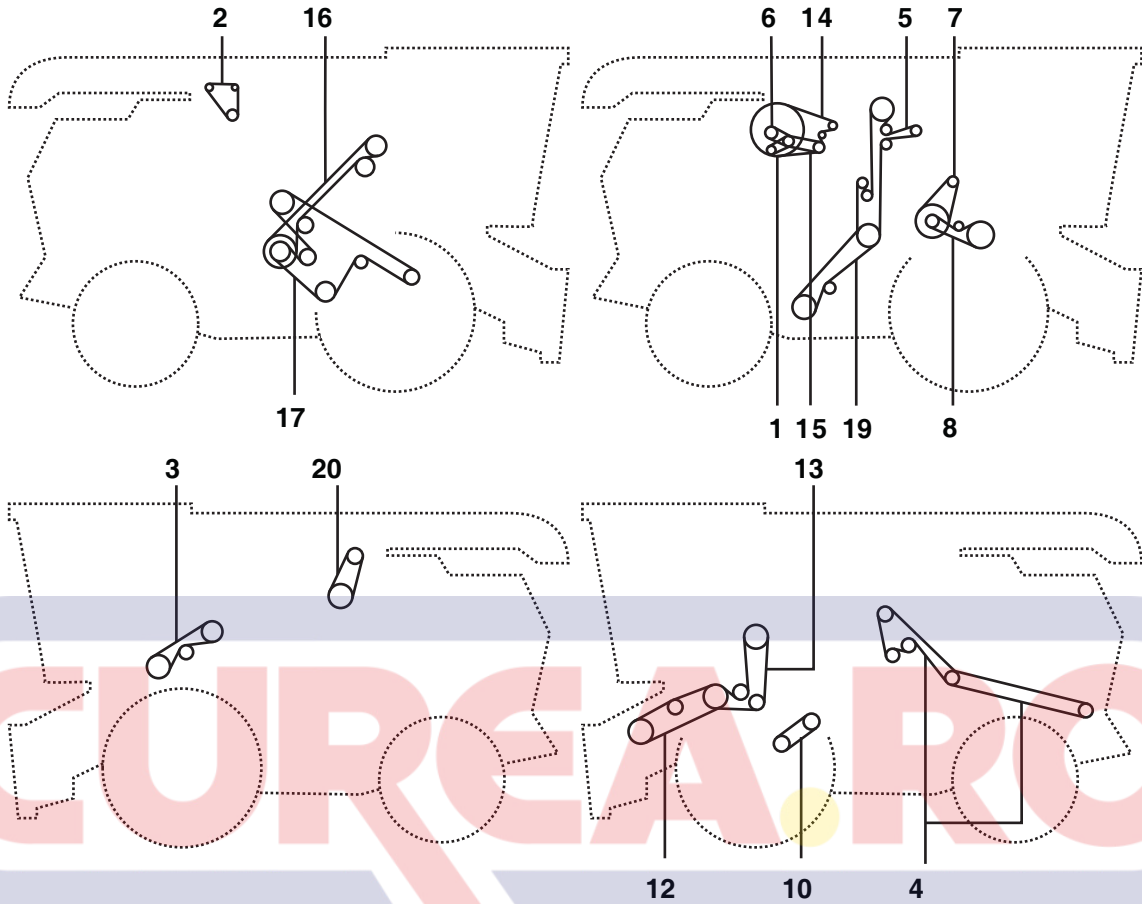

18 Straw Spreader



11 Feederhouse Fixed W/Reverser





| Belt No. |  | No. of Belts | OEM  Part No. | PIX  Part No. |
|----------|---|--------------|--|--|
| 0 | Air Flow Drive | 1 | H164452 | A-H164452 |
| 1 | Air Conditioning Compressor Drive | 2 | H163515 | A-H163515 |
| 2 | Alternator | 1 | H163515 | A-H163515 |
| 3 | Beater Drive (100 %) | 2 | AH139436 | A-AH139436 |
| 3 | Beater Drive (75 %) | 2 | AH163931 | A-AH163931 |
| 4 | Front Chopper | 1 | H125380 | A-H125380 |
| 4 | Chopper In Windrow Or Forward Position (fine Cut) | 1 | H22529 | A-H22529 |
| 4 | Chopper Windrow Or Forward Position | 1 | H23950 | A-H23950 |
| 4 | Rear Chopper (operating) Position | 1 | H125381 | A-H125381 |
| 4 | Front Chopper (fine Cut) | 1 | H157726 | A-H157726 |
| 5 | Clean Grain Elevator | 1 | H141167 | A-H141167 |
| 6 | Cooling Fan | 1 | H153297 | A-H153297 |
| 7 | Cylinder Intermediate Drive | 1 | H210476 | A-H210476 |
| 8 | Cylinder Dr. Regulardual Range & Single Range | 1 | H115881 | A-H115881 |
| 8 | Cylinder Drive,slow Speed | 1 | H118618 | A-H118618 |
| 9 | Alternator | 1 | H163515 | A-H163515 |
| 10 | Fan Drive, Slow Speed | 1 | H152180 | A-H152180 |

| Belt No. |  | No. of Belts | OEM  Part No. | PIX  Part No. |
|-----------------|---|---------------------|---|---|
| 10 | Fan Drive, Regular Speed | 1 | H152146 | A-H152146 |
| 11 | Feederhouse, Fixed Speed With Reverser | 1 | H126345 | A-H126345 |
| 12 | Feederhouse, Variable Speed | 1 | H161648 | A-H161648 |
| 13 | Powershift & Reel Pump, Header | 1 | H151952 | A-H151952 |
| 15 | Rotary Screen Drive | 1 | H146636 | A-H146636 |
| 16 | Secondary Countershaft | 1 | H128010 | A-H128010 |
| 17 | Shoe, Straw Walker & Conveyor Augers | 1 | H131169 | A-H131169 |
| 18 | Straw Spreader | 1 | H128234 | A-H128234 |
| 19 | Tailings Auger Andelevator (lower) | 1 | N110085 | A-N110085 |
| 20 | Unloading System | 2 | AH158880 | A-AH158880 |



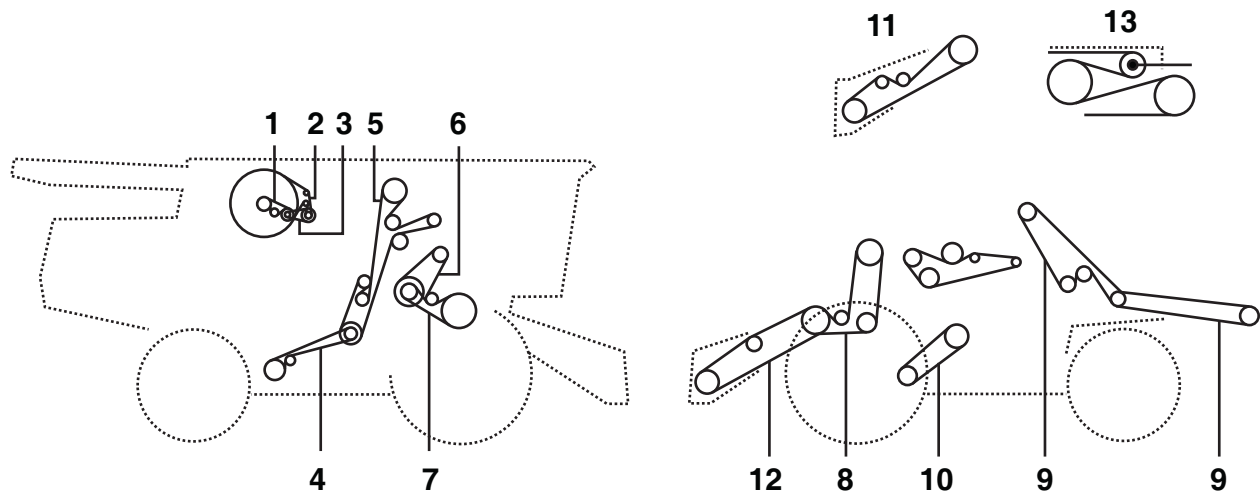

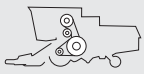

JOHN DEERE 9610 MAXIMIZER

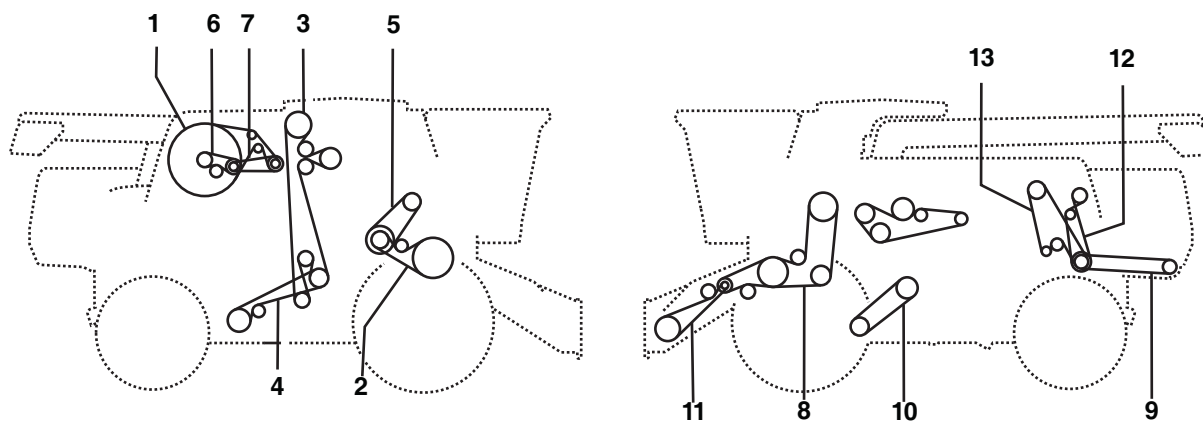

| Belt No. |  | No. of Belts | OEM  Part No. | PIX  Part No. |
|----------|---|--------------|--|--|
| 1 | Cooling Fan | 1 | H153297 | A-H153297 |
| 3 | Rotary Screen Drive | 1 | H146636 | A-H146636 |
| 4 | Lower Tailings Auger & Elevator | 1 | N110085 | A-N110085 |
| 5 | Clean Grain Elevator | 1 | H141167 | A-H141167 |
| 6 | Cylinder Intermediate Drive | 1 | H162629 | A-H162629 |
| 6 | For Extended Range | 1 | H210476 | A-H210476 |
| 7 | Cylinder Drive Regular Dual Range & Single Range | 1 | H115881 | A-H115881 |
| 7 | Cylinder Drive, Slow Speed | 1 | H118618 | A-H118618 |
| 8 | Header And Reel Pump | 1 | H151952 | A-H151952 |
| 9 | Straw Chopper Drive, front | 1 | H125380 | A-H125380 |
| 9 | Chopper In Windrow Orforward Position | 1 | H23950 | A-H23950 |
| 9 | Chopper In Windrow Orforward Position (fine Cut) | 1 | H22529 | A-H22529 |
| 9 | Chopper In Rear (operating) Position | 1 | H125381 | A-H125381 |
| 9 | Chopper Front (fine Cut) | 1 | H157726 | A-H157726 |
| 9 | Chopper Rear (fine Cut) | 1 | H175434 | A-H175434 |
| 10 | Straw Chopper Drive, regular Speed | 1 | H152146 | A-H152146 |
| 10 | Straw Chopper Drive, slow Speed | 1 | H152180 | A-H152180 |
| 11 | Fixed Speed Feeder House With Reverser | 1 | H126345 | A-H126345 |
| 12 | Feeder House Variable Speed | 1 | H161648 | A-H161648 |
| 13 | Straw Spreader | 1 | H128234 | A-H128234 |



JOHN DEERE 9640 (I) WTS - 9660(i) WTS - 9680(I) WTS



| Belt No. |  | No. of Belts | OEM  Part No. | PIX  Part No. |
|----------|---|--------------|--|--|
| 1 | (9640) | 1 | H175632 | A-H175632 |
| 1 | (9660 - 9680) | 1 | H175628 | A-H175628 |
| 2 | - | 1 | H115881 | A-H115881 |
| 3 | (SUB FORH177263) | 1 | HXE51300 | A-HXE51300 |
| 4 | - | 1 | N110085 | A-N110085 |
| 5 | (SUB FORH210476) | 1 | HXE51101 | A-HXE51101 |
| 6 | (9640) | 1 | H177186 | A-H177186 |
| 6 | (9660 - 9680) | 1 | H174455 | A-H174455 |
| 7 | - | 1 | H146636 | A-H146636 |
| 8 | - | 1 | H176765 | A-H176765 |
| 9 | - | 1 | H177442 | A-H177442 |
| 9 | - | 1 | H177178 | A-H177178 |
| 9 | - | 1 | Z59286 | A-Z59286 |
| 10 | - | 1 | H152146 | A-H152146 |
| 10 | - | 1 | H152180 | A-H152180 |
| 11 | - | 1 | H176766 | A-H176766 |
| 11 | - | 1 | H202821 | A-H202821 |
| 12 | (PRIOR TO SER NR 076057) | 1 | Z73879 | A-Z73879 |
| 12 | (FOLLOWING SER NR 076058) | 1 | Z78834 | A-Z78834 |
| 13 | - | 1 | H177177 | A-H177177 |

JOHN DEERE 9650



| Belt No. |  | No. of Belts | OEM  Part No. | PIX  Part No. |
|----------|---|--------------|--|--|
| 1 | Air Conditioning Compressor Drive | 1 | H163515 | A-H163515 |
| 1 | Air Flow Drive | 1 | H171386 | A-H171386 |
| 2 | Alternator (95 Amp) | 1 | H163515 | A-H163515 |
| 2 | Alternator (185 Amp) (prior To Ser Nr 695300) | 1 | H166870 | A-H166870 |
| 2 | Alternator (185 Amp) (following Ser Nr 695301) | 1 | R164820 | A-R164820 |
| 3 | Beater Drive (100%) | 2 | AH139436 | A-AH139436 |
| 3 | Beater Drive (75%) | 2 | AH163931 | A-AH163931 |
| 4 | Clean Grain Elevator | 1 | H141166 | A-H141166 |
| 5 | Cleaning Fan (750 - 1350 Rpm) | 1 | H152146 | A-H152146 |
| 5 | Cleaning Fan (490 - 980 Rpm) | 1 | H152180 | A-H152180 |
| 6 | Cooling Fan(-695300) | 1 | H153297 | A-H153297 |
| 6 | Cooling Fan(695301-) | 1 | H177186 | A-H177186 |
| 7 | Counter shaft Secondary | 1 | H128010 | A-H128010 |
| 8 | Cylinder Intermediate Drive Belt | 1 | H210476 | A-H210476 |
| 8 | Cylinder Drive (240 - 960 Rpm) | 1 | H115881 | A-H115881 |
| 8 | Cylinder Drive (150 - 500 Rpm) | 1 | H118618 | A-H118618 |
| 9 | Engine To Pto Jack shaft (upper) | 1 | H157726 | A-H157726 |
| 10 | Feeder House Variable Speed (-700300) | 1 | H161648 | A-H161648 |
| 10 | Feeder House Variable Speed (700301-) | 1 | H205167 | A-H205167 |
| 11 | Variable Speed Feeder House (hi-capacity) | 1 | H218728 | A-H218728 |
| 12 | Feeder House Fixed Speed W/reverser (-700300) | 1 | H126345 | A-H126345 |
| 12 | Feeder House Fixed Speed W/reverser (700301-) | 1 | H156796 | A-H156796 |
| 13 | Header And Reel Pump (standard) | 1 | H151952 | A-H151952 |
| 13 | Header And Reel Pump (high Cap.) | 1 | H155998 | A-H155998 |
| 14 | Lower Tailings Auger & Elevator | 1 | N110085 | A-N110085 |
| 15 | Rotary Screen (695301-) | 1 | H175632 | A-H175632 |
| 15 | Rotary Screen Drive (-695300) | 1 | H160406 | A-H160406 |
| 15 | Rotary Screen Drive (695301-) | 1 | H146636 | A-H146636 |
| 16 | Shoe, Walker, And Convey Or Augers | 1 | H131169 | A-H131169 |
| 17 | Straw Chopper (fine Cut) | 1 | H175434 | A-H175434 |
| 17 | Straw Chopper (fine Cut Baling) | 1 | H22529 | A-H22529 |
| 17 | Straw Chopper (standard) | 1 | H160654 | A-H160654 |
| 17 | Straw Chopper (standard Baling) | 1 | H23950 | A-H23950 |
| 18 | Straw Spreader | 1 | H128234 | A-H128234 |
| 19 | Unloading System | 2 | Ah158880 | A-AH158880 |

| Belt No. |  | No. of Belts | OEM  Part No. | PIX  Part No. |
|----------|---|--------------|--|--|
| 1 | Alternator (95 Amp) (-695400) | 1 | H163515 | A-H163515 |
| 1 | Alternator (185 Amp) (-695400) | 1 | H166870 | A-H166870 |
| 2 | Alternator (185 Amp) (695401-) | 1 | R164820 | A-R164820 |
| 2 | Counter shaft Secondary | 1 | H128010 | A-H128010 |
| 2 | Conveyor Auger, Sieve, and chaffer | 1 | H131169 | A-H131169 |
| 3 | Cooling Fan (-695400) | 1 | H160405 | A-H160405 |
| 3 | Cooling Fan (695401-) | 1 | H177186 | A-H177186 |
| 3 | Dual Range Cylinder Drive | 1 | H162629 | A-H162629 |
| 5 | Rotary Screen (695401-) | 1 | H175632 | A-H175632 |
| 5 | Rotary Screen Drive (-695400) | 1 | H160406 | A-H160406 |
| 6 | Rotary Screen Drive (695401-) | 1 | H146636 | A-H146636 |
| 6 | Clean Grain Elevator | 1 | H141166 | A-H141166 |
| 7 | Cylinder Intermediate Drive (2290 E.I.) | 1 | H210476 | A-H210476 |
| 8 | Cylinder Intermediate Dr.(2270e.l.) | 1 | H137670 | A-H137670 |
| 8 | Cylinder Drive (2270e.l.) | 1 | H145994 | A-H145994 |
| 8 | Cylinder Drive (2700e.l.) | 1 | H118618 | A-H118618 |
| 9 | Cylinder Drive (2830e.l.) | 1 | H115881 | A-H115881 |
| 10 | Lower Tailings Auger & Elevator | 1 | N110085 | A-N110085 |
| 10 | Header And Reel pump (standard Capacity) | 1 | H151952 | A-H151952 |
| 10 | Header And Reel pump (high Capacity) | 1 | H155998 | A-H155998 |
| 10 | Air Flow Drive | 1 | H171386 | A-H171386 |
| 11 | Chopper Drive | 1 | H162727 | A-H162727 |
| 12 | Cleaning Fan(750 - 1350 Rpm) | 1 | H152146 | A-H152146 |
| 12 | Cleaning Fan(490 - 980 Rpm) | 1 | H152180 | A-H152180 |
| 13 | Feeder House Fixed Speed W/reverser (-700400) | 1 | H126345 | A-H126345 |
| 13 | Feeder House Fixed Speed W/reverser (700401-) | 1 | H156796 | A-H156796 |
| 14 | Feeder House Variable Speed (hi-capacity) | 1 | H218728 | A-H218728 |
| 15 | Feeder House Variable Speed (standard Capacity) (-700400) | 1 | H161648 | A-H161648 |
| 15 | Feeder House Variable Speed (standard Capacity) (700401-) | 1 | H205167 | A-H205167 |
| 15 | Straw Spreader (upper) | 1 | H164870 | A-H164870 |
| 15 | Straw Spreader (lower) | 1 | P49604 | A-P49604 |
| 16 | Tine Separator Drive | 1 | H163106 | A-H163106 |
| 17 | Overshot Beater Drive | 1 | H139963 | A-H139963 |
| 17 | Overshot Beater Drive (740-1170 Rpm) | 1 | H165708 | A-H165708 |
| 17 | Overshot Beater Drive (400 Rpm Slowdown Kit) | 1 | E16774 | A-E16774 |
| 17 | Overshot Beater Drive (700rpm Slowdown Kit) | 1 | N121116 | A-N121116 |
| 18 | Stripper Beater Drive | 1 | H165708 | A-H165708 |
| 19 | Unloading System | 2 | AH158880 | A-AH158880 |

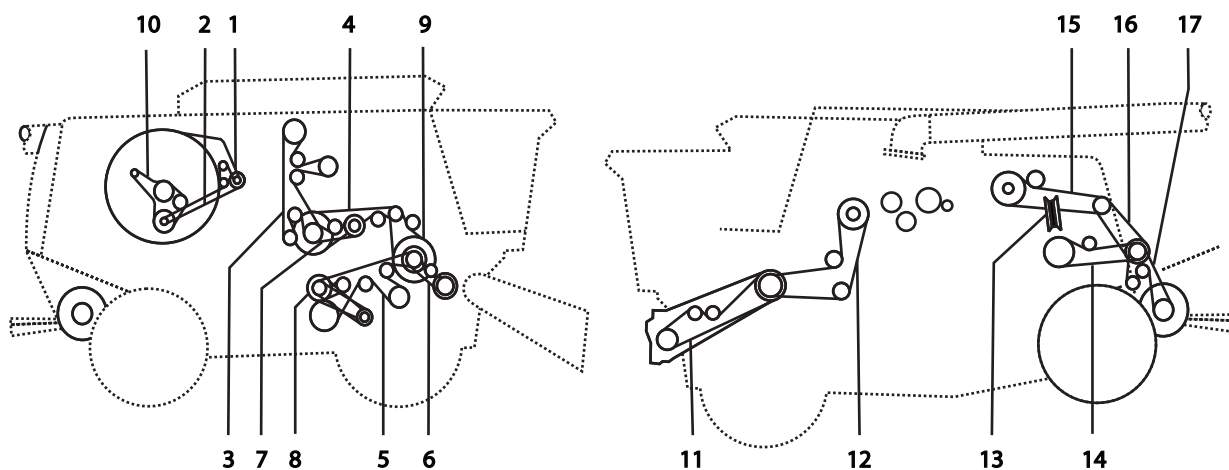
JOHN DEERE 9650 STS - 9750 STS







| Belt No. |  | No. of Belts | OEM  Part No. | PIX  Part No. |
|----------|---|--------------|--|--|
| 1 | Rotary Screen Drive | 1 | H206807 | A-H206807 |
| 2 | Rotary Screen Drive | 1 | H157104 | A-H157104 |
| 3 | Clean Grain Elevator | 1 | H218645 | A-H218645 |
| 4 | Jackshaft - Right Hand (rear) | 1 | H154723 | A-H154723 |
| 5 | Shoe Fan & Conveyor Augers | 1 | H166759 | A-H166759 |
| 5 | Shoe Fan & Conveyor Augers (heavy Duty) | 1 | H175587 | A-H175587 |
| 6 | Feeder Accelerator (slow Speed Or Rice) | 1 | H201821 | A-H201821 |
| 6 | Feeder Accelerator (slow Speed Or Rice) | 1 | H221732 | A-H221732 |
| 6 | Feeder Accelerator (standard) | 1 | H221731 | A-H221731 |
| 7 | Tailings Auger And Elevator | 1 | H154731 | A-H154731 |
| 8 | Cleaning Fan Drive | 1 | H165072 | A-H165072 |
| 9 | Jackshaft Right Hand (front) | 2 | AH150678 | A-AH150678 |
| 11 | Feeder House Variable Drive (standard) (9650 Sts)(following Ser Nr 700501) | 1 | H205169 | A-H205169 |
| 11 | Feeder House Variable Drive (standard) (9650 Sts)(prior To Ser Nr 700500) | 1 | H157732 | A-H157732 |
| 11 | Feeder House Variable Drive (standard) (9750 Sts)(following Ser Nr 700601) | 1 | H205169 | A-H205169 |
| 11 | Feeder House Variable Drive (standard) (9750 Sts)(prior To Ser Nr 700600) | 1 | H157732 | A-H157732 |
| 11 | Feeder House Variable Drive (sub Forh166457) (hi-capacity) | 1 | H218726 | A-H218726 |
| 12 | Header And Reel Pump (hi-capacity) | 1 | H156541 | A-H156541 |
| 12 | Header And Reel Pump (standard Capacity & Fixed Speed) | 1 | H156796 | A-H156796 |
| 13 | Sts Variable Drive | 1 | H221498 | A-H221498 |
| 14 | Discharge Beater Drive | 1 | H168301 | A-H168301 |
| 15 | Unloading Auger Drive | 2 | AH160080 | A-AH160080 |
| 16 | Countershaft - Discharge Beater & chopper | 1 | HXE15671 | A-HXE15671 |
| 17 | Straw Chopper Drive (9650 Sts) (prior To Ser Nr 700500) | 1 | H157523 | A-H157523 |
| 17 | Straw Chopper Drive (9650 Sts) (prior To Ser Nr 700500) | 1 | H201571 | A-H201571 |
| 17 | Straw Chopper Drive (9750 Sts) (prior To Ser Nr 700600) | 1 | H201571 | A-H201571 |

| Belt No. |  | No. of Belts | OEM  Part No. | PIX  Part No. |
|----------|---|--------------|--|--|
| 17 | Straw Chopper Drive (9750 Sts) (prior To Sr Nr 700600) | 1 | H157523 | A-H157523 |
| 17 | Straw Chopper Drive (sub For H204747) (9650 Sts) (following Ser Nr 700601) | 1 | H235564 | A-H235564 |
| 17 | Straw Chopper Drive (sub For H204747) (9750 Sts) (following Ser Nr 700601) | 1 | H235564 | A-H235564 |
| 18 | Fixed Speed Feeder House (9650 Sts) (following Ser Nr 700501) | 1 | H125565 | A-H125565 |
| 18 | Fixed Speed Feeder House (9650 Sts) (prior To Ser Nr 700500) | 1 | H111519 | A-H111519 |
| 18 | Fixed Speed Feeder House (9750 Sts) (following Ser Nr 700601) | 1 | H125565 | A-H125565 |
| 18 | Fixed Speed Feeder House (9750 Sts) (prior To Ser Nr 700600) | 1 | H111519 | A-H111519 |

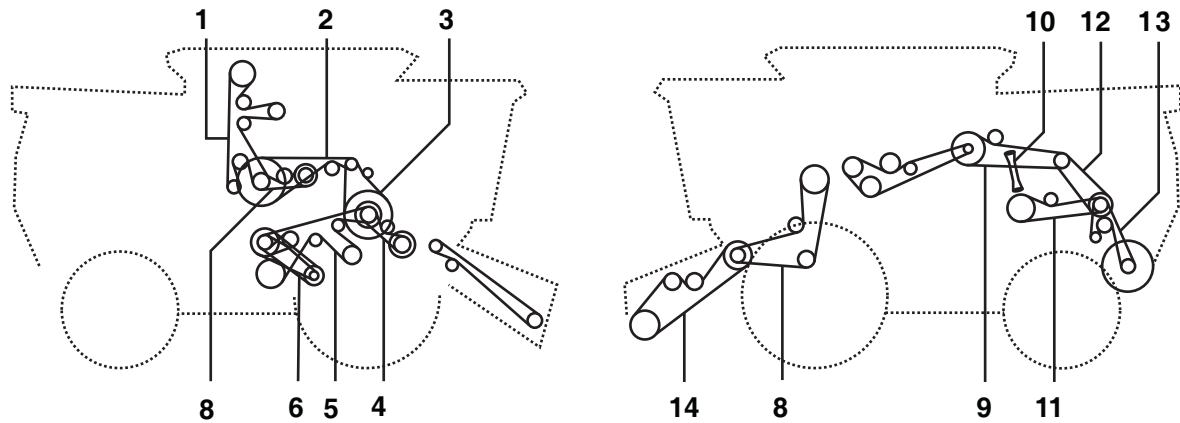



JOHN DEERE 9650 STS -9750 STS - SA EDITION



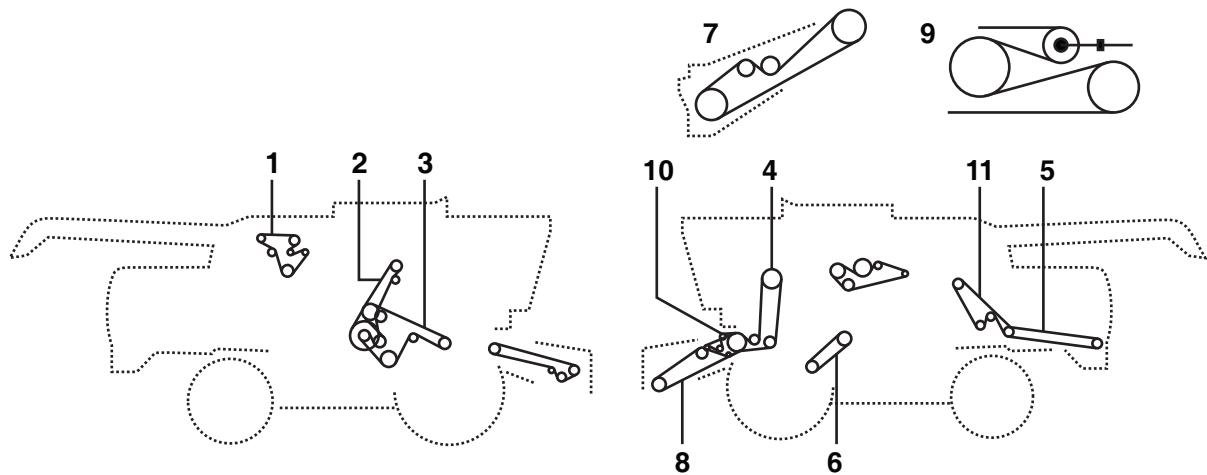

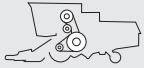

| Belt No. |  | No. of Belts | OEM  Part No. | PIX  Part No. |
|----------|---|--------------|--|--|
| 1 | Clean Grain Elevator | 1 | H206738 | A-H206738 |
| 2 | Jackshaft - Right Hand (rear) | 1 | H154723 | A-H154723 |
| 3 | Jackshaft Right Hand (front) | 2 | AH150678 | A-AH150678 |
| 4 | Feeder Accelerator (standard) | 1 | H204133 | A-H204133 |
| 4 | Feeder Accelerator (slow Speed Or Rice) | 1 | H209606 | A-H209606 |
| 4 | Feeder Accelerator (slow Speed Or Rice) | 1 | H221731 | A-H221731 |
| 5 | - | - | H175587 | A-H175587 |
| 6 | Shoe Fanand Conveyor Augers | 1 | H165072 | A-H165072 |
| 6 | Shoe Fanand Conveyor Augers | 1 | H206048 | A-H206048 |
| 7 | Tailings Auger Andelevator (edible Bean) | 1 | H154731 | A-H154731 |
| 7 | Tailings Auger Andelevator | 1 | H175587 | A-H175587 |
| 8 | Header & Reelpump (hi-capacity) | 1 | H156541 | A-H156541 |
| 9 | Unloading Auger Drive | 2 | AH160080 | A-AH160080 |
| 10 | Sts Variable Drive (prior To Ser Nr 000416) | 1 | H165545 | A-H165545 |
| 10 | Sts Variable Drive (follow Ser Nr 000417) | 1 | H221498 | A-H221498 |
| 11 | Discharge Beater Drive | 1 | H219182 | A-H219182 |
| 12 | - | 1 | H157514 | A-H157514 |
| 12 | Countershaft - Discharge Beater & Chopper | 1 | H204747 | A-H204747 |
| 13 | Straw Chopper Drive | 1 | H173024 | A-H173024 |

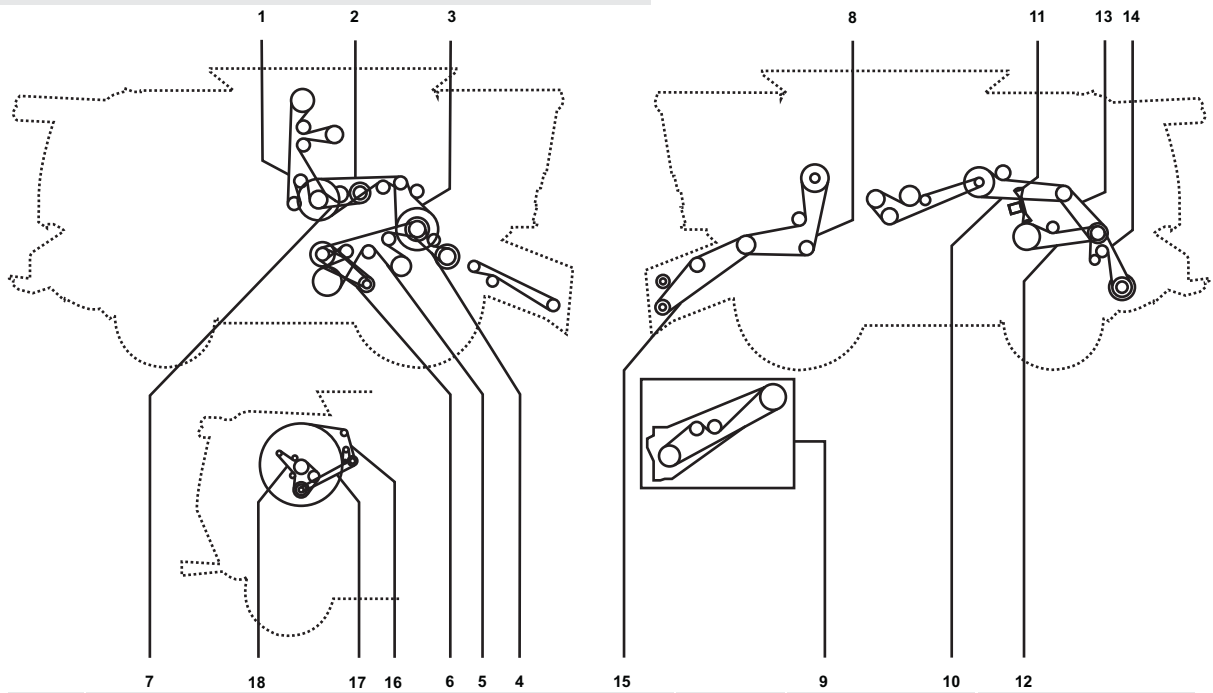

| Belt No. |  | No. of Belts | OEM  Part No. | PIX  Part No. |
|----------|---|--------------|--|--|
| 1 | Alternator (95 Amp) | 1 | H163515 | A-H163515 |
| 1 | Alternator (185 Amp) | 1 | R164820 | A-R164820 |
| 2 | Counter shaft (secondary) | 1 | H128010 | A-H128010 |
| 3 | Shoe, Walker & conveyor Augers | 1 | H131169 | A-H131169 |
| 4 | Header And Reel Pump (standard Capacity) | 1 | H151952 | A-H151952 |
| 4 | Header And Reel Pump (high Capacity) | 1 | H155998 | A-H155998 |
| 5 | Straw Chopper (fine Cut) | 1 | H175434 | A-H175434 |
| 5 | Straw Chopper (fine Cut Baling) | 1 | H22529 | A-H22529 |
| 5 | Straw Chopper (standard) | 1 | H160654 | A-H160654 |
| 5 | Straw Chopper (standard Baling) | 1 | H23950 | A-H23950 |
| 6 | Cleaning Fan (750 - 1350 Rpm) | 1 | H152146 | A-H152146 |
| 6 | Cleaning Fan (490 - 980 Rpm) | 1 | H152180 | A-H152180 |
| 7 | Feeder house Fixed Speed W/ Reverser | 1 | H203473 | A-H203473 |
| 8 | Variable Speed (standard capacity) | 1 | H203393 | A-H203393 |
| 8 | Variable Speed (high Capacity) | 1 | H218728 | A-H218728 |
| 9 | Straw Spreader | 1 | H128234 | A-H128234 |
| 10 | Air Flow Drive | 1 | H171386 | A-H171386 |
| 11 | Straw Chopper (front) | 1 | H157726 | A-H157726 |



JOHN DEERE 9660 STS



| Belt No. |  | No. of Belts | OEM  Part No. | PIX  Part No. |
|----------|---|--------------|--|--|
| 1 | Clean Grain Elevator | 1 | H218645 | A-H218645 |
| 2 | R.h. Jackshaft, Rear | 1 | H154723 | A-H154723 |
| 2 | R.h. Jackshaft, Front | 2 | AH150678 | A-AH150678 |
| 3 | Feed Accelerator, Standardspeed -715400 | 1 | H221731 | A-H221731 |
| 3 | Feed Accelerator, Standardspeed 715401- | 1 | H236472 | A-H236472 |
| 3 | Feed Accelerator, Slow Speed | 1 | H221732 | A-H221732 |
| 3 | Feed Accelerator, High Speed | 1 | H221733 | A-H221733 |
| 4 | Shoe Fan Andconveyor Augers | 1 | H175587 | A-H175587 |
| 5 | Cleaning Fan | 1 | H206048 | A-H206048 |
| 5 | Cleaning Fan, Slow Speed | 1 | H211601 | A-H211601 |
| 6 | Tailings Auger Andelevator | 1 | H154731 | A-H154731 |
| 7 | Header And Reelpump, Standardcapacity | 1 | H156796 | A-H156796 |
| 7 | Header And Reelpump, High Capacity | 1 | H156541 | A-H156541 |
| 8 | Unloading Auger System | 2 | AH160080 | A-AH160080 |
| 9 | Variable Rotor Drive | 1 | H221498 | A-H221498 |
| 10 | Discharge Beater | 1 | H168301 | A-H168301 |
| 11 | Countershaft, Discharge Beater And Chopper | 1 | HXE15671 | A-HXE15671 |
| 12 | Straw Chopper | 1 | H235564 | A-H235564 |
| 13 | Variable Drive Feeder House, Standard Capacity | 1 | H201334 | A-H201334 |
| 13 | Variable Drive Feeder House, High Capacity | 1 | H218726 | A-H218726 |
| 13 | Variable Drive Feeder House, High Capacity (High Torque) | 1 | H220911 | A-H220911 |
| 14 | Fixed Speed Feeder House | 1 | H203474 | A-H203474 |
| 15 | Rotary Screen Drive, Screen Side-715400 | 1 | H175628 | A-H175628 |
| 15 | Rotary Screen Drive, Screen Side715401- | 1 | H214241 | A-H214241 |
| 15 | Rotary Screen Drive, Engine Side -715400 | 1 | H206807 | A-H206807 |
| 15 | Rotary Screen Drive, Engine Side 715401- | 1 | H213353 | A-H213353 |
| 16 | Alternator, 95 Amp | 1 | R135606 | A-R135606 |
| 16 | Alternator, 185 Amp | 1 | R135609 | A-R135609 |
| 16 | Alternator, 200 Amp | 1 | AT262958 | A-AT262958 |

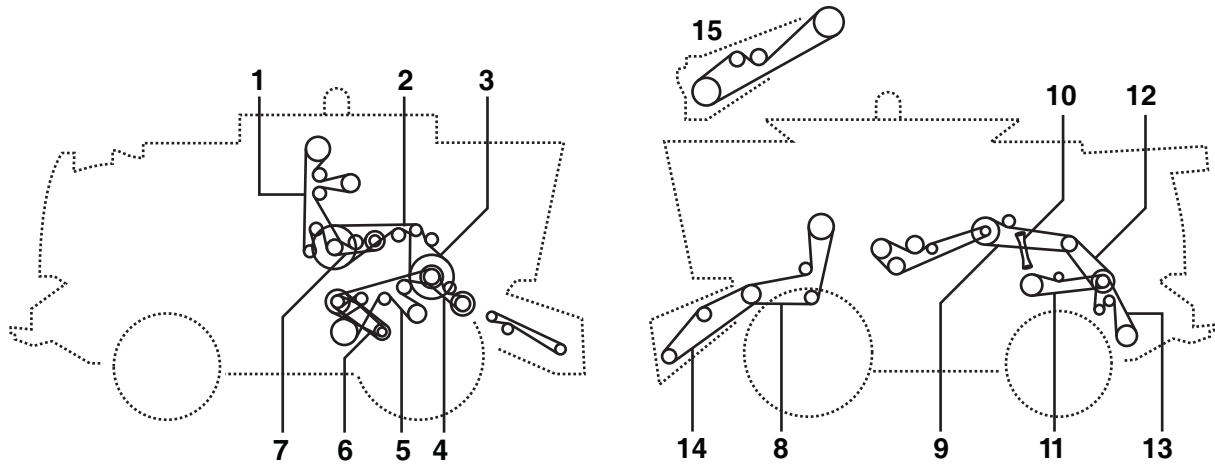

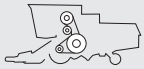
JOHN DEERE 9670 STS (NA EDITION)



| Belt No. |  | No. of Belts | OEM  Part No. | PIX  Part No. |
|----------|---|--------------|--|--|
| 1 | Clean Grain Elevator | 1 | H218645 | A-H218645 |
| 2 | Right Hand Jackshaft (rear) | 1 | H154723 | A-H154723 |
| 3 | Right Hand Jackshaft (front) | 2 | AH150678 | A-AH150678 |
| 4 | Feed Accelerator, Standard Speed | 1 | H236472 | A-H236472 |
| 4 | Feed Accelerator, Slow Speed | 1 | H221732 | A-H221732 |
| 4 | Feed Accelerator, High Speed | 1 | H221733 | A-H221733 |
| 4 | Thank You Gates | 1 | H230230 | A-H230230 |
| 5 | Shoe Fan And Conveyor Augers | 1 | H175587 | A-H175587 |
| 6 | Cleaning Fan | 1 | H230909 | A-H230909 |
| 6 | Cleaning Fan, Slow Speed | 1 | H215389 | A-H215389 |
| 7 | Tailings Auger And Elevator | 1 | H154731 | A-H154731 |
| 8 | Header And Reel Pump (fixed Speed) | 1 | H156796 | A-H156796 |
| 8 | Header And Reel Pump (variable Speed) | 1 | H156541 | A-H156541 |
| 8 | Header And Reel Pump (multi Speed Feeder house Drive) | 1 | H229018 | A-H229018 |
| 9 | Unloading Auger System | 2 | AH160080 | A-AH160080 |
| 10 | Variable Rotor Drive | 1 | H221498 | A-H221498 |
| 11 | Discharge Beater | 1 | H168301 | A-H168301 |
| 12 | Countershaft, Discharge Beater And Chopper | 1 | HXE15671 | A-HXE15671 |
| 12 | Regular | 1 | HXE10556 | A-HXE10556 |
| 13 | Straw Chopper | 1 | H232997 | A-H232997 |
| 13 | Straw Chopper (cis) | 1 | H235564 | A-H235564 |
| 14 | Variable Speed Feeder House Drive | 1 | H218726 | A-H218726 |
| 14 | Variable Speed Feeder House Drive (high Speed) | 1 | H220911 | A-H220911 |
| 15 | Fixed Speed Feederhouse | 1 | H203474 | A-H203474 |
| 15 | Fixed Speed Feeder house (multi Speed Feeder House Drive) | 1 | H229019 | A-H229019 |

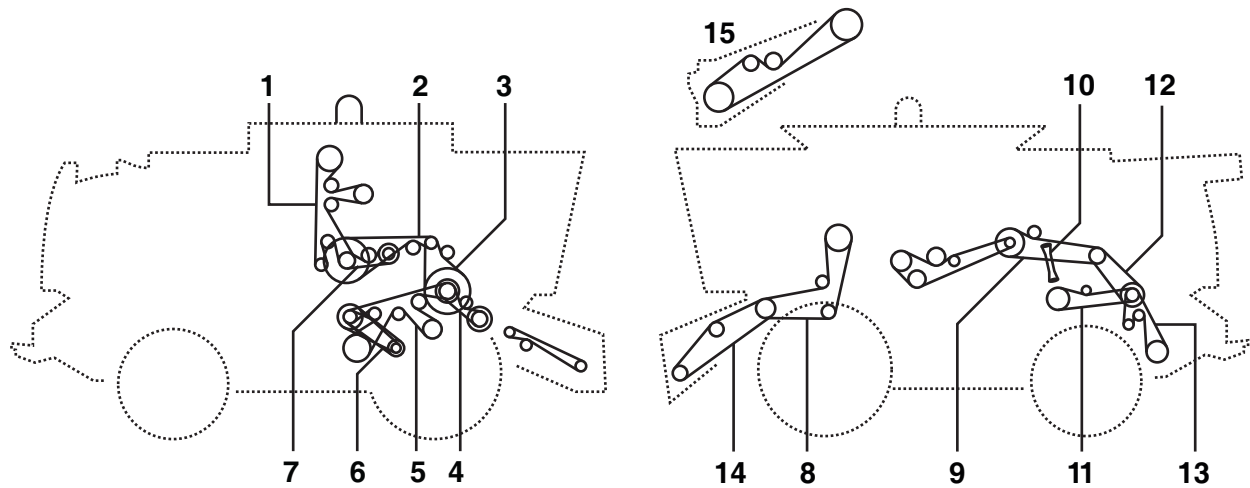

JOHN DEERE 9670 STS - 9770 STS (SA EDITION)



| Belt No. |  | No. of Belts | OEM  Part No. | PIX  Part No. |
|----------|---|--------------|--|--|
| 1 | Clean Grain Elevator | 1 | H218645 | A-H218645 |
| 2 | R.H. Jackshaft, Rear | 1 | H154723 | A-H154723 |
| 3 | R.H. Jackshaft, Front | 2 | AH150678 | A-AH150678 |
| 4 | Feed Accelerator, Standardspeed | 1 | H236472 | A-H236472 |
| 4 | Feed Accelerator, Slow Speed | 1 | H221732 | A-H221732 |
| 4 | Feed Accelerator, High Speed | 1 | H221733 | A-H221733 |
| 5 | Shoe Fan Andconveyor Augers | 1 | H175587 | A-H175587 |
| 6 | Cleaning Fan | 1 | H206048 | A-H206048 |
| 6 | Cleaning Fan, Slow Speed | 1 | H215389 | A-H215389 |
| 7 | Tailings Auger Andelevator | 1 | H154731 | A-H154731 |
| 8 | Header And Reelpump (fixed Speed) | 1 | H156796 | A-H156796 |
| 8 | Header And Reelpump (variable Speed) | 1 | H156541 | A-H156541 |
| 8 | Header And Reel(multi Speed Feeder House Drive) | 1 | H229018 | A-H229018 |
| 9 | Unloading Auger System | 2 | AH160080 | A-AH160080 |
| 10 | Variable Rotor Drive | 1 | H221498 | A-H221498 |
| 11 | Discharge Beater | 1 | H168301 | A-H168301 |
| 12 | Countershaft, Discharge Beater And Chopper | 1 | H223385 | A-H223385 |
| 13 | Straw Chopper | 1 | H232997 | A-H232997 |
| 13 | Straw Chopper (cis) | 1 | H204747 | A-H204747 |
| 14 | Variable Speed Feeder House Drive | 1 | H218726 | A-H218726 |
| 14 | Variable Speed Feeder House Drive | 1 | H220911 | A-H220911 |
| 15 | Variable Speed Feeder House Drive (high Speed) | 1 | H203474 | A-H203474 |
| 15 | Rotary Screen Drive, Screen Side | 1 | H229019 | A-H229019 |

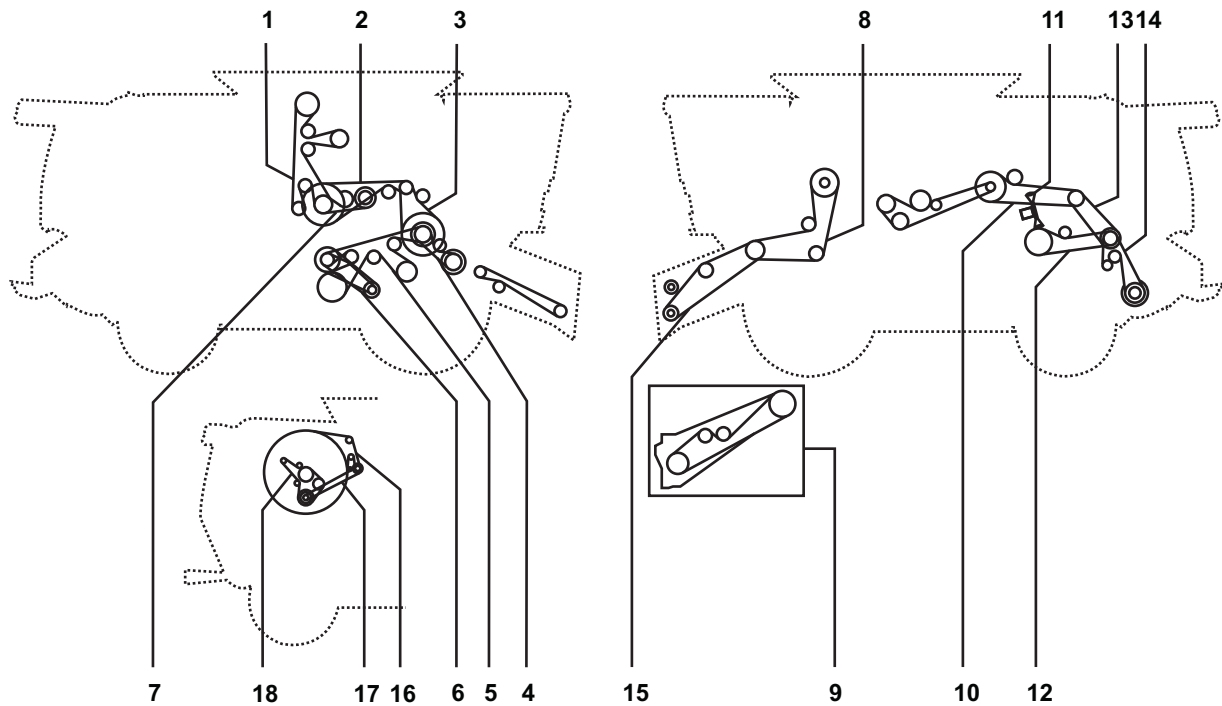

JOHN DEERE 9670 STS - 9770 STS (SA EDITION)



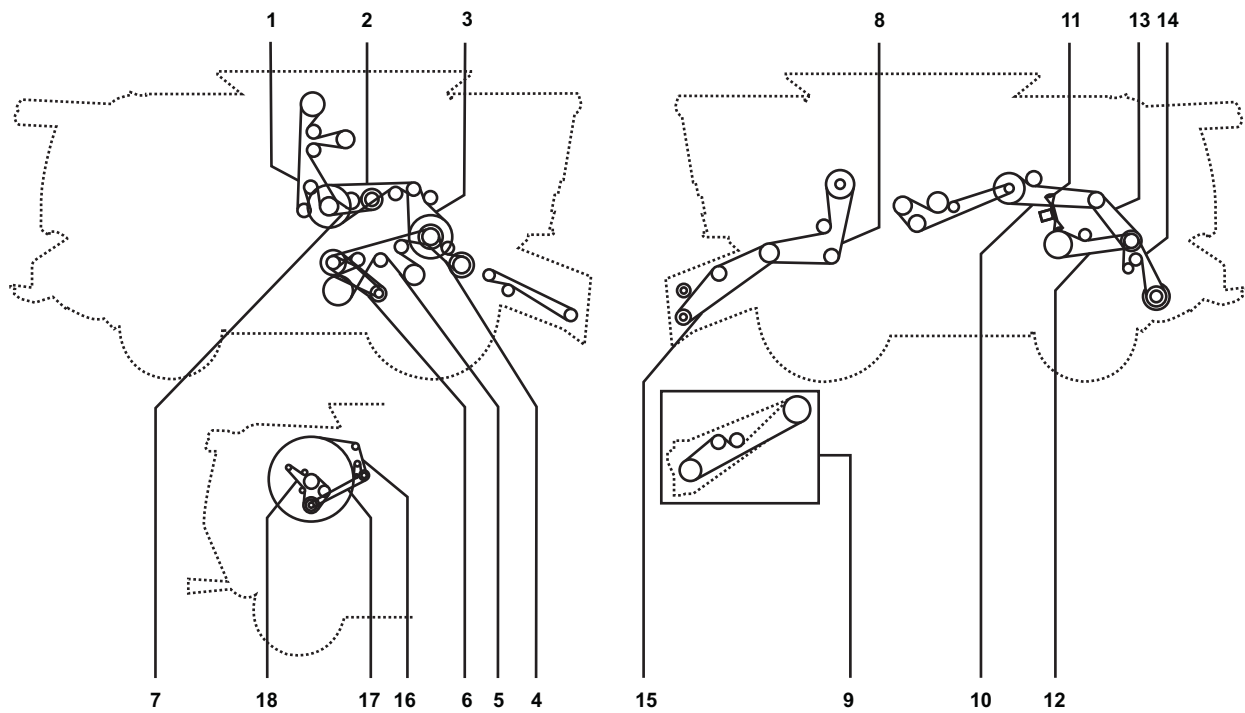

| Belt No. | | No. of Belts | OEM  Part No. | PIX  Part No. |
|----------|---|--------------|--|--|
| 1 | Clean Grain Elevator | 1 | H218645 | A-H218645 |
| 2 | R.H. Jackshaft, Rear | 1 | H154723 | A-H154723 |
| 3 | R.H. Jackshaft, Front | 2 | AH150678 | A-AH150678 |
| 4 | Feed Accelerator, Standardspeed | 1 | H236472 | A-H236472 |
| 4 | Feed Accelerator, Slow Speed | 1 | H221732 | A-H221732 |
| 4 | Feed Accelerator, High Speed | 1 | H221733 | A-H221733 |
| 5 | Shoe Fan Andconveyor Augers | 1 | H175587 | A-H175587 |
| 6 | Cleaning Fan | 1 | H206048 | A-H206048 |
| 6 | Cleaning Fan, Slow Speed | 1 | H215389 | A-H215389 |
| 7 | Tailings Auger Andelevator | 1 | H154731 | A-H154731 |
| 8 | Header And Reelpump (fixed Speed) | 1 | H156796 | A-H156796 |
| 8 | Header And Reelpump (variable Speed) | 1 | H156541 | A-H156541 |
| 8 | Header And Reel(multi Speed Feeder House Drive) | 1 | H229018 | A-H229018 |
| 9 | Unloading Auger System | 2 | AH160080 | A-AH160080 |
| 10 | Variable Rotor Drive | 1 | H221498 | A-H221498 |
| 11 | Discharge Beater | 1 | H168301 | A-H168301 |
| 12 | Countershaft, Discharge Beater And Chopper | 1 | H223385 | A-H223385 |
| 13 | Straw Chopper | 1 | H232997 | A-H232997 |
| 13 | Straw Chopper (cis) | 1 | H204747 | A-H204747 |
| 14 | Variable Speed Feeder House Drive | 1 | H218726 | A-H218726 |
| 14 | Variable Speed Feeder House Drive | 1 | H220911 | A-H220911 |
| 15 | Variable Speed Feeder House Drive (high Speed) | 1 | H203474 | A-H203474 |
| 15 | Rotary Screen Drive, Screen Side | 1 | H229019 | A-H229019 |

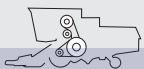
JOHN DEERE 9760 STS





| Belt No. |  | No. of Belts | OEM  Part No. | PIX  Part No. |
|----------|---|--------------|--|--|
| 1 | Clean Grain Elevator Drive | 1 | H218645 | A-H218645 |
| 2 | Jackshaft - Right Hand (rear) | 1 | H154723 | A-H154723 |
| 3 | Jackshaft - (front) Right Hand | 2 | AH150678 | A-AH150678 |
| 4 | Feeder Accelerator - Standard Speed (serial Nr. 715301 - ...) | 1 | H211581 | A-H211581 |
| 4 | Feeder Accelerator - Standard Speed (serial Nr. ... - 715301) | 1 | H221731 | A-H221731 |
| 4 | Feeder Accelerator - Low Speed | 1 | H221732 | A-H221732 |
| 4 | Feeder Accelerator - High Speed | 1 | H221733 | A-h221733 |
| 5 | Shoe Fan And Conveyor Augers | 1 | H175587 | A-H175587 |
| 6 | Cleaning Fan Drive | 1 | H206048 | A-H206048 |
| 6 | Cleaning Fan - Slow Speed | 1 | H211601 | A-H211601 |
| 7 | Tailings Auger And Elevator | 1 | H154731 | A-H154731 |
| 8 | Header And Reel Pump (standard Capacity) | 1 | H156796 | A-H156796 |
| 8 | Header And Reel Pump (high Capacity) | 1 | H156541 | A-H156541 |
| 9 | Feeder House Fixed Speed | 1 | H203474 | A-H203474 |
| 10 | Unloading Auger Drive | 2 | AH160080 | A-AH160080 |
| 11 | Rotor Variator Drive | 1 | H169449 | A-H169449 |
| 12 | Discharge Beater Drive | 1 | H168301 | A-H168301 |
| 13 | Countershaft - Discharge Beater Andchopper | 1 | H157514 | A-H157514 |
| 14 | Straw Chopper Drive | 1 | H204747 | A-H204747 |
| 15 | Feeder House Variable Drive (high Capacity) | 1 | H218726 | A-H218726 |
| 16 | Rotary Screen Drive - Screen Side | 1 | H175632 | A-H175632 |
| 17 | Rotary Screen Drive - Engine Side | 1 | H206807 | A-H206807 |
| 18 | Alternator Drive (95 Amp) | 1 | R135606 | A-R135606 |
| 18 | Alternator Drive (185 Amp) | 1 | R135609 | A-R135609 |

| Belt No. |  | No. of Belts | OEM  Part No. | PIX  Part No. |
|----------|---|--------------|--|--|
| 1 | Clean Grain Elevator | 1 | H218645 | A-H218645 |
| 2 | Right Hand Jack shaft (rear) | 1 | H154723 | A-H154723 |
| 3 | Right Hand Jack shaft (front) | 2 | AH150678 | A-AH150678 |
| 4 | Feed Accelerator, Standard speed | 1 | H236472 | A-H236472 |
| 4 | Feed Accelerator, Slow Speed | 1 | H221732 | A-H221732 |
| 4 | Feed Accelerator, High Speed | 1 | H221733 | A-H221733 |
| 4 | - | 1 | H230230 | A-H230230 |
| 5 | Shoe Fan And conveyor Augers | 1 | H175587 | A-H175587 |
| 6 | Cleaning Fan | 1 | H230909 | A-H230909 |
| 6 | Cleaning Fan, Slow Speed | 1 | H215389 | A-H215389 |
| 7 | Tailings Auger And elevator | 1 | H154731 | A-H154731 |
| 8 | Header And Reel pump (fixed Speed) | 1 | H156796 | A-H156796 |
| 8 | Header And Reel pump (variable Speed) | 1 | H156541 | A-H156541 |
| 8 | Header And Reel pump (multi Speed Feeder house Drive) | 1 | H229018 | A-H229018 |
| 9 | Unloading Auger System | 2 | AH160080 | A-AH160080 |
| 10 | Variable Rotor Drive | 1 | H208431 | A-H208431 |
| 11 | Discharge Beater | 1 | H168301 | A-H168301 |
| 12 | Counter shaft, Discharge Beater And Chopper | 1 | HXE15671 | A-HXE15671 |
| 12 | Regular | 1 | HXE10556 | A-HXE10556 |
| 12 | Heavy Duty | 1 | HXE10501 | A-HXE10501 |
| 13 | Straw Chopper | 1 | H223212 | A-H223212 |
| 14 | Variable Speed Feeder House Drive | 1 | H218726 | A-H218726 |
| 14 | Variable Speed Feeder House Drive (high Speed) | 1 | H220911 | A-H220911 |
| 15 | Fixed Speed Feeder house | 1 | H203474 | A-H203474 |
| 15 | Fixed Speed Feeder house (multi Speed Feeder House Drive) | 1 | H229019 | A-H229019 |

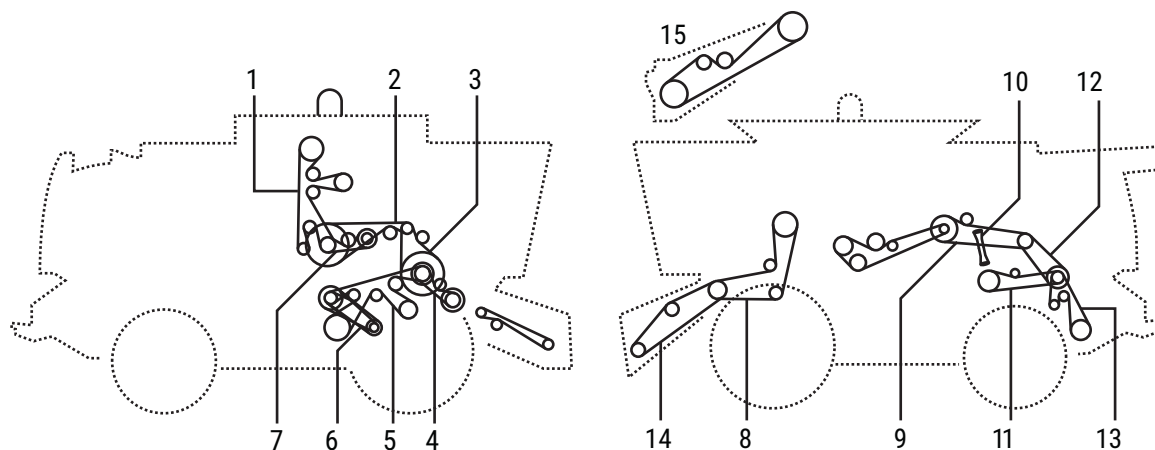

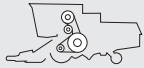
JOHN DEERE 9860 STS (NA EDITION)



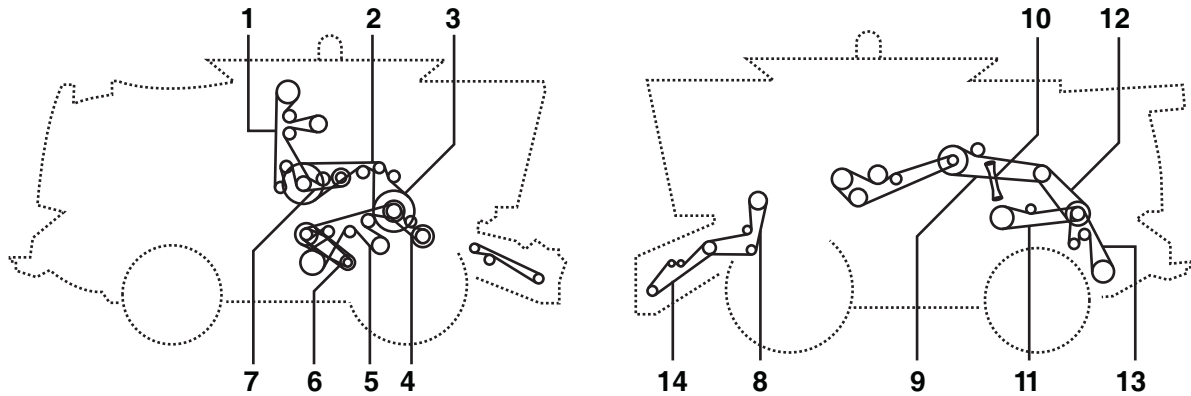

| Belt No. |  | No. of Belts | OEM  Part No. | PIX  Part No. |
|----------|---|--------------|--|--|
| 1 | Clean Grain Elevator | 1 | H218645 | A-H218645 |
| 2 | Right Hand Jackshaft (rear) | 1 | H154723 | A-H154723 |
| 3 | Right Hand Jackshaft (front) | 2 | AH150678 | A-AH150678 |
| 4 | Feed Accelerator, Standard Speed | 1 | H221731 | A-H221731 |
| 4 | Feed Accelerator, Standard Speed | 1 | H236472 | A-H236472 |
| 4 | Feed Accelerator, Slow Speed | 1 | H201821 | A-H201821 |
| 4 | Feed Accelerator, Slow Speed | 1 | H221732 | A-H221732 |
| 4 | Feed Accelerator, High Speed | 1 | H205209 | A-H205209 |
| 4 | Feed Accelerator, High Speed | 1 | H221733 | A-H221733 |
| 5 | Shoe Fan And Conveyor Augers | 1 | H175587 | A-H175587 |
| 6 | Cleaning Fan | 1 | H206048 | A-H206048 |
| 6 | Cleaning Fan (slow Speed) | 1 | H211601 | A-H211601 |
| 7 | Tailings Auger And Elevator | 1 | H154731 | A-H154731 |
| 8 | Header And Reel Pump, Standard Capacity | 1 | H156796 | A-H156796 |
| 8 | Header And Reel Pump, High Capacity | 1 | H156541 | A-H156541 |
| 9 | Unloading Auger System | 2 | AH160080 | A-AH160080 |
| 10 | Variable Rotor Drive | 1 | H207851 | A-H207851 |
| 10 | Variable Rotor Drive | 1 | H208431 | A-H208431 |
| 11 | Discharge Beater | 1 | H168301 | A-H168301 |
| 12 | Countershaft, Discharge Beater & Chopper (Heavy Duty) | 1 | H201596 | A-H201596 |
| 12 | Countershaft, Discharge Beater & Chopper (standard) | 1 | HXE15671 | A-HXE15671 |
| 13 | Straw Chopper | 1 | H220747 | A-H220747 |
| 13 | Straw Chopper (premium Grain) | 1 | H217352 | A-H217352 |
| 14 | Variable Drive Feeder House | 1 | H218726 | A-H218726 |
| 14 | Variable Drive Feeder House (extra Heavy Duty) | 1 | H220911 | A-H220911 |
| 15 | Fixed Speed Feeder House | 1 | H203474 | A-H203474 |
| 15 | Extra Heavy Duty | 1 | H174885 | A-H174885 |

JOHN DEERE 9870 STS (NA EDITION)





| Belt No. |  | No. of Belts | OEM  Part No. | PIX  Part No. |
|----------|---|--------------|--|--|
| 1 | Clean Grain Elevator | 1 | H223230 | A-H223230 |
| 2 | Right Hand Jackshaft (rear) | 1 | H154723 | A-H154723 |
| 3 | Right Hand Jackshaft (front) | 2 | AH150678 | A-AH150678 |
| 4 | Feed Accelerator, Standardspeed | 1 | H236472 | A-H236472 |
| 4 | Feed Accelerator, Slow Speed | 1 | H221732 | A-H221732 |
| 4 | Feed Accelerator, High Speed | 1 | H221733 | A-H221733 |
| 4 | Feed Accelerator, High Speed | 1 | H230230 | A-H230230 |
| 5 | Shoe Fan Andconveyor Augers | 1 | H175587 | A-H175587 |
| 6 | Cleaning Fan | 1 | H230909 | A-H230909 |
| 6 | Cleaning Fan, Slow Speed | 1 | H215389 | A-H215389 |
| 7 | Tailings Auger Andelevator | 1 | H154731 | A-H154731 |
| 8 | Header & Reelpump, High Capacity | 1 | H156541 | A-H156541 |
| 8 | Header & Reelpump, Multi-speed | 1 | H229018 | A-H229018 |
| | Feeder House Drive | 2 | | |
| 9 | Unloading Auger System | 1 | Ah160080 | A-AH160080 |
| 10 | Variable Rotor Drive | 1 | H208431 | A-H208431 |
| 11 | Discharge Beater | 1 | H219182 | A-H219182 |
| 11 | Discharge Beater (cis) | 1 | H168301 | A-H168301 |
| 12 | Countershaft, Discharge Beater & Chopper (Standard Duty) | 1 | HXE10556 | A-HXE10556 |
| 12 | Countershaft, Discharge Beater & Chopper (Heavy Duty) | 1 | HXE10501 | A-HXE10501 |
| 12 | Countershaft, Discharge Beater & Chopper (CIS) | 1 | HXE15671 | A-HXE15671 |
| 13 | Straw Chopper | 1 | H223212 | A-H223212 |
| 13 | Straw Chopper (cis) | 1 | H235564 | A-H235564 |
| 14 | Fixed Speed Feeder House (extra Heavy Duty) | 1 | H174885 | A-H174885 |
| 14 | Fixed Speed Feeder House Multi-speed Feeder House Drive | 1 | H229019 | A-H229019 |

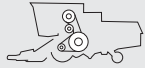

JOHN DEERE 9880

| Belt No. |  | No. of Belts | OEM  Part No. | PIX  Part No. |
|----------|---|--------------|--|--|
| 2 | Separator Variatorhigh Hp | 1 | H207851 | A-H207851 |
| 3 | Separator Variator | 1 | H208431 | A-H208431 |
| 4 | Straw Chopper Jackshaft Drive | 1 | H225035 | A-H225035 |
| 5 | Straw Chopper Drive | 1 | H217352 | A-H217352 |



JOHN DEERE 9900



| Belt No. |  | No. of Belts | OEM  Part No. | PIX  Part No. |
|----------|---|--------------|--|--|
| 1 | Compressor | 1 | N113642 | A-N113642 |
| 2 | Fan/alternator | 1 | AT23317 | A-AT23317 |
| 3 | Fan Rotor | 1 | N124460 | A-N124460 |
| 4 | Hydraulic Pump | 1 | N115368 | A-N115368 |
| 5 | Hydraulic Pump | 1 | N117398 | A-N117398 |
| 6 | Unit Drive (left Hand) | 1 | N111527 | A-N111527 |
| 7 | Unit Drive (right Hand) | 1 | N121116 | A-N121116 |

JOHN DEERE 9910

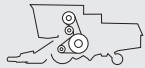

| Belt No. |  | No. of Belts | OEM  Part No. | PIX  Part No. |
|----------|---|--------------|--|--|
| 1 | Fan | 1 | N129368 | A-N129368 |
| 2 | Fan / Alternator | 1 | AN273251 | A-AN273251 |
| 3 | Hydraulic Pump | 1 | N117398 | A-N117398 |
| 4 | Unit Drive (Left Hand) | 1 | N111527 | A-N111527 |
| 5 | Unit Drive (Right Hand) | 1 | N121116 | A-N121116 |
| 6 | Water Pump | 1 | M1900T | A-M1900T |

JOHN DEERE 9920



| Belt No. |  | No. of Belts | OEM  Part No. | PIX  Part No. |
|----------|---|--------------|--|--|
| 1 | Condenser | 1 | N117674 | A-N117674 |
| 3 | Fan Drive | 1 | N129368 | A-N129368 |
| 4 | Hydraulic Pump Drive | 1 | E61326 | A-E61326 |
| 5 | Unit Drive Left Hand | 1 | N111527 | A-N111527 |
| 6 | Unit Drive Right Hand | 1 | N121116 | A-N121116 |
| 7 | Water Line | 1 | M1900T | A-M1900T |

| Belt No. |  | No. of Belts | OEM  Part No. | PIX  Part No. |
|----------|---|--------------|--|--|
| 1 | Condenser | 1 | N117674 | A-N117674 |
| 3 | Fan Drive | 1 | N129368 | A-N129368 |
| 4 | Hydraulic Pump Drive | 1 | E61326 | A-E61326 |
| 5 | Lubrication Pump | 1 | M41592 | A-M41592 |
| 6 | Unit Drive Left Hand | 1 | N111527 | A-N111527 |
| 7 | Unit Drive Right Hand | 1 | N121116 | A-N121116 |
| 8 | Water Line | 1 | M1900T | A-M1900T |



JOHN DEERE 9935

| Belt No. |  | No. of Belts | OEM  Part No. | PIX  Part No. |
|----------|---|--------------|--|--|
| 1 | - | 1 | R123465 | A-R123465 |
| 2 | - | 1 | N220907 | A-N220907 |



JOHN DEERE 9940

| Belt No. |  | No. of Belts | OEM  Part No. | PIX  Part No. |
|----------|---|--------------|--|--|
| 1 | Compressor Drive | 1 | R71602 | A-R71602 |
| 2 | Alternator And Fan Drive | 2 | AR86496 | A-AR86496 |
| 3 | Fan Drive | 1 | N193822 | A-N193822 |
| 4 | Hydrostatic Pump Drive | 1 | N190043 | A-N190043 |
| 5 | Unit Drive | 2 | AN190948 | A-AN190948 |
| 6 | Water Line | 1 | N31649 | A-N31649 |



JOHN DEERE 9950

| Belt No. |  | No. of Belts | OEM  Part No. | PIX  Part No. |
|----------|---|--------------|--|--|
| 1 | Compressor Drive | 1 | R73189 | A-R73189 |
| 2 | Alternator And Fan Drive | 2 | RE29018 | A-RE29018 |
| 3 | Fan Drive | 1 | N193822 | A-N193822 |
| 4 | Hydrostatic Pump Drive | 1 | N190043 | A-N190043 |
| 5 | Lubrication Pump | 1 | M42485 | A-M42485 |
| 6 | Unit Drive | 2 | AN190948 | A-AN190948 |
| 7 | Waterpump Drive | 1 | N31649 | A-N31649 |

JOHN DEERE 9960

| Belt No. |  | No. of Belts | OEM  Part No. | PIX  Part No. |
|----------|---|--------------|--|--|
| 1 | COMPRESSOR DRIVE | 1 | R73189 | A-R73189 |
| 2 | ALTERNATOR AND FANDRIVE | 2 | RE29018 | A-RE29018 |
| 3 | ALTERNATOR AND FANDRIVE | 2 | RE41942 | A-RE41942 |
| 4 | FAN AIR SYSTEM | 1 | N193822 | A-N193822 |
| 5 | LUBRICATION PUMP | 1 | M82720 | A-M82720 |
| 6 | UNIT DRIVE (IN LINE) | 1 | AN194751 | A-AN194751 |
| 7 | UNIT DRIVE (IN LINE) | 2 | AH96333 | A-AH96333 |
| 8 | UNIT DRIVE (CONVENTIONAL) | 2 | AN194750 | A-AN194750 |
| 9 | UNIT DRIVE (CONVENTIONAL) | 2 | AH96333 | A-AH96333 |
| 10 | WATERPUMP DRIVE | 1 | T10552 | A-T10552 |
| 11 | - | 2 | AN194916 | A-AN194916 |
| 12 | - | 2 | An194917 | A-AN194917 |



JOHN DEERE 9970

| Belt No. |  | No. of Belts | OEM  Part No. | PIX  Part No. |
|----------|---|--------------|--|--|
| 1 | - | 1 | R116307 | A-R116307 |
| 2 | - | 2 | AN274672 | A-AN274672 |
| 3 | - | 2 | AN274673 | A-AN274673 |



JOHN DEERE 9976

| Belt No. |  | No. of Belts | OEM  Part No. | PIX  Part No. |
|----------|---|--------------|--|--|
| 3 | - | 2 | AN274215 | A-AN274215 |
| 5 | - | 1 | N274995 | A-N274995 |
| 6 | - | 2 | AN273299 | A-AN273299 |

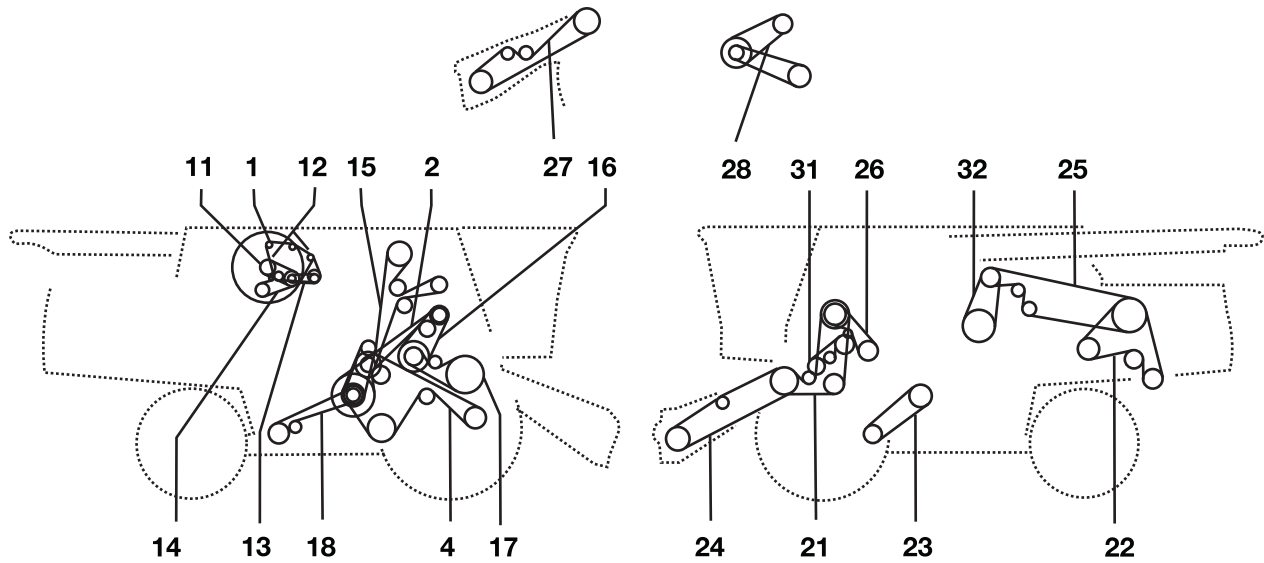

JOHN DEERE 9980

| Belt No. |  | No. of Belts | OEM  Part No. | PIX  Part No. |
|----------|---|--------------|--|--|
| 1 | CLEAN GRAIN ELEVATOR DRIVE | 1 | H158512 | A-H158512 |
| 2 | - | 2 | H154723 | A-H154723 |
| 3 | - | 2 | AH150678 | A-AH150678 |
| 4 | - | 1 | H201821 | A-H201821 |
| 5 | SHOE FAN AND CONVEYOR AUGERS | 1 | H175587 | A-H175587 |
| 6 | CLEANING FAN DRIVE | 1 | H165072 | A-H165072 |
| 8 | - | 1 | H154731 | A-H154731 |
| 9 | - | 1 | H175628 | A-H175628 |
| 10 | - | 1 | H178037 | A-H178037 |
| 11 | - | 1 | R135609 | A-R135609 |
| 12 | STRAW CHOPPER (REAR) | 2 | H156541 | A-H156541 |
| 14 | - | 2 | AH160080 | A-AH160080 |
| 16 | - | 1 | H168301 | A-H168301 |
| 17 | STRAW CHOPPER JACKSHAFT DRIVE | 1 | H174367 | A-H174367 |
| 19 | - | 2 | H174885 | A-H174885 |



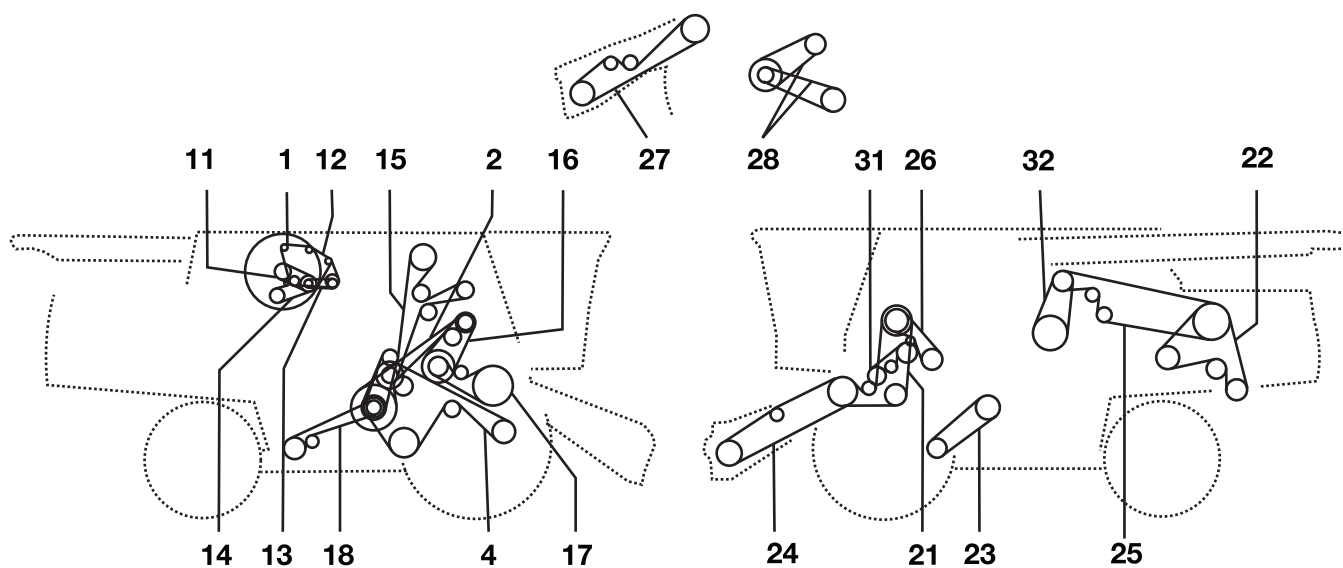

| Belt No. |  | No. of Belts | OEM  Part No. | PIX  Part No. |
|----------|---|--------------|--|--|
| 1 | Alternator Drive | 1 | H101813 | A-H101813 |
| 2 | Countershaft (secondary) | 1 | H128010 | A-H128010 |
| 4 | Straw Walker - Conveyor Augers | 1 | H131169 | A-H131169 |
| 11 | Cooling Fan | 2 | AH140623 | A-AH140623 |
| 11 | Cooling Fan | 1 | H153297 | A-H153297 |
| 13 | Rotary Screen Drive | 1 | H146636 | A-H146636 |
| 14 | Air Conditioning Compressor Drive | 1 | H134437 | A-H134437 |
| 15 | Cleaning Elevator (grain) | 1 | H141167 | A-H141167 |
| 16 | Cylinder Drive Intermediate | 1 | H115759 | A-H115759 |
| 16 | Cylinder Drive Intermediate | 1 | H162629 | A-H162629 |
| 17 | Cylinder Drive,slow Speed | 1 | H118618 | A-H118618 |
| 17 | Cylinder Drive | 1 | H115881 | A-H115881 |
| 18 | Tailings Auger Andelevator (lower) | 1 | N110085 | A-N110085 |
| 21 | Equipment Front End | 1 | H140160 | A-H140160 |
| 22 | Straw Chopper (front) | 1 | H141417 | A-H141417 |
| 23 | Fan Drive Regular (n=750-1350 Rpm) | 1 | H140404 | A-H140404 |
| 23 | Slow Speed (n=490-980 Rpm) | 1 | H137264 | A-H137264 |
| 24 | Drum Drive Variable Speed | 1 | H125711 | A-H125711 |
| 25 | Separator Drive | 1 | H141429 | A-H141429 |
| 26 | Beater Drive | 1 | H143700 | A-H143700 |
| 27 | Feeder House Fixed Speed | 1 | H126345 | A-H126345 |
| 28 | Straw Spreader Drive | 1 | E61326 | A-E61326 |
| 28 | Straw Spreader Drive | 1 | P49604 | A-P49604 |
| 28 | Chaff Spreader Drive | 1 | M95728 | A-M95728 |
| 31 | Stripper Beater | 1 | H139963 | A-H139963 |
| 32 | Unloading System | 1 | AH127866 | A-AH127866 |



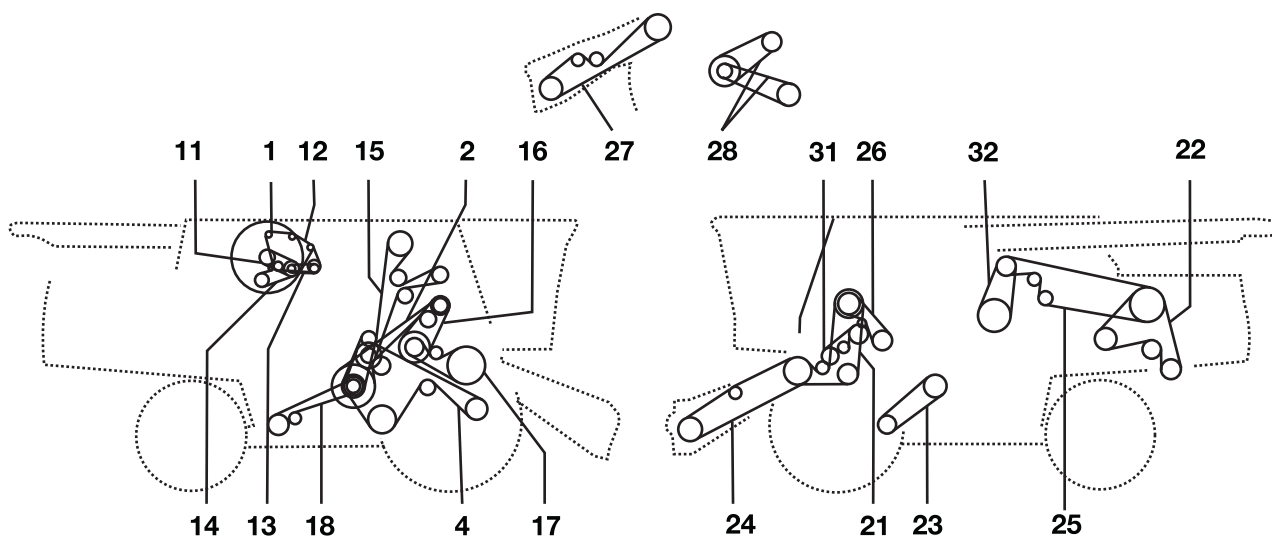

| Belt No. |  | No. of Belts | OEM  Part No. | PIX  Part No. |
|----------|---|--------------|--|--|
| 1 | Alternator Drive | 1 | H101813 | A-H101813 |
| 2 | Countershaft (secondary) | 1 | H128010 | A-H128010 |
| 4 | Straw Walker - Conveyor Augers | 1 | H131169 | A-H131169 |
| 11 | Cooling Fan | 2 | AH140623 | A-AH140623 |
| 11 | Cooling Fan | 1 | H153297 | A-H153297 |
| 13 | Rotary Screen Drive | 1 | H146636 | A-H146636 |
| 14 | Air Conditioning Compressor Drive | 1 | H134437 | A-H134437 |
| 15 | Cleaning Elevator (grain) | 1 | H141167 | A-H141167 |
| 16 | Cylinder Drive Intermediate | 1 | H115759 | A-H115759 |
| 16 | Cylinder Drive Intermediate | 1 | H162629 | A-H162629 |
| 17 | Cylinder Drive, Slow Speed | 1 | H118618 | A-H118618 |
| 17 | Cylinder Drive | 1 | H115881 | A-H115881 |
| 18 | Tailings Auger And Elevator (lower) | 1 | N110085 | A-N110085 |
| 21 | Equipment Front End | 1 | H140160 | A-H140160 |
| 22 | Straw Chopper (front) | 1 | H141417 | A-H141417 |
| 23 | Fan Drive Regular(n=750-1350 Rpm) | 1 | H140404 | A-H140404 |
| 23 | Slow Speed (n=490-980 Rpm) | 1 | H137264 | A-H137264 |
| 24 | Drum Drive Variable Speed | 1 | H125711 | A-H125711 |
| 25 | Separator Drive | 1 | H141429 | A-H141429 |
| 26 | Beater Drive | 1 | H143700 | A-H143700 |
| 27 | Feeder House Fixed Speed | 1 | H126345 | A-H126345 |
| 28 | Straw Spreader Drive | 1 | E61326 | A-E61326 |
| 28 | Straw Spreader Drive | 1 | P49604 | A-P49604 |
| 29 | Chaff Spreader Drive | 1 | M95728 | A-M95728 |
| 31 | Stripper Beater | 1 | H139963 | A-H139963 |
| 32 | Unloading System | 1 | AH127866 | A-AH127866 |





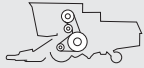

| Belt No. |  | No. of Belts | OEM  Part No. | PIX  Part No. |
|----------|---|--------------|--|--|
| 1 | Alternator Drive | 1 | H163515 | A-H163515 |
| 2 | Countershaft (secondary) | 1 | H128010 | A-H128010 |
| 4 | Straw Walker - Conveyor Augers | 1 | H131169 | A-H131169 |
| 5 | Cooling Fan | 1 | H161796 | A-H161796 |
| 7 | Rotary Screen Drive | 1 | H160406 | A-H160406 |
| 8 | Air Conditioning Compressor Drive | 1 | H134437 | A-H134437 |
| 9 | Clean Grain Elevator Drive | 1 | H160171 | A-H160171 |
| 10 | Cylinder Drive Intermediate | 1 | H162629 | A-H162629 |
| 11 | Cylinder Drive,slow Speed | 1 | H118618 | A-H118618 |
| 11 | Cylinder Drive | 1 | H115881 | A-H115881 |
| 12 | Tailings Auger Andelevator (lower) | 1 | H110085 | A-H110085 |
| 13 | Stripper Beater | 1 | H139963 | A-H139963 |
| 14 | Unloading System | 1 | AH127866 | A-AH127866 |
| 15 | Equipment Front End | 1 | H151952 | A-H151952 |
| 16 | Straw Chopper (front) | 1 | H162541 | A-H162541 |
| 17 | Slow Speed (n=490-980 Rpm) Optional | 1 | H152180 | A-H152180 |
| 17 | Fan Drive Regular (n=750-1350 Rpm) | 1 | H152146 | A-H152146 |
| 18 | Drum Drive Variable Speed | 1 | H161648 | A-H161648 |
| 19 | Separator Drive | 1 | H141429 | A-H141429 |
| 20 | Beater Drive | 1 | H143700 | A-H143700 |
| 21 | Feeder House Fixed Speed | 1 | H126345 | A-H126345 |
| 22 | Straw Spreader Drive | 1 | E61326 | A-E61326 |
| 22 | - | 1 | P49604 | A-P49604 |
| 23 | Chaff Spreader Drive | 1 | M95728 | A-M95728 |

JOHN DEERE CTS II

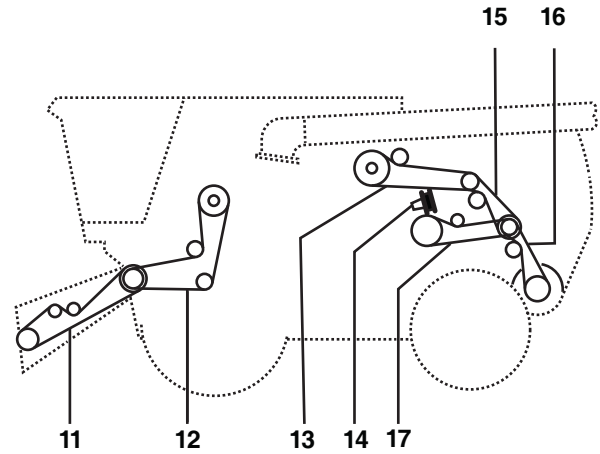
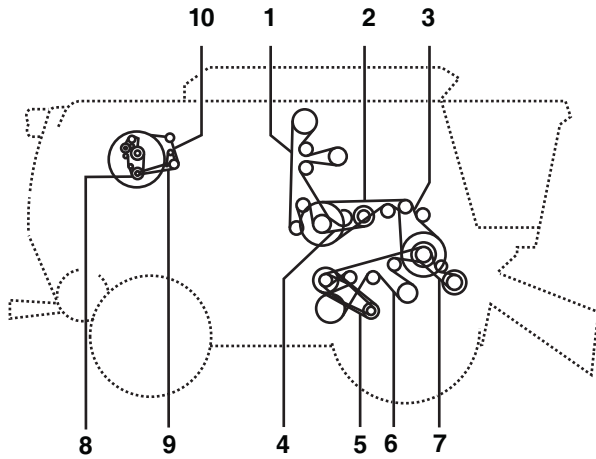
| Belt No. |  | No. of Belts | OEM  Part No. | PIX  Part No. |
|-----------------|---|---------------------|---|---|
| 1 | - | 1 | M140021 | A-M140021 |
| 2 | - | 2 | H155525 | A-H155525 |





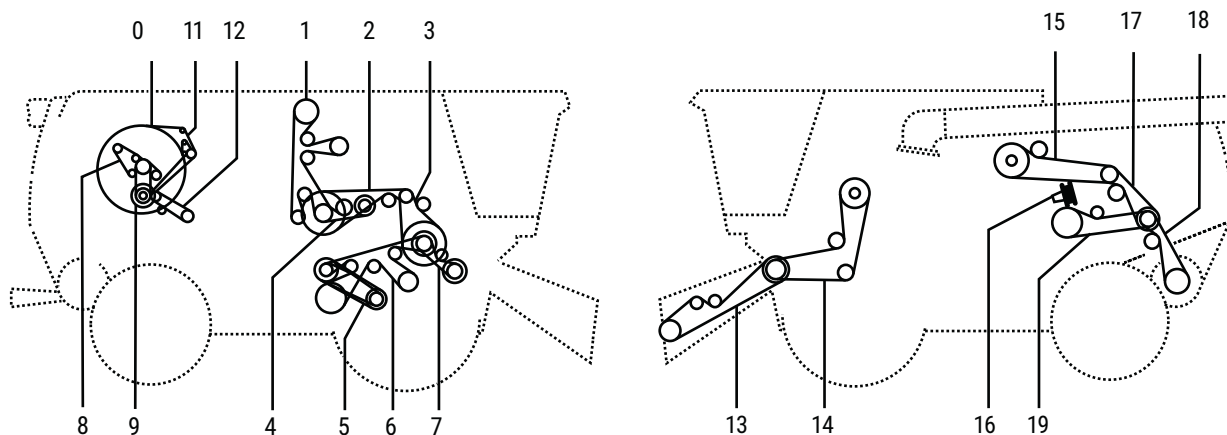

| Belt No. |  | No. of Belts | OEM  Part No. | PIX  Part No. |
|----------|---|--------------|--|--|
| 1 | Clean Grain Elevator | 1 | H218645 | A-H218645 |
| 2 | Powershaft To Elevator Jackshaft (right Hand) | 1 | H154723 | A-H154723 |
| 3 | Powershaft To Feed Accelerator Jackshaft | 2 | AXE13650 | A-AXE13650 |
| 4 | Tailings Elevator | 1 | H154731 | A-H154731 |
| 5 | Cleaning Fan (standard Speed) | 1 | HXE15594 | A-HXE15594 |
| 6 | Shoe, Conveyor Auger, Fanshaft | 1 | H175587 | A-H175587 |
| 7 | Feed Accelerator - Slow Speed - High Capacity - 320/790 Rpm | 1 | H221732 | A-H221732 |
| 7 | Feed Accelerator - Standard Speed - High Capacity - 440/800 Rpm | 1 | H236472 | A-H236472 |
| 8 | Engine Fan Andalternator Drive 6,8l | 1 | R521053 | A-R521053 |
| 9 | Rotary Screen Drive (engine Side) | 1 | H213353 | A-H213353 |
| 10 | Rotary Screen Drive (screen Side) | 1 | H221273 | A-H221273 |
| 11 | Fixed Feeder House (standard Duty) | 1 | H203474 | A-H203474 |
| 11 | Variable Feeder House (heavy Duty) | 1 | H218726 | A-H218726 |
| 12 | E-clutch To Feeder House (heavy Duty) | 1 | HXE16927 | A-HXE16927 |
| 12 | E-clutch To Feeder House (standard Duty) | 1 | HXE16928 | A-HXE16928 |
| 13 | Unloading Drive | 2 | AH160080 | A-AH160080 |
| 14 | Rotor Drive (standard Duty) | 1 | H221498 | A-H221498 |
| 15 | Pto To Straw Chopper Jackshaft | 1 | HXE15671 | A-HXE15671 |
| 16 | Straw Chopper Jackshaft To Straw Chopper | 1 | H235564 | A-H235564 |
| 17 | Discharge Beater | 1 | H219182 | A-H219182 |

JOHN DEERE S660



| Belt No. |  | No. of Belts | OEM  Part No. | PIX  Part No. |
|----------|---|--------------|--|--|
| 1 | Clean Grain Elevator | 1 | H218645 | A-H218645 |
| 2 | Powershaft To Elevator Jackshaft | 1 | H154723 | A-H154723 |
| 3 | Powershaft To Feed Accelerator Jackshaft | 2 | AH150678 | A-AH150678 |
| 4 | Tailings Elevator | 1 | H154731 | A-H154731 |
| 5 | Cleaning Fan(standard Speed) | 1 | HXE15594 | A-HXE15594 |
| 6 | Shoe, Conveyor Auger, Fan Shaft | 1 | H175587 | A-H175587 |
| 7 | Feed Accelerator - Slow Speed - High Capacity - 320/790 Rpm | 1 | H221732 | A-H221732 |
| 7 | Feed Accelerator - Standard Speed - High Capacity - 440/800 Rpm | 1 | H236472 | A-H236472 |
| 8 | Engine Alternator Drive - 9,0l | 1 | H238822 | A-H238822 |
| 9 | Engine Fan Drive 9,0L | 1 | HXE22617 | A-HXE22617 |
| 10 | Rotary Screen Drive (engine Side) | 1 | H238867 | A-H238867 |
| 11 | Rotary Screen Drive (screen Side) | 1 | H221273 | A-H221273 |
| 12 | Vacuum Fan Drive - 9,0l - Lower | 1 | HXE24086 | A-HXE24086 |
| 12 | Vacuum Fan Drive - 9,0l - Upper | 1 | HXE24085 | A-HXE24085 |
| 13 | Fixed Feeder House - Variable | 1 | H220911 | A-H220911 |
| 13 | Fixed Feeder House (heavy Duty & High Torque) | 1 | H174885 | A-H174885 |
| 13 | Variable Feeder House (heavy Duty) | 1 | H218726 | A-H218726 |
| 14 | E-clutch To Feeder House (heavy Duty) | 1 | H156541 | A-H156541 |
| 15 | Unloading Drive | 2 | AH160080 | A-AH160080 |
| 16 | Rotor Drive (standard Duty) | 1 | H221498 | A-H221498 |
| 17 | Pto To Straw Chopper Jackshaft | 1 | H241230 | A-H241230 |
| 18 | Straw Chopper Jackshaft To Straw Chopper - Fc | 1 | H241212 | A-H241212 |
| 19 | Discharge Beater | 1 | HXE15556 | A-HXE15556 |

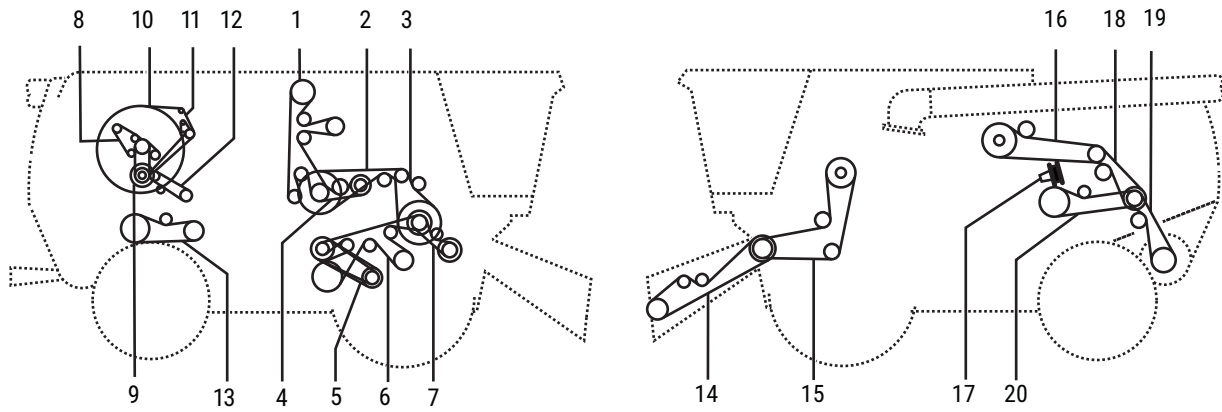

JOHN DEERE S670 - S670 HILLMASTER



| Belt No. |  | No. of Belts | OEM  Part No. | PIX  Part No. |
|----------|---|--------------|--|--|
| 1 | | 1 | H223230 | A-H223230 |
| 2 | | 1 | H154723 | A-H154723 |
| 3 | | 2 | AH150678 | A-AH150678 |
| 4 | | 1 | H154731 | A-H154731 |
| 5 | | 1 | HXE15594 | A-HXE15594 |
| 6 | | 1 | H175587 | A-H175587 |
| 7 | | 1 | H230230 | A-H230230 |
| 7 | | 1 | H221732 | A-H221732 |
| 7 | | 1 | H236472 | A-H236472 |
| 8 | | 1 | H238822 | A-H238822 |
| 9 | | 1 | HXE22617 | A-HXE22617 |
| 10 | | 1 | H238867 | A-H238867 |
| 11 | | 1 | H221273 | A-H221273 |
| 12 | | 1 | HXE24086 | A-HXE24086 |
| 12 | | 1 | HXE24085 | A-HXE24085 |
| 13 | | 1 | H240895 | A-H240895 |
| 14 | | 1 | H220911 | A-H220911 |
| 14 | | 1 | H229019 | A-H229019 |
| 14 | | 1 | H174885 | A-H174885 |
| 15 | | 1 | H156541 | A-H156541 |
| 15 | | 1 | H229018 | A-H229018 |
| 16 | | 2 | AH160080 | A-AH160080 |
| 17 | | 1 | H208431 | A-H208431 |
| 17 | | 1 | HXE46027 | A-HXE46027 |
| 18 | | 1 | H241000 | A-H241000 |
| 18 | | 1 | H241230 | A-H241230 |
| 19 | | 1 | H241212 | A-H241212 |
| 19 | | 1 | H240974 | A-H240974 |
| 19 | | 1 | H240972 | A-H240972 |
| 20 | | 2 | AH236689 | A-AH236689 |

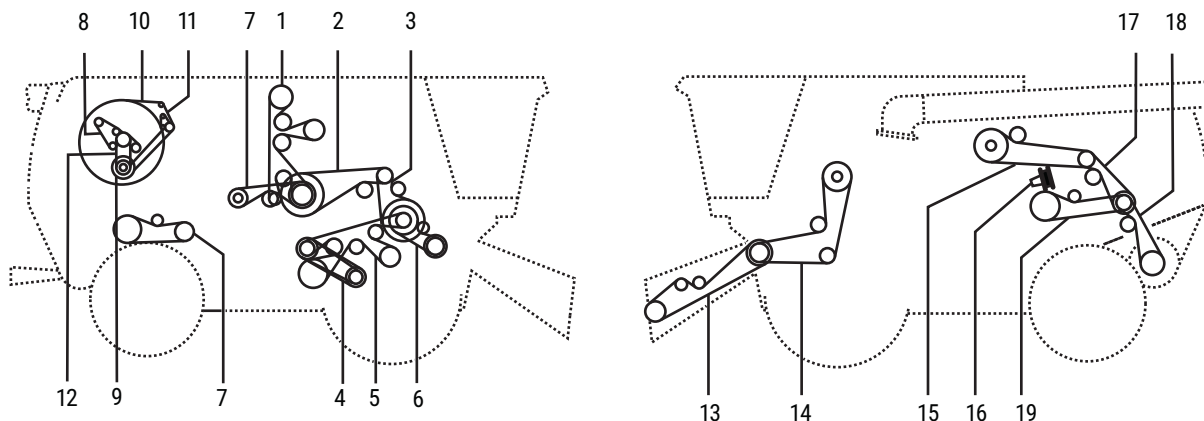

JOHN DEERE S680 - S690



| Belt No. |  | No. of Belts | OEM  Part No. | PIX  Part No. |
|----------|---|--------------|--|--|
| 1 | Clean Grain Elevator | 1 | H223230 | A-H223230 |
| 2 | Powershaft To Elevator Jackshaft | 1 | H154723 | A-H154723 |
| 3 | Powershaft To Feed Accelerator Jackshaft | 2 | AH150678 | A-AH150678 |
| 4 | Cleaning Fan(standard Speed) | 1 | HXE15594 | A-HXE15594 |
| 5 | Shoe, Conveyor Auger, Fan Shaft | 1 | H175587 | A-H175587 |
| 6 | Feed Accelerator - Slow Speed - High Capacity - 320/790 Rpm | 1 | H221732 | A-H221732 |
| 6 | Feed Accelerator - Standard Speed - High Capacity - 440/800 Rpm | 1 | H236472 | A-H236472 |
| 6 | Feed Accelerator - High Speed - High Capacity - 520/1000 RPM | 1 | HXE54503 | A-HXE54503 |
| 7 | Retresher Tailings | 1 | H240895 | A-H240895 |
| 8 | Engine Alternator Drive - 13,5l | 1 | H238831 | A-H238831 |
| 8 | Engine Alternator Drive - 13,5l | 1 | R503505 | A-R503505 |
| 9 | Engine Fan Drive 13,5l | 1 | HXE32548 | A-HXE32548 |
| 10 | Rotary Screen Drive (engine Side) | 1 | H238867 | A-H238867 |
| 11 | Rotary Screen Drive (screen Side) | 1 | H221273 | A-H221273 |
| 12 | Engine Fan And Alternator Drive | 1 | R503312 | A-R503312 |
| 13 | Fixed Feeder House (5 Speed) | 1 | H229019 | A-H229019 |
| 13 | Fixed Feeder House (heavy Duty & High Torque) | 1 | H174885 | A-H174885 |
| 14 | E-clutch To Feeder House (heavy Duty) | 1 | H156541 | A-H156541 |
| 14 | Fixed Feeder House - Variable | 1 | H220911 | A-H220911 |
| 15 | Unloading Drive | 2 | AH233198 | A-AH233198 |
| 16 | Rotor Drive (heavy Duty - Large Sheave) | 1 | H208431 | A-H208431 |
| 17 | Pto To Straw Chopper Jackshaft - 13,5l Xfc | 1 | H240888 | A-H240888 |
| 17 | Pto To Straw Chopper Jackshaft | 1 | H241230 | A-H241230 |
| 18 | Straw Chopper Jackshaft To Straw Chopper - Fc | 1 | H241212 | A-H241212 |
| 18 | Straw Chopper Jackshaft To Straw Chopper - Xfc | 1 | H240974 | A-H240974 |
| 18 | Straw Chopper Jackshaft To Straw Chopper - Xfc | 1 | H240972 | A-H240972 |
| 19 | Discharge Beater | 2 | AH236689 | A-AH236689 |

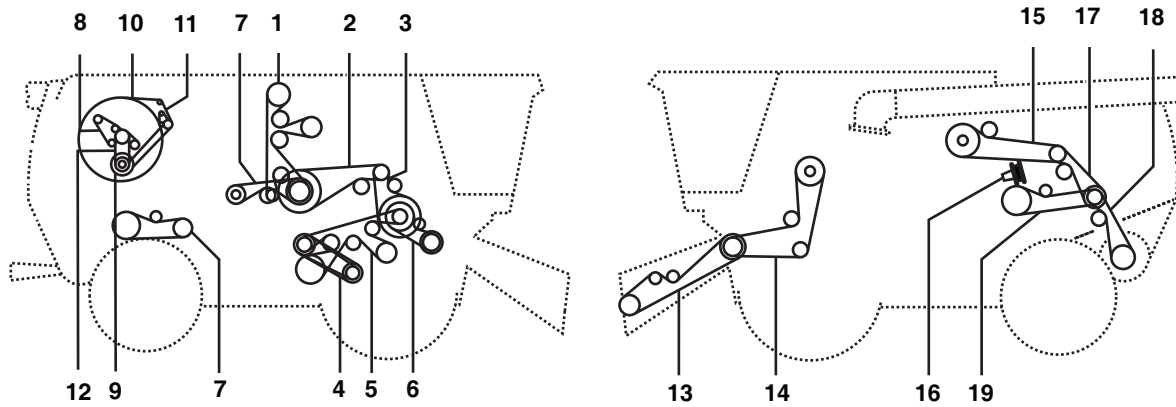

JOHN DEERE S680 HILLMASTER - S690 HILLMASTER



| Belt No. |  | No. of Belts | OEM  Part No. | PIX  Part No. |
|----------|---|--------------|--|--|
| 1 | | 1 | HXE20763 | A-HXE20763 |
| 2 | | 1 | H154723 | A-H154723 |
| 3 | | 2 | AH150678 | A-AH150678 |
| 4 | | 1 | HXE15594 | A-HXE15594 |
| 5 | | 1 | H175587 | A-H175587 |
| 6 | | 1 | H230230 | A-H230230 |
| 6 | | 1 | H221732 | A-H221732 |
| 6 | | 1 | H236472 | A-H236472 |
| 7 | | 1 | H240895 | A-H240895 |
| 8 | | 1 | H238831 | A-H238831 |
| 8 | | 1 | R503505 | A-R503505 |
| 9 | | 1 | HXE32548 | A-HXE32548 |
| 10 | | 1 | H238867 | A-H238867 |
| 11 | | 1 | H221273 | A-H221273 |
| 12 | | 1 | R503312 | A-R503312 |
| 13 | | 1 | H229019 | A-H229019 |
| 13 | | 1 | H174885 | A-H174885 |
| 14 | | 1 | H156541 | A-H156541 |
| 14 | | 1 | H229018 | A-H229018 |
| 15 | | 2 | AH233198 | A-AH233198 |
| 16 | | 1 | H208431 | A-H208431 |
| 17 | | 1 | H241230 | A-H241230 |
| 17 | | 1 | H240888 | A-H240888 |
| 18 | | 1 | H241212 | A-H241212 |
| 18 | | 1 | H240974 | A-H240974 |
| 18 | | 1 | H240972 | A-H240972 |
| 19 | | 2 | AH236689 | A-AH236689 |

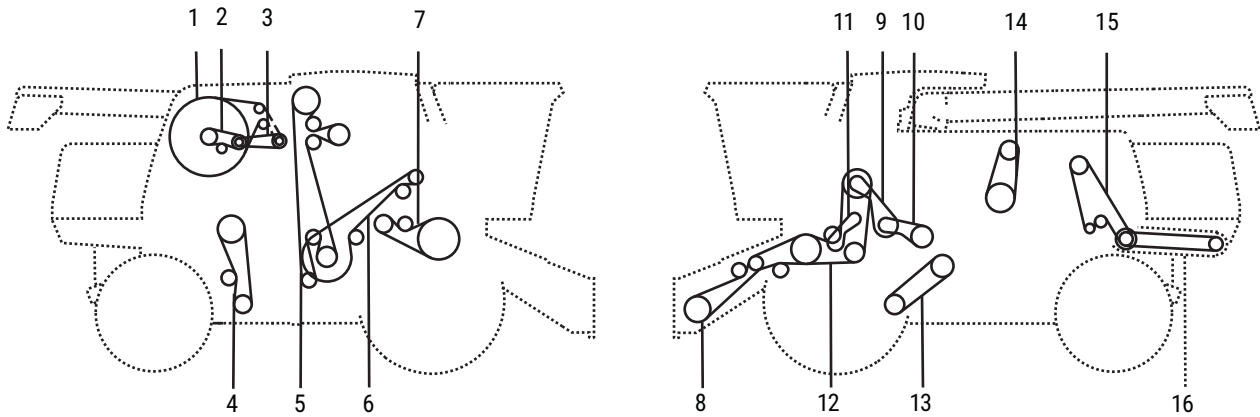

JOHN DEERE T550 - T560 (EUROPEAN EDITION)



| Belt No. |  | No. of Belts | OEM  Part No. | PIX  Part No. |
|----------|---|--------------|--|--|
| 1 | - | 1 | H175628 | A-H175628 |
| 2 | - | 1 | H174455 | A-H174455 |
| 3 | - | 1 | H146636 | A-H146636 |
| 4 | - | 1 | Z59557 | A-Z59557 |
| 5 | - | 1 | H141166 | A-H141166 |
| 6 | - | 1 | H128010 | A-H128010 |
| 7 | - | 1 | H115881 | A-H115881 |
| 8 | - | 1 | H176766 | A-H176766 |
| 8 | For Hillmaster Only | 1 | H202821 | A-H202821 |
| 8 | - | 1 | HXE12426 | A-HXE12426 |
| 8 | - | 1 | HXE12427 | A-HXE12427 |
| 9 | For N=450 Rpm - 3 Grooves | 1 | Z103844 | A-Z103844 |
| 10 | For N=900 Rpm - 2 Grooves | 1 | Z103845 | A-Z103845 |
| 11 | - | 1 | H139963 | A-H139963 |
| 12 | - | 1 | H176765 | A-H176765 |
| 12 | - | 1 | H177383 | A-H177383 |
| 13 | - | 1 | H152146 | A-H152146 |
| 14 | - | 2 | AH158880 | A-AH158880 |
| 15 | - | 1 | H177177 | A-H177177 |
| 16 | For Corn | 1 | H177178 | A-H177178 |
| 16 | - | 1 | Z59286 | A-Z59286 |

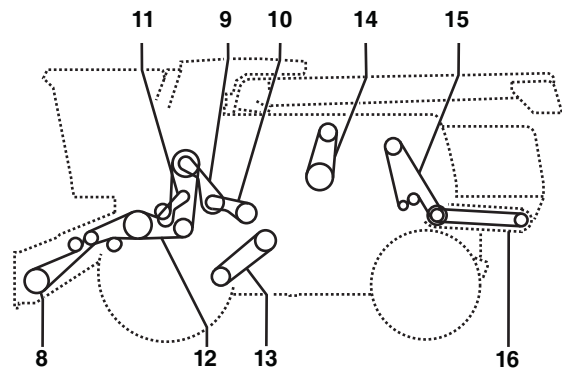
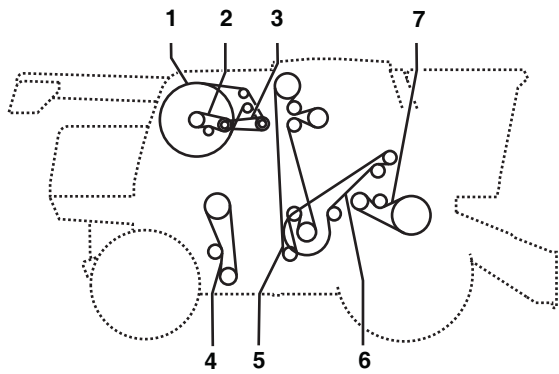

JOHN DEERE T660 - T670 - T670 (NA EDITION)



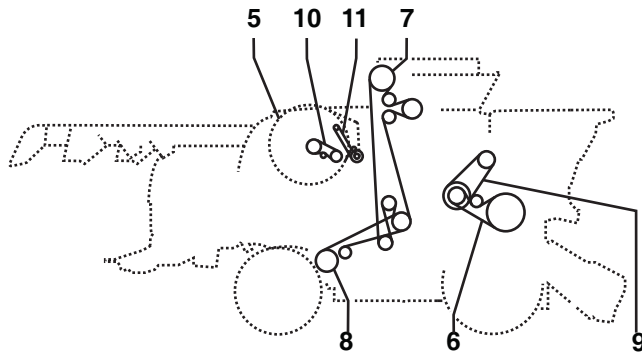
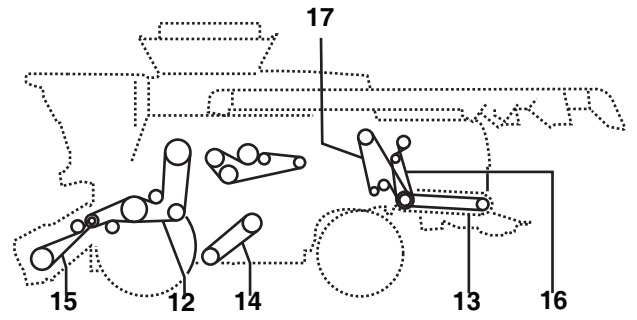
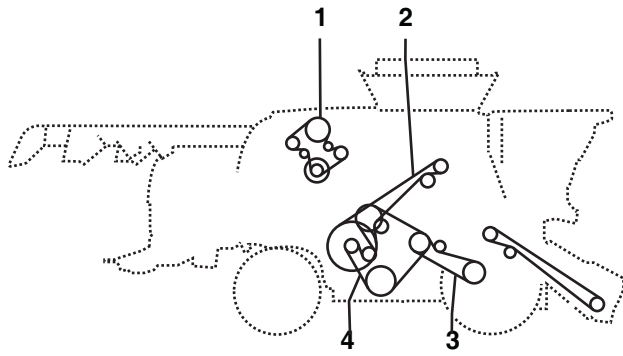

| Belt No. | | No. of Belts | OEM  Part No. | PIX  Part No. |
|----------|---------------------------|--------------|--|--|
| 1 | - | 1 | H175628 | A-H175628 |
| 2 | - | 1 | H174455 | A-H174455 |
| 3 | - | 1 | H146636 | A-H146636 |
| 4 | - | 1 | Z59557 | A-Z59557 |
| 5 | - | 1 | H141166 | A-H141166 |
| 6 | - | 1 | H128010 | A-H128010 |
| 7 | - | 1 | H115881 | A-H115881 |
| 8 | - | 1 | H176766 | A-H176766 |
| 8 | For Hillmaster Only | 1 | H202821 | A-H202821 |
| 8 | - | 1 | HXE12426 | A-HXE12426 |
| 8 | - | 1 | HXE12427 | A-HXE12427 |
| 9 | For N=450 Rpm - 3 Grooves | 1 | Z103844 | A-Z103844 |
| 10 | For N=900 Rpm - 2 Grooves | 1 | Z103845 | A-Z103845 |
| 11 | - | 1 | H139963 | A-H139963 |
| 12 | - | 1 | H176765 | A-H176765 |
| 12 | - | 1 | HXE12425 | A-HXE12425 |
| 13 | - | 1 | H152146 | A-H152146 |
| 14 | - | 2 | AH158880 | A-AH158880 |
| 15 | - | 1 | H177177 | A-H177177 |
| 16 | For Corn | 1 | H177178 | A-H177178 |
| 16 | - | 1 | Z59286 | A-Z59286 |
| 17 | - | 1 | Z59286 | A-Z59286 |

JOHN DEERE W650



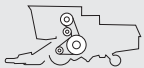

| Belt No. | | No. of Belts | OEM  Part No. | PIX  Part No. |
|----------|---|--------------|--|--|
| 1 | - | 1 | R504618 | A-R504618 |
| 2 | - | 1 | H128010 | A-H128010 |
| 3 | - | 1 | Z67285 | A-Z67285 |
| 4 | - | 1 | Z58752 | A-Z58752 |
| 5 | - | 1 | H175628 | A-H175628 |
| 6 | - | 1 | H115881 | A-H115881 |
| 7 | - | 1 | HXE51300 | A-HXE51300 |
| 8 | - | 1 | N110085 | A-N110085 |
| 9 | - | 1 | H210476 | A-H210476 |
| 10 | - | 1 | H177186 | A-H177186 |
| 11 | - | 1 | H146636 | A-H146636 |
| 12 | - | 1 | HXE12425 | A-HXE12425 |
| 13 | - | 1 | Z59286 | A-Z59286 |
| 14 | - | 1 | H152146 | A-H152146 |
| 15 | - | 1 | HXE12426 | A-HXE12426 |
| 15 | - | 1 | HXE12427 | A-HXE12427 |
| 16 | - | 1 | Z78834 | A-Z78834 |
| 17 | - | 1 | H177177 | A-H177177 |

JOHN DEERE WINDROWER 2270 - 2280

| Belt No. |  | No. of Belts | OEM  Part No. | PIX  Part No. |
|----------|---|--------------|--|--|
| 1 | Compressor Drive | 1 | E50973 | A-E50973 |
| 2 | Alternator and Fan Drive | 1 | R97758 | A-R97758 |
| 3 | Platform Drive | 1 | E50873 | A-E50873 |
| 4 | Platform Drive | 1 | E58967 | A-E58967 |



JOHN DEERE WINDROWER 2320

| Belt No. |  | No. of Belts | OEM  Part No. | PIX  Part No. |
|----------|---|--------------|--|--|
| 1 | Engine Fan Drive (Gas Engine) | 1 | E50973 | A-E50973 |
| 2 | Governor Drive (Gas Engine) | 1 | E57428 | A-E57428 |
| 3 | Compressor Drive (Gas Engine) | 1 | E63457 | A-E63457 |
| 4 | Platform Drive (Gas Engine) | 1 | E56262 | A-E56262 |

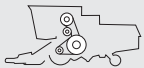

JOHN DEERE WINDROWER 2360

| Belt No. |  | No. of Belts | OEM  Part No. | PIX  Part No. |
|----------|---|--------------|--|--|
| 3 | Governor (Gas Engine) | 1 | E57428 | A-E57428 |



JOHN DEERE WINDROWER 2420

| Belt No. |  | No. of Belts | OEM  Part No. | PIX  Part No. |
|----------|---|--------------|--|--|
| 1 | Compressor Drive (Gas Engine) | 1 | E63457 | A-E63457 |
| 2 | Engine Fan Drive (Diesel Engine) | 1 | R97758 | A-R97758 |
| 3 | Fan And Compressor(Gas Engine) | 1 | E50973 | A-E50973 |
| 4 | Governor Drive (Gas Engine) | 1 | E57428 | A-E57428 |
| 5 | Platform Drive (Diesel Engine) | 1 | E56262 | A-E56262 |



KRONE BIG X 500 (700000 - 773000)

| Belt No. |  | No. of Belts | OEM  Part No. | PIX  Part No. |
|----------|---|--------------|--|--|
| 2 | Grain Conditionercpl Tafel 31 - 37 | 1 | 2168800 | A-2168800 |
| 3 | Cracker Drive / Tensioning Device | 1 | 2168800 | A-2168800 |
| 6 | Sieve Drum | 1 | 2253610 | A-2253610 |



KRONE BIG X 650 (716400 - 718510)

| Belt No. |  | No. of Belts | OEM  Part No. | PIX  Part No. |
|----------|---|--------------|--|--|
| 1 | Main Drive | 1 | 2279101 | A-2279101 |
| 2 | Grain Conditionercpl Tafel 33 - 39 | 1 | 2168800 | A-2168800 |
| 3 | Cracker Drive / Tensioning Device | 1 | 2168800 | A-2168800 |
| 4 | Diesel Engine / Clutch / Air Conditioner Drive | 1 | 2282330 | A-2282330 |
| 6 | Suction System Drive | 1 | 2253560 | A-2253560 |
| 7 | Sieve Drum | 1 | 2253610 | A-2253610 |

KRONE BIG X 800 (701805 - 750480)

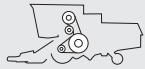

| Belt No. |  | No. of Belts | OEM  Part No. | PIX  Part No. |
|----------|---|--------------|--|--|
| 2 | Grain Conditionercpl Tafel 31 - 37 | 1 | 2168800 | A-2168800 |
| 3 | Cracker Drive / Tensioning Device | 1 | 2168800 | A-2168800 |

KRONE BIG X 1000 (701805 - 750480)

| Belt No. |  | No. of Belts | OEM  Part No. | PIX  Part No. |
|----------|---|--------------|--|--|
| 2 | Grain Conditionercpl Tafel 31 - 37 | 1 | 2168800 | A-2168800 |
| 3 | Cracker Drive / Tensioning Device | 1 | 2168800 | A-2168800 |

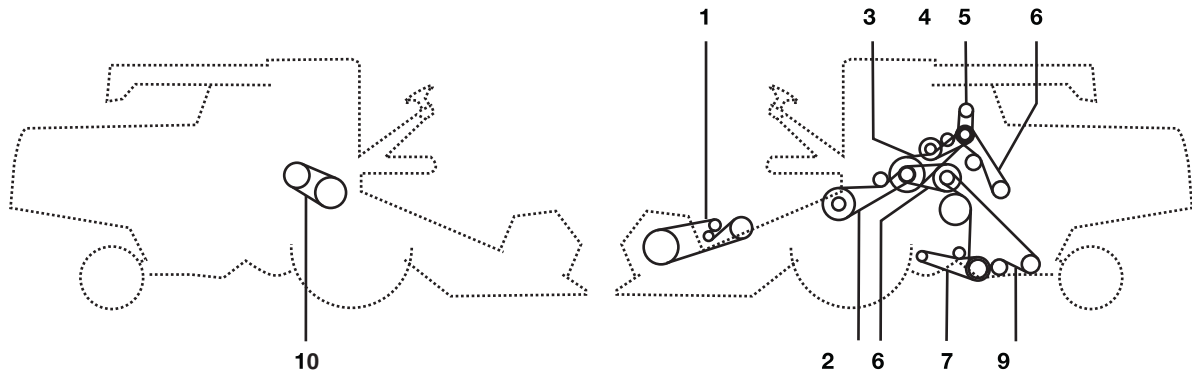
LAVERDA 3200



| Belt No. |  | No. of Belts | OEM  Part No. | PIX  Part No. |
|----------|---|--------------|--|--|
| 1 | Reel Drive | 1 | 340433458 | A-340433458 |
| 2 | Elevator Drive (upper) Shaft | 1 | 340433428 | A-340433428 |
| 4 | Hydraulic Pump Drive | 1 | 340432232 | A-340432232 |
| 5 | Auger Drive | 1 | 340433252 | A-340433252 |
| 8 | Return Drive | 1 | 340433412 | A-340433412 |
| 10 | Cylinder Variator Drive | 1 | 340435138 | A-340435138 |



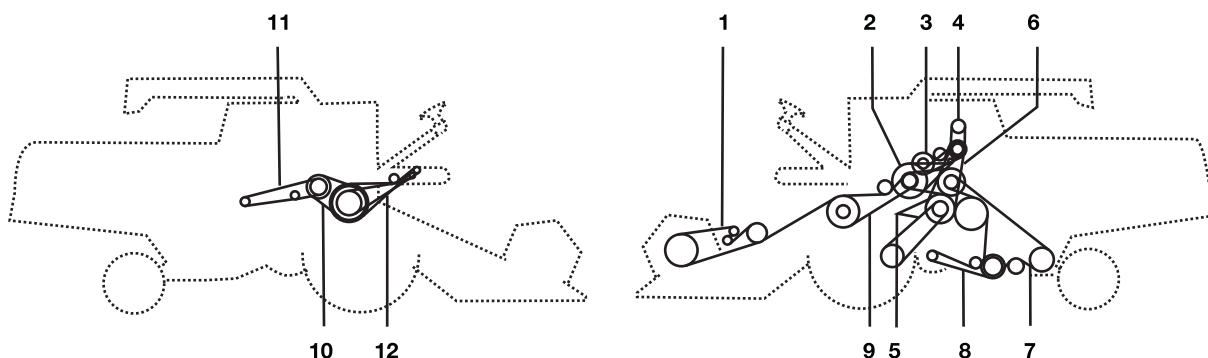

LAVERDA 3300

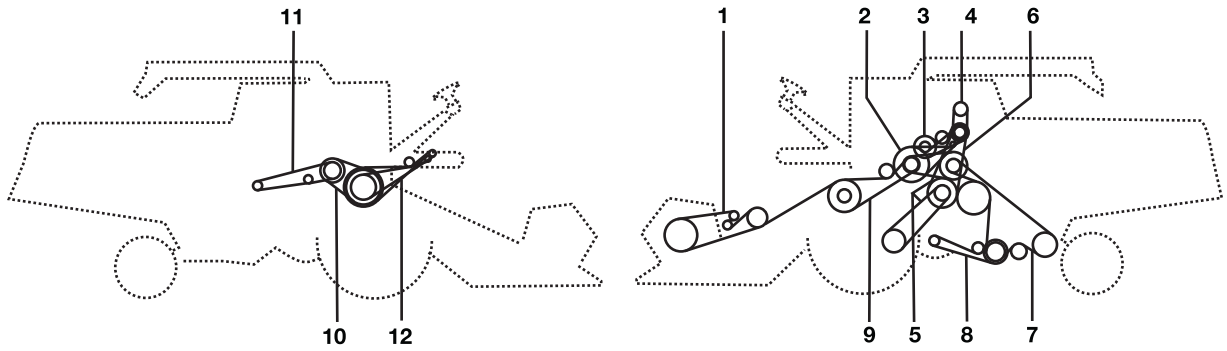

| Belt No. |  | No. of Belts | OEM  Part No. | PIX  Part No. |
|----------|---|--------------|--|--|
| 1 | Reel Drive | 1 | 340433458 | A-340433458 |
| 3 | Unloading System - Vibrator | 1 | 340433980 | A-340433980 |
| 3 | Clean Grain Elevator U-joint Loading Auger | 1 | E60212 | A-E60212 |
| 3 | Clean Grain Elevator Drive | 1 | H87648 | A-H87648 |
| 4 | Hydraulic Pump Drive | 1 | 340433223 | A-340433223 |
| 4 | Clean Grain Elevator Countershaft | 1 | H23817 | A-H23817 |
| 5 | Traction Variator Drive | 1 | 340435120 | A-340435120 |
| 6 | Return Drive | 1 | 340433412 | A-340433412 |
| 6 | Cleaning Fandrive | 1 | H80726 | A-H80726 |
| 7 | Air Conditioning Compressor Drive | 1 | H86273 | A-H86273 |
| 7 | Air Conditioning Compressor Drive | 1 | H81742 | A-H81742 |
| 7 | Air Conditioning Compressor Drive 292 | 1 | H80896 | A-H80896 |
| 7 | Straw Walker - Auger Drive | 1 | 340433970 | A-340433970 |
| 7 | Air Conditioning Compressor Drive | 1 | H63772 | A-H63772 |
| 8 | Main Fan | 1 | 340433283 | A-340433283 |
| 9 | Cylinder | 3 | AH80500 | A-AH80500 |
| 9 | Elevator Drive (upper) Shaft | 1 | 340433432 | A-340433432 |
| 10 | Engine Fan Drive | 1 | H79236 | A-H79236 |
| 10 | Engine Fan Cab (with A/c Compressor Drive) | 1 | H86271 | A-H86271 |
| 10 | Cylinder Variator drive | 1 | 340435138 | A-340435138 |
| 11 | Engine Fan Countershaft | 1 | H79235 | A-H79235 |
| 11 | Fan Drive Variable Speed | 1 | 340433176 | A-340433176 |
| 12 | Straw Chopper (front) | 1 | H20407 | A-H20407 |
| 13 | Hydrostatic Reel Pump | 1 | H77683 | A-H77683 |
| 17 | Platform And Feeder House (upper) | 1 | H76028 | A-H76028 |
| 18 | Countershaft (primary) | 2 | AH98052 | A-AH98052 |
| 19 | Propulsion Drive (lower) | 1 | H75911 | A-H75911 |
| 20 | Propulsion Drive (upper) | 1 | H75911 | A-H75911 |
| 21 | Straw Chopper Drive (rear) | 1 | H79787 | A-H79787 |
| 22 | Rotary Deflector | 1 | H86039 | A-H86039 |
| 22 | Rotary Deflector | 1 | H86060 | A-H86060 |
| 23 | Rotary Screen Drive | 1 | H86259 | A-H86259 |
| 24 | Countershaft (secondary) | 1 | H138762 | A-H138762 |
| 25 | Shoe Supply Augers (grain) | 1 | H79285 | A-H79285 |
| 26 | Straw Spreader Drive | 1 | H80159 | A-H80159 |
| 27 | Tailings Auger (lower) | 1 | E63031 | A-E63031 |
| 28 | Unloading Auger Countershaft | 1 | H76136 | A-H76136 |
| 29 | Alternator & Waterpump Drive | 1 | H80897 | A-H80897 |

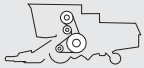

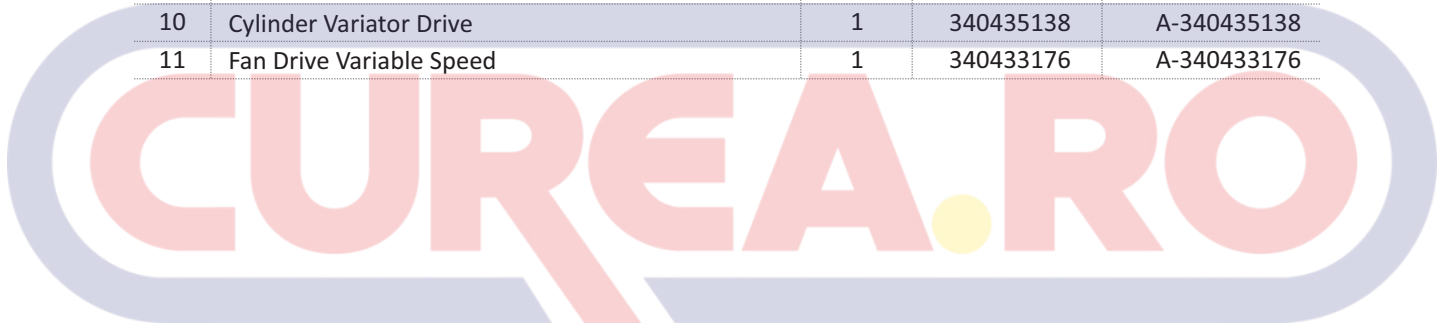

| Belt No. |  | No. of Belts | OEM  Part No. | PIX  Part No. |
|----------|---|--------------|--|--|
| 1 | | 1 | 340433458 | A-340433458 |
| 3 | | 1 | 340433252 | A-340433252 |
| 4 | | 1 | 340433239 | A-340433239 |
| 5 | | 1 | 344311212 | A-344311212 |
| 6 | | 1 | 340433412 | A-340433412 |
| 7 | | 1 | 340433970 | A-340433970 |
| 8 | | 1 | 340433283 | A-340433283 |
| 9 | | 1 | 340433432 | A-340433432 |
| 10 | | 1 | 340435138 | A-340435138 |
| 11 | | 1 | 340433176 | A-340433176 |



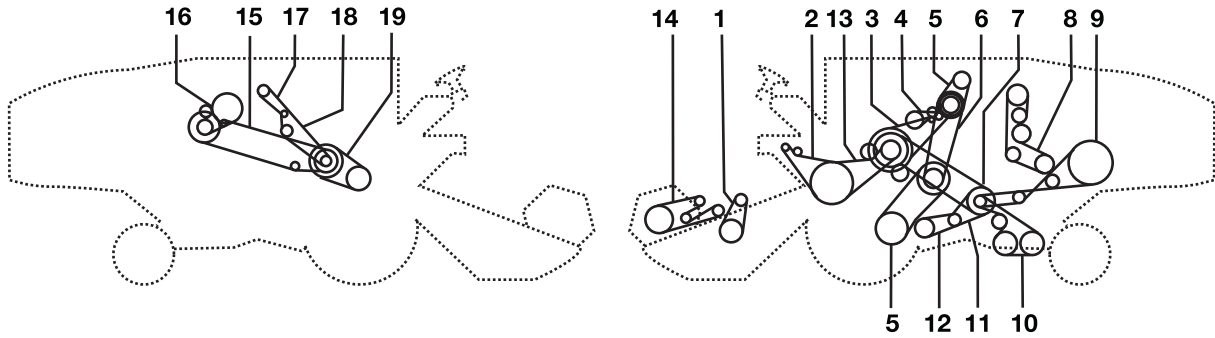

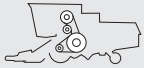
LAVERDA 3350 (EX M 112)



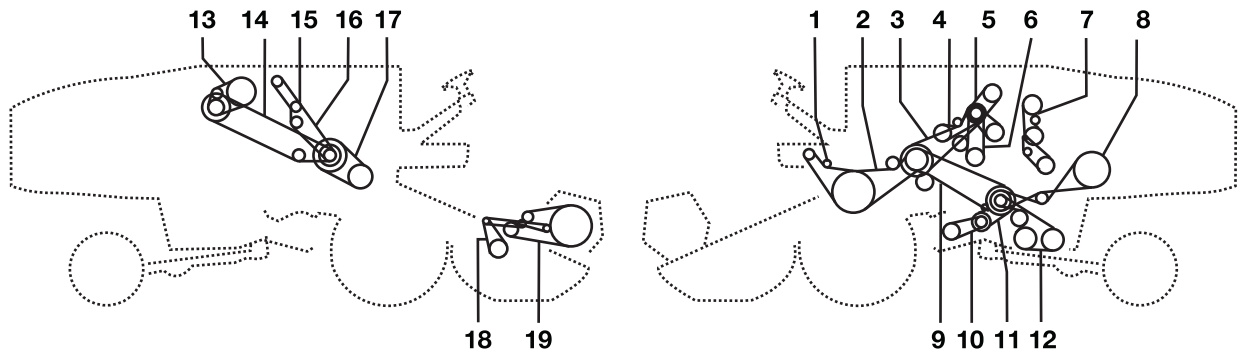

| Belt No. |  | No. of Belts | OEM  Part No. | PIX  Part No. |
|----------|---|--------------|--|--|
| 1 | Reel Drive Variable Speed (1978) | 1 | 340434138 | A-340434138 |
| 1 | Reel Drive Variable Speed | 1 | 340434140 | A-340434140 |
| 2 | Blower Drive | 1 | 340433182 | A-340433182 |
| 3 | Cylinder Variator drive | 1 | 344311221 | A-344311221 |
| 3 | Converter Drive | 1 | 340433418 | A-340433418 |
| 4 | Threshing Drum Variator drive | 1 | 344311222 | A-344311222 |
| 4 | Auger Drive | 1 | 340433417 | A-340433417 |
| 6 | Oil Pump Drive | 1 | 340432243 | A-340432243 |
| 6 | Hydraulic Pump Drive | 1 | 340433244 | A-340433244 |
| 7 | Return Drive | 1 | 340433537 | A-340433537 |
| 8 | Fan Drive | 1 | 340433289 | A-340433289 |
| 9 | Straw Walker Drive | 1 | 340433455 | A-340433455 |
| 10 | Tailings Auger Drive | 1 | 340433430 | A-340433430 |
| 11 | Fan Drive Variable Speed | 1 | 340433409 | A-340433409 |
| 12 | Main Fan | 1 | 340433410 | A-340433410 |
| 13 | - | 1 | 340433531 | A-340433531 |
| 14 | Reel Drive (1978) | 1 | 340433316 | A-340433316 |
| 14 | Reel Drive | 1 | 340433435 | A-340433435 |
| 15 | - | 1 | 340433456 | A-340433456 |
| 16 | - | 1 | 340433236 | A-340433236 |
| 17 | Rotary Filter Drive | 1 | 340433134 | A-340433134 |
| 18 | Filter | 1 | 340433162 | A-340433162 |

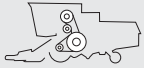
LAVERDA 3350 (EX AL 112)





| Belt No. |  | No. of Belts | OEM  Part No. | PIX  Part No. |
|----------|---|--------------|--|--|
| 1 | | 1 | 340433182 | A-340433182 |
| 2 | | 1 | 340433531 | A-340433531 |
| 3 | | 1 | 344311221 | A-344311221 |
| 4 | | 1 | 340433417 | A-340433417 |
| 5 | | 1 | 340432244 | A-340432244 |
| 6 | | 1 | 344311212 | A-344311212 |
| 7 | | 1 | 340433289 | A-340433289 |
| 8 | | 1 | 340433455 | A-340433455 |
| 9 | | 1 | 340433537 | A-340433537 |
| 10 | | 1 | 340433410 | A-340433410 |
| 11 | | 1 | 340433409 | A-340433409 |
| 12 | | 1 | 340433430 | A-340433430 |
| 13 | | 1 | 340433236 | A-340433236 |
| 14 | | 1 | 340433456 | A-340433456 |
| 15 | | 1 | 340433134 | A-340433134 |
| 16 | | 1 | 340433162 | A-340433162 |
| 17 | | 1 | 340435146 | A-340435146 |
| 18 | | 1 | 340434140 | A-340434140 |
| 19 | | 1 | 340433456 | A-340433456 |

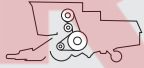

LAVERDA 3400

| Belt No. |  | No. of Belts | OEM  Part No. | PIX  Part No. |
|----------|---|--------------|--|--|
| 1 | Reverser | 1 | 340433983 | A-340433983 |
| 3 | Threshing Mechanism Drive | 1 | 344311318 | A-344311318 |
| 4 | Tank Unloading Drive | 1 | 340433465 | A-340433465 |
| 5 | Air Conditioned Cab Installation | 1 | 340433129 | A-340433129 |
| 6 | Transmission | 1 | 344311126 | A-344311126 |
| 8 | Rear Beater To Drive Transmission | 1 | 340433539 | A-340433539 |
| 9 | Drive Belts And Drive Chains (left-hand) | 2 | 340435130 | A-340435130 |
| 10 | Straw Walker Drive | 1 | 340433316 | A-340433316 |
| 11 | Auger Drives | 1 | 340433446 | A-340433446 |
| 12 | Radiator Filter Transmission | 1 | 340433181 | A-340433181 |
| 13 | Radiator Filter Transmission | 1 | 340433134 | A-340433134 |
| 14 | Drum Variator | 1 | 340435147 | A-340435147 |
| 15 | Fan Variator | 1 | 340435150 | A-340435150 |
| 16 | Fan Variator | 1 | 340435151 | A-340435151 |
| 17 | Fan Drive | 1 | 340433191 | A-340433191 |
| 18 | Secondary Cleaner Drive | 1 | 340433469 | A-340433469 |

LAVERDA 3400 R

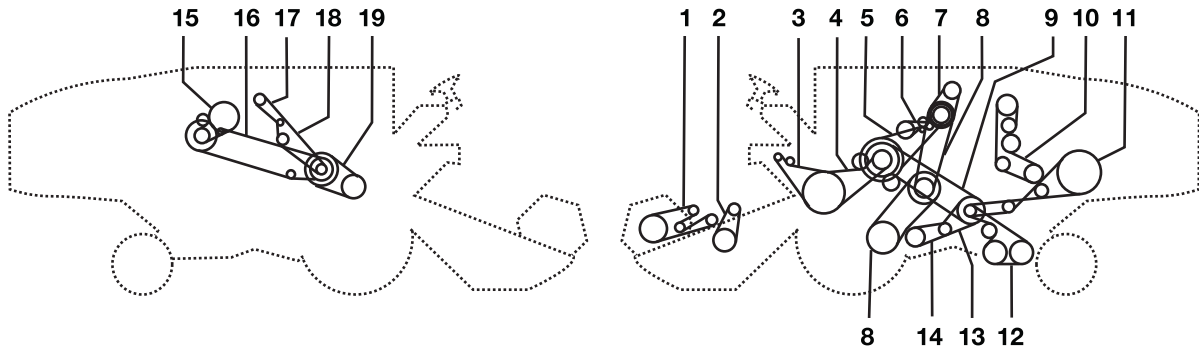

| Belt No. |  | No. of Belts | OEM  Part No. | PIX  Part No. |
|----------|---|--------------|--|--|
| 1 | Reverser | 1 | 340433983 | A-340433983 |
| 3 | Threshing Mechanism Drive | 1 | 344311318 | A-344311318 |
| 4 | Tank Unloading Drive | 1 | 340433465 | A-340433465 |
| 5 | Air Conditioned Cab Installation | 1 | 340433129 | A-340433129 |
| 6 | Transmission | 1 | 344311126 | A-344311126 |
| 8 | Rear Beater To Drive Transmission | 1 | 340433539 | A-340433539 |
| 9 | Drive Belts And Drive Chains (left-hand) | 2 | 340435130 | A-340435130 |
| 10 | Straw Walker Drive | 1 | 340433316 | A-340433316 |
| 11 | Auger Drive | 1 | 340433446 | A-340433446 |
| 12 | Radiator Filter Transmission | 1 | 340433181 | A-340433181 |
| 13 | Radiator Filter Transmission | 1 | 340433134 | A-340433134 |
| 14 | Drum Variator | 1 | 340435147 | A-340435147 |
| 15 | Fan Variator | 1 | 340435150 | A-340435150 |
| 16 | Fan Variator | 1 | 340435151 | A-340435151 |
| 17 | Fan Drive | 1 | 340433191 | A-340433191 |
| 18 | Secondary Cleaner Drive | 1 | 340433469 | A-340433469 |



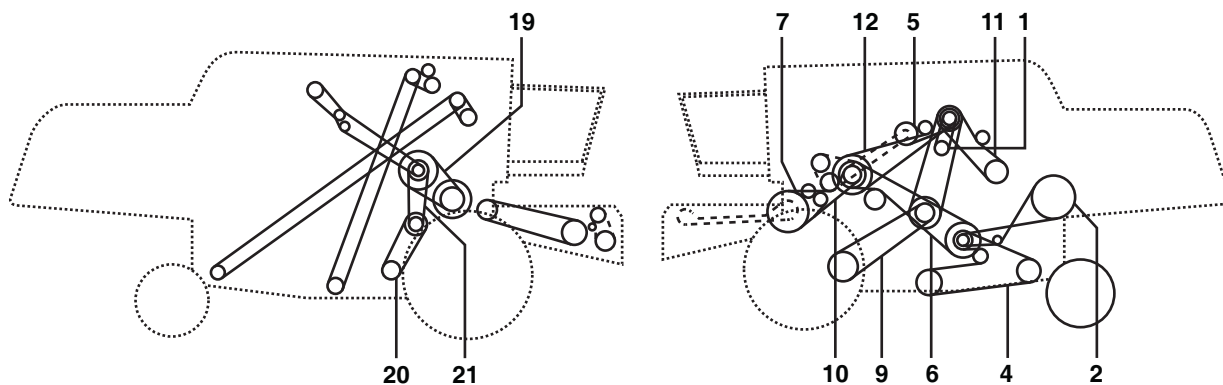

| Belt No. |  | No. of Belts | OEM  Part No. | PIX  Part No. |
|----------|---|--------------|--|--|
| 1 | Reel Drive (1978) | 1 | 340433316 | A-340433316 |
| 1 | Reel Drive | 1 | 340433435 | A-340433435 |
| 2 | Reel Drive Variable Speed | 1 | 340434138 | A-340434138 |
| 2 | Reel Drive Variable Speed | 1 | 340434140 | A-340434140 |
| 3 | Blower Drive | 1 | 340433182 | A-340433182 |
| 4 | - | 1 | 340433531 | A-340433531 |
| 5 | Threshing Drum Variator Drive | 1 | 344311221 | A-344311221 |
| 5 | Threshing Drive (1978) | 1 | 344311316 | A-344311316 |
| 6 | Auger Drive | 1 | 340433417 | A-340433417 |
| 7 | Hydraulic Pump Drive | 1 | 340432243 | A-340432243 |
| 7 | Hydraulic Pump Drive | 1 | 340432244 | A-340432244 |
| 8 | Traction Vari Drive | 2 | 340435127 | A-340435127 |
| 9 | Main Return Drive | 1 | 340433537 | A-340433537 |
| 10 | Fan Drive | 1 | 340433289 | A-340433289 |
| 11 | Straw Walker Drive | 1 | 340433455 | A-340433455 |
| 12 | Auger Drive Tailings And Grain | 1 | 340433430 | A-340433430 |
| 13 | Main Fan (primary) | 1 | 340433409 | A-340433409 |
| 14 | Main Fan (secondary) | 1 | 340433410 | A-340433410 |
| 14 | Converter Drive | 1 | 340433418 | A-340433418 |
| 15 | Feeder Shaft | 1 | 340433236 | A-340433236 |
| 16 | - | 1 | 340433456 | A-340433456 |
| 17 | Rotary Filter (secondary) | 1 | 340433134 | A-340433134 |
| 18 | Rotary Filter (primary) | 1 | 340433162 | A-340433162 |
| 19 | Cylinder Drive | 1 | 344351146 | A-344351146 |

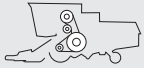
LAVERDA 3500 - 3500R - 3550 - 3550R



| Belt No. |  | No. of Belts | OEM  Part No. | PIX  Part No. |
|----------|---|--------------|--|--|
| 1 | Compressor | 2 | 340433129 | A-340433129 |
| 2 | Straw Walker Drive | 1 | 340433316 | A-340433316 |
| 3 | Fan Drive | 1 | 340433422 | A-340433422 |
| 4 | Grain Tailings Auger | 1 | 340433446 | A-340433446 |
| 5 | Auger Drive | 1 | 340433465 | A-340433465 |
| 6 | Return Drive | 1 | 340433539 | A-340433539 |
| 7 | Return Elevator | 1 | 340433983 | A-340433983 |
| 8 | Reel Variator Drive | 1 | 340434138 | A-340434138 |
| 9 | Traction Vari-drive (mechanic) | 2 | 340435130 | A-340435130 |
| 10 | Front Elevator | 1 | 344311126 | A-344311126 |
| 12 | - | 1 | 344311318 | A-344311318 |
| 13 | Alternator | 2 | 4796327 | A-4796327 |
| 16 | Rotary Screen Drive | 1 | 340433181 | A-340433181 |
| 17 | Rotary Screen Drive | 1 | 340433182 | A-340433182 |
| 19 | Drum Variator Drive | 1 | 340435147 | A-340435147 |
| 20 | Fan | 2 | 340435150 | A-340435150 |
| 21 | Return Fan | 1 | 340435151 | A-340435151 |



LAVERDA 3550 AL

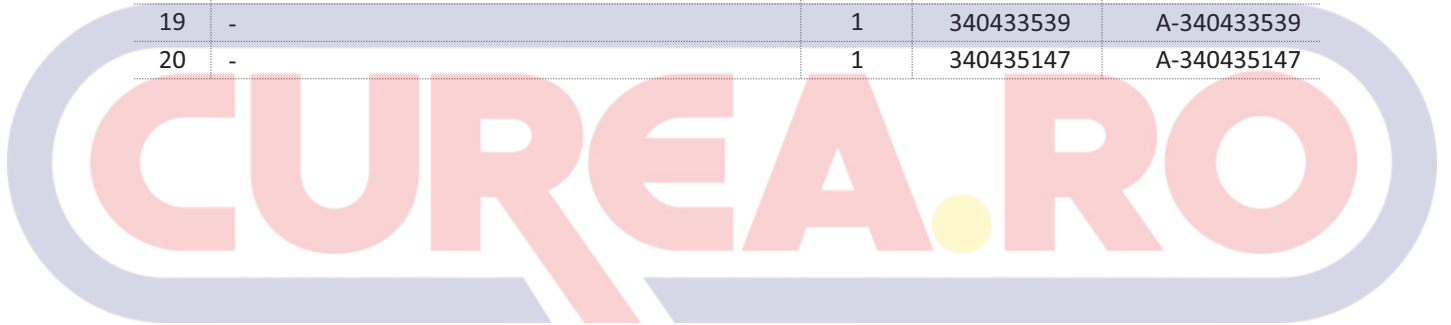

| Belt No. |  | No. of Belts | OEM  Part No. | PIX  Part No. |
|----------|---|--------------|--|--|
| 1 | - | 1 | 340434138 | A-340434138 |
| 2 | - | 1 | 340433129 | A-340433129 |
| 3 | - | 1 | 340433134 | A-340433134 |
| 4 | - | 1 | 340433181 | A-340433181 |
| 5 | - | 1 | 340433191 | A-340433191 |
| 6 | - | 1 | 340433250 | A-340433250 |
| 7 | - | 1 | 340433983 | A-340433983 |
| 8 | - | 1 | 340433316 | A-340433316 |
| 9 | - | 1 | 344311126 | A-344311126 |
| 10 | - | 1 | 344311226 | A-344311226 |
| 11 | - | 1 | 344311318 | A-344311318 |
| 12 | - | 1 | 340433465 | A-340433465 |
| 13 | - | 1 | 340433418 | A-340433418 |
| 14 | - | 1 | 340433469 | A-340433469 |
| 15 | Straw Chopper Drive | 1 | 340433472 | A-340433472 |
| 16 | - | 1 | 340433446 | A-340433446 |
| 17 | Straw Chopper Drive | 1 | 340433473 | A-340433473 |
| 19 | - | 1 | 340433539 | A-340433539 |
| 20 | - | 1 | 340435147 | A-340435147 |

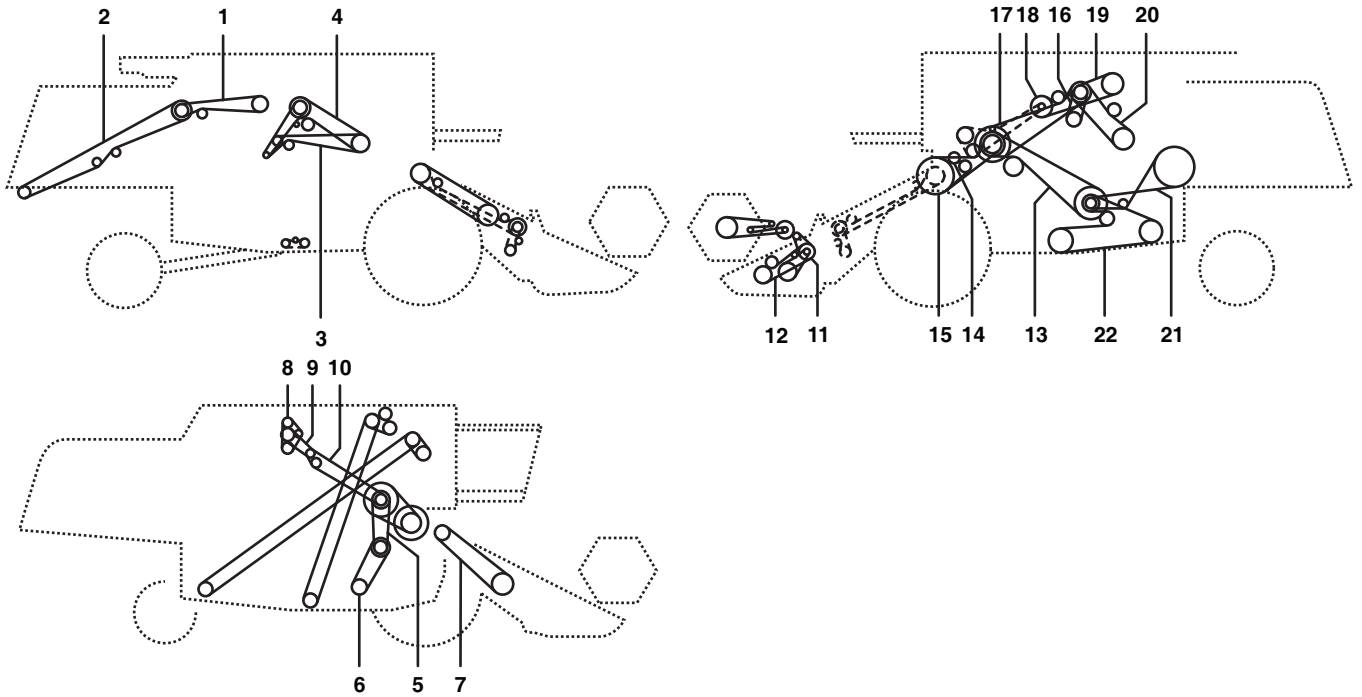

LAVERDA 3560 AL



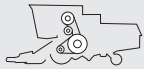



| Belt No. | | No. of Belts | OEM  Part No. | PIX  Part No. |
|----------|---|--------------|--|--|
| 1 | - | 1 | 344311129 | A-344311129 |
| 2 | - | 1 | 344311139 | A-344311139 |
| 3 | - | 1 | 340433191 | A-340433191 |
| 4 | - | 1 | 340433469 | A-340433469 |
| 5 | - | 1 | 340435151 | A-340435151 |
| 6 | - | 1 | 340435150 | A-340435150 |
| 7 | - | 1 | 340435147 | A-340435147 |
| 8 | - | 1 | 4796328 | A-4796328 |
| 9 | - | 1 | 340433134 | A-340433134 |
| 10 | - | 1 | 340433181 | A-340433181 |
| 11 | - | 1 | 340434138 | A-340434138 |
| 12 | - | 1 | 340433422 | A-340433422 |
| 13 | - | 1 | 340433539 | A-340433539 |
| 14 | - | 1 | 340433983 | A-340433983 |
| 15 | - | 1 | 344311126 | A-344311126 |
| 16 | - | 1 | 340433129 | A-340433129 |
| 17 | - | 1 | 344311318 | A-344311318 |
| 18 | - | 1 | 340433465 | A-340433465 |
| 19 | - | 1 | 340433250 | A-340433250 |
| 20 | - | 1 | 344311226 | A-344311226 |
| 21 | - | 1 | 340433316 | A-340433316 |
| 22 | - | 1 | 340433446 | A-340433446 |

| Belt No. |  | No. of Belts | OEM  Part No. | PIX  Part No. |
|----------|---|--------------|--|--|
| 1 | - | 1 | 344311127 | A-344311127 |
| 3 | Main Fan | 1 | 340433424 | A-340433424 |
| 4 | Auger Drive Tailings And Grain | 1 | 344311134 | A-344311134 |
| 5 | Straw Walker Drive | 1 | 340433458 | A-340433458 |
| 6 | Hydraulic Pump Drive | 1 | 344311217 | A-344311217 |
| 7 | Oil Pump Drive | 1 | 340432243 | A-340432243 |
| 8 | Compressor Drive | 1 | 340433129 | A-340433129 |
| 9 | Auger Drive | 1 | 340433467 | A-340433467 |
| 11 | Cylinder Variator Drive | 1 | 344311318 | A-344311318 |
| 12 | Reel Drive Variable Speed | 1 | 340434138 | A-340434138 |
| 13 | Converter Drive | 1 | 340433418 | A-340433418 |
| 14 | Rotary Filter (secondary) | 1 | 340433138 | A-340433138 |
| 15 | Rotary Filter (primary) | 1 | 340433189 | A-340433189 |
| 16 | Cylinder Drive | 1 | 340435152 | A-340435152 |

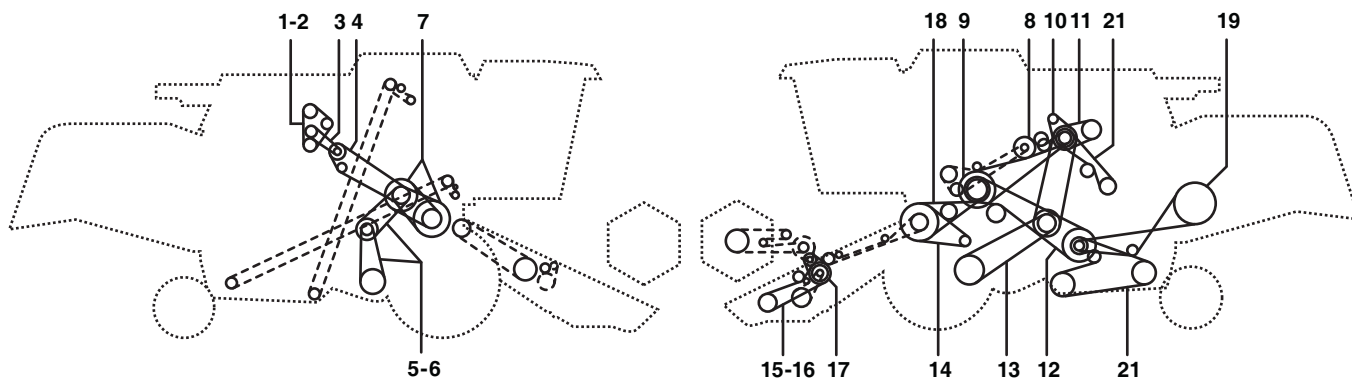



LAVERDA 3650



| Belt No. |  | No. of Belts | OEM  Part No. | PIX  Part No. |
|----------|---|--------------|--|--|
| 1 | Alternator Drive | 1 | 4796327 | A-4796327 |
| 3 | Rotary Screen Drive | 1 | 340433138 | A-340433138 |
| 4 | Rotary Screen Drive | 1 | 340433190 | A-340433190 |
| 5 | Return Fan | 1 | 340433424 | A-340433424 |
| 6 | Return Fan | 1 | 340435150 | A-340435150 |
| 7 | Drum Vari - Drive | - | 340435152 | A-340435152 |
| 8 | - | 1 | 340433475 | A-340433475 |
| 9 | - | 1 | 344311318 | A-344311318 |
| 10 | Compressor | 1 | 340433129 | A-340433129 |
| 11 | Hydraulic Pump Drive | 1 | 340433250 | A-340433250 |
| 12 | Return Drive | 1 | 340433539 | A-340433539 |
| 13 | Traction Vari - Drive | 2 | 340435131 | A-340435131 |
| 14 | - | 1 | 340433984 | A-340433984 |
| 15 | Converter Drive | 1 | 340433418 | A-340433418 |
| 16 | Fan Drive | 1 | 340433422 | A-340433422 |
| 17 | Reel - Vari Drive | 1 | 340434138 | A-340434138 |
| 18 | Front Elevator | 1 | 344311127 | A-344311127 |
| 19 | Straw Walker Drive | 1 | 340433457 | A-340433457 |
| 20 | Grain Tailings Auger | 1 | 344311134 | A-344311134 |
| 21 | - | 1 | 344311226 | A-344311226 |

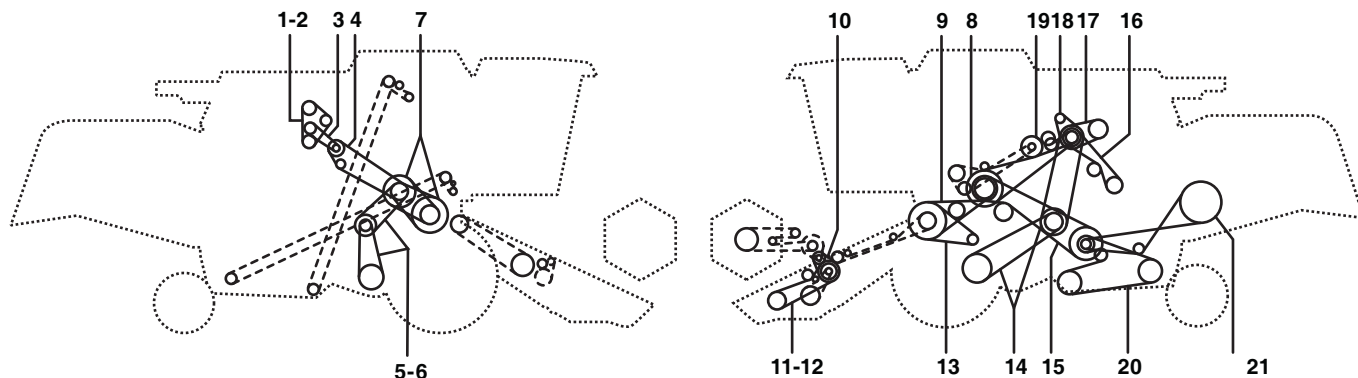

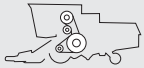
LAVERDA 3650 R



| Belt No. |  | No. of Belts | OEM  Part No. | PIX  Part No. |
|----------|---|--------------|--|--|
| 1 | | 1 | 4796327 | A-4796327 |
| 3 | | 1 | 340433138 | A-340433138 |
| 4 | | 1 | 340433190 | A-340433190 |
| 5 | | 1 | 340433424 | A-340433424 |
| 6 | | 1 | 340435150 | A-340435150 |
| 7 | | 1 | 340435152 | A-340435152 |
| 8 | | 1 | 344311318 | A-344311318 |
| 9 | | 1 | 344311127 | A-344311127 |
| 11 | | 1 | 340433418 | A-340433418 |
| 12 | | 1 | 340433422 | A-340433422 |
| 13 | | 1 | 340433984 | A-340433984 |
| 14 | | 2 | 340435131 | A-340435131 |
| 15 | | 1 | 340433539 | A-340433539 |
| 16 | | 1 | 344311226 | A-344311226 |
| 17 | | 1 | 340433250 | A-340433250 |
| 18 | | 1 | 340433129 | A-340433129 |
| 19 | | 1 | 340433475 | A-340433475 |
| 20 | | 1 | 344311134 | A-344311134 |
| 21 | | 1 | 340433457 | A-340433457 |

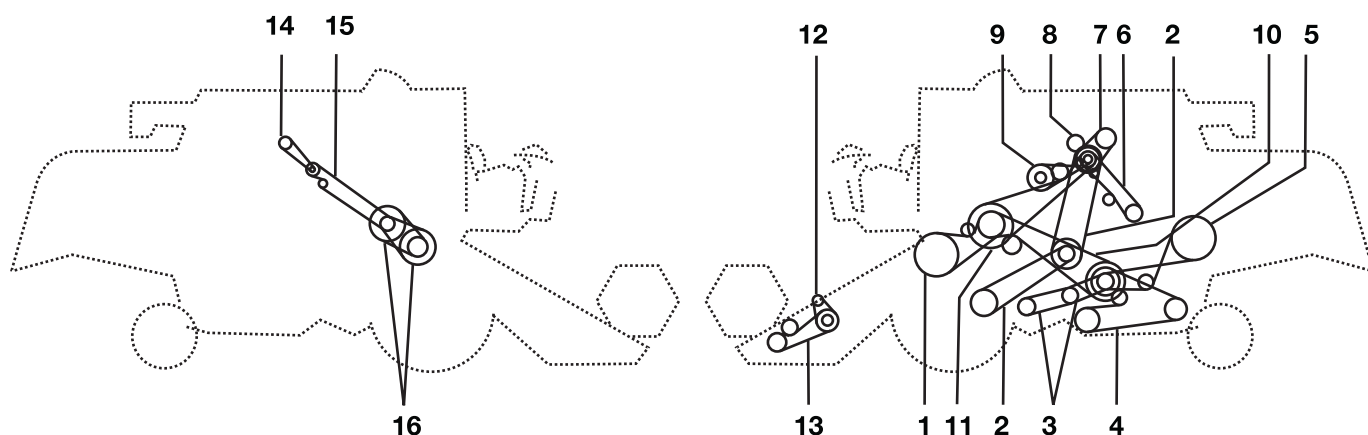

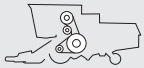
LAVERDA 3700



| Belt No. |  | No. of Belts | OEM  Part No. | PIX  Part No. |
|----------|---|--------------|--|--|
| 1 | - | 1 | 344311127 | A-344311127 |
| 3 | Main Fan | 1 | 340433424 | A-340433424 |
| 4 | Auger Drive Tailings Andgrain | 1 | 344311134 | A-344311134 |
| 5 | Straw Walker Drive | 1 | 340433458 | A-340433458 |
| 7 | Oil Pump Drive | 1 | 340432243 | A-340432243 |
| 8 | Compressor Drive | 1 | 340433129 | A-340433129 |
| 9 | Auger Drive | 1 | 340433467 | A-340433467 |
| 11 | Cylinder Variatordrive | 1 | 344311318 | A-344311318 |
| 12 | Reel Drive Variable Speed | 1 | 340434138 | A-340434138 |
| 13 | Converter Drive | 1 | 340433418 | A-340433418 |
| 14 | Rotary Filter (secondary) | 1 | 340433144 | A-340433144 |
| 15 | Rotary Filter (primary) | 1 | 340433184 | A-340433184 |

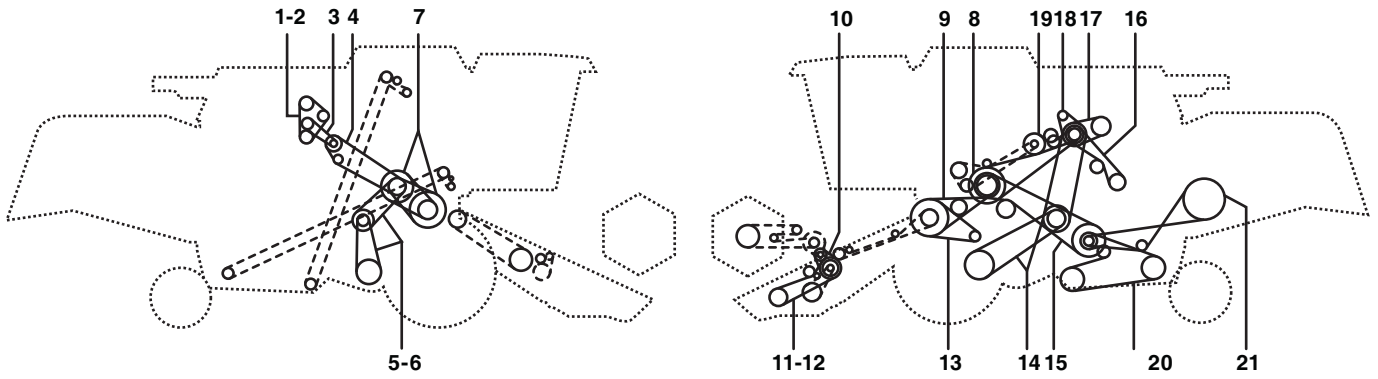

LAVERDA 3750



| Belt No. |  | No. of Belts | OEM  Part No. | PIX  Part No. |
|----------|---|--------------|--|--|
| 1 | Alternator | 1 | 4796327 | A-4796327 |
| 3 | Rotary Screen Drive | 1 | 340433138 | A-340433138 |
| 4 | Rotary Screen Drive | 1 | 340433190 | A-340433190 |
| 5 | Return Fan | 1 | 340433424 | A-340433424 |
| 6 | Fan | 1 | 340435150 | A-340435150 |
| 7 | Drum Vari - Drive | 1 | 340435152 | A-340435152 |
| 8 | - | 1 | 344311318 | A-344311318 |
| 9 | Front Elevator | 1 | 344311127 | A-344311127 |
| 11 | Converter Drive | 1 | 340433418 | A-340433418 |
| 12 | Fan Drive | 1 | 340433422 | A-340433422 |
| 13 | - | 1 | 340433984 | A-340433984 |
| 14 | Traction Vari - Drive | 2 | 340435131 | A-340435131 |
| 15 | Return Drive | 1 | 340433539 | A-340433539 |
| 16 | - | 1 | 344311226 | A-344311226 |
| 17 | - | 1 | 340433250 | A-340433250 |
| 18 | Compressor | 1 | 340433129 | A-340433129 |
| 19 | - | 1 | 340433475 | A-340433475 |
| 20 | Grain Tailings Auger | 1 | 344311134 | A-344311134 |
| 21 | Straw Walker Drive | 1 | 340433457 | A-340433457 |

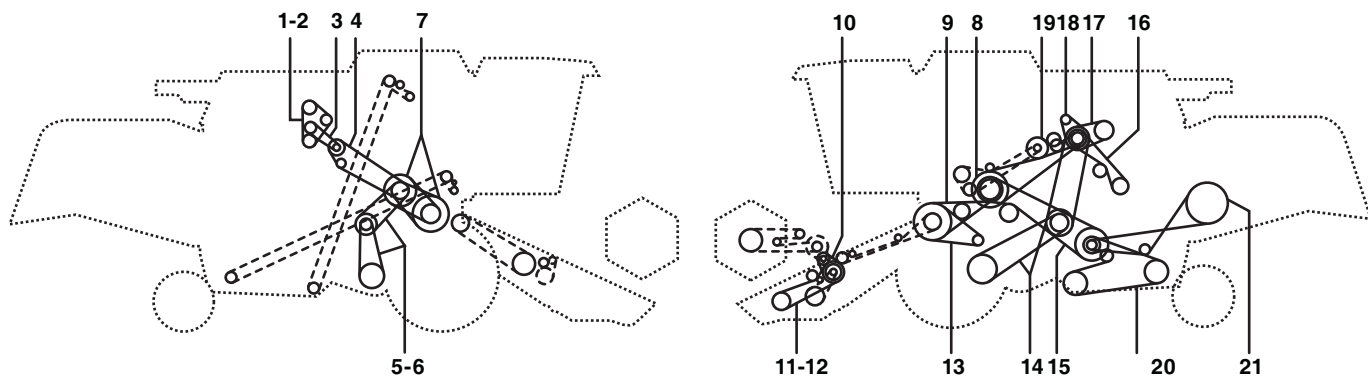

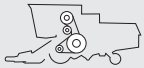
LAVERDA 3750 R



| Belt No. |  | No. of Belts | OEM  Part No. | PIX  Part No. |
|----------|---|--------------|--|--|
| 1 | Alternator | 1 | 4796327 | A-4796327 |
| 3 | Rotary Screen Drive | 1 | 340433138 | A-340433138 |
| 4 | Rotary Screen Drive | 1 | 340433190 | A-340433190 |
| 5 | Return Fan | 1 | 340433424 | A-340433424 |
| 6 | Fan | 1 | 340435150 | A-340435150 |
| 7 | Drum Vari - Drive | 1 | 340435152 | A-340435152 |
| 8 | - | 1 | 344311318 | A-344311318 |
| 9 | Front Elevator | 1 | 344311127 | A-344311127 |
| 11 | Converter Drive | 1 | 340433418 | A-340433418 |
| 12 | Fan Drive | 1 | 340433422 | A-340433422 |
| 13 | - | 1 | 340433984 | A-340433984 |
| 14 | Traction Vari - Drive | 2 | 340435131 | A-340435131 |
| 15 | Return Drive | 1 | 340433539 | A-340433539 |
| 16 | - | 1 | 344311226 | A-344311226 |
| 17 | - | 1 | 340433250 | A-340433250 |
| 18 | Compressor | 1 | 340433129 | A-340433129 |
| 19 | - | 1 | 340433475 | A-340433475 |
| 20 | Grain Tailings Auger | 1 | 344311134 | A-344311134 |
| 21 | Straw Walker Drive | 1 | 340433457 | A-340433457 |

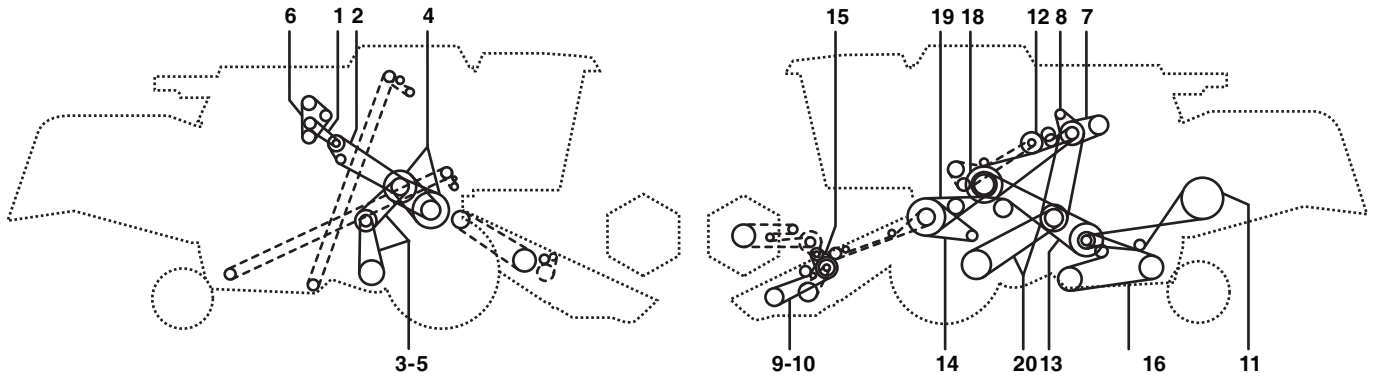

LAVERDA 3850



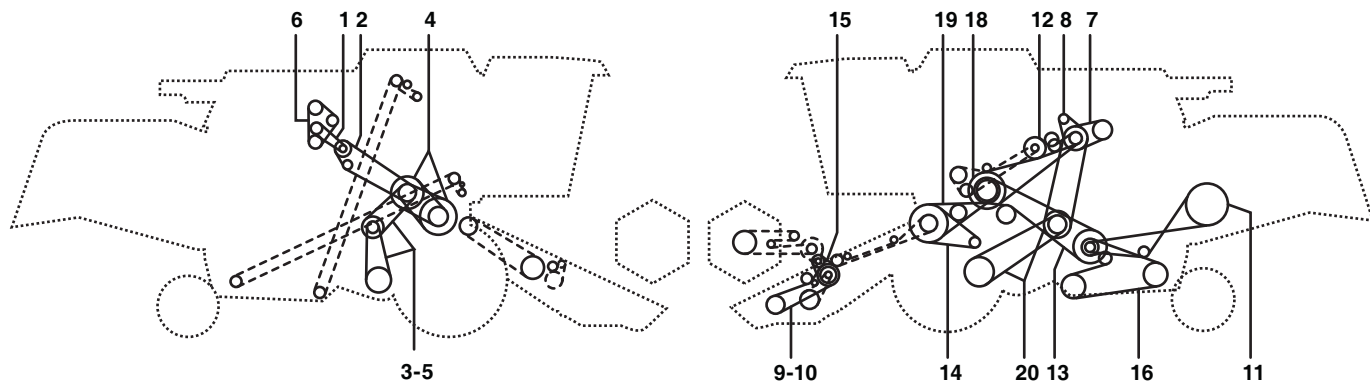

| Belt No. |  | No. of Belts | OEM  Part No. | PIX  Part No. |
|----------|---|--------------|--|--|
| 1 | Rotary Screen Drive | 1 | 340433138 | A-340433138 |
| 2 | Rotary Screen Drive | 1 | 340433190 | A-340433190 |
| 3 | Return Fan | 1 | 340433424 | A-340433424 |
| 4 | Drum Vari - Drive | 2 | 340435124 | A-340435124 |
| 5 | Fan | 1 | 340435150 | A-340435150 |
| 7 | Hydrostatic Drive | 1 | 340432246 | A-340432246 |
| 8 | Compressor | 1 | 340433129 | A-340433129 |
| 9 | Converter Drive | 1 | 340433418 | A-340433418 |
| 10 | Fan Drive | 1 | 340433422 | A-340433422 |
| 11 | Straw Walker Drive | 1 | 340433457 | A-340433457 |
| 12 | Auger Drive | 1 | 340433467 | A-340433467 |
| 13 | Return Drive | 1 | 340433539 | A-340433539 |
| 14 | Return Elevator | 1 | 340433983 | A-340433983 |
| 15 | Reel Vari - Drive | 1 | 340434138 | A-340434138 |
| 16 | Grain Tailings Auger | 1 | 344311134 | A-344311134 |
| 17 | - | 1 | 344311226 | A-344311226 |
| 18 | - | 1 | 344311318 | A-344311318 |
| 19 | Straw Elevator Drive | 1 | 344312127 | A-344312127 |
| 20 | - | 2 | 340435131 | A-340435131 |

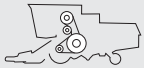
LAVERDA 3850 R







| Belt No. |  | No. of Belts | OEM  Part No. | PIX  Part No. |
|----------|---|--------------|--|--|
| 1 | Rotary Screen Drive | 1 | 340433138 | A-340433138 |
| 2 | Rotary Screen Drive | 1 | 340433190 | A-340433190 |
| 3 | Return Fan | 1 | 340433424 | A-340433424 |
| 4 | Drum Vari - Drive | 2 | 340435124 | A-340435124 |
| 5 | Fan | 1 | 340435150 | A-340435150 |
| 7 | Hydrostatic Drive | 1 | 340432246 | A-340432246 |
| 8 | Compressor | 1 | 340433129 | A-340433129 |
| 9 | Converter Drive | 1 | 340433418 | A-340433418 |
| 10 | Fan Drive | 1 | 340433422 | A-340433422 |
| 11 | Straw Walker Drive | 1 | 340433457 | A-340433457 |
| 12 | Auger Drive | 1 | 340433467 | A-340433467 |
| 13 | Return Drive | 1 | 340433539 | A-340433539 |
| 14 | Return Elevator | 1 | 340433983 | A-340433983 |
| 15 | Reel Vari - Drive | 1 | 340434138 | A-340434138 |
| 16 | Grain Tailings Auger | 1 | 344311134 | A-344311134 |
| 17 | - | 1 | 344311226 | A-344311226 |
| 18 | - | 1 | 344311318 | A-344311318 |
| 19 | Straw Elevator Drive | 1 | 344312127 | A-344312127 |
| 20 | - | 2 | 340435131 | A-340435131 |

| Belt No. |  | No. of Belts | OEM  Part No. | PIX  Part No. |
|----------|---|--------------|--|--|
| 1 | REEL DRIVE VARIABLE SPEED | 1 | 340434138 | A-340434138 |
| 2 | COMPRESSOR DRIVE | 1 | 340433129 | A-340433129 |
| 4 | ROTARY FILTER (PRIMARY) | 1 | 340433190 | A-340433190 |
| 5 | OIL PUMP DRIVE | 1 | 340432246 | A-340432246 |
| 6 | - | 1 | 340433983 | A-340433983 |
| 7 | AUGER DRIVE TAILINGS ANDGRAIN | 1 | 344311134 | A-344311134 |
| 8 | STRAW CHOPPER DRIVE | 1 | 344311137 | A-344311137 |
| 9 | HYDRAULIC PUMP DRIVE | 1 | 344311226 | A-344311226 |
| 10 | CYLINDER VARIATOR DRIVE | 1 | 344311318 | A-344311318 |
| 11 | ENGINE FAN DRIVE | 1 | 340433243 | A-340433243 |
| 12 | AUGER DRIVE | 1 | 340433467 | A-340433467 |
| 13 | CONVERTER (C) | 1 | 340433418 | A-340433418 |
| 14 | CONVERTER (E) | 1 | 340433422 | A-340433422 |
| 15 | STRAW WALKER DRIVE | 1 | 340433457 | A-340433457 |
| 16 | STRAW ELEVATOR DRIVE | 1 | 344312127 | A-344312127 |
| 17 | RETURN DRIVE | 1 | 340433539 | A-340433539 |
| 18 | MAIN FAN | 1 | 340435150 | A-340435150 |

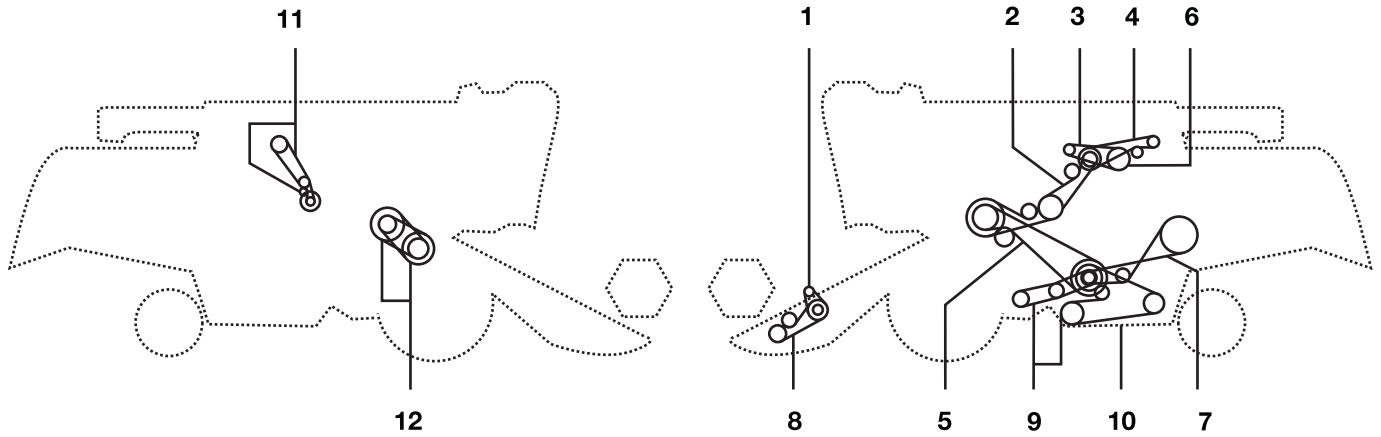



LAVERDA 3900



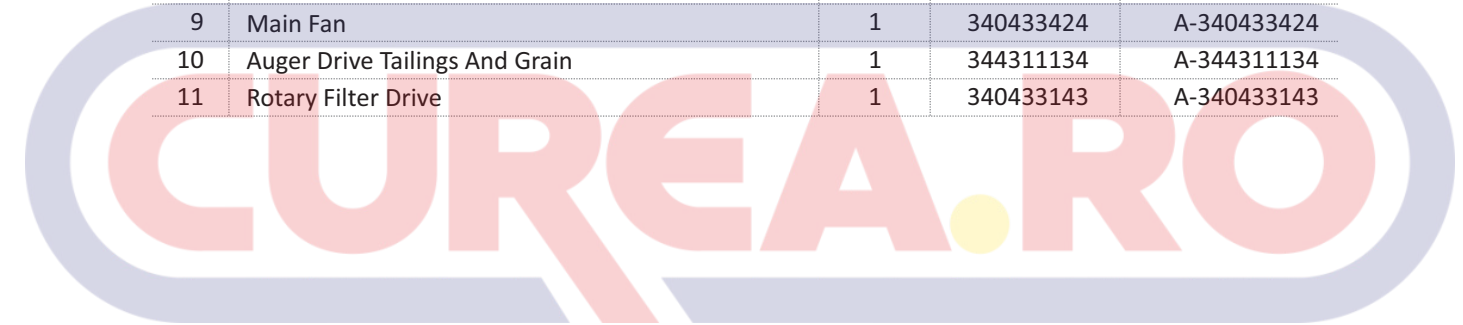

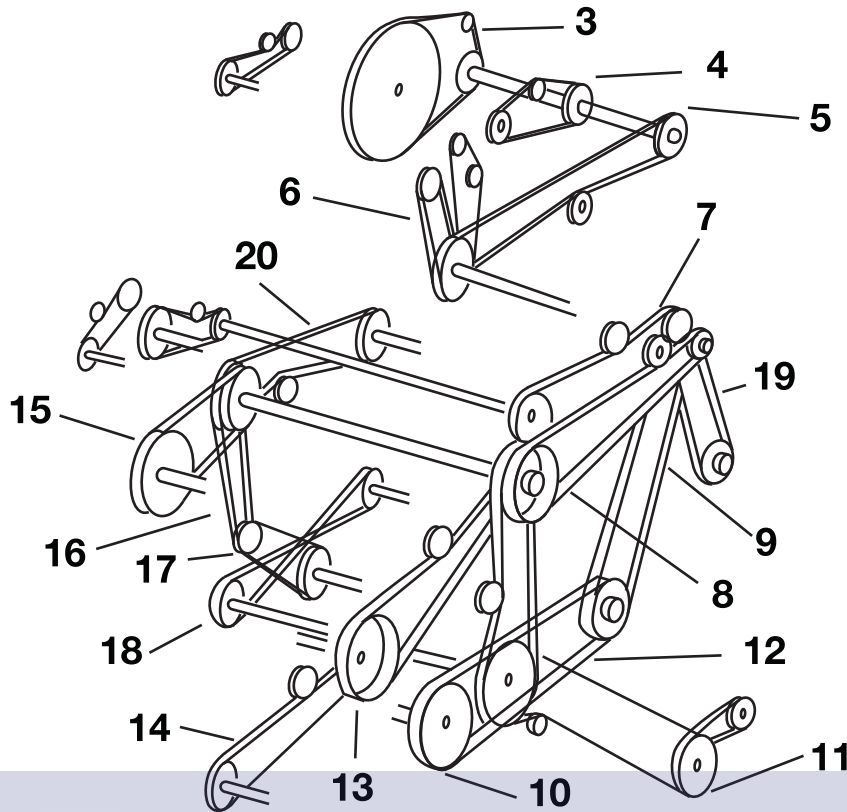
| Belt No. |  | No. of Belts | OEM  Part No. | PIX  Part No. |
|----------|---|--------------|--|--|
| 1 | | 1 | 340434138 | A-340434138 |
| 2 | | 1 | 344311418 | A-344311418 |
| 4 | | 1 | 344311314 | A-344311314 |
| 6 | | 1 | 340433256 | A-340433256 |
| 7 | | 1 | 340433457 | A-340433457 |
| 8 | | 1 | 340433418 | A-340433418 |
| 9 | | 1 | 340433424 | A-340433424 |
| 10 | | 1 | 344311134 | A-344311134 |
| 11 | | 1 | 340433143 | A-340433143 |

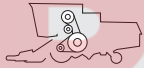





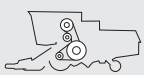

| Belt No. |  | No. of Belts | OEM  Part No. | PIX  Part No. |
|----------|---|--------------|--|--|
| 0 | Water Pump - Alternator - Eng. (wo Air Co) | 1 | 84005860 | A-84005860 |
| 3 | Rotary Dust Screen | 1 | 89514310 | A-89514310 |
| 4 | Radiator Fan (for L411 Only) | 1 | 89831515 | A-89831515 |
| 4 | Radiator Fan (for L413-L416-L516) | 1 | 89818704 | A-89818704 |
| 5 | Engine | 1 | 89818705 | A-89818705 |
| 7 | Intermediate Shaft - Engine | 1 | 89838606 | A-89838606 |
| 8 | Beatershaft - Main Drive | 1 | 89817374 | A-89817374 |
| 11 | Grain Auger | 1 | 80422731 | A-80422731 |
| 12 | Beater Shaft - Eccentric Shaft | 1 | 80387469 | A-80387469 |
| 13 | Straw Elevator - Beater Shaft | 2 | 80066232 | A-80066232 |
| 13 | Straw Elevator - Beater Shaft | 1 | 80424563 | A-80424563 |
| 14 | Header Driver | 1 | 89835120 | A-89835120 |
| 14 | Header Driver | 1 | 89839375 | A-89839375 |
| 15 | Drum - Beater Shaft | 1 | 80336784 | A-80336784 |
| 16 | Beater Shaft | 1 | 89515075 | A-89515075 |
| 17 | Fan | 1 | 89515076 | A-89515076 |
| 18 | Straw Walkers - Eccentric Shaft | 1 | 80431784 | A-80431784 |
| 19 | Hydrostatic Pump | 1 | 89818873 | A-89818873 |
| 20 | Rotary Separator | 1 | 89837412 | A-89837412 |

L AVERDA L 517

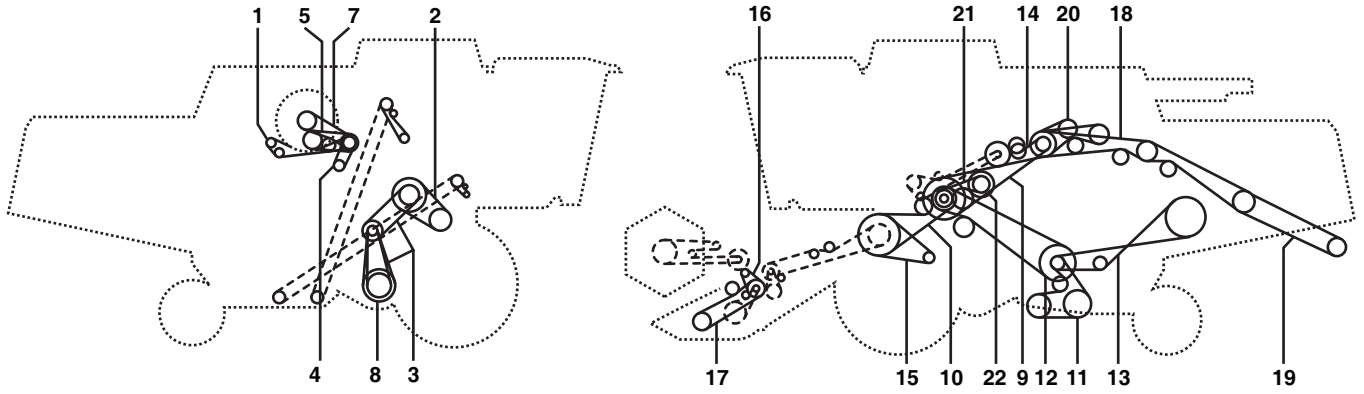
| Belt No. |  | No. of Belts | OEM  Part No. | PIX  Part No. |
|----------|---|--------------|--|--|
| 1 | Post Cylinder Variator Drive | 1 | 344311318 | A-344311318 |
| 2 | Straw Elevator Drive | 1 | 344311127 | A-344311127 |
| 2 | Straw Elevator Drive | 1 | 344312128 | A-344312128 |
| 3 | Auger Drive Tailings And Grain | 1 | 344311123 | A-344311123 |
| 4 | Fan Return Drive | 1 | 340433539 | A-340433539 |
| 5 | Straw Elevator Drive | 1 | 340433474 | A-340433474 |
| 6 | Discharge Drive Grain Tank | 1 | 340433475 | A-340433475 |
| 7 | Rotary Filter Drive | 1 | 340433181 | A-340433181 |
| 8 | Cylinder Variator Drive | 1 | 340435152 | A-340435152 |
| 9 | Fan Drive | 1 | 340435150 | A-340435150 |
| 11 | Central Return Drive | 1 | 340433984 | A-340433984 |
| 12 | Reel Drive Variable Speed | 1 | 340434138 | A-340434138 |
| 13 | - | 1 | 340433422 | A-340433422 |
| 14 | Compressor Drive | 1 | 340433131 | A-340433131 |
| 16 | - | 1 | 340433260 | A-340433260 |
| 17 | - | 1 | 340433270 | A-340433270 |
| 18 | Chopper Drive | 1 | 344311130 | A-344311130 |
| 19 | Chopper Drive | 1 | 344311151 | A-344311151 |
| 21 | - | 1 | 344311228 | A-344311228 |
| 36 | Fan Drive | 1 | 340433159 | A-340433159 |
| 38 | Fan Drive | 1 | 340435153 | A-340435153 |



LAVERDA L 518



| Belt No. |  | No. of Belts | OEM  Part No. | PIX  Part No. |
|----------|---|--------------|--|--|
| 1 | - | 1 | 340433179 | A-340433179 |
| 2 | - | 1 | 340435152 | A-340435152 |
| 3 | - | 2 | 340435150 | A-340435150 |
| 4 | Drive Variator Frame | 1 | 340433132 | A-340433132 |
| 5 | - | 1 | 340433260 | A-340433260 |
| 6 | - | 1 | 340433270 | A-340433270 |
| 7 | - | 1 | 340433268 | A-340433268 |
| 8 | Fan Drive | 1 | 340435153 | A-340435153 |
| 9 | Post Cylinder Variator Drive | 1 | 344311318 | A-344311318 |
| 10 | Straw Elevator Drive | 1 | 344312128 | A-344312128 |
| 11 | Auger Drive Tailings Andgrain | 1 | 344311123 | A-344311123 |
| 12 | Fan Return Drive | 1 | 340433539 | A-340433539 |
| 13 | Straw Elevator Drive | 1 | 340433474 | A-340433474 |
| 14 | Discharge Drive Grain Tank | 1 | 340433475 | A-340433475 |
| 15 | - | 1 | 340433984 | A-340433984 |
| 16 | - | 1 | 340434138 | A-340434138 |
| 17 | - | 1 | 340433422 | A-340433422 |
| 18 | Chopper Drive | 1 | 344311130 | A-344311130 |
| 19 | Chopper Drive | 1 | 344311151 | A-344311151 |
| 20 | Pump Drive | 1 | 344311228 | A-344311228 |
| 21 | Fan Drive | 1 | 340433405 | A-340433405 |
| 22 | Fan Drive | 1 | 340433159 | A-340433159 |

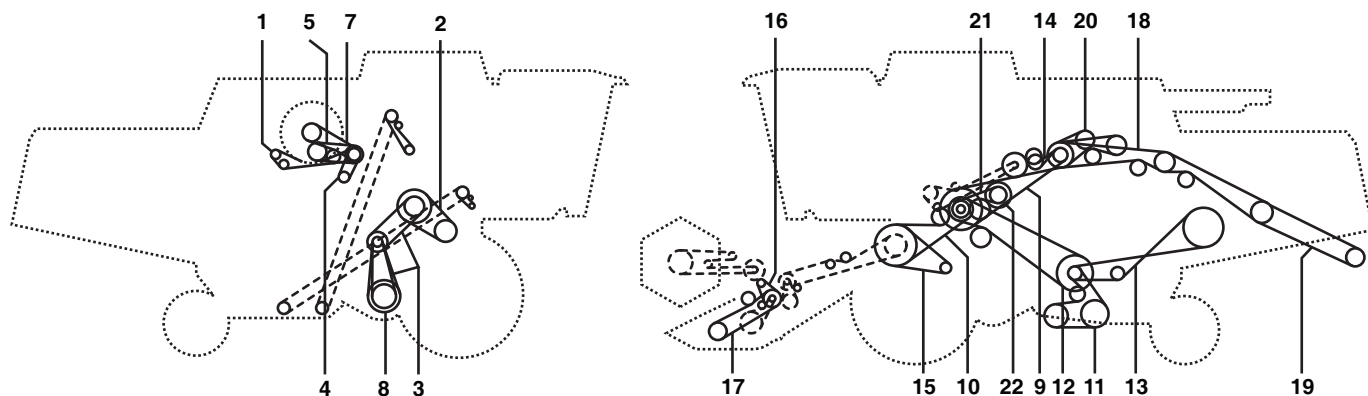

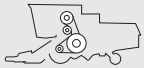
LAVERDA L 520



| Belt No. |  | No. of Belts | OEM  Part No. | PIX  Part No. |
|----------|---|--------------|--|--|
| 1 | - | 1 | 340433179 | A-340433179 |
| 2 | - | 1 | 340435152 | A-340435152 |
| 3 | - | 2 | 340435150 | A-340435150 |
| 4 | Drive Variator Frame | 1 | 340433132 | A-340433132 |
| 5 | - | 1 | 340433260 | A-340433260 |
| 6 | - | 1 | 340433270 | A-340433270 |
| 7 | - | 1 | 340433268 | A-340433268 |
| 8 | Fan Drive | 1 | 340435153 | A-340435153 |
| 9 | Post Cylinder Variator Drive | 1 | 344311318 | A-344311318 |
| 10 | Straw Elevator Drive | 1 | 344312128 | A-344312128 |
| 11 | Auger Drive Tailings And Grain | 1 | 344311123 | A-344311123 |
| 12 | Fan Return Drive | 1 | 340433539 | A-340433539 |
| 13 | Straw Elevator Drive | 1 | 340433474 | A-340433474 |
| 14 | Discharge Drive Grain Tank | 1 | 340433475 | A-340433475 |
| 15 | - | 1 | 340433984 | A-340433984 |
| 16 | - | 1 | 340434138 | A-340434138 |
| 17 | - | 1 | 340433422 | A-340433422 |
| 18 | Chopper Drive | 1 | 344311130 | A-344311130 |
| 19 | Chopper Drive | 1 | 344311151 | A-344311151 |
| 20 | Pump Drive | 1 | 344311228 | A-344311228 |
| 21 | Fan Drive | 1 | 340433405 | A-340433405 |
| 22 | Fan Drive | 1 | 340433159 | A-340433159 |

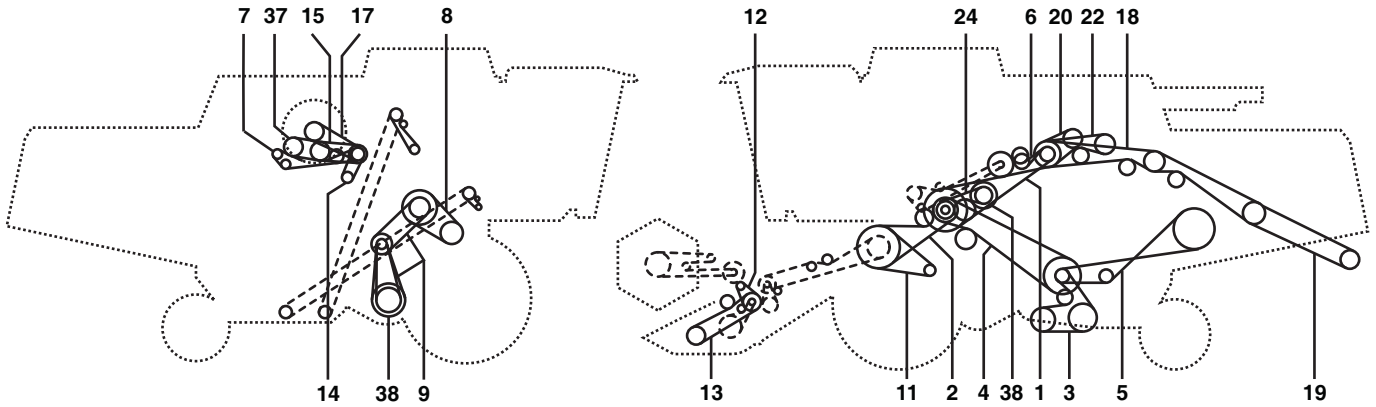

LAVERDA L 521



| Belt No. |  | No. of Belts | OEM  Part No. | PIX  Part No. |
|----------|---|--------------|--|--|
| 1 | Post Cylinder Variator Drive | 1 | 344311318 | A-344311318 |
| 2 | Straw Elevator Drive | 1 | 344311127 | A-344311127 |
| 2 | Straw Elevator Drive | 1 | 344312128 | A-344312128 |
| 3 | Auger Drive Tailings Andgrain | 1 | 344311123 | A-344311123 |
| 4 | Fan Return Drive | 1 | 340433539 | A-340433539 |
| 5 | Straw Elevator Drive | 1 | 340433474 | A-340433474 |
| 6 | Discharge Drive Grain Tank | 1 | 340433475 | A-340433475 |
| 7 | Rotary Filter | 1 | 340433984 | A-340433984 |
| 8 | Cylinder Variator drive | 1 | 340434138 | A-340434138 |
| 9 | Fan | 1 | 340433422 | A-340433422 |
| 11 | Central Return Drive | 1 | 344311130 | A-344311130 |
| 12 | Reel Drive Variable Speed | 1 | 344311151 | A-344311151 |
| 13 | - | 1 | 340433151 | A-340433151 |
| 14 | Compressor Drive | 1 | 340433253 | A-340433253 |
| 15 | - | 1 | 344311227 | A-344311227 |
| 17 | - | 1 | 340433405 | A-340433405 |
| 18 | Chopper Drive | 1 | 340433159 | A-340433159 |
| 19 | Chopper Drive | 1 | 340433181 | A-340433181 |
| 20 | Hydraulic Pump Drive | 1 | 340435152 | A-340435152 |
| 20 | Hydraulic Pump Drive | 2 | 340435150 | A-340435150 |
| 22 | Hydraulic Pump Drive | 1 | 340433131 | A-340433131 |
| 24 | Fan | 1 | 340433262 | A-340433262 |
| 36 | Fan | 1 | 340433270 | A-340433270 |
| 37 | Pump Drive | 1 | 340433152 | A-340433152 |
| 37 | Pump Drive | 1 | 340433259 | A-340433259 |
| 38 | Fan Drive | 1 | 340435153 | A-340435153 |

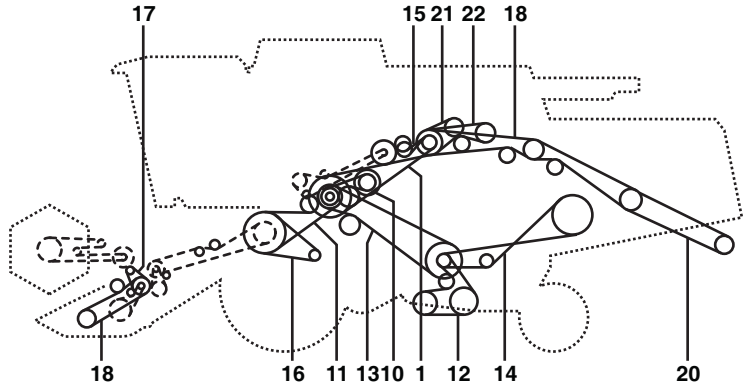
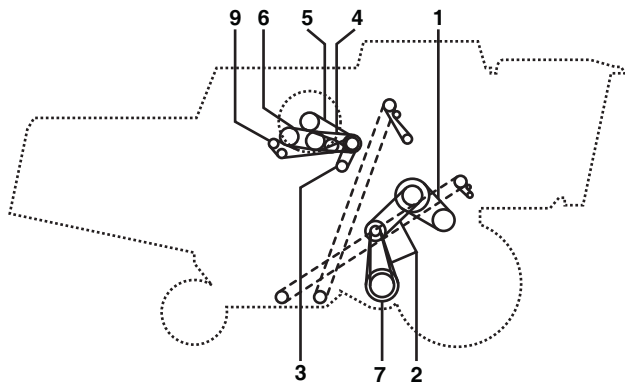

LAVERDA L 523 - INTEGRALE



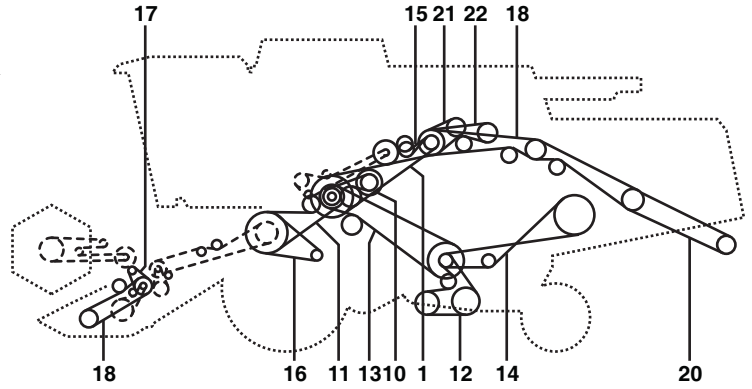
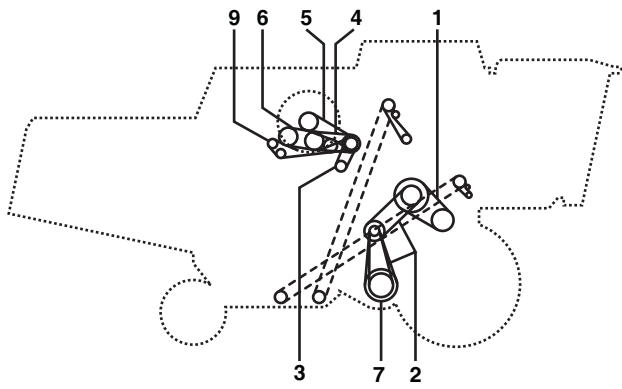

| Belt No. |  | No. of Belts | OEM  Part No. | PIX  Part No. |
|----------|---|--------------|--|--|
| 1 | Cylinder Variator Drive | 1 | 340435152 | A-340435152 |
| 2 | Fan Drive | 2 | 340435150 | A-340435150 |
| 3 | - | 1 | 340433132 | A-340433132 |
| 4 | - | 1 | 340433262 | A-340433262 |
| 5 | - | 1 | 340433270 | A-340433270 |
| 6 | Hydraulic Pump Drive | 1 | 340433259 | A-340433259 |
| 7 | Fan Drive | 1 | 340435153 | A-340435153 |
| 8 | - | 1 | 340433268 | A-340433268 |
| 9 | - | 1 | 340433179 | A-340433179 |
| 10 | Post Cylinder Variator Drive | 1 | 344311318 | A-344311318 |
| 11 | Straw Elevator Drive | 1 | 344312128 | A-344312128 |
| 12 | Auger Drive Tailings And Grain | 1 | 344311123 | A-344311123 |
| 13 | Fan Return Drive | 1 | 340433539 | A-340433539 |
| 14 | Straw Elevator Drive | 1 | 340433474 | A-340433474 |
| 15 | Discharge Drive Grain Tank | 1 | 340433475 | A-340433475 |
| 16 | Central Return Drive | 1 | 340433984 | A-340433984 |
| 17 | Reel Drive Variable Speed | 1 | 340434138 | A-340434138 |
| 18 | - | 1 | 340433422 | A-340433422 |
| 19 | Chopper Drive | 1 | 344311130 | A-344311130 |
| 20 | Chopper Drive | 1 | 344311151 | A-344311151 |
| 21 | - | 1 | 340433253 | A-340433253 |
| 22 | Hydraulic Pump Drive | 1 | 344311227 | A-344311227 |
| 23 | Fan Drive | 1 | 340433159 | A-340433159 |

LAVERDA L 523 - MCS





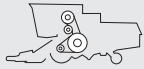

| Belt No. |  | No. of Belts | OEM  Part No. | PIX  Part No. |
|----------|---|--------------|--|--|
| 1 | Cylinder Variator drive | 1 | 340435152 | A-340435152 |
| 2 | Fan Drive | 2 | 340435150 | A-340435150 |
| 3 | - | 1 | 340433132 | A-340433132 |
| 4 | - | 1 | 340433262 | A-340433262 |
| 5 | - | 1 | 340433270 | A-340433270 |
| 6 | Hydraulic Pump Drive | 1 | 340433259 | A-340433259 |
| 7 | Fan Drive | 1 | 340435153 | A-340435153 |
| 8 | - | 1 | 340433268 | A-340433268 |
| 9 | - | 1 | 340433179 | A-340433179 |
| 10 | Post Cylinder Variator Drive | 1 | 344311318 | A-344311318 |
| 11 | Straw Elevator Drive | 1 | 344312128 | A-344312128 |
| 12 | Auger Drive Tailings And grain | 1 | 344311123 | A-344311123 |
| 13 | Fan Return Drive | 1 | 340433539 | A-340433539 |
| 14 | Straw Elevator Drive | 1 | 340433474 | A-340433474 |
| 15 | Discharge Drive Grain Tank | 1 | 340433475 | A-340433475 |
| 16 | Central Return Drive | 1 | 340433984 | A-340433984 |
| 17 | Reel Drive Variable Speed | 1 | 340434138 | A-340434138 |
| 18 | - | 1 | 340433422 | A-340433422 |
| 19 | Chopper Drive | 1 | 344311130 | A-344311130 |
| 20 | Chopper Drive | 1 | 344311151 | A-344311151 |
| 21 | - | 1 | 340433253 | A-340433253 |
| 22 | Hydraulic Pump Drive | 1 | 344311227 | A-344311227 |
| 23 | Fan Drive | 1 | 340433405 | A-340433405 |
| 24 | Fan Drive | 1 | 340433159 | A-340433159 |

LAVERDA L 524

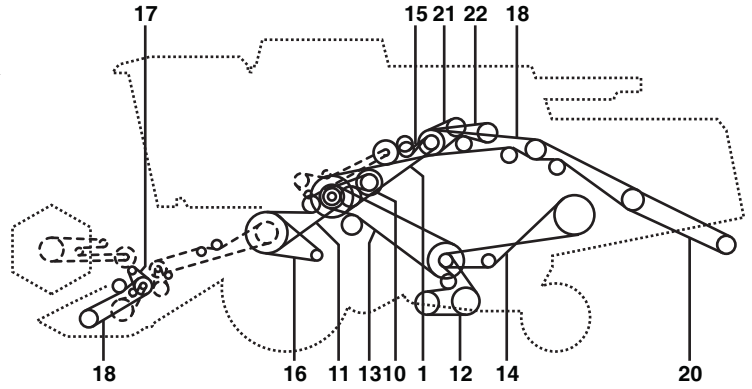
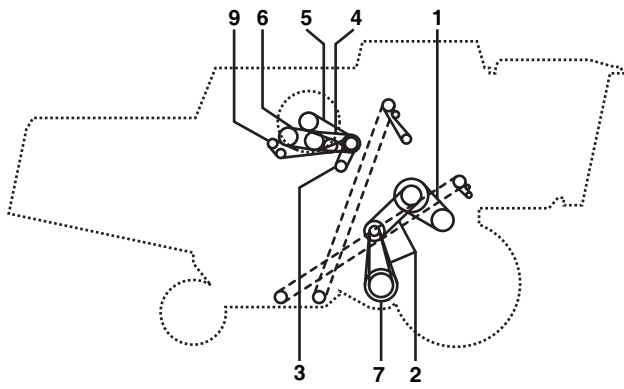
| Belt No. |  | No. of Belts | OEM  Part No. | PIX  Part No. |
|----------|---|--------------|--|--|
| 1 | Post Cylinder Variator Drive | 1 | 344311318 | A-344311318 |
| 2 | Straw Elevator Drive | 1 | 344311127 | A-344311127 |
| 2 | Straw Elevator Drive | 1 | 344312128 | A-344312128 |
| 3 | Auger Drive Tailings And Grain | 1 | 344311123 | A-344311123 |
| 4 | Fan Return Drive | 1 | 340433539 | A-340433539 |
| 5 | Straw Walker Drive | 1 | 340433474 | A-340433474 |
| 6 | Discharge Drive Grain Tank | 1 | 340433475 | A-340433475 |
| 7 | Rotary Filter Drive | 1 | 340433152 | A-340433152 |
| 8 | Cylinder Variator Drive | 1 | 340435152 | A-340435152 |
| 9 | Fan Drive | 1 | 340435150 | A-340435150 |
| 11 | Central Return Drive | 1 | 340433984 | A-340433984 |
| 12 | Reel Drive Variable Speed | 1 | 340434138 | A-340434138 |
| 13 | - | 1 | 340433422 | A-340433422 |
| 14 | Compressor Drive | 1 | 340433131 | A-340433131 |
| 15 | - | 1 | 340433262 | A-340433262 |
| 17 | - | 1 | 340433270 | A-340433270 |
| 18 | Chopper Drive | 1 | 344311130 | A-344311130 |
| 19 | Chopper Drive | 1 | 344311151 | A-344311151 |
| 20 | - | 1 | 340433151 | A-340433151 |
| 20 | - | 1 | 340433253 | A-340433253 |
| 22 | Hydraulic Pump Drive | 1 | 344311227 | A-344311227 |
| 36 | Fan Drive | 1 | 340433159 | A-340433159 |
| 37 | Hydraulic Pump Drive | 1 | 340433259 | A-340433259 |
| 38 | Fan Drive | 1 | 340435153 | A-340435153 |



LAVERDA L 525 - INTEGRALE



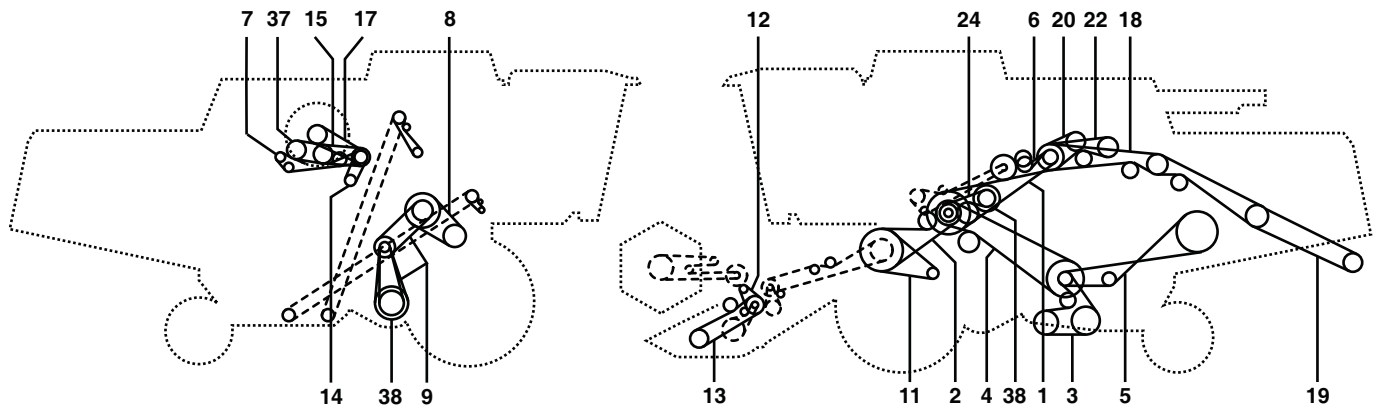

| Belt No. |  | No. of Belts | OEM  Part No. | PIX  Part No. |
|----------|---|--------------|--|--|
| 1 | Rotary Filter Drive | 1 | 340435152 | A-340435152 |
| 2 | Fan Drive | 2 | 340435150 | A-340435150 |
| 3 | - | 1 | 340433132 | A-340433132 |
| 4 | - | 1 | 340433262 | A-340433262 |
| 5 | - | 1 | 340433270 | A-340433270 |
| 6 | Hydraulic Pump Drive | 1 | 340433259 | A-340433259 |
| 7 | Fan Drive | 1 | 340435153 | A-340435153 |
| 8 | - | 1 | 340433268 | A-340433268 |
| 9 | - | 1 | 340433179 | A-340433179 |
| 10 | Post Cylinder Variator Drive | 1 | 344311318 | A-344311318 |
| 11 | Straw Elevator Drive | 1 | 344312128 | A-344312128 |
| 12 | Auger Drive Tailings Andgrain | 1 | 344311123 | A-344311123 |
| 13 | Fan Return Drive | 1 | 340433539 | A-340433539 |
| 14 | Straw Walker Drive | 1 | 340433474 | A-340433474 |
| 15 | Discharge Drive Grain Tank | 1 | 340433475 | A-340433475 |
| 16 | Central Return Drive | 1 | 340433984 | A-340433984 |
| 17 | Reel Drive Variable Speed | 1 | 340434138 | A-340434138 |
| 18 | - | 1 | 340433422 | A-340433422 |
| 19 | Chopper Drive | 1 | 344311130 | A-344311130 |
| 20 | Chopper Drive | 1 | 344311151 | A-344311151 |
| 21 | - | 1 | 340433253 | A-340433253 |
| 22 | Hydraulic Pump Drive | 1 | 344311227 | A-344311227 |
| 23 | Fan Drive | 1 | 340433405 | A-340433405 |
| 24 | Fan Drive | 1 | 340433159 | A-340433159 |

LAVERDA L 525 - MCS





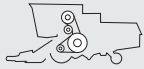

| Belt No. |  | No. of Belts | OEM  Part No. | PIX  Part No. |
|----------|---|--------------|--|--|
| 1 | Post Cylinder Variator Drive | 1 | 344311318 | A-344311318 |
| 2 | Straw Elevator Drive | 1 | 344312128 | A-344312128 |
| 3 | Auger Drive Tailings And Grain | 1 | 344311123 | A-344311123 |
| 4 | Fan Return Drive | 1 | 340433539 | A-340433539 |
| 5 | Straw Walker Drive | 1 | 340433474 | A-340433474 |
| 6 | Discharge Drive Grain Tank | 1 | 340433475 | A-340433475 |
| 7 | - | 1 | 340433179 | A-340433179 |
| 8 | Rotary Filter Drive | 1 | 340435152 | A-340435152 |
| 9 | Fan Drive | 2 | 340435150 | A-340435150 |
| 11 | Central Return Drive | 1 | 340433984 | A-340433984 |
| 12 | Reel Drive Variable Speed | 1 | 340434138 | A-340434138 |
| 13 | - | 1 | 340433422 | A-340433422 |
| 14 | - | 1 | 340433132 | A-340433132 |
| 15 | - | 1 | 340433262 | A-340433262 |
| 17 | - | 1 | 340433270 | A-340433270 |
| 18 | Chopper Drive | 1 | 344311130 | A-344311130 |
| 19 | Chopper Drive | 1 | 344311151 | A-344311151 |
| 20 | - | 1 | 340433253 | A-340433253 |
| 22 | Hydraulic Pump Drive | 1 | 344311227 | A-344311227 |
| 24 | Fan Drive | 1 | 340433405 | A-340433405 |
| 36 | Fan Drive | 1 | 340433159 | A-340433159 |
| 37 | Hydraulic Pump Drive | 1 | 340433259 | A-340433259 |
| 38 | Fan Drive | 1 | 340435153 | A-340435153 |

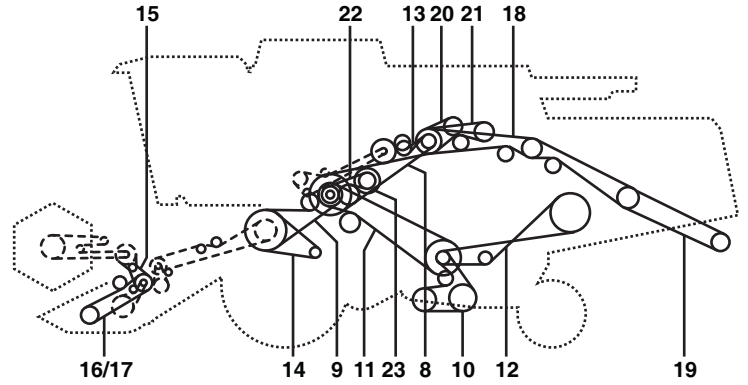
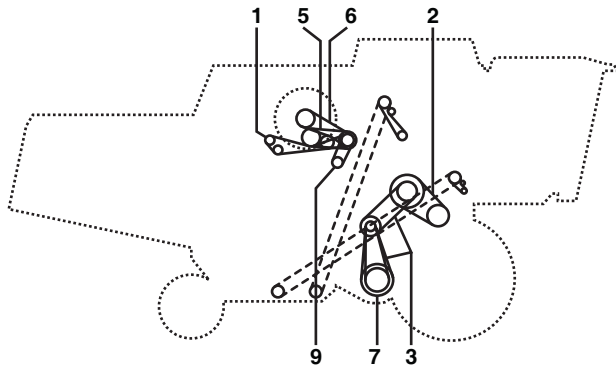

LAVERDA L 624

| Belt No. |  | No. of Belts | OEM  Part No. | PIX  Part No. |
|----------|---|--------------|--|--|
| 1 | Post Cylinder Variator Drive | 1 | 344311318 | A-344311318 |
| 2 | Straw Elevator Drive | 1 | 344311127 | A-344311127 |
| 2 | Straw Elevator Drive | 1 | 344312128 | A-344312128 |
| 3 | Auger Drive Tailings Andgrain | 1 | 344311123 | A-344311123 |
| 4 | Fan Return Drive | 1 | 340433539 | A-340433539 |
| 5 | Straw Elevator Drive | 1 | 340433474 | A-340433474 |
| 6 | Discharge Drive Grain Tank | 1 | 340433475 | A-340433475 |
| 7 | Rotary Filter Drive | 1 | 340433181 | A-340433181 |
| 9 | Fan Drive | 1 | 340435150 | A-340435150 |
| 11 | Central Return Drive | 1 | 340433984 | A-340433984 |
| 12 | Reel Drive Variable Speed | 1 | 340434138 | A-340434138 |
| 13 | - | 1 | 340433422 | A-340433422 |
| 14 | Compressor Drive | 1 | 340433131 | A-340433131 |
| 15 | - | 1 | 340433262 | A-340433262 |
| 17 | - | 1 | 340433270 | A-340433270 |
| 18 | Chopper Drive | 1 | 344311130 | A-344311130 |
| 19 | Chopper Drive | 1 | 344311151 | A-344311151 |
| 20 | - | 1 | 340433151 | A-340433151 |
| 20 | - | 1 | 340433253 | A-340433253 |
| 22 | Hydraulic Pump Drive | 1 | 344311227 | A-344311227 |
| 36 | Fan Drive | 1 | 340433159 | A-340433159 |
| 37 | - | 1 | 340433259 | A-340433259 |
| 38 | - | 1 | 340435153 | A-340435153 |

LAVERDA L 625



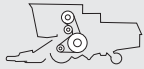

| Belt No. |  | No. of Belts | OEM  Part No. | PIX  Part No. |
|----------|---|--------------|--|--|
| 1 | - | 1 | 340433179 | A-340433179 |
| 2 | - | 2 | 340435124 | A-340435124 |
| 3 | Fan Drive | 2 | 340435150 | A-340435150 |
| 4 | - | 1 | 340433132 | A-340433132 |
| 5 | - | 1 | 340433262 | A-340433262 |
| 6 | - | 1 | 340433268 | A-340433268 |
| 7 | - | 1 | 340435153 | A-340435153 |
| 8 | Post Cylinder Variator Drive | 1 | 344311318 | A-344311318 |
| 9 | Straw Elevator Drive | 1 | 344312128 | A-344312128 |
| 10 | Auger Drive Tailings And Grain | 1 | 344311123 | A-344311123 |
| 11 | Fan Return Drive | 1 | 340433539 | A-340433539 |
| 12 | Straw Elevator Drive | 1 | 340433474 | A-340433474 |
| 13 | Discharge Drive Grain Tank | 1 | 340433475 | A-340433475 |
| 14 | Central Return Drive | 1 | 340433984 | A-340433984 |
| 15 | Reel Drive Variable Speed | 1 | 340434138 | A-340434138 |
| 16 | - | 1 | 340433422 | A-340433422 |
| 17 | - | 1 | 340433423 | A-340433423 |
| 18 | Chopper Drive | 1 | 344311130 | A-344311130 |
| 19 | Chopper Drive | 1 | 344311151 | A-344311151 |
| 20 | - | 1 | 340433253 | A-340433253 |
| 21 | Hydraulic Pump Drive | 1 | 344311227 | A-344311227 |
| 22 | Fan Drive | 1 | 340433405 | A-340433405 |
| 23 | - | 1 | 340433159 | A-340433159 |

| Belt No. |  | No. of Belts | OEM  Part No. | PIX  Part No. |
|----------|---|--------------|--|--|
| 1 | Post Cylinder Variator Drive | 1 | 344311318 | A-344311318 |
| 2 | Straw Elevator Drive | 1 | 344311127 | A-344311127 |
| 2 | Straw Elevator Drive | 1 | 344312128 | A-344312128 |
| 3 | Auger Drive Tailings Andgrain | 1 | 344311123 | A-344311123 |
| 4 | Fan Return Drive | 1 | 340433539 | A-340433539 |
| 5 | Straw Elevator Drive | 1 | 340433474 | A-340433474 |
| 6 | Discharge Drive Grain Tank | 1 | 340433475 | A-340433475 |
| 7 | Rotary Filter Drive | 1 | 340433181 | A-340433181 |
| 9 | Fan Drive | 1 | 340435150 | A-340435150 |
| 11 | Central Return Drive | 1 | 340433984 | A-340433984 |
| 12 | Reel Drive Variable Speed | 1 | 340434138 | A-340434138 |
| 13 | - | 1 | 340433422 | A-340433422 |
| 14 | Compressor Drive | 1 | 340433131 | A-340433131 |
| 15 | - | 1 | 340433262 | A-340433262 |
| 17 | - | 1 | 340433270 | A-340433270 |
| 18 | Chopper Drive | 1 | 344311130 | A-344311130 |
| 19 | Chopper Drive | 1 | 344311151 | A-344311151 |
| 20 | - | 1 | 340433151 | A-340433151 |
| 20 | - | 1 | 340433253 | A-340433253 |
| 22 | Hydraulic Pump Drive | 1 | 344311227 | A-344311227 |
| 36 | Fan Drive | 1 | 340433159 | A-340433159 |
| 38 | - | 1 | 340435153 | A-340435153 |

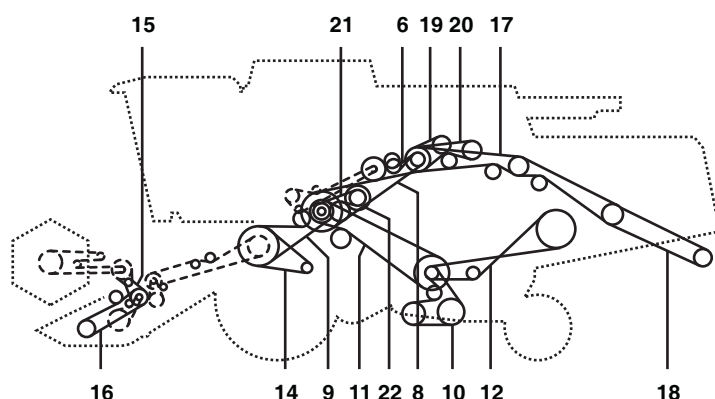
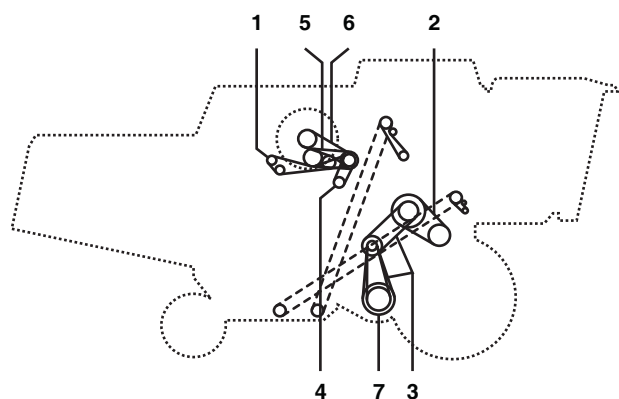

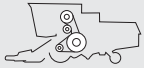
LAVERDA L 627 - INTEGRALE



| Belt No. |  | No. of Belts | OEM  Part No. | PIX  Part No. |
|----------|---|--------------|--|--|
| 1 | - | 1 | 340433179 | A-340433179 |
| 2 | Drum Vari - Drive | 2 | 340435124 | A-340435124 |
| 3 | Return Fan | 2 | 340435150 | A-340435150 |
| 4 | - | 1 | 340433132 | A-340433132 |
| 5 | - | 1 | 340433262 | A-340433262 |
| 6 | - | 1 | 340433268 | A-340433268 |
| 7 | Fan Drive | 1 | 340435153 | A-340435153 |
| 8 | Post Cylinder Variator Drive | 1 | 344311318 | A-344311318 |
| 9 | Straw Elevator Drive | 1 | 344312128 | A-344312128 |
| 10 | Auger Drive Tailings And Grain | 1 | 344311123 | A-344311123 |
| 11 | Fan Return Drive | 1 | 340433539 | A-340433539 |
| 12 | Straw Elevator Drive | 1 | 340433474 | A-340433474 |
| 13 | Discharge Drive Grain Tank | 1 | 340433475 | A-340433475 |
| 14 | Central Return Drive | 1 | 340433984 | A-340433984 |
| 15 | Reel Drive Variable Speed | 1 | 340434138 | A-340434138 |
| 16 | - | 1 | 340433422 | A-340433422 |
| 17 | Chopper Drive | 1 | 344311130 | A-344311130 |
| 18 | Chopper Drive | 1 | 344311151 | A-344311151 |
| 19 | - | 1 | 340433253 | A-340433253 |
| 20 | Hydraulic Pump Drive | 1 | 344311227 | A-344311227 |
| 21 | Fan Drive | 1 | 340433405 | A-340433405 |
| 22 | Fan Drive | 1 | 340433159 | A-340433159 |

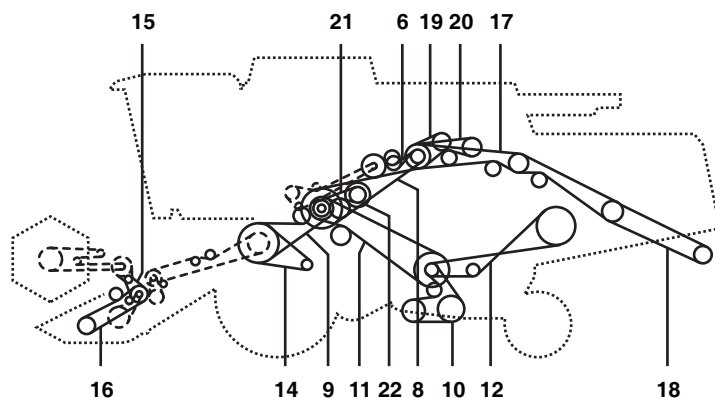
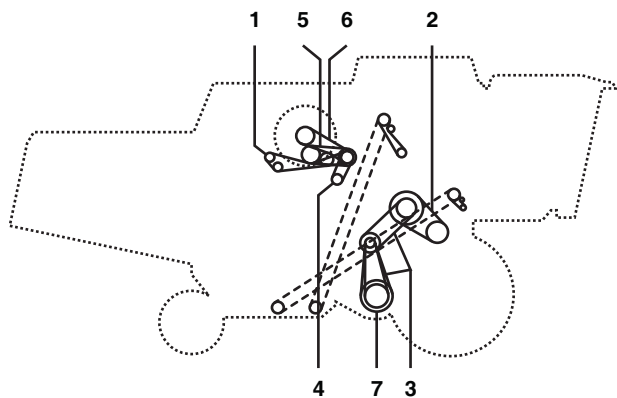

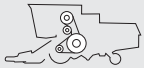
LAVERDA L 627 - MCS



| Belt No. |  | No. of Belts | OEM  Part No. | PIX  Part No. |
|----------|---|--------------|--|--|
| 1 | - | 1 | 340433179 | A-340433179 |
| 2 | Drum Vari - Drive | 2 | 340435124 | A-340435124 |
| 3 | Return Fan | 2 | 340435150 | A-340435150 |
| 4 | - | 1 | 340433132 | A-340433132 |
| 5 | - | 1 | 340433262 | A-340433262 |
| 6 | - | 1 | 340433268 | A-340433268 |
| 7 | Fan Drive | 1 | 340435153 | A-340435153 |
| 8 | Post Cylinder Variator Drive | 1 | 344311318 | A-344311318 |
| 9 | Straw Elevator Drive | 1 | 344312128 | A-344312128 |
| 10 | Auger Drive Tailings Andgrain | 1 | 344311123 | A-344311123 |
| 11 | Fan Return Drive | 1 | 340433539 | A-340433539 |
| 12 | Straw Elevator Drive | 1 | 340433474 | A-340433474 |
| 13 | Discharge Drive Grain Tank | 1 | 340433475 | A-340433475 |
| 14 | Central Return Drive | 1 | 340433984 | A-340433984 |
| 15 | Reel Drive Variable Speed | 1 | 340434138 | A-340434138 |
| 16 | - | 1 | 340433422 | A-340433422 |
| 17 | Chopper Drive | 1 | 344311130 | A-344311130 |
| 18 | Chopper Drive | 1 | 344311151 | A-344311151 |
| 19 | - | 1 | 340433253 | A-340433253 |
| 20 | Hydraulic Pump Drive | 1 | 344311227 | A-344311227 |
| 21 | Fan Drive | 1 | 340433405 | A-340433405 |
| 22 | Fan Drive | 1 | 340433159 | A-340433159 |

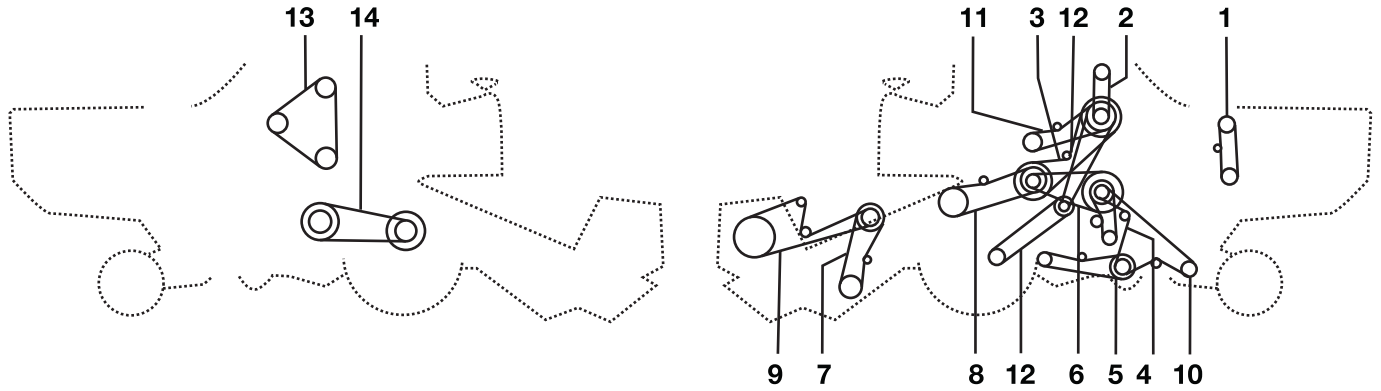

LAVERDA M 84



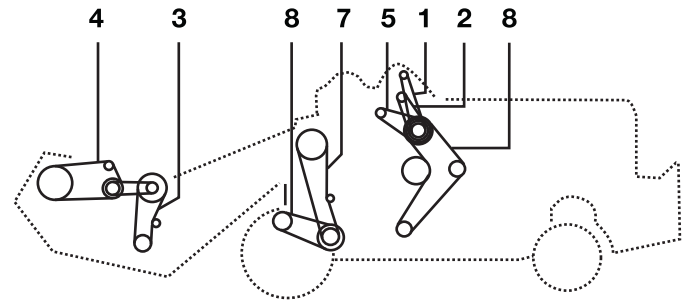
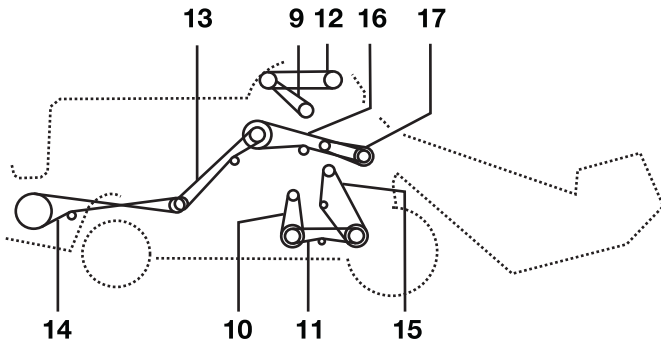

| Belt No. |  | No. of Belts | OEM  Part No. | PIX  Part No. |
|----------|---|--------------|--|--|
| 1 | | 1 | 340433131 | A-340433131 |
| 2 | | 1 | 340433223 | A-340433223 |
| 3 | | 1 | 340433266 | A-340433266 |
| 4 | | 1 | 340433274 | A-340433274 |
| 4 | | 1 | 340433284 | A-340433284 |
| 5 | | 1 | 340433281 | A-340433281 |
| 6 | | 1 | 340433414 | A-340433414 |
| 7 | | 1 | 340433414 | A-340433414 |
| 7 | | 1 | 340433419 | A-340433419 |
| 8 | | 1 | 340433427 | A-340433427 |
| 9 | | 1 | 340433440 | A-340433440 |
| 9 | | 1 | 340433441 | A-340433441 |
| 10 | | 1 | 340433970 | A-340433970 |
| 11 | | 1 | 344311218 | A-344311218 |
| 12 | | 1 | 340435120 | A-340435120 |
| 14 | | 1 | 340435135 | A-340435135 |
| 14 | | 1 | 340435138 | A-340435138 |

LAVERDA M 90



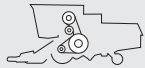

| Belt No. |  | No. of Belts | OEM  Part No. | PIX  Part No. |
|----------|---|--------------|--|--|
| 2 | Fan Drive Variable Speed | 1 | 340433176 | A-340433176 |
| 3 | Return Drive | 1 | 340433415 | A-340433415 |
| 4 | Reel Drive | 1 | 340433433 | A-340433433 |
| 5 | De-awner Drive | 1 | 340433425 | A-340433425 |
| 7 | Threshing Drum Variator drive | 1 | 340434247 | A-340434247 |
| 8 | Traction Drive | 1 | 340435100 | A-340435100 |
| 12 | Elevator Drive Grain | 1 | 340433272 | A-340433272 |
| 13 | - | 1 | 340433441 | A-340433441 |
| 14 | - | 1 | 340433453 | A-340433453 |
| 15 | Fan Drive | 1 | 340433281 | A-340433281 |
| 16 | Cylinder Drive | 1 | 340433961 | A-340433961 |
| 17 | De-awner Drive | 1 | 340435100 | A-340435100 |

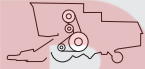

LAVERDA M 92

| Belt No. |  | No. of Belts | OEM  Part No. | PIX  Part No. |
|----------|---|--------------|--|--|
| 1 | Unloading System - Vibrator | 1 | 340433980 | A-340433980 |
| 2 | Threshing Drive | 1 | 344311217 | A-344311217 |
| 3 | Auger Drive | 1 | 340433252 | A-340433252 |
| 4 | Pump Drive | 1 | 340433223 | A-340433223 |
| 5 | Traction Vari-drive | 1 | 340435120 | A-340435120 |
| 6 | Return Drive | 1 | 340433412 | A-340433412 |
| 7 | Straw Walker - Auger Drive | 1 | 340433970 | A-340433970 |
| 8 | Main Fan | 1 | 340433283 | A-340433283 |
| 9 | Upper Shaft Elevator | 1 | 340433432 | A-340433432 |
| 10 | Reel Drive | 1 | 340433458 | A-340433458 |
| 12 | - | 1 | 340433174 | A-340433174 |
| 14 | Cylinder Vari-drive | 1 | 340435138 | A-340435138 |
| 15 | Unloading System - Vibrator | 1 | 340433980 | A-340433980 |



LAVERDA M 100

| Belt No. |  | No. of Belts | OEM  Part No. | PIX  Part No. |
|----------|---|--------------|--|--|
| 1 | Hydraulic Pump Drive | 1 | 340432232 | A-340432232 |
| 1 | Hydraulic Pump Drive | 1 | 340432239 | A-340432239 |
| 2 | De-awner Beaters Drive | 1 | 340432437 | A-340432437 |
| 2 | De-awner Padd. Drive | 1 | 340432438 | A-340432438 |
| 3 | Fan Drive | 1 | 340433289 | A-340433289 |
| 4 | Straw Walker Drive | 1 | 340433308 | A-340433308 |
| 5 | Reel Drive Variable Speed | 1 | 340433414 | A-340433414 |
| 5 | Reel Drive Variable Speed | 1 | 340433419 | A-340433419 |
| 6 | Elevator Drive (upper) Shaft | 1 | 340433427 | A-340433427 |
| 7 | Reel Drive | 1 | 340433440 | A-340433440 |
| 7 | Reel Drive | 1 | 340433441 | A-340433441 |
| 8 | Central Return Drive | 1 | 340433440 | A-340433440 |
| 9 | Auger Drive Tailings And Grain | 1 | 340433963 | A-340433963 |
| 10 | Threshing Drum Variator Drive | 1 | 340434245 | A-340434245 |
| 12 | Discharge Drive Grain Tank | 1 | 340432244 | A-340432244 |
| 12 | Discharge Drive Grain Tank | 1 | 340432246 | A-340432246 |
| 13 | Beater Drum Drive | 1 | 340435135 | A-340435135 |
| 13 | Beater Drum Drive | 1 | 340435138 | A-340435138 |

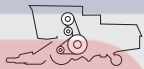

LAVERDA M 100 AL

| Belt No. |  | No. of Belts | OEM  Part No. | PIX  Part No. |
|----------|---|--------------|--|--|
| 1 | Elevator Drive (upper) Shaft | 1 | 340433427 | A-340433427 |
| 2 | Threshing Drum Variator Drive | 1 | 340434245 | A-340434245 |
| 4 | Hydraulic Pump Drive | 1 | 340432239 | A-340432239 |
| 5 | Central Return Drive | 1 | 340433440 | A-340433440 |
| 6 | De-awner Beaters Drive | 1 | 340432438 | A-340432438 |
| 7 | Fan Drive | 1 | 340433289 | A-340433289 |
| 8 | Auger Drive Tailings and Grain | 1 | 340433963 | A-340433963 |
| 9 | Straw Walker Drive | 1 | 340433308 | A-340433308 |
| 10 | Reel Drive | 1 | 340433441 | A-340433441 |
| 11 | Reel Drive Variable Speed | 1 | 340434140 | A-340434140 |
| 12 | Beater Drum Drive | 1 | 340435138 | A-340435138 |
| 13 | Discharge Drive Grain Tank | 1 | 340432244 | A-340432244 |

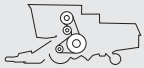

LAVERDA M 112

| Belt No. |  | No. of Belts | OEM  Part No. | PIX  Part No. |
|----------|--|--------------|---|---|
| 1 | Reel Drive Variable Speed | 1 | 340434140 | A-340434140 |
| 2 | Blower Drive | 1 | 340433182 | A-340433182 |
| 3 | Threshing Drum Variator drive | 1 | 344311221 | A-344311221 |
| 4 | Discharge Drive Grain Tank | 1 | 340433417 | A-340433417 |
| 6 | Oil Pump Drive | 1 | 340432244 | A-340432244 |
| 8 | Fan Drive | 1 | 340433289 | A-340433289 |
| 9 | Straw Walker Drive | 1 | 340433455 | A-340433455 |
| 10 | Auger Drive Tailings and grain | 1 | 340433430 | A-340433430 |
| 11 | Fan Return Drive | 1 | 340433409 | A-340433409 |
| 12 | Fan Drive | 1 | 340433410 | A-340433410 |
| 13 | Straw Elevator Drive | 1 | 340433531 | A-340433531 |
| 14 | Reel Drive | 1 | 340433435 | A-340433435 |
| 15 | De-awner Drive | 1 | 340433456 | A-340433456 |
| 16 | Selector Auger Drive | 1 | 340433236 | A-340433236 |
| 17 | Rotary Filter Drive | 1 | 340433134 | A-340433134 |
| 18 | Rotary Filter Drive | 1 | 340433162 | A-340433162 |
| 19 | Cylinder Variator drive | 1 | 340435146 | A-340435146 |

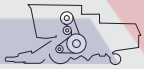

LAVERDA M 112 AL

| Belt No. |  | No. of Belts | OEM  Part No. | PIX  Part No. |
|----------|---|--------------|--|--|
| 1 | Blower Drive | 1 | 340433182 | A-340433182 |
| 2 | Straw Elevator Drive | 1 | 340433531 | A-340433531 |
| 3 | Threshing Drum Variator drive | 1 | 344311221 | A-344311221 |
| 4 | Discharge Drive Grain Tank | 1 | 340433417 | A-340433417 |
| 5 | Hydraulic Pump Drive | 1 | 340432244 | A-340432244 |
| 6 | Hydrostatic Pump Drive | 1 | 344311212 | A-344311212 |
| 7 | Elevator Drive Unit | 1 | 340433289 | A-340433289 |
| 8 | Straw Walker Drive | 1 | 340433455 | A-340433455 |
| 9 | Central Return Drive | 1 | 340433537 | A-340433537 |
| 10 | Fan Drive | 1 | 340433410 | A-340433410 |
| 11 | Fan Drive | 1 | 340433409 | A-340433409 |
| 12 | Elevator Tailings And Grain | 1 | 340433430 | A-340433430 |
| 13 | Selector Auger Drive | 1 | 340433236 | A-340433236 |
| 14 | De-awner Drive | 1 | 340433456 | A-340433456 |
| 15 | Rotary Filter Drive | 1 | 340433134 | A-340433134 |
| 16 | Rotary Filter Drive | 1 | 340433162 | A-340433162 |
| 17 | Cylinder Variator drive | 1 | 340435146 | A-340435146 |
| 18 | Reel Drive Variable Speed | 1 | 340434140 | A-340434140 |
| 19 | Reel Drive | 1 | 340433456 | A-340433456 |



LAVERDA M 120

| Belt No. |  | No. of Belts | OEM  Part No. | PIX  Part No. |
|----------|---|--------------|--|--|
| 1 | Reel Drive | 1 | 340433435 | A-340433435 |
| 2 | Reel Drive Variable Speed | 1 | 340434140 | A-340434140 |
| 3 | Elevator Drive (upper) Shaft | 1 | 340433531 | A-340433531 |
| 4 | Threshing Drum Variator Drive | 1 | 340434250 | A-340434250 |
| 6 | Hydraulic Pump Drive | 1 | 340432232 | A-340432232 |
| 7 | Central Return Drive | 1 | 340433537 | A-340433537 |
| 8 | De-awner Padd. Drive | 1 | 340432436 | A-340432436 |
| 8 | De-awner Beaters Drive | 1 | 340432437 | A-340432437 |
| 10 | Auger Drive Tailings and Grain | 1 | 340432433 | A-340432433 |
| 11 | Straw Walker Drive | 1 | 340433440 | A-340433440 |
| 13 | Discharge Drive Grain Tank | 1 | 340432244 | A-340432244 |
| 14 | Beater Drum Drive | 2 | 340435117 | A-340435117 |

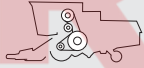

LAVERDA M 132

| Belt No. |  | No. of Belts | OEM  Part No. | PIX  Part No. |
|----------|---|--------------|--|--|
| 1 | Reel Drive | 1 | 340433435 | A-340433435 |
| 2 | Reel Drive Variable Speed | 1 | 340434140 | A-340434140 |
| 3 | Blower Drive | 1 | 340433182 | A-340433182 |
| 4 | Straw Elevator Drive | 1 | 340433531 | A-340433531 |
| 5 | Threshing Drum Variator Drive | 1 | 344311221 | A-344311221 |
| 6 | Discharge Drive Grain Tank | 1 | 340433417 | A-340433417 |
| 7 | Oil Pump Drive | 1 | 340432244 | A-340432244 |
| 9 | Central Return Drive | 1 | 340433537 | A-340433537 |
| 10 | Fan Grain Tank | 1 | 340433289 | A-340433289 |
| 11 | Straw Walker Drive | 1 | 340433455 | A-340433455 |
| 12 | Auger Drive Tailings And Grain | 1 | 340433430 | A-340433430 |
| 13 | Fan Drive | 1 | 340433409 | A-340433409 |
| 14 | Fan Drive | 1 | 340433410 | A-340433410 |
| 15 | Selector Auger Drive | 1 | 340433236 | A-340433236 |
| 16 | De-awner Return Drive | 1 | 340433456 | A-340433456 |
| 17 | Rotary Filter Return Drive | 1 | 340433134 | A-340433134 |
| 18 | Rotary Filter Drive | 1 | 340433162 | A-340433162 |

LAVERDA M 150

| Belt No. |  | No. of Belts | OEM  Part No. | PIX  Part No. |
|----------|---|--------------|--|--|
| 1 | Reel Drive | 1 | 340433435 | A-340433435 |
| 2 | Reel Drive Variable Speed | 1 | 340434140 | A-340434140 |
| 3 | Straw Elevator Drive | 1 | 340433531 | A-340433531 |
| 4 | Threshing Drum Variator Drive | 1 | 344311315 | A-344311315 |
| 5 | Discharge Drive Grain Tank | 1 | 340433417 | A-340433417 |
| 6 | Hydraulic Pump Drive | 1 | 340432244 | A-340432244 |
| 9 | Straw Walker Drive | 1 | 340433442 | A-340433442 |
| 10 | Central Return Drive | 1 | 340433537 | A-340433537 |
| 11 | Fan Return Drive | 1 | 340433413 | A-340433413 |
| 12 | Auger Drive Tailings And Grain | 1 | 340433440 | A-340433440 |
| 13 | Fan Drive | 1 | 340433406 | A-340433406 |
| 14 | Selector Auger Drive | 1 | 340433281 | A-340433281 |
| 15 | De-awner Drive | 1 | 340433431 | A-340433431 |
| 16 | Rotary Filter Return Drive | 1 | 340433133 | A-340433133 |
| 17 | Rotary Filter Drive | 1 | 340433184 | A-340433184 |
| 18 | Rotary Filter Drive | 1 | 340433143 | A-340433143 |
| 19 | Alternator Drive | 1 | 8822704 | A-8822704 |
| 20 | De-awner Return Drive | 1 | 340432433 | A-340432433 |
| 22 | Fan Return Drive | 1 | 340433184 | A-340433184 |
| 23 | Blower Drive | 1 | 340433157 | A-340433157 |

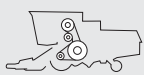

LAVERDA M 152

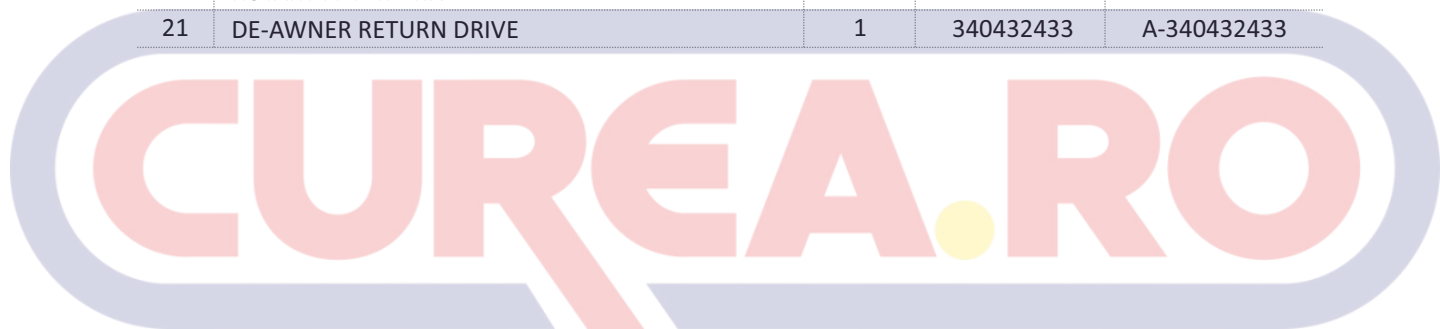
| Belt No. |  | No. of Belts | OEM  Part No. | PIX  Part No. |
|----------|---|--------------|--|--|
| 1 | REEL DRIVE VARIABLE SPEED | 1 | 340434140 | A-340434140 |
| 2 | BLOWER DRIVE | 1 | 340433182 | A-340433182 |
| 3 | THRESHING DRUM VARIATOR DRIVE | 1 | 344311315 | A-344311315 |
| 4 | DISCHARGE DRIVE GRAIN TANK | 1 | 340433417 | A-340433417 |
| 6 | OIL PUMP DRIVE | 1 | 340432244 | A-340432244 |
| 8 | STRAW WALKER DRIVE | 1 | 340433442 | A-340433442 |
| 9 | AUGER DRIVE TAILINGS AND GRAIN | 1 | 340433440 | A-340433440 |
| 10 | CENTRAL RETURN DRIVE | 1 | 340433537 | A-340433537 |
| 11 | FAN RETURN DRIVE | 1 | 340433413 | A-340433413 |
| 12 | FAN DRIVE | 1 | 340433406 | A-340433406 |
| 13 | STRAW ELEVATOR DRIVE | 1 | 340433531 | A-340433531 |
| 14 | REEL DRIVE | 1 | 340433435 | A-340433435 |
| 15 | SELECTOR AUGER DRIVE | 1 | 340433281 | A-340433281 |
| 16 | DE-AWNER DRIVE | 1 | 340433431 | A-340433431 |
| 17 | ROTARY FILTER RETURN DRIVE | 1 | 340433133 | A-340433133 |
| 18 | ROTARY FILTER DRIVE | 1 | 340433143 | A-340433143 |
| 19 | ROTARY FILTER DRIVE | 1 | 340433184 | A-340433184 |
| 21 | DE-AWNER RETURN DRIVE | 1 | 340432433 | A-340432433 |



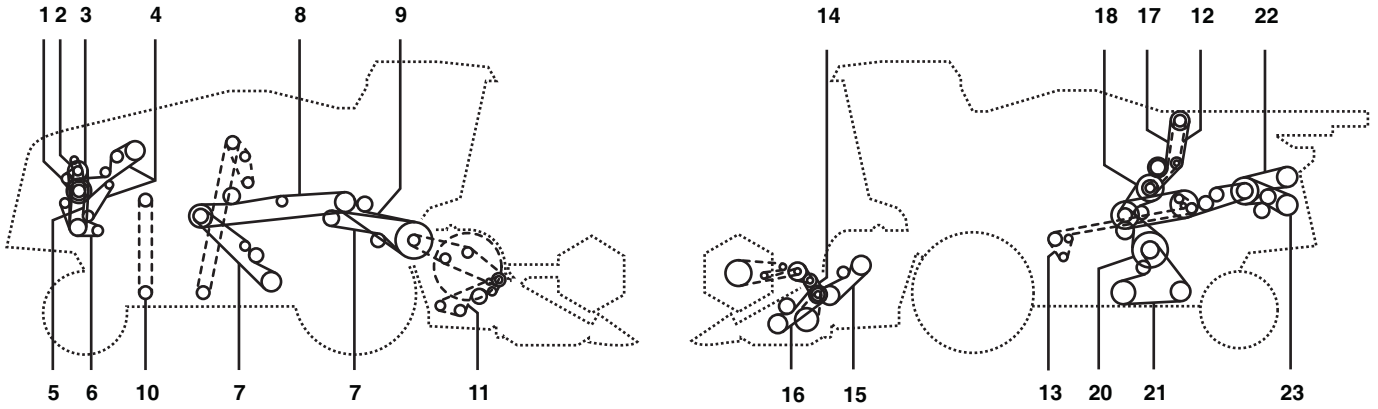

LAVERDA MX 240



| Belt No. |  | No. of Belts | OEM  Part No. | PIX  Part No. |
|----------|---|--------------|--|--|
| 3 | - | 1 | 340433286 | A-340433286 |
| 4 | Oil Cooling Fan | 1 | 340433183 | A-340433183 |
| 6 | Compressor Drive | 1 | 340433125 | A-340433125 |
| 7 | - | 1 | 340433311 | A-340433311 |
| 8 | Cylinder Drive | 1 | 344311137 | A-344311137 |
| 9 | Cylinder Drive | 1 | 344311127 | A-344311127 |
| 14 | Reel Vari - Drive | 1 | 340434138 | A-340434138 |
| 16 | - | 1 | 340433422 | A-340433422 |
| 18 | Distribution Auger | 1 | 344311113 | A-344311113 |
| 20 | - | 1 | 344311117 | A-344311117 |
| 23 | Hydraulic Pump Drive | 1 | 344311227 | A-344311227 |

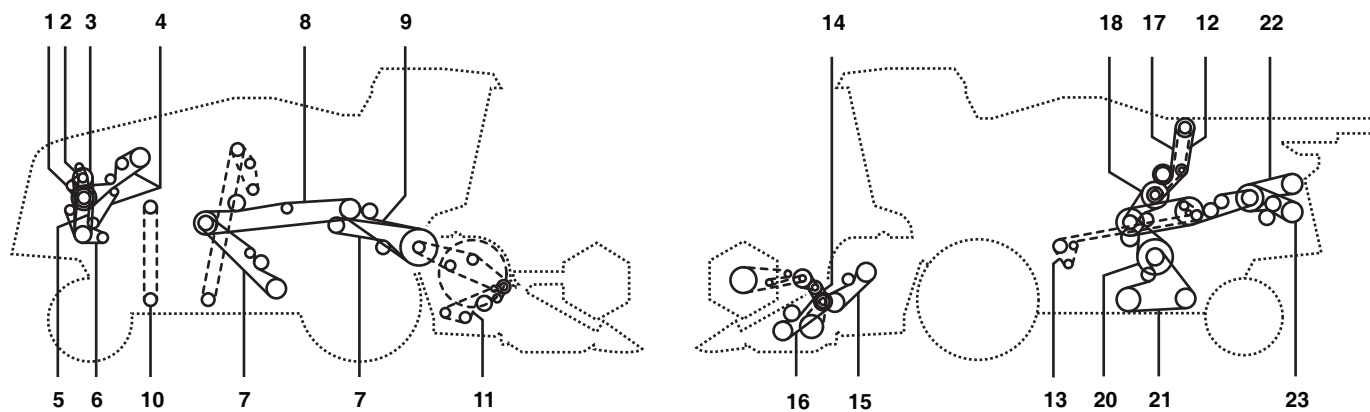

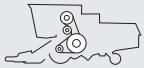
LAVERDA MX 240 R



| Belt No. |  | No. of Belts | OEM  Part No. | PIX  Part No. |
|----------|---|--------------|--|--|
| 1 | - | 1 | 4813541 | A-4813541 |
| 3 | - | 1 | 340433286 | A-340433286 |
| 4 | OIL COOLINGFAN | 1 | 340433183 | A-340433183 |
| 6 | COMPRESSOR DRIVE | 1 | 340433125 | A-340433125 |
| 7 | - | 1 | 340433311 | A-340433311 |
| 8 | CYLINDER DRIVE | 1 | 344311137 | A-344311137 |
| 9 | CYLINDER DRIVE | 1 | 344311127 | A-344311127 |
| 14 | REEL VARI - DRIVE | 1 | 340434138 | A-340434138 |
| 16 | - | 1 | 340433422 | A-340433422 |
| 18 | DISTRIBUTION AUGER | 1 | 344311113 | A-344311113 |
| 20 | - | 1 | 344311117 | A-344311117 |
| 23 | HYDRAULIC PUMP DRIVE | 1 | 344311227 | A-344311227 |

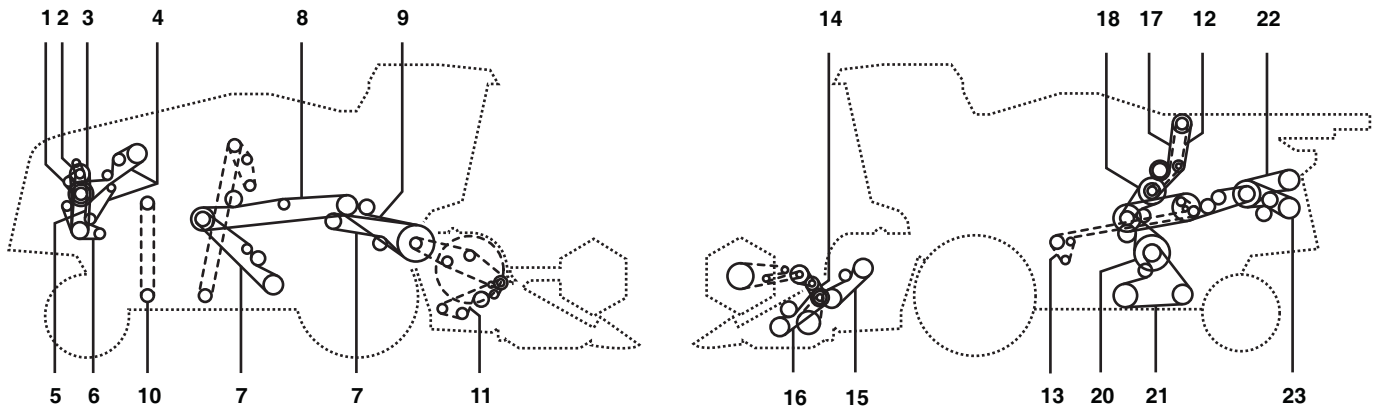

LAVERDA MX 300





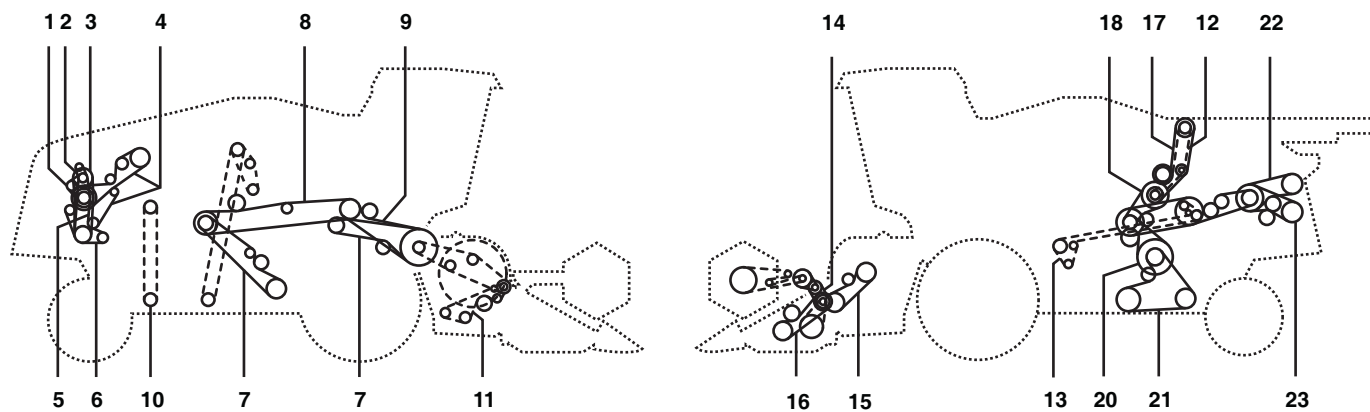

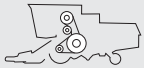
| Belt No. |  | No. of Belts | OEM  Part No. | PIX  Part No. |
|----------|---|--------------|--|--|
| 1 | - | 1 | 4813541 | A-4813541 |
| 4 | Oil Cooling Fan | 1 | 340433183 | A-340433183 |
| 6 | Compressor Drive | 1 | 340433125 | A-340433125 |
| 7 | - | 1 | 340433311 | A-340433311 |
| 8 | Cylinder Drive | 1 | 344311137 | A-344311137 |
| 9 | Cylinder Drive | 1 | 344311127 | A-344311127 |
| 14 | Reel Vari - Drive | 1 | 340434138 | A-340434138 |
| 16 | - | 1 | 340433422 | A-340433422 |
| 18 | Distribution Auger | 1 | 344311113 | A-344311113 |
| 20 | - | 1 | 344311117 | A-344311117 |
| 23 | Hydraulic Pump Drive | 1 | 344311227 | A-344311227 |

LAVERDA MX 300 R

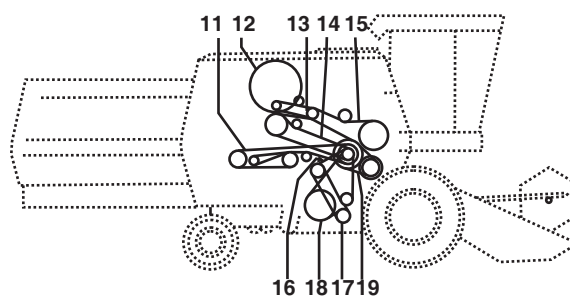
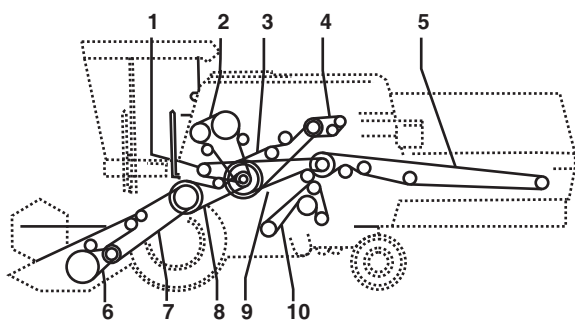



| Belt No. |  | No. of Belts | OEM  Part No. | PIX  Part No. |
|----------|---|--------------|--|--|
| 4 | Oil Coolingfan | 1 | 340433183 | A-340433183 |
| 6 | Compressor Drive | 1 | 340433125 | A-340433125 |
| 7 | - | 1 | 340433311 | A-340433311 |
| 8 | Cylinder Drive | 1 | 344311137 | A-344311137 |
| 9 | Cylinder Drive | 1 | 344311127 | A-344311127 |
| 14 | Reel Vari - Drive | 1 | 340434138 | A-340434138 |
| 16 | - | 1 | 340433422 | A-340433422 |
| 18 | Distribution Auger | 1 | 344311113 | A-344311113 |
| 20 | - | 1 | 344311117 | A-344311117 |
| 23 | Hydraulic Pump Drive | 1 | 344311227 | A-344311227 |



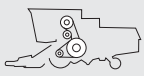

| Belt No. |  | No. of Belts | OEM  Part No. | PIX  Part No. |
|----------|---|--------------|--|--|
| 1 | Retuens Auger | - | D41964300 | A-D41964300 |
| 2 | Counter Shaft | - | D41972100 | A-D41972100 |
| 3 | Selector Drive | - | D41991600 | A-D41991600 |
| 4 | Hydraulic Pump Drive | - | D41991400 | A-D41991400 |
| 5 | Straw Chopper | - | D41958500 | A-D41958500 |
| 6 | Feed Auger | - | D41929400 | A-D41929400 |
| 7 | Feed Elevator | - | D41989100 | A-D41989100 |
| 8 | Upper Feed Shaft | - | D41988900 | A-D41988900 |
| 9 | Straw Chopper | - | D41955900 | A-D41955900 |
| 10 | Eccentric Shaft | - | D41972800 | A-D41972800 |
| 11 | Awner Shaft | - | D41978500 | A-D41978500 |
| 12 | Rotary Shaft | - | D41912300 | A-D41912300 |
| 13 | Intermediate Shaft | - | D41927800 | A-D41927800 |
| 14 | Grain Elevator | - | D41935700 | A-D41935700 |
| 15 | Discharge Auger | - | D41988700 | A-D41988700 |
| 16 | Fan Variator | - | D41926300 | A-D41926300 |
| 17 | Main Fan Drive | - | D41930300 | A-D41930300 |
| 18 | Eccentric Shaft | - | D41935500 | A-D41935500 |
| 19 | Threshing Drum | - | D41980800 | A-D41980800 |

MASSEY FERGUSON 27

| Belt No. |  | No. of Belts | OEM  Part No. | PIX  Part No. |
|----------|---|--------------|--|--|
| 8 | - | 3 | 41934800 | A-41934800 |
| 10 | - | 1 | 41929000 | A-41929000 |
| 14 | - | 2 | 41936200 | A-41936200 |

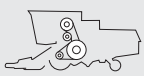

MASSEY FERGUSON 29

| Belt No. |  | No. of Belts | OEM  Part No. | PIX  Part No. |
|----------|---|--------------|--|--|
| 8 | - | 3 | 41934800 | A-41934800 |
| 14 | - | 2 | 41936200 | A-41936200 |

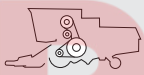

MASSEY FERGUSON 31

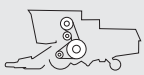
| Belt No. |  | No. of Belts | OEM  Part No. | PIX  Part No. |
|----------|---|--------------|--|--|
| 8 | - | 3 | 41934800 | A-41934800 |
| 14 | - | 2 | 41936200 | A-41936200 |



MASSEY FERGUSON 31 OLD

| Belt No. |  | No. of Belts | OEM  Part No. | PIX  Part No. |
|----------|---|--------------|--|--|
| 1 | Feeder Drum - Countershaft | 1 | 402604M1 | A-402604M1 |
| 2 | Straw Walker Drive | 1 | 410647M1 | A-410647M1 |
| 3 | Knife Drive Reduction | 1 | 410957M1 | A-410957M1 |
| 4 | Feeder Auger | 1 | 410958M1 | A-410958M1 |
| 5 | Knife Drive | 1 | 410959M1 | A-410959M1 |
| 6 | Threshing Drum Variator drive | 1 | 410617M1 | A-410617M1 |
| 7 | Main Drive | 1 | 411218M1 | A-411218M1 |
| 9 | Clutch Grain Tank | 1 | 411020M1 | A-411020M1 |
| 10 | Table Drive | 1 | 410919M1 | A-410919M1 |
| 11 | Straw Baler | 1 | 405928M1 | A-405928M1 |

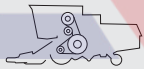

MASSEY FERGUSON 86 (F)

| Belt No. |  | No. of Belts | OEM  Part No. | PIX  Part No. |
|----------|---|--------------|--|--|
| 1 | Table Feeder Drum | 1 | 412236M1 | A-412236M1 |
| 2 | Tank Unloader Drive | 1 | 412074M1 | A-412074M1 |
| 3 | Fanning Mill (upper) | 1 | 402605M1 | A-402605M1 |
| 4 | Hydraulic Pump Drive | 1 | 402177M1 | A-402177M1 |
| 4 | Hydraulic Pump Drive | 1 | 402604M1 | A-402604M1 |
| 5 | Beater Drive | 1 | 402608M3 | A-402608M3 |
| 5 | Beater Drive | 1 | 413122M2 | A-413122M2 |
| 7 | Straw Walker Shaker | 1 | 402603M1 | A-402603M1 |
| 8 | Traction (upper) | 1 | 412333M1 | A-412333M1 |
| 8 | Traction (upper) | 1 | 905921M1 | A-905921M1 |
| 9 | Traction (lower) | 1 | 401110M1 | A-401110M1 |
| 10 | Reducer | 1 | 412237M1 | A-412237M1 |
| 11 | Auger Drive (front) | 1 | 412399M1 | A-412399M1 |
| 12 | Knife Drive | 1 | 402607M1 | A-402607M1 |
| 15 | Fanning Mill | 1 | 402604M1 | A-402604M1 |



MASSEY FERGUSON 87 (F)

| Belt No. |  | No. of Belts | OEM  Part No. | PIX  Part No. |
|----------|---|--------------|--|--|
| 1 | Table Feeder Drum | 1 | 412236M1 | A-412236M1 |
| 2 | Tank Unloader Drive | 1 | 412074M1 | A-412074M1 |
| 3 | Fanning Mill (upper) | 1 | 402605M1 | A-402605M1 |
| 4 | Hydraulic Pump Drive | 1 | 402177M1 | A-402177M1 |
| 4 | Hydraulic Pump Drive | 1 | 417468M1 | A-417468M1 |
| 5 | Beater Drive | 1 | 402608M3 | A-402608M3 |
| 7 | Straw Walker Shaker | 1 | 402603M1 | A-402603M1 |
| 8 | Traction (upper) | 1 | 905921M1 | A-905921M1 |
| 9 | Traction (lower) | 1 | 401110M1 | A-401110M1 |
| 10 | Reducer | 1 | 412237M1 | A-412237M1 |
| 11 | Auger Drive (front) | 1 | 412399M1 | A-412399M1 |
| 12 | Knife Drive | 1 | 402607M1 | A-402607M1 |
| 15 | Fanning Mill | 1 | 621262M1 | A-621262M1 |

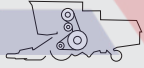

MASSEY FERGUSON 86 - 87 OLD

| Belt No. |  | No. of Belts | OEM  Part No. | PIX  Part No. |
|----------|---|--------------|--|--|
| 1 | Traction Drive | 1 | 401109M1 | A-401109M1 |
| 1 | Traction Drive | 1 | 412333M1 | A-412333M1 |
| 2 | Traction Drive | 1 | 401110M1 | A-401110M1 |
| 3 | Hydraulic Pump Drive | 1 | 402177M1 | A-402177M1 |
| 3 | Hydraulic Pump Drive | 1 | 403041M1 | A-403041M1 |
| 4 | Straw Walker Drive | 1 | 402603M1 | A-402603M1 |
| 5 | Knife Drive | 1 | 402607M1 | A-402607M1 |
| 6 | Beater Behind Cylinder | 1 | 402608M3 | A-402608M3 |
| 7 | Knife Drive (upper) | 1 | 412237M1 | A-412237M1 |
| 8 | Feeder Auger | 1 | 412399M1 | A-412399M1 |
| 9 | Straw Baler | 1 | 328656M1 | A-328656M1 |
| 10 | Fanning Mill | 1 | 402604M1 | A-402604M1 |
| 11 | Fanning Mill (upper) | 1 | 402605M1 | A-402605M1 |
| 12 | Tank Unloader Drive | 1 | 412074M1 | A-412074M1 |
| 13 | Feeder Drive | 1 | 412236M1 | A-412236M1 |



MASSEY FERGUSON 186 (F)

| Belt No. |  | No. of Belts | OEM  Part No. | PIX  Part No. |
|----------|---|--------------|--|--|
| 1 | Table Feeder Drum | 1 | 1724154M1 | A-1724154M1 |
| 1 | Table Feeder Drum | 1 | 417974M1 | A-417974M1 |
| 2 | Tank Unloader Drive | 1 | 621259M1 | A-621259M1 |
| 3 | Fanning Mill (upper) | 1 | 621261M1 | A-621261M1 |
| 5 | Beater Drive | 1 | 418232M1 | A-418232M1 |
| 8 | Traction (upper) | 1 | 905921M1 | A-905921M1 |
| 9 | Traction (lower) | 1 | 905920M1 | A-905920M1 |
| 10 | Reducer | 1 | 417972M1 | A-417972M1 |
| 11 | Auger Drive (front) | 1 | 418209M1 | A-418209M1 |
| 12 | Knife Drive | 1 | 1722835M1 | A-1722835M1 |
| 12 | Knife Drive | 1 | 402607M1 | A-402607M1 |
| 15 | Fanning Mill | 1 | 621262M1 | A-621262M1 |



MASSEY FERGUSON 186 OLD

| Belt No. |  | No. of Belts | OEM  Part No. | PIX  Part No. |
|----------|---|--------------|--|--|
| 0 | Radiator Fan Drive | 1 | 893575M1 | A-893575M1 |
| 4 | Traction Drive | 1 | 401109M1 | A-401109M1 |
| 5 | Traction Drive | 1 | 417995M1 | A-417995M1 |
| 6 | Knife Drive (upper) | 1 | 417972M1 | A-417972M1 |
| 7 | Feeder Drive | 1 | 1724154M1 | A-1724154M1 |
| 7 | Feeder Drive | 1 | 417974M1 | A-417974M1 |
| 8 | Knife Drive | 1 | 402607M1 | A-402607M1 |
| 9 | Feeder Auger | 1 | 418209M1 | A-418209M1 |
| 10 | Tank Unloader Drive | 1 | 621259M1 | A-621259M1 |
| 11 | Beater Behind Cylinder | 1 | 418232M1 | A-418232M1 |
| 12 | Hydraulic Pump Drive | 1 | 417468M1 | A-417468M1 |



MASSEY FERGUSON 187

| Belt No. |  | No. of Belts | OEM  Part No. | PIX  Part No. |
|----------|---|--------------|--|--|
| 1 | Table Feeder Drum | 1 | 1724154M1 | A-1724154M1 |
| 1 | Table Feeder Drum | 1 | 417974M1 | A-417974M1 |
| 2 | Tank Unloader Drive | 1 | 621259M1 | A-621259M1 |
| 3 | Fanning Mill (upper) | 1 | 621261M1 | A-621261M1 |
| 4 | Hydraulic Pump Drive | 1 | 417468M1 | A-417468M1 |
| 5 | Beater / Thresher Control | 1 | 418232M1 | A-418232M1 |
| 6 | Fanning Mill | 1 | 1721710M1 | A-1721710M1 |
| 8 | Traction (upper) | 1 | 905921M1 | A-905921M1 |
| 9 | Traction (lower) | 1 | 905920M1 | A-905920M1 |
| 10 | Reducer | 1 | 417972M1 | A-417972M1 |
| 11 | Auger / Feeder (front) | 1 | 418209M1 | A-418209M1 |
| 12 | Knife - Blade Control | 1 | 1722835M1 | A-1722835M1 |
| 12 | Knife Drive | 1 | 402607M1 | A-402607M1 |
| 15 | Fanning Mill | 1 | 621262M1 | A-621262M1 |
| 16 | Ventilator | 1 | 621262M1 | A-621262M1 |
| 19 | Outlet | 2 | 418192M1 | A-418192M1 |
| 20 | Variator (lower) | 1 | 417995M1 | A-417995M1 |
| 21 | Variator (upper) | 1 | 401109M1 | A-401109M1 |



MASSEY FERGUSON 206

| Belt No. |  | No. of Belts | OEM  Part No. | PIX  Part No. |
|----------|---|--------------|--|--|
| 1 | Table Feeder Drum | 1 | 1724154M1 | A-1724154M1 |
| 2 | Tank Unloader Drive | 1 | 1604055M1 | A-1604055M1 |
| 3 | Fanning Mill (upper) | 1 | 621261M1 | A-621261M1 |
| 5 | Beater / Thresher | 1 | 418232M1 | A-418232M1 |
| 6 | Fanning Mill / Deflector Drum | 1 | 1445437M1 | A-1445437M1 |
| 6 | Fanning Mill | 1 | 1721710M1 | A-1721710M1 |
| 8 | Traction (upper) | 1 | 905921M1 | A-905921M1 |
| 9 | Traction (lower) | 1 | 905920M1 | A-905920M1 |
| 10 | Reducer | 1 | 417972M1 | A-417972M1 |
| 11 | Auger Drive (front) | 1 | 418209M1 | A-418209M1 |
| 12 | Knife - Blade Control | 1 | 1722835M1 | A-1722835M1 |
| 12 | Knife Drive | 1 | 402607M1 | A-402607M1 |
| 13 | Fanning Mill | 1 | 621262M1 | A-621262M1 |
| 14 | Ventilation (secondary) | 1 | 621262M1 | A-621262M1 |
| 15 | Variator (lower) | 1 | 417995M1 | A-417995M1 |
| 16 | Variator (upper) | 1 | 401109M1 | A-401109M1 |



MASSEY FERGUSON 206 OLD

| Belt No. |  | No. of Belts | OEM  Part No. | PIX  Part No. |
|----------|---|--------------|--|--|
| 2 | BEATER - FAN (REAR) | 1 | 621261M1 | A-621261M1 |
| 3 | FANNING MILL | 1 | 621262M1 | A-621262M1 |
| 4 | DRUM DRIVE VARIABLE SPEED | 1 | 905920M1 | A-905920M1 |
| 5 | DRUM DRIVE VARIABLE SPEED | 1 | 905921M1 | A-905921M1 |
| 6 | KNIFE DRIVE (UPPER) | 1 | 417972M1 | A-417972M1 |
| 7 | FEEDER DRIVE | 1 | 1724154M1 | A-1724154M1 |
| 8 | KNIFE DRIVE | 1 | 402607M1 | A-402607M1 |
| 9 | KNIFE DRIVE | 1 | 1722835M1 | A-1722835M1 |
| 10 | TANK UNLOADER DRIVE | 1 | 1604055M1 | A-1604055M1 |
| 11 | BEATER (REAR) | 1 | 418232M1 | A-418232M1 |
| 14 | BEATER CLEANING (REAR) | 1 | 1445437M1 | A-1445437M1 |

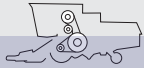

MASSEY FERGUSON 240

| Belt No. |  | No. of Belts | OEM  Part No. | PIX  Part No. |
|----------|---|--------------|--|--|
| 1 | Table Feeder Drum | 1 | 1724154M1 | A-1724154M1 |
| 2 | Tank Unloader Drive | 1 | 1604055M1 | A-1604055M1 |
| 3 | Fanning Mill (upper) | 1 | 621261M1 | A-621261M1 |
| 5 | Beater Drive | 1 | 418232M1 | A-418232M1 |
| 8 | Traction (upper) | 1 | 905921M1 | A-905921M1 |
| 9 | Traction (lower) | 1 | 905920M1 | A-905920M1 |
| 10 | Reducer | 1 | 417972M1 | A-417972M1 |
| 11 | Auger Drive (front) | 1 | 418209M1 | A-418209M1 |
| 12 | Knife Drive | 1 | 1722835M1 | A-1722835M1 |
| 12 | Knife Drive | 1 | 402607M1 | A-402607M1 |
| 12 | Knife Drive | 1 | 410959M1 | A-410959M1 |
| 13 | Reel Drive | 1 | 1604401M1 | A-1604401M1 |
| 15 | Fanning Mill | 1 | 621262M1 | A-621262M1 |



MASSEY FERGUSON 300

| Belt No. |  | No. of Belts | OEM  Part No. | PIX  Part No. |
|----------|---|--------------|--|--|
| 0 | Countershaft - Straw Chopper | 1 | 1033078M1 | A-1033078M1 |
| 0 | Auger (grain) | 1 | 227984M1 | A-227984M1 |
| 0 | Air Conditioning Or Clean Fan High Speed | 1 | 834492M2 | A-834492M2 |
| 1 | Auxiliary Cylinder | 1 | 832822M1 | A-832822M1 |
| 2 | Cleaning Fan Drive | 1 | 832877M1 | A-832877M1 |
| 3 | Cylinder | 1 | 832873M1 | A-832873M1 |
| 4 | Alternator And Waterpump Drive (diesel Engine) | 1 | 236959M1 | A-236959M1 |
| 5 | Reel Drive | 1 | 832872M1 | A-832872M1 |
| 5 | Reel Drive Variable Speed | 1 | 833768M1 | A-833768M1 |
| 5 | Reel Drive | 1 | 834140M1 | A-834140M1 |
| 6 | Return Auger (grain) | 1 | 832866M2 | A-832866M2 |
| 7 | Hydraulic Pump Drive | 1 | 230381M1 | A-230381M1 |
| 8 | Knife Drive | 1 | 834058M1 | A-834058M1 |
| 8 | Knife Drive | 1 | 832869M1 | A-832869M1 |
| 8 | Knife Drive | 1 | 834190M1 | A-834190M1 |
| 9 | Cleaning Fan - (lower) | 1 | 832876M1 | A-832876M1 |
| 10 | Traction (lower) (grain) | 1 | 832789M3 | A-832789M3 |
| 11 | Radiator Fan (gas Engine) | 1 | 236670M1 | A-236670M1 |
| 11 | Radiator Fan (diesel Engine) | 1 | 236958M1 | A-236958M1 |
| 12 | Reel Drive Countershaft | 1 | 834139M1 | A-834139M1 |
| 13 | Rotary Screen - Countershaft (gas Engine) | 1 | 832895M2 | A-832895M2 |
| 14 | Rotary Screen - Countershaft (diesel Engine) | 1 | 832896M1 | A-832896M1 |
| 15 | Rotary Screen Hydraulic Pump - (gas Engine) | 1 | 832867M1 | A-832867M1 |
| 16 | Straw Walker Drive | 1 | 832867M1 | A-832867M1 |
| 17 | Table - Platform | 1 | 228147M91 | A-228147M91 |
| 17 | Table - Platform | 1 | 832870M1 | A-832870M1 |
| 18 | Tank Unloader Drive | 1 | 832878M1 | A-832878M1 |
| 19 | Traction (upper) | 1 | 832790M3 | A-832790M3 |
| 20 | Straw Spreader Drive | 1 | 832855M1 | A-832855M1 |



MASSEY FERGUSON 307

| Belt No. |  | No. of Belts | OEM  Part No. | PIX  Part No. |
|----------|---|--------------|--|--|
| 1 | Table Feeder Drum | 1 | 1724154M1 | A-1724154M1 |
| 2 | Tank Unloader Drive | 1 | 1604055M1 | A-1604055M1 |
| 3 | Fanning Mill (upper) | 1 | 621261M1 | A-621261M1 |
| 4 | Hydraulic Pump Drive | 1 | 1720674M1 | A-1720674M1 |
| 5 | Beater / Thresher | 1 | 1720255M1 | A-1720255M1 |
| 5 | Beater / Thresher | 1 | 1603701M1 | A-1603701M1 |
| 6 | Fanning Mill / Variator | 1 | 621262M1 | A-621262M1 |
| 8 | Traction (lower) | 1 | 905921M1 | A-905921M1 |
| 9 | Traction (upper) | 1 | 905920M1 | A-905920M1 |
| 10 | Control Reducer Up To 8.5 Feet / Bar | 1 | 417972M1 | A-417972M1 |
| 11 | Control Front Auger | 1 | 418209M1 | A-418209M1 |
| 12 | Knife Wobble Drive | 1 | 1722835M1 | A-1722835M1 |
| 12 | Knife Up To 8.5 Feet (2.5 M) | 1 | 402607M1 | A-402607M1 |
| 12 | Knife From 10 Feet (2.2 M) | 1 | 410959M1 | A-410959M1 |
| 13 | Reel Drive | 1 | 1604401M1 | A-1604401M1 |
| 15 | Fanning Mill | 1 | 621262M1 | A-621262M1 |



MASSEY FERGUSON 307 OLD

| Belt No. |  | No. of Belts | OEM  Part No. | PIX  Part No. |
|----------|---|--------------|--|--|
| 2 | Knife Drive (upper) | 1 | 417972M1 | A-417972M1 |
| 3 | Traction Variator Drive | 1 | 905920M1 | A-905920M1 |
| 6 | Traction Variator Drive | 1 | 905921M1 | A-905921M1 |
| 7 | Knife Drive | 1 | 1722835M1 | A-1722835M1 |
| 7 | Knife Drive | 1 | 402607M1 | A-402607M1 |
| 8 | Hydraulic Pump Drive | 1 | 1720647M1 | A-1720647M1 |
| 9 | Beater - Fan (rear) | 1 | 621261M1 | A-621261M1 |
| 10 | Tank Unloader Drive | 1 | 1604055M1 | A-1604055M1 |
| 11 | Feeder Drive | 1 | 1724154M1 | A-1724154M1 |
| 12 | Fan Cleaning | 1 | 621262M1 | A-621262M1 |
| 14 | Beater (rear) | 1 | 418232M1 | A-418232M1 |



MASSEY FERGUSON 400

| Belt No. |  | No. of Belts | OEM  Part No. | PIX  Part No. |
|----------|---|--------------|--|--|
| 1 | Fanning Mill | 1 | 784797M2 | A-784797M2 |
| 2 | Tank Unloader Drive | 1 | 228813M1 | A-228813M1 |
| 3 | Fanning Mill (upper) | 1 | 1855008M1 | A-1855008M1 |
| 5 | Hydraulic Pump Drive | 1 | 832490M1 | A-832490M1 |
| 6 | Alternator Drive | 1 | 893575M1 | A-893575M1 |
| 7 | Drive | 1 | 793863M1 | A-793863M1 |
| 10 | Return Drive | 1 | 795514M4 | A-795514M4 |
| 10 | Return Drive | 1 | 832538M1 | A-832538M1 |
| 11 | Shaker Shaft Drive | 1 | 1615254M1 | A-1615254M1 |
| 11 | Shaker Shaft Drive | 1 | 320593M2 | A-320593M2 |
| 12 | Elevator Drive Grain | 1 | 784796M2 | A-784796M2 |
| 15 | Reducer | 1 | 789853M1 | A-789853M1 |
| 15 | Reducer | 1 | 603719M1 | A-603719M1 |
| 15 | Reducer | 1 | 785806M2 | A-785806M2 |
| 16 | Knife Drive | 1 | 785585M1 | A-785585M1 |
| 17 | Reel Drive | 1 | 1615333M1 | A-1615333M1 |
| 17 | Reel Drive | 1 | 785810M1 | A-785810M1 |



MASSEY FERGUSON 400 - 500

| Belt No. |  | No. of Belts | OEM  Part No. | PIX  Part No. |
|----------|---|--------------|--|--|
| 1 | Radiator Fan Drive | 1 | 228722M1 | A-228722M1 |
| 2 | Radiator Fan Drive | 1 | 233950M1 | A-233950M1 |
| 3 | Hydraulic Pump Drive | 1 | 832490M1 | A-832490M1 |
| 4 | Ventilator | 1 | 227976M1 | A-227976M1 |
| 5 | Beater Drive | 1 | 228999M1 | A-228999M1 |
| 6 | Beater Drive | 1 | 832538M1 | A-832538M1 |
| 7 | Straw Shaker | 1 | 227986M1 | A-227986M1 |
| 8 | Tank Outlet | 1 | 228813M1 | A-228813M1 |
| 9 | Countershaft Drive | 1 | 227457M1 | A-227457M1 |
| 10 | Hopper | 1 | 227984M1 | A-227984M1 |
| 12 | Reel Drive Variable Speed | 1 | 790833M1 | A-790833M1 |
| 13 | After Beater | 1 | 227978M1 | A-227978M1 |



MASSEY FERGUSON 400 - 500 OLD

| Belt No. |  | No. of Belts | OEM  Part No. | PIX  Part No. |
|----------|---|--------------|--|--|
| 2 | Countershaft - Reel Drive | 1 | 1855008M1 | A-1855008M1 |
| 5 | Beater (rear) | 1 | 793863M1 | A-793863M1 |
| 6 | Reel Drive | 1 | 785810M1 | A-785810M1 |
| 7 | Reel Drive Variable Speed | 1 | 785806M1 | A-785806M1 |
| 7 | Reel Drive Variable Speed | 1 | 790833M1 | A-790833M1 |
| 8 | Return Elevator Drive | 1 | 228999M1 | A-228999M1 |
| 8 | Return Elevator Drive | 1 | 832538M1 | A-832538M1 |
| 9 | Radiator Air Intake | 1 | 228722M1 | A-228722M1 |
| 10 | Straw Walker Drive | 1 | 1615254M1 | A-1615254M1 |
| 10 | Straw Walker Drive | 1 | 227986M1 | A-227986M1 |
| 10 | Straw Walker Drive | 1 | 320593M2 | A-320593M2 |
| 12 | Tank Unloader Drive | 1 | 228813M1 | A-228813M1 |
| 15 | Hydraulic Pump Drive | 1 | 230350M1 | A-230350M1 |
| 15 | Hydraulic Pump Drive | 1 | 832490M1 | A-832490M1 |
| 16 | Radiator Fan Drive | 1 | 233950M1 | A-233950M1 |



MASSEY FERGUSON 410 - 415

| Belt No. |  | No. of Belts | OEM  Part No. | PIX  Part No. |
|----------|---|--------------|--|--|
| 1 | FANNING MILL | 1 | 784797M2 | A-784797M2 |
| 2 | TANK UNLOADER DRIVE | 1 | 228813M1 | A-228813M1 |
| 3 | FANNING MILL (UPPER) | 1 | 1855008M1 | A-1855008M1 |
| 5 | HYDRAULIC PUMP DRIVE | 1 | 832490M1 | A-832490M1 |
| 6 | ALTERNATOR DRIVE | 1 | 893575M1 | A-893575M1 |
| 7 | DRIVE | 1 | 793863M1 | A-793863M1 |
| 10 | RETURN DRIVE | 1 | 795514M4 | A-795514M4 |
| 10 | RETURN DRIVE | 1 | 795582M2 | A-795582M2 |
| 11 | SHAKER SHAFT DRIVE | 1 | 1615254M1 | A-1615254M1 |
| 12 | ELEVATOR DRIVE GRAIN | 1 | 784796M2 | A-784796M2 |
| 15 | REDUCER | 1 | 603719M1 | A-603719M1 |
| 16 | KNIFE DRIVE | 1 | 785585M3 | A-785585M3 |
| 17 | REEL DRIVE | 1 | 1615254M1 | A-1615254M1 |
| 17 | REEL DRIVE | 1 | 1615333M1 | A-1615333M1 |



MASSEY FERGUSON 410 - 415 -510 - 515 OLD

| Belt No. |  | No. of Belts | OEM  Part No. | PIX  Part No. |
|----------|---|--------------|--|--|
| 2 | Countershaft - Reel Drive | 1 | 1855008M1 | A-1855008M1 |
| 4 | Main Drive | 1 | 793862M1 | A-793862M1 |
| 5 | Beater (rear) | 1 | 793863M1 | A-793863M1 |
| 6 | Reel Drive | 1 | 1615333M1 | A-1615333M1 |
| 7 | Reel Drive Variable Speed | 1 | 785806M1 | A-785806M1 |
| 7 | Reel Drive Variable Speed | 1 | 790833M1 | A-790833M1 |
| 8 | Return Elevator Drive | 1 | 795514M4 | A-795514M4 |
| 8 | Return Elevator Drive | 1 | 795582M1 | A-795582M1 |
| 9 | Radiator Air Intake | 1 | 228722M1 | A-228722M1 |
| 10 | Straw Walker Drive | 1 | 1615254M1 | A-1615254M1 |
| 12 | Tank Unloader Drive | 1 | 228813M1 | A-228813M1 |
| 15 | Hydraulic Pump Drive | 1 | 230350M1 | A-230350M1 |
| 15 | Hydraulic Pump Drive | 1 | 832490M1 | A-832490M1 |
| 16 | Radiator Fan Drive | 1 | 233950M1 | A-233950M1 |
| 17 | Knife Drive | 1 | 785585M3 | A-785585M3 |

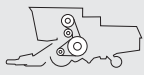

MASSEY FERGUSON 410 - 415

| Belt No. |  | No. of Belts | OEM  Part No. | PIX  Part No. |
|----------|---|--------------|--|--|
| 1 | Engine Fan Drive | 1 | 240575M2 | A-784797M2 |
| 2 | Hydraulic Pump Drive | 1 | 832490M1 | A-228813M1 |
| 3 | Air Filter | 1 | 228722M1 | A-1855008M1 |
| 4 | Ventilator | 1 | 227976M1 | A-832490M1 |
| 6 | Hydraulic Pump Drive | 1 | 230381M1 | A-893575M1 |
| 7 | Tank Outlet | 1 | 228813M1 | A-793863M1 |
| 8 | Ventilator | 1 | 227457M1 | A-795514M4 |
| 9 | Hopper | 1 | 227984M1 | A-795582M2 |
| 10 | Reel Drive | 1 | 1615333M1 | A-1615254M1 |
| 11 | Return Elevator Drive | 1 | 796487M1 | A-784796M2 |
| 13 | Reel Drive Variable Speed | 1 | 785806M1 | A-603719M1 |
| 14 | Reel Drive Variable Speed | 1 | 790833M1 | A-785585M3 |
| 15 | Main Transmission | 1 | 230356M2 | A-1615254M1 |
| 16 | Main Transmission | 1 | 233213M2 | A-1615333M1 |



MASSEY FERGUSON 440

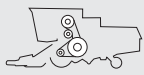

| Belt No. |  | No. of Belts | OEM  Part No. | PIX  Part No. |
|----------|---|--------------|--|--|
| 1 | Table Feeder Drum | 1 | 621588M1 | A-621588M1 |
| 2 | Tank Unloader Drive | 1 | 1604055M1 | A-1604055M1 |
| 3 | Fanning Mill (upper) | 1 | 621261M1 | A-621261M1 |
| 5 | Beater Drive | 1 | 1720255M1 | A-1720255M1 |
| 8 | Traction (upper) | 1 | 905921M1 | A-905921M1 |
| 9 | Traction (lower) | 1 | 905920M1 | A-905920M1 |
| 12 | Knife Drive | 1 | 410959M1 | A-410959M1 |
| 13 | Reel Drive | 1 | 1604401M1 | A-1604401M1 |
| 15 | Fanning Mill | 1 | 621262M1 | A-621262M1 |

MASSEY FERGUSON 487 - 506 - 507

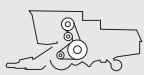

| Belt No. |  | No. of Belts | OEM  Part No. | PIX  Part No. |
|----------|---|--------------|--|--|
| 1 | Table Feeder Drum | 1 | 621588M1 | A-621588M1 |
| 2 | Tank Unloader Drive | 1 | 905980M1 | A-905980M1 |
| 3 | Fanning Mill (upper) | 1 | 621261M1 | A-621261M1 |
| 4 | Hydraulic Pump Drive | 1 | 1720674M1 | A-1720674M1 |
| 5 | Beater Drive | 1 | 1720255M1 | A-1720255M1 |
| 9 | Traction (lower) | 1 | 905982M1 | A-905982M1 |
| 10 | Reducer | 1 | 417972M1 | A-417972M1 |
| 11 | Auger Drive (front) | 1 | 418209M1 | A-418209M1 |
| 12 | Knife Drive | 1 | 402607M1 | A-402607M1 |
| 12 | Knife Drive | 1 | 410959M1 | A-410959M1 |
| 15 | Fanning Mill | 1 | 621262M1 | A-621262M1 |

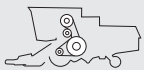
MASSEY FERGUSON 487



| Belt No. |  | No. of Belts | OEM  Part No. | PIX  Part No. |
|----------|---|--------------|--|--|
| 2 | Ventilator | 1 | 621262M1 | A-621262M1 |
| 5 | Deflector Drum | 1 | 1720255M1 | A-1720255M1 |
| 6 | Outlet Grain | 2 | 418192M1 | A-418192M1 |
| 7 | Bar Control | 1 | 621588M1 | A-621588M1 |
| 8 | Hydraulic Pump Drive | 1 | 1720674M1 | A-1720674M1 |

| Belt No. |  | No. of Belts | OEM  Part No. | PIX  Part No. |
|----------|---|--------------|--|--|
| 2 | Beater - Fan (rear) | 1 | 621261M1 | A-621261M1 |
| 6 | Knife Drive (upper) | 1 | 417972M1 | A-417972M1 |
| 7 | Feeder Drive | 1 | 1720488M1 | A-1720488M1 |
| 8 | Knife Drive | 1 | 402607M1 | A-402607M1 |
| 9 | Feeder Auger | 1 | 1722835M1 | A-1722835M1 |
| 10 | Tank Unloader Drive | 1 | 621259M1 | A-621259M1 |
| 11 | Beater (rear) | 1 | 1720255M1 | A-1720255M1 |
| 13 | Hydraulic Pump Drive | 1 | 1720674M2 | A-1720674M2 |



MASSEY FERGUSON 500

| Belt No. |  | No. of Belts | OEM  Part No. | PIX  Part No. |
|----------|---|--------------|--|--|
| 1 | Fanning Mill | 1 | 784797M2 | A-784797M2 |
| 2 | Tank Unloader Drive | 1 | 228113M1 | A-228113M1 |
| 3 | Fanning Mill (upper) | 1 | 1855008M1 | A-1855008M1 |
| 5 | Hydraulic Pump Drive | 1 | 230381M1 | A-230381M1 |
| 6 | Alternator Drive | 1 | 893575M1 | A-893575M1 |
| 7 | Drive | 1 | 793863M1 | A-793863M1 |
| 8 | Main Belt | 1 | 793862M1 | A-793862M1 |
| 10 | Return Drive | 1 | 228999M1 | A-228999M1 |
| 10 | Return Drive | 1 | 832538M1 | A-832538M1 |
| 11 | Shaker Shaft Drive | 1 | 320593M2 | A-320593M2 |
| 12 | Elevator Drive Grain | 1 | 784796M2 | A-784796M2 |
| 15 | Reducer | 1 | 603719M1 | A-603719M1 |
| 15 | Reducer | 1 | 790833M1 | A-790833M1 |

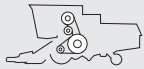

MASSEY FERGUSON 506 OLD

| Belt No. |  | No. of Belts | OEM  Part No. | PIX  Part No. |
|----------|---|--------------|--|--|
| 2 | Beater - Fan (Rear) | 1 | 621261M1 | A-621261M1 |
| 3 | Fanning Mill | 1 | 621262M1 | A-621262M1 |
| 6 | Knife Drive (Upper) | 1 | 417972M1 | A-417972M1 |
| 7 | Feeder Drive | 1 | 621588M1 | A-621588M1 |
| 8 | Knife Drive | 1 | 402607M1 | A-402607M1 |
| 9 | Feeder Auger | 1 | 410959M1 | A-410959M1 |
| 10 | Tank Unloader Drive | 1 | 905980M1 | A-905980M1 |
| 11 | Beater (Rear) | 1 | 1720255M1 | A-1720255M1 |
| 13 | Hydraulic Pump Drive | 1 | 1720674M1 | A-1720674M1 |

MASSEY FERGUSON 507

| Belt No. |  | No. of Belts | OEM  Part No. | PIX  Part No. |
|----------|---|--------------|--|--|
| 2 | Ventilator | 1 | 621262M1 | A-621262M1 |
| 3 | Ventilator | 1 | 621261M1 | A-621261M1 |
| 5 | Outlet Grain | 1 | 905980M1 | A-905980M1 |
| 6 | Deflector Drum | 1 | 1720205M3 | A-1720205M3 |
| 7 | Blade Control | 1 | 410959M1 | A-410959M1 |
| 8 | Bar Control | 1 | 621588M1 | A-621588M1 |
| 9 | Hydraulic Pump Drive | 1 | 1720674M2 | A-1720674M2 |

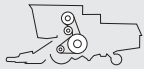
MASSEY FERGUSON 507 OLD

| Belt No. |  | No. of Belts | OEM  Part No. | PIX  Part No. |
|----------|---|--------------|--|--|
| 2 | Traction Variator Drive | 1 | 905981M1 | A-905981M1 |
| 3 | Traction Variator Drive | 1 | 905982M1 | A-905982M1 |
| 4 | Beater (rear) | 1 | 1720205M3 | A-1720205M3 |
| 6 | Beater (rear) | 1 | 621261M1 | A-621261M1 |
| 7 | Fanning Mill | 1 | 621262M1 | A-621262M1 |
| 8 | Feeder Drive | 1 | 621588M1 | A-621588M1 |
| 9 | Tank Unloader Drive | 1 | 905980M1 | A-905980M1 |
| 10 | Hydraulic Pump Drive | 1 | 1720674M2 | A-1720674M2 |
| 13 | Knife Drive | 1 | 410959M1 | A-410959M1 |

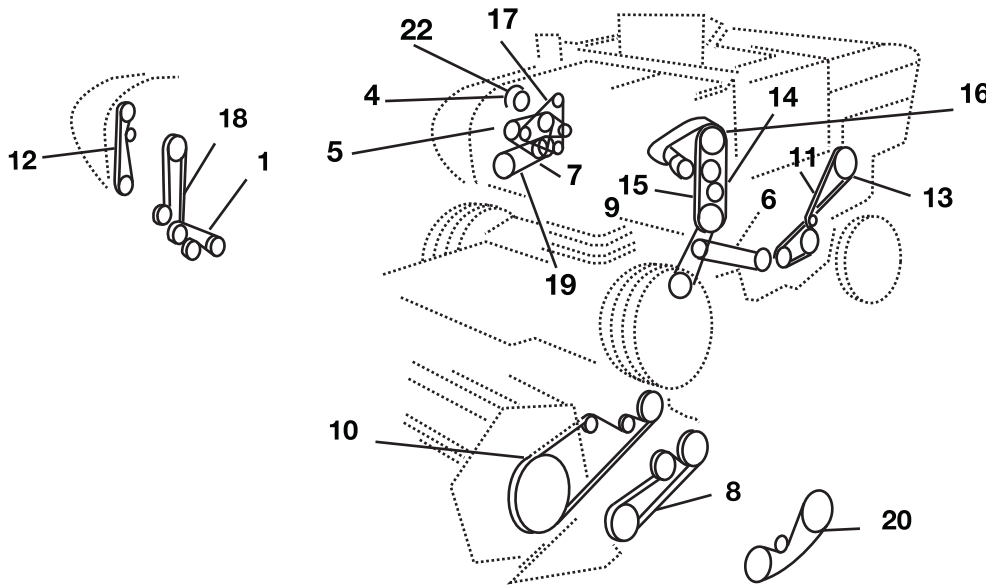

VARIABLE REEL DRIVE



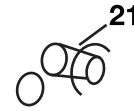

VARIABLE SPEED REEL



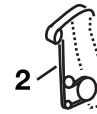

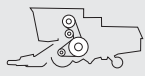
RETHRESHER SLINCER







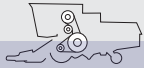

| Belt No. |  | No. of Belts | OEM Part No.  | PIX Part No.  |
|----------|---|--------------|--|--|
| 1 | Fanning Mill | 1 | 784797M2 | A-784797M2 |
| 2 | Tank Unloader Drive | 1 | 228813M1 | A-228813M1 |
| 3 | Fanning Mill (upper) | 1 | 1855008M1 | A-1855008M1 |
| 5 | Hydraulic Pump Drive | 1 | 230381M1 | A-230381M1 |
| 6 | Alternator Drive | 1 | 893575M1 | A-893575M1 |
| 7 | Drive | 1 | 793863M1 | A-793863M1 |
| 8 | Main Belt | 1 | 793862M1 | A-793862M1 |
| 10 | Return Drive | 1 | 795514M4 | A-795514M4 |
| 10 | Return Drive | 1 | 795582M2 | A-795582M2 |
| 11 | Shaker Shaft Drive | 1 | 1615254M1 | A-1615254M1 |
| 12 | Elevator Drive Grain | 1 | 784796M2 | A-784796M2 |
| 15 | Reducer | 1 | 603719M1 | A-603719M1 |
| 16 | Knife Drive | 1 | 785585M3 | A-785585M3 |
| 17 | Reel Drive | 1 | 1615254M1 | A-1615254M1 |
| 17 | Reel Drive | 1 | 1615333M1 | A-1615333M1 |

MASSEY FERGUSON 520 - 525



| Belt No. |  | No. of Belts | OEM  Part No. | PIX  Part No. |
|----------|---|--------------|--|--|
| 2 | DRUM DRIVE | 1 | 912877M1 | A-912877M1 |
| 3 | DRIVE RIGHT SIDE | 1 | 227976M1 | A-227976M1 |
| 5 | RETURN ELEVATOR DRIVE | 1 | 795582M1 | A-795582M1 |
| 7 | THRESHING DRIVE | 1 | 619327M1 | A-619327M1 |
| 8 | HYDRAULIC PUMP DRIVE | 1 | 619595M1 | A-619595M1 |
| 9 | OUTLET | 1 | 619317M1 | A-619317M1 |
| 11 | BLADE DRIVE | 1 | 785585M1 | A-785585M1 |
| 12 | AUGER DRIVE | 1 | 227984M1 | A-227984M1 |
| 13 | REEL DRIVE | 1 | 796487M1 | A-796487M1 |
| 14 | STRAW SHAKER | 1 | 796487M1 | A-796487M1 |
| 15 | REEL DRIVE VARIABLE SPEED | 1 | 789853M1 | A-789853M1 |

MASSEY FERGUSON 520

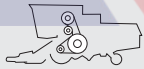

| Belt No. |  | No. of Belts | OEM  Part No. | PIX  Part No. |
|----------|---|--------------|--|--|
| 1 | FANNING MILL | 1 | 1616477M1 | A-1616477M1 |
| 1 | FANNING MILL | 1 | 784797M2 | A-784797M2 |
| 2 | TANK UNLOADER DRIVE | 1 | 619317M2 | A-619317M2 |
| 3 | FANNING MILL (UPPER) | 1 | 785585M3 | A-785585M3 |
| 3 | FANNING MILL (UPPER) | 1 | 789853M1 | A-789853M1 |
| 5 | HYDRAULIC PUMP DRIVE | 1 | 782849M2 | A-782849M2 |
| 6 | ALTERNATOR DRIVE | 1 | 1446201M1 | A-1446201M1 |
| 6 | ALTERNATOR DRIVE | 1 | 1604524M1 | A-1604524M1 |
| 6 | ALTERNATOR DRIVE | 1 | 2614A158 | A-2614A158 |
| 6 | ALTERNATOR DRIVE | 1 | 893575M1 | A-893575M1 |
| 7 | DRIVE | 1 | 789967M1 | A-789967M1 |
| 8 | MAIN BELT | 1 | 789930M1 | A-789930M1 |
| 9 | MULTI FLOW | 1 | 784170M2 | A-784170M2 |
| 10 | RETURN DRIVE | 1 | 795514M4 | A-795514M4 |
| 10 | RETURN DRIVE | 1 | 795582M2 | A-795582M2 |
| 11 | SHAKER SHAFT DRIVE | 1 | 1615254M1 | A-1615254M1 |
| 12 | ELEVATOR DRIVE GRAIN | 1 | 784796M2 | A-784796M2 |
| 15 | REDUCER | 1 | 789853M1 | A-789853M1 |
| 16 | KNIFE DRIVE | 1 | 785585M3 | A-785585M3 |
| 17 | REEL DRIVE | 1 | 1615333M1 | A-1615333M1 |
| 17 | REEL DRIVE | 1 | 785810M1 | A-785810M1 |

| Belt No. |  | No. of Belts | OEM  Part No. | PIX  Part No. |
|----------|---|--------------|--|--|
| 1 | FANNING MILL | 1 | 1616477M1 | A-1616477M1 |
| 1 | FANNING MILL | 1 | 784797M2 | A-784797M2 |
| 2 | TANK UNLOADER | 1 | 619317M2 | A-619317M2 |
| 3 | FANNING MILL UPPER | 1 | 785585M3 | A-785585M3 |
| 3 | FANNING MILL UPPER | 1 | 789853M1 | A-789853M1 |
| 5 | HYDRAULIC PUMP | 1 | 782849M2 | A-782849M2 |
| 6 | GENERATOR | 1 | 1446201M1 | A-1446201M1 |
| 6 | GENERATOR | 1 | 1604524M1 | A-1604524M1 |
| 6 | GENERATOR | 1 | 2614A158 | A-2614A158 |
| 6 | GENERATOR | 1 | 893575M1 | A-893575M1 |
| 7 | DRIVE | 1 | 789967M1 | A-789967M1 |
| 8 | MAIN BELT | 1 | 789930M1 | A-789930M1 |
| 9 | MULTI FLOW | 1 | 784170M2 | A-784170M2 |
| 10 | RETURNS | 1 | 795514M4 | A-795514M4 |
| 10 | RETURNS | 1 | 795582M2 | A-795582M2 |
| 11 | SHAKER | 1 | 1615254M1 | A-1615254M1 |
| 12 | GRAIN ELEVATOR | 1 | 784796M2 | A-784796M2 |
| 15 | REDUCER | 1 | 789853M1 | A-789853M1 |
| 16 | KNIFE | 1 | 785585M3 | A-785585M3 |
| 17 | REEL | 1 | 1615333M1 | A-1615333M1 |
| 17 | REEL | 1 | 785810M1 | A-785810M1 |

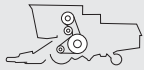

MASSEY FERGUSON 520 - 525 - 620 - 625 OLD

| Belt No. |  | No. of Belts | OEM  Part No. | PIX  Part No. |
|----------|---|--------------|--|--|
| 1 | TANK UNLOADING | 1 | 619317M2 | A-619317M2 |
| 2 | TRACTION VARI-DRIVE | 1 | 1615715M1 | A-1615715M1 |
| 3 | HYDRAULIC PUMP | 1 | 782849M2 | A-782849M2 |
| 3 | HYDRAULIC PUMP | 1 | 782850M2 | A-782850M2 |
| 5 | CASCADE SEPARATOR | 1 | 784170M2 | A-784170M2 |
| 6 | 2ND COUNTERSHAFT - GRAIN AUGER | 1 | 784796M2 | A-784796M2 |
| 7 | 2ND COUNTERSHAFT - FAN | 1 | 784797M2 | A-784797M2 |
| 8 | KNIFE DRIVE | 1 | 785585M3 | A-785585M3 |
| 9 | 2ND COUNTERSHAFT DRIVE | 1 | 785585M3 | A-785585M3 |
| 10 | REEL VARI-DRIVE | 1 | 789853M1 | A-789853M1 |
| 11 | PICK-UP REEL | 1 | 1615333M1 | A-1615333M1 |
| 11 | REEL DRIVE | 1 | 785810M1 | A-785810M1 |
| 12 | REAR BEATER | 1 | 789967M1 | A-789967M1 |
| 13 | RETURNS ELEVATOR | 1 | 795514M4 | A-795514M4 |
| 13 | RETURNS ELEVATOR | 1 | 795582M2 | A-795582M2 |
| 14 | STRAW WALKER | 1 | 1615254M1 | A-1615254M1 |
| 17 | MAIN DRIVE | 1 | 789930M1 | A-789930M1 |
| 17 | MAIN DRIVE | 1 | 789931M1 | A-789931M1 |

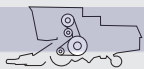

MASSEY FERGUSON 530 - 535

| Belt No. |  | No. of Belts | OEM  Part No. | PIX  Part No. |
|----------|---|--------------|--|--|
| 1 | FANNING MILL | 1 | 784797M2 | A-784797M2 |
| 2 | TANK UNLOADER | 1 | 3370141M1 | A-3370141M1 |
| 3 | FANNING MILL UPPER | 1 | 785585M3 | A-785585M3 |
| 8 | MAIN BELT | 1 | 789930M1 | A-789930M1 |
| 9 | MULTI FLOW | 1 | 795582M2 | A-795582M2 |
| 10 | RETURN | 1 | 795514M4 | A-795514M4 |
| 11 | SHAKER | 1 | 1615254M1 | A-1615254M1 |
| 12 | GRAIN ELEVATOR | 1 | 784796M2 | A-784796M2 |
| 16 | KNIFE | 1 | 1724154M1 | A-1724154M1 |
| 17 | REEL | 1 | 843313M1 | A-843313M1 |

MASSEY FERGUSON 530S - 560 - 565 - 660 - 665

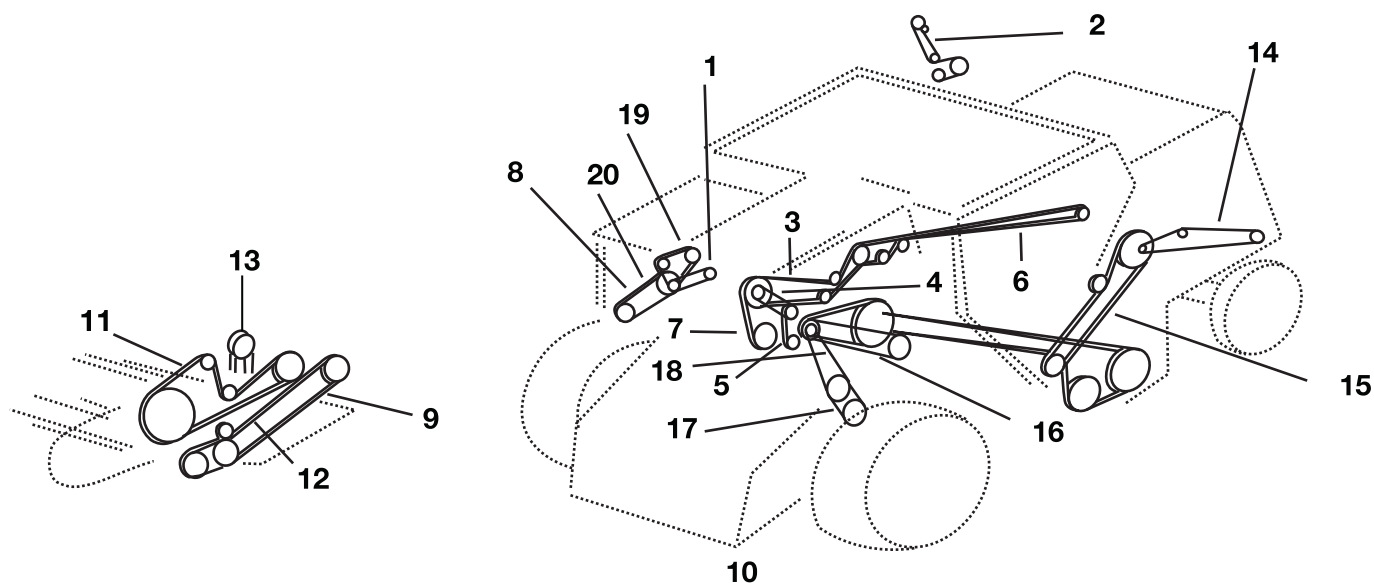

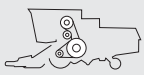
| Belt No. |  | No. of Belts | OEM  Part No. | PIX  Part No. |
|----------|--|--------------|--|--|
| 1 | FANNING MILL | 1 | 3043154M1 | A-3043154M1 |
| 1 | FANNING MILL | 1 | 3043153M1 | A-3043153M1 |
| 2 | TANK UNLOADER | 1 | 3370141M1 | A-3370141M1 |
| 3 | FANNING MILL UPPER | 1 | 785585M3 | A-785585M3 |
| 5 | HYDRAULIC PUMP | 1 | 843313M1 | A-843313M1 |
| 6 | GENERATOR | 1 | 1687531M1 | A-1687531M1 |
| 7 | DRIVE | 1 | 789967M1 | A-789967M1 |
| 8 | MAIN BELT | 1 | 789930M1 | A-789930M1 |
| 8 | MAIN BELT | 1 | 789931M1 | A-789931M1 |
| 10 | RETURN | 1 | 795514M4 | A-795514M4 |
| 10 | RETURN | 1 | 795582M2 | A-795582M2 |
| 11 | SHAKER | 1 | 1615254M1 | A-1615254M1 |
| 12 | GRAIN ELEVATOR | 1 | 784796M2 | A-784796M2 |
| 14 | TRACTION LOWER | 1 | 232511M2 | A-232511M2 |
| 15 | REDUCER | 1 | 789853M1 | A-789853M1 |
| 16 | KNIFE | 1 | 1724154M1 | A-1724154M1 |
| 17 | REEL | 1 | 843313M1 | A-843313M1 |



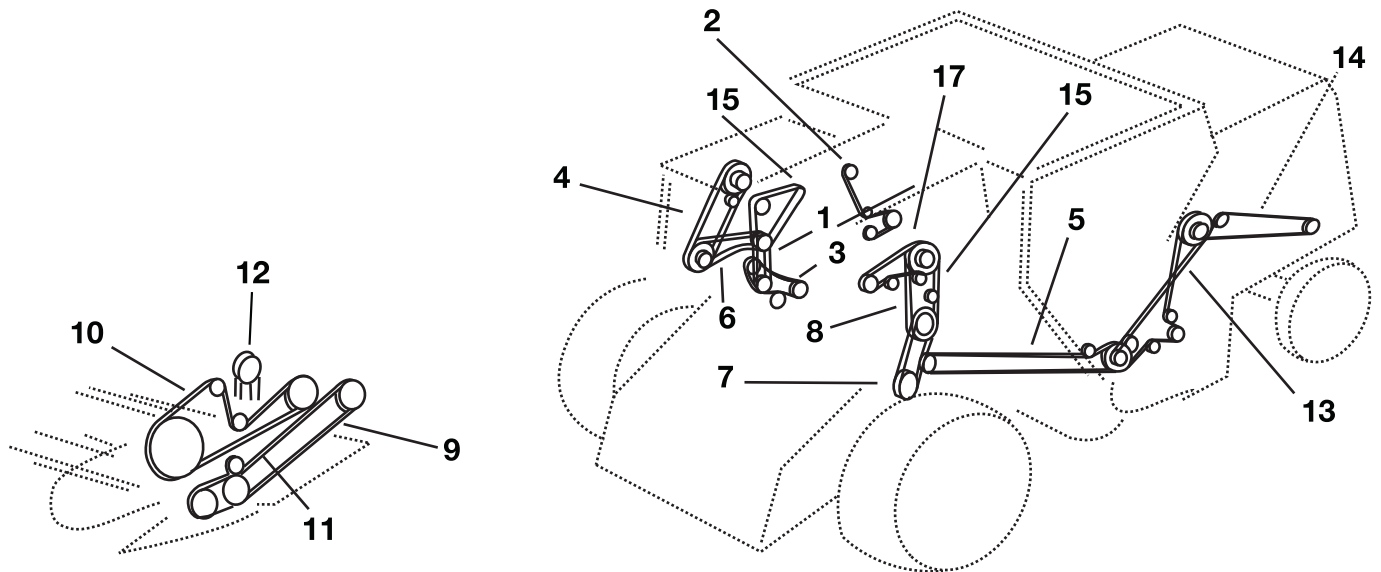

| Belt No. |  | No. of Belts | OEM  Part No. | PIX  Part No. |
|----------|---|--------------|--|--|
| 0 | Pick Up Drive | 1 | 1047702M1 | A-1047702M1 |
| 1 | Air Conditioning Compressor Drive | 1 | 843045M1 | A-843045M1 |
| 2 | Auxiliary Cylinder (slinger) | 1 | 834332M1 | A-834332M1 |
| 3 | Chopper Drive - High Speed | 1 | 843760M1 | A-843760M1 |
| 3 | Chopper Drive - Low Speed | 1 | 843759M1 | A-843759M1 |
| 4 | Cleaning Fan Drive | 1 | 832877M1 | A-832877M1 |
| 5 | Cleaning Fan - Countershaft | 1 | 228997M1 | A-228997M1 |
| 6 | Countershaft Drive | 1 | 843758M1 | A-843758M1 |
| 7 | Cylinder | 1 | 832873M1 | A-832873M1 |
| 8 | Air Intake Drive | 1 | 240575M2 | A-240575M2 |
| 9 | Knife Wobble- 13 Rigid Bar High Speed | 1 | 832085M1 | A-832085M1 |
| 9 | Knife Wobble- Floating Cut Bar | 1 | 833962M1 | A-833962M1 |
| 9 | Knife Wobble- Rigid Cutbar | 1 | 834190M1 | A-834190M1 |
| 9 | Knife Wobble- Speed Up 15.16.18.20 | 1 | 843029M1 | A-843029M1 |
| 10 | Beater (rear)or Straw Chopper | 1 | 843747M1 | A-843747M1 |
| 11 | Reel Drive | 1 | 834140M1 | A-834140M1 |
| 12 | Reel Drive Countershaft | 1 | 834139M1 | A-834139M1 |
| 13 | Reel Drive Variable Speed | 1 | 833768M1 | A-833768M1 |
| 14 | Straw Spreader Drive | 1 | 843742M1 | A-843742M1 |
| 15 | Straw Walker Drive | 1 | 832867M1 | A-832867M1 |
| 16 | Tank Unloader Drive | 1 | 832878M1 | A-832878M1 |
| 17 | Traction (lower) | 1 | 843732M2 | A-843732M2 |
| 18 | Traction (upper) | 1 | 832790M3 | A-832790M3 |
| 18 | Traction (upper) | 1 | 844091M1 | A-844091M1 |
| 19 | Alternator, Fanand Waterpump Drive | 1 | 532779M92 | A-532779M92 |
| 19 | Alternator, Fanand Waterpump Drive | 1 | 844171M1 | A-844171M1 |
| 20 | Hydraulic Pump Drive | 1 | 230380M1 | A-230380M1 |



MASSEY FERGUSON 550





| Belt No. |  | No. of Belts | OEM  Part No. | PIX  Part No. |
|----------|---|--------------|--|--|
| 0 | PICK UP DRIVE | 1 | 1047702M1 | A-1047702M1 |
| 0 | CHOPPER DRIVE | 1 | 1051235M1 | A-1051235M1 |
| 0 | STRAW CHOPPER CORN KIT - LOW SPEED | 1 | 842935M1 | A-842935M1 |
| 1 | CLEANING FAN- COUNTERSHAFT | 1 | 227457M1 | A-227457M1 |
| 2 | AUXILIARY CYLINDER (SLINGER) | 1 | 834332M1 | A-834332M1 |
| 3 | CLEANING FAN DRIVE | 1 | 227976M1 | A-227976M1 |
| 3 | CLEANING FAN- HIGH SPEED | 1 | 834492M2 | A-834492M2 |
| 5 | AUGER (GRAIN) | 1 | 227984M1 | A-227984M1 |
| 6 | HYDRAULIC PUMP DRIVE | 1 | 843737M1 | A-843737M1 |
| 7 | TRACTION (LOWER) - 4 SPEED | 1 | 230097M2 | A-230097M2 |
| 7 | HYDROSTATIC DRIVE (LOWER) | 1 | 834176M1 | A-834176M1 |
| 8 | HYDROSTATIC DRIVE (UPPER) | 1 | 834175M1 | A-834175M1 |
| 9 | KNIFE WOBBLE - CENTERED CHAIN DRIVE | 1 | 834058M1 | A-834058M1 |
| 9 | KNIFE WOBBLE - RIGID CUT BAR | 1 | 195671M1 | A-195671M1 |
| 9 | KNIFE WOBBLE - FLOATING CUT BAR | 1 | 833962M1 | A-833962M1 |
| 9 | KNIFE WOBBLE - RIGID CUT BAR | 1 | 834190M1 | A-834190M1 |
| 10 | REEL DRIVE | 1 | 834140M1 | A-834140M1 |
| 11 | REEL DRIVE COUNTERSHAFT | 1 | 834139M1 | A-834139M1 |
| 12 | REEL DRIVE VARIABLE SPEED | 1 | 833768M1 | A-833768M1 |
| 13 | RETURN AUGER AND WALKER | 1 | 227986M2 | A-227986M2 |
| 14 | STRAW SPREADER (DUAL) | 1 | 834254M1 | A-834254M1 |
| 15 | TANK UNLOADER DRIVE | 1 | 228813M3 | A-228813M3 |
| 16 | ALTERNATOR, FAN AND WATERPUMP DRIVE | 1 | 268847M91 | A-268847M91 |
| 16 | ALTERNATOR, FAN AND WATERPUMP DRIVE | 1 | 532779M92 | A-532779M92 |

| Belt No. |  | No. of Belts | OEM  Part No. | PIX  Part No. |
|----------|---|--------------|--|--|
| 2 | Return Elevator Drive | 1 | 795582M1 | A-795582M1 |
| 4 | Reel Drive | 1 | 785810M1 | A-785810M1 |
| 5 | Outlet | 1 | 619317M1 | A-619317M1 |
| 6 | Blade Drive | 1 | 785585M1 | A-785585M1 |
| 7 | Supplementary Drive | 1 | 785585M1 | A-785585M1 |
| 9 | Reel Drive | 1 | 1615333M1 | A-1615333M1 |
| 10 | Straw Shaker | 1 | 796487M1 | A-796487M1 |
| 11 | Reel Drive Variable Speed | 1 | 789853M1 | A-789853M1 |
| 12 | Threshing Drive | 1 | 789931M1 | A-789931M1 |
| 13 | Drum Drive | 1 | 789967M1 | A-789967M1 |

MASSEY FERGUSON 630 OLD - 630S OLD

| Belt No. |  | No. of Belts | OEM  Part No. | PIX  Part No. |
|----------|---|--------------|--|--|
| 1 | Tank Unloader Drive | 1 | 324872M1 | A-324872M1 |
| 3 | Fanning Mill | 1 | 321034M3 | A-321034M3 |
| 4 | Table Drive | 1 | 320595M2 | A-320595M2 |
| 4 | Table Drive | 1 | 322768M1 | A-322768M1 |
| 5 | Cylinder | 1 | 320496M3 | A-320496M3 |
| 6 | Knife Drive | 1 | 320623M2 | A-320623M2 |
| 7 | Feeder Auger | 1 | 320596M1 | A-320596M1 |
| 8 | Traction Variator Drive | 1 | 320551M1 | A-320551M1 |
| 9 | Hydraulic Pump Drive | 1 | 410195M1 | A-410195M1 |
| 10 | Straw Walker Drive | 1 | 320593M2 | A-320593M2 |



MASSEY FERGUSON 685 OLD - 685S OLD

| Belt No. |  | No. of Belts | OEM  Part No. | PIX  Part No. |
|----------|---|--------------|--|--|
| 1 | KNIFE DRIVE | 1 | 402607M1 | A-402607M1 |
| 2 | TRACTION VARIATOR DRIVE | 1 | 401110M1 | A-401110M1 |
| 3 | CYLINDER | 1 | 402608M3 | A-402608M3 |
| 4 | COUNTERSHAFT DRIVE | 1 | 402603M1 | A-402603M1 |
| 5 | TRACTION VARIATOR DRIVE | 1 | 401109M1 | A-401109M1 |
| 7 | HYDRAULIC PUMP DRIVE (PERKINS) | 1 | 403041M1 | A-403041M1 |
| 8 | RADIATOR FAN DRIVE | 1 | 402177M1 | A-402177M1 |
| 9 | TANK UNLOADER DRIVE | 1 | 403071M1 | A-403071M1 |
| 10 | STRAW BALER | 1 | 328656M1 | A-328656M1 |
| 11 | FANNING MILL | 1 | 402604M1 | A-402604M1 |
| 12 | FANNING MILL | 1 | 402605M1 | A-402605M1 |
| 13 | BEATER (REAR) | 1 | 402606M1 | A-402606M1 |



MASSEY FERGUSON 750 - 755

| Belt No. |  | No. of Belts | OEM  Part No. | PIX  Part No. |
|----------|---|--------------|--|--|
| 1 | Hydraulic Pump Drive (mechanical Serial Nr. 5387 -) | 1 | 222882M2 | A-222882M2 |
| 1 | Hydraulic Pump Drive | 1 | 842413M1 | A-842413M1 |
| 2 | Radiator Fan (mechanical Serial Nr. 1979-5387) | 1 | 259047M91 | A-259047M91 |
| 2 | Radiator Fan Drive | 2 | 265522M91 | A-265522M91 |
| 3 | Alternator Drive | 1 | 844079M1 | A-844079M1 |
| 4 | Air Conditioning Compressor Drive | 1 | 1686883M1 | A-1686883M1 |
| 4 | Air Conditioning Compressor Drive (serial Nr. 9674 -) | 1 | 834492M2 | A-834492M2 |
| 4 | Air Conditioning Compressor Drive (serial Nr. 9674 -) | 1 | 843045M1 | A-843045M1 |
| 5 | Main Drive | 1 | 833874M1 | A-833874M1 |
| 6 | Air Intake Drive | 1 | 216897M1 | A-216897M1 |
| 7 | Return Elevator Drive | 1 | 833854M2 | A-833854M2 |
| 8 | Cylinder | 1 | 833868M2 | A-833868M2 |
| 9 | Hydrostatic Reel Drive | 1 | 842845M1 | A-842845M1 |
| 10 | Straw Chopper (serial Nr. ... - 16539) | 1 | 833871M1 | A-833871M1 |
| 10 | Straw Chopper (serial Nr. 16539 - ...) | 1 | 843948M1 | A-843948M1 |
| 11 | Straw Chopper Drive | 1 | 3172001M1 | A-3172001M1 |
| 11 | Straw Chopper (serial Nr. ... - 16539) | 1 | 832866M2 | A-832866M2 |
| 11 | Straw Chopper (serial Nr. 16539 - ...) | 1 | 843747M1 | A-843747M1 |
| 12 | Straw Chopper Drive | 1 | 843760M1 | A-843760M1 |
| 12 | Straw Chopper Drive (serial Nr. 16539 - ...) | 1 | 832906M1 | A-832906M1 |
| 12 | Straw Chopper Drive (serial Nr. ... - 16539) | 1 | 833872M1 | A-833872M1 |
| 13 | Straw Spreader Drive | 1 | 842110M1 | A-842110M1 |
| 14 | Straw Walker Drive | 1 | 843310M1 | A-843310M1 |
| 14 | Straw Walker Drive | 1 | 833855M1 | A-833855M1 |
| 15 | Shaker Shoe Drive | 2 | 273757M91 | A-273757M91 |
| 16 | Shaker Shoe - Counter shaft - Fan (serial Nr. - 15716) | 1 | 274015M91 | A-274015M91 |
| 16 | Shaker Shoe - Counter shaft - Fan (serial Nr. 15716 -) | 2 | 281560M91 | A-281560M91 |
| 17 | Cleaning Fan drive | 1 | 833863M1 | A-833863M1 |
| 17 | Cleaning Fan- Small Seed Kit | 1 | 842423M1 | A-842423M1 |
| 18 | Traction (upper) | 1 | 833856M1 | A-833856M1 |
| 18 | Traction (upper) | 1 | 833857M4 | A-833857M4 |
| 18 | Traction (upper) | 1 | 833858M4 | A-833858M4 |
| 18 | Hydrostatic Traction Drive (upper) | 1 | 844077M1 | A-844077M1 |
| 19 | Traction (lower) | 1 | 833858M4 | A-833858M4 |
| 19 | Traction (lower) | 1 | 833866M1 | A-833866M1 |
| 20 | Reel Drive | 1 | 834140M1 | A-834140M1 |
| 21 | Reel Drive Variable Speed | 1 | 833768M1 | A-833768M1 |
| 22 | Knife Wobble Drive | 1 | 834190M1 | A-834190M1 |
| 22 | Wobble Box Drive | 1 | 842809M1 | A-842809M1 |
| 23 | Reel Drive Counter shaft | 1 | 834139M1 | A-834139M1 |
| 24 | Discharge Drive Grain Tank | 1 | 833873M1 | A-833873M1 |



MASSEY FERGUSON 750 OLD

| Belt No. |  | No. of Belts | OEM  Part No. | PIX  Part No. |
|----------|---|--------------|--|--|
| 1 | - | 1 | 834140M1 | A-834140M1 |
| 2 | Reel Drive Variable Speed | 1 | 833768M1 | A-833768M1 |
| 3 | Reel Drive | 1 | 834139M1 | A-834139M1 |
| 4 | Wobble Box Drive | 1 | 834058M1 | A-834058M1 |
| 4 | Wobble Box Drive | 1 | 842809M1 | A-842809M1 |
| 5 | Traction Drive | 1 | 833856M1 | A-833856M1 |
| 6 | Traction Drive | 1 | 833859M4 | A-833859M4 |
| 7 | Traction Drive | 1 | 833874M1 | A-833874M1 |
| 8 | Air Intake Drive | 1 | 216897M1 | A-216897M1 |
| 9 | Discharge Drive Grain Tank | 1 | 833873M1 | A-833873M1 |
| 10 | Counter shaft - Shoe - Fan | 1 | 842851M1 | A-842851M1 |
| 11 | Straw Spreader Drive | 1 | 842110M1 | A-842110M1 |
| 12 | Straw Walker Drive | 1 | 843310M1 | A-843310M1 |
| 12 | Straw Walker Drive | 1 | 833855M1 | A-833855M1 |
| 14 | Shaker Shoe Drive | 1 | 842419M1 | A-842419M1 |
| 15 | Small Seed Kit | 1 | 842423M1 | A-842423M1 |
| 16 | Hydraulic Pump Drive | 1 | 842413M1 | A-842413M1 |
| 16 | Hydraulic Pump Drive | 1 | 222882M2 | A-222882M2 |
| 17 | Radiator Fan Drive | 1 | 273837M91 | A-273837M91 |
| 18 | Alternator Drive (diesel Engine) | 1 | 259047M91 | A-259047M91 |
| 19 | Air Conditioning Compressor Drive | 1 | 834492M2 | A-834492M2 |
| 19 | Air Conditioning Compressor Drive | 1 | 843045M1 | A-843045M1 |
| 20 | Hydrostatic Reel drive | 1 | 842845M1 | A-842845M1 |
| 22 | Straw Chopper Drive | 1 | 833871M1 | A-833871M1 |
| 23 | Straw Chopper Drive | 1 | 832866M2 | A-832866M2 |
| 24 | Straw Chopper Drive | 1 | 833872M1 | A-833872M1 |
| 24 | Straw Chopper Drive | 1 | 843324M1 | A-843324M1 |
| 25 | Return Elevator Drive | 1 | 833854M2 | A-833854M2 |

MASSEY FERGUSON 760

| Belt No. |  | No. of Belts | OEM  Part No. | PIX  Part No. |
|----------|---|--------------|--|--|
| 1 | Reel Drive | 1 | 834139M1 | A-834139M1 |
| 2 | Selector | 1 | 834058M1 | A-834058M1 |
| 3 | Reel Drive | 1 | 834140M1 | A-834140M1 |
| 4 | Straw Cutter | 1 | 832866M2 | A-832866M2 |
| 5 | Alternator Drive li | 1 | 273837M91 | A-273837M91 |
| 6 | Alternator Drive li | 1 | 521398M91 | A-521398M91 |
| 7 | Air Aspirator | 1 | 833867M1 | A-833867M1 |
| 8 | Alternator Drive I | 1 | 274252M91 | A-274252M91 |
| 9 | Fan Drive | 1 | 274339M91 | A-274339M91 |
| 10 | Straw Cutter | 1 | 833871M1 | A-833871M1 |
| 11 | Central Transmission | 1 | 833865M1 | A-833865M1 |
| 12 | Air Conditioning Compressor Drive | 1 | 834492M2 | A-834492M2 |
| 13 | Hydraulic Pump Drive | 1 | 842413M1 | A-842413M1 |
| 14 | Ventilator | 1 | 274015M91 | A-274015M91 |
| 15 | Elevator Drive Unit | 1 | 833854M2 | A-833854M2 |
| 16 | Beater Drive | 2 | 273757M91 | A-273757M91 |
| 17 | Tank Outlet | 1 | 833862M1 | A-833862M1 |
| 18 | Straw Cutter | 1 | 833872M1 | A-833872M1 |
| 19 | Straw Shaker | 1 | 833860M1 | A-833860M1 |
| 22 | Ventilator | 1 | 833863M1 | A-833863M1 |
| 23 | Hydraulic Pump Drive | 1 | 833866M1 | A-833866M1 |



MASSEY FERGUSON 760 OLD

| Belt No. |  | No. of Belts | OEM  Part No. | PIX  Part No. |
|----------|---|--------------|--|--|
| 1 | Reel Drive | 1 | 834140M1 | A-834140M1 |
| 2 | Reel Drive Variable Speed | 1 | 833768M1 | A-833768M1 |
| 3 | Reel Drive | 1 | 834139M1 | A-834139M1 |
| 4 | Wobble Box Drive | 1 | 834058M1 | A-834058M1 |
| 4 | Wobble Box Drive | 1 | 834190M1 | A-834190M1 |
| 4 | Wobble Box Drive | 1 | 842809M1 | A-842809M1 |
| 5 | Traction Drive | 1 | 833858M4 | A-833858M4 |
| 5 | Hydrostatic Traction Drive | 1 | 833866M1 | A-833866M1 |
| 6 | Main Drive | 1 | 833865M1 | A-833865M1 |
| 7 | Air Intake Drive | 1 | 833867M1 | A-833867M1 |
| 8 | Discharge Drive Grain Tank | 1 | 833862M3 | A-833862M3 |
| 9 | Countershaft - Shoe - Fan | 1 | 842851M1 | A-842851M1 |
| 10 | Straw Spreader Drive | 1 | 842110M1 | A-842110M1 |
| 11 | Straw Walker Drive | 1 | 833860M1 | A-833860M1 |
| 11 | Straw Walker Drive | 1 | 843302M1 | A-843302M1 |
| 12 | Shaker Shoe Drive | 1 | 842419M1 | A-842419M1 |
| 13 | Cleaning Fan Drive | 1 | 842423M1 | A-842423M1 |
| 14 | Hydraulic Pump Drive | 1 | 842413M1 | A-842413M1 |
| 14 | Hydraulic Pump Drive | 1 | 222882M2 | A-222882M2 |
| 14 | Hydraulic Pump Drive | 1 | 842464M2 | A-842464M2 |
| 17 | Radiator Fan Drive | 1 | 833869M1 | A-833869M1 |
| 17 | Radiator Fan Drive | 1 | 833870M1 | A-833870M1 |
| 18 | Air Conditioning Compressor Drive | 1 | 834492M2 | A-834492M2 |
| 18 | Air Conditioning Compressor Drive | 1 | 842463M1 | A-842463M1 |
| 18 | Air Conditioning Compressor Drive | 1 | 843045M1 | A-843045M1 |
| 19 | Hydrostatic Reel drive | 1 | 842845M1 | A-842845M1 |
| 21 | Straw Chopper Drive | 1 | 833871M1 | A-833871M1 |
| 22 | Straw Chopper Drive | 1 | 832866M2 | A-832866M2 |
| 23 | Straw Chopper Drive | 1 | 833872M1 | A-833872M1 |
| 23 | Straw Chopper Drive | 1 | 843324M1 | A-843324M1 |
| 24 | Return Elevator Drive | 1 | 833854M2 | A-833854M2 |

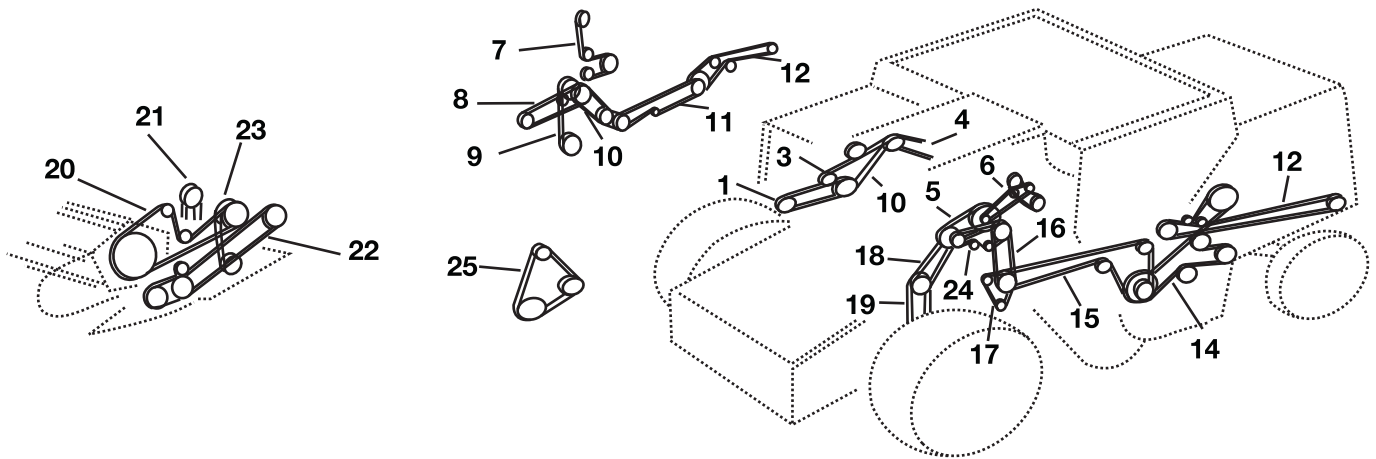
MASSEY FERGUSON 760 - 765



| Belt No. |  | No. of Belts | OEM  Part No. | PIX  Part No. |
|----------|---|--------------|--|--|
| 1 | Hydraulic Pump Drive (serial Nr. 00511-2474) | 1 | 222882M2 | A-222882M2 |
| 1 | Hydraulic Pump Drive (serial Nr. 2474 - ...) | 1 | 842413M1 | A-842413M1 |
| 1 | Radiator Fan Drive | 1 | 833870M1 | A-833870M1 |
| 1 | Hydraulic Pump Drive (serial Nr. ... - 511) | 1 | 842464M2 | A-842464M2 |
| 2 | Radiator Fan Drive | 1 | 259047M91 | A-259047M91 |
| 2 | Radiator Fan Drive | 1 | 833869M1 | A-833869M1 |
| 3 | Alternator Drive | 1 | 1687531M1 | A-1687531M1 |
| 3 | Alternator Drive | 1 | 844079M1 | A-844079M1 |
| 4 | Air Conditioning Compressor Drive | 1 | 1686883M1 | A-1686883M1 |
| 4 | Air Conditioning Compressor Drive (Serial Nr. 511-5829) | 1 | 834492M1 | A-834492M1 |
| 4 | Air Conditioning Compressor Drive (Serial Nr. ... - 511) | 1 | 842463M1 | A-842463M1 |
| 4 | Air Conditioning Compressor Drive (Serial Nr. 5829-7663) | 1 | 843045M1 | A-843045M1 |
| 5 | Main Drive | 1 | 833865M1 | A-833865M1 |
| 6 | Air Intake Drive | 1 | 833867M1 | A-833867M1 |
| 7 | Return Elevator Drive | 1 | 833854M1 | A-833854M1 |
| 9 | Reel Drive | 1 | 842845M1 | A-842845M1 |
| 10 | Straw Chopper Drive (serial Nr. ... - 9413) | 1 | 833871M1 | A-833871M1 |
| 10 | Straw Chopper Drive (serial Nr. 9413 - ...) | 1 | 843948M1 | A-843948M1 |
| 11 | Straw Chopper Drive (serial Nr. ... - 9413) | 1 | 832866M2 | A-832866M2 |
| 11 | Straw Chopper Drive (serial Nr. 9413 - ...) | 1 | 843747M1 | A-843747M1 |
| 12 | Straw Chopper Drive | 1 | 843760M1 | A-843760M1 |
| 12 | Straw Chopper Drive (serial Nr. 9413 - ...) | 1 | 832906M1 | A-832906M1 |
| 12 | Straw Chopper Drive (serial Nr. ... - 9413) | 1 | 833872M1 | A-833872M1 |
| 13 | Straw Spreader Drive | 1 | 842110M1 | A-842110M1 |
| 14 | Straw Walker Drive | 1 | 833860M1 | A-833860M1 |
| 15 | Shaker Shoe Drive | 2 | 273757M91 | A-273757M91 |
| 16 | Shaker Shoe - Countershaft - Fan (serial Nr. ... - 9413) | 1 | 274015M91 | A-274015M91 |
| 16 | Shaker Shoe - Countershaft - Fan (serial Nr. 9413 - ...) | 2 | 281560M91 | A-281560M91 |
| 17 | Cleaning Fandrive | 1 | 833863M1 | A-833863M1 |
| 17 | Cleaning Fan- Small Seed Kit | 1 | 842423M1 | A-842423M1 |
| 18 | Traction (upper) - 4 Speed | 1 | 833858M4 | A-833858M4 |



| Belt No. |  | No. of Belts | OEM  Part No. | PIX  Part No. |
|----------|---|--------------|--|--|
| 18 | Hydrostatic Traction Drive (upper) | 1 | 833866M1 | A-833866M1 |
| 19 | Traction (lower) - 4 Speed | 1 | 833858M4 | A-833858M4 |
| 19 | Hydrostatic Traction Drive (lower) | 1 | 833866M1 | A-833866M1 |
| 20 | Reel Drive | 1 | 834140M1 | A-834140M1 |
| 21 | Reel Drive Variable Speed | 1 | 833768M1 | A-833768M1 |
| 22 | Knife Drive - Ridig Cut Bar 13 Feet | 1 | 834058M1 | A-834058M1 |
| 22 | Wobble Box - With 30 Feet Table | 1 | 210774M1 | A-210774M1 |
| 22 | Knife Wobble - Ridig Cut Bar With Speed Up Kit | 1 | 832085M1 | A-832085M1 |
| 22 | Knife Wobble - Floating Cut Bar | 1 | 833962M1 | A-833962M1 |
| 22 | Knife Wobble Ridig Cut Bar - 15 Feet - 24 Feet | 1 | 834190M1 | A-834190M1 |
| 22 | Wobble Box - With Draper Table | 1 | 842809M1 | A-842809M1 |
| 23 | Reel Drive Countershaft | 1 | 834139M1 | A-834139M1 |
| 24 | Discharge Drive Grain Tank | 1 | 833862M3 | A-833862M3 |
| 24 | Alternator Drive V8 Engine (serial Nr. 13173 - ...) | 1 | 3040950M91 | A-3040950M91 |
| 25 | Alternator Drive V8 Engine (serial Nr. ... - 13173) | 1 | 844163M1 | A-844163M1 |



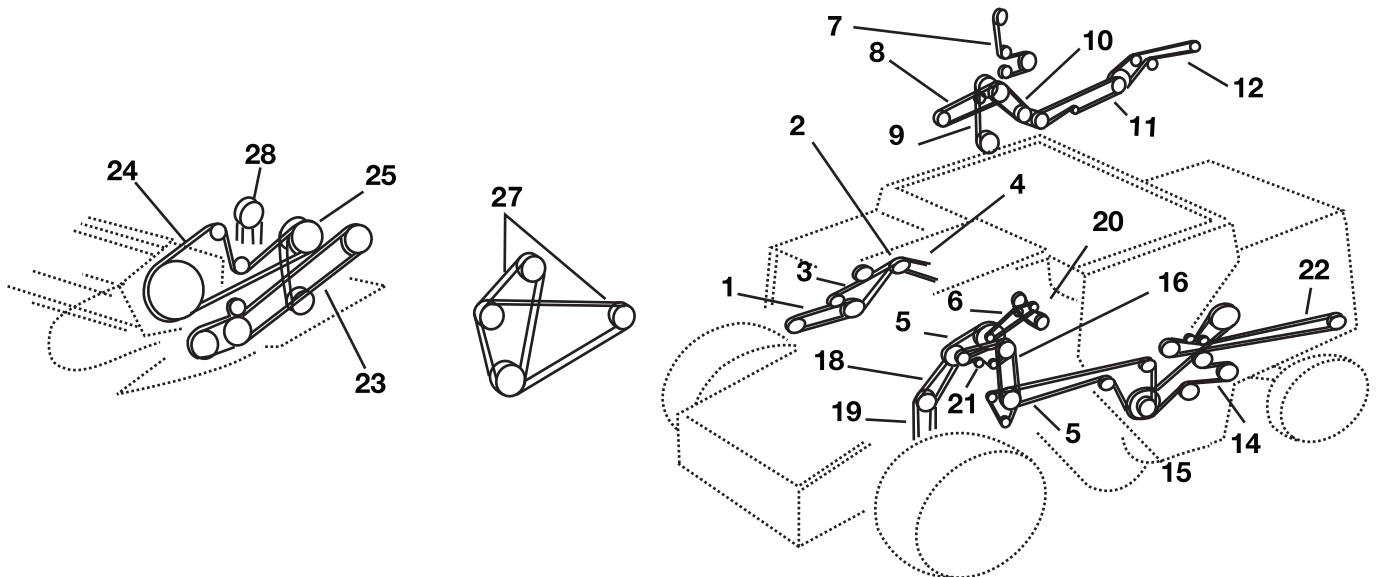

MASSEY FERGUSON 850 - 855

| Belt No. |  | No. of Belts | OEM  Part No. | PIX  Part No. |
|----------|---|--------------|--|--|
| 1 | Hydraulic Pump Drive | 1 | 842413M1 | A-842413M1 |
| 2 | Radiator Fan Drive | 2 | 265522M91 | A-265522M91 |
| 3 | Alternator Drive | 1 | 844079M1 | A-844079M1 |
| 4 | Air Conditioning Compressor Drive | 1 | 3386214M1 | A-3386214M1 |
| 4 | Air Conditioning Compressor Drive | 1 | 521110M1 | A-521110M1 |
| 4 | Air Conditioning Compressor Drive (serial Nr. -25658) | 1 | 529964M1 | A-529964M1 |
| 5 | Main Drive - 3 Band | 1 | 833874M1 | A-833874M1 |
| 5 | Main Drive - 4 Band | 1 | 844475M1 | A-844475M1 |
| 7 | Return Elevator Drive | 1 | 833854M2 | A-833854M2 |
| 8 | Cylinder Drive | 1 | 833868M2 | A-833868M2 |
| 9 | Hydrostatic Reel drive | 1 | 842845M1 | A-842845M1 |
| 10 | Straw Chopper (front) | 1 | 843948M1 | A-843948M1 |
| 11 | Straw Chopper (center) | 1 | 843747M1 | A-843747M1 |
| 12 | Straw Chopper (rear) | 1 | 843760M1 | A-843760M1 |
| 13 | Straw Spreader (rear) | 1 | 842110M1 | A-842110M1 |
| 14 | Straw Walker Drive | 1 | 843310M1 | A-843310M1 |
| 15 | Shaker Shoe Drive | 2 | 273757M91 | A-273757M91 |
| 16 | Shaker Shoe - Counter shaft - Fan | 1 | 281560M1 | A-281560M1 |
| 17 | Cleaning Fan Drive | 1 | 833863M1 | A-833863M1 |
| 17 | Cleaning Fan - Small Seed Kit | 1 | 842423M1 | A-842423M1 |
| 18 | Traction (upper) - 4 Speed | 1 | 833858M4 | A-833858M4 |
| 18 | Traction (upper) (serial Nr. 27544 - ...) | 1 | 833866M1 | A-833866M1 |
| 18 | Hydrostatic Traction Drive (upper) | 1 | 844077M1 | A-844077M1 |
| 19 | Traction (lower) - 4 Speed | 1 | 833859M4 | A-833859M4 |
| 19 | Hydrostatic Traction Drive (lower) | 1 | 833866M1 | A-833866M1 |
| 21 | Tank Unloader Drive | 1 | 833873M1 | A-833873M1 |
| 23 | Wobble Box - Rigid Cutbar - Sp. Up | 1 | 195671M1 | A-195671M1 |
| 23 | Wobble Box - Rigid Cutbar - 22 Feet - 24 Feet Table | 1 | 210774M1 | A-210774M1 |
| 23 | Wobble Box - Floating Cut Bar 22 Feet | 1 | 227455M1 | A-227455M1 |
| 23 | Wobble Box - Floating Cut Bar 15 Feet - 20 Feet | 1 | 833962M1 | A-833962M1 |
| 23 | Wobble Box - Rigid Cutbar 15 Feet - 20 Feet Table | 1 | 834190M1 | A-834190M1 |
| 24 | Reel Drive | 1 | 834140M1 | A-834140M1 |
| 25 | Reel Drive Counter shaft | 1 | 834139M1 | A-834139M1 |
| 26 | Reel Drive Variable Speed | 1 | 833768M1 | A-833768M1 |





| Belt No. |  | No. of Belts | OEM  Part No. | PIX  Part No. |
|----------|---|--------------|--|--|
| 1 | Hydraulic Pump Drive | 1 | 842413M1 | A-842413M1 |
| 2 | Radiator And Fan Drive (serial Nr. ... - 16559) | 1 | 259047M91 | A-259047M91 |
| 2 | Radiator And Fan Drive (serial Nr. 15558 - ...) | 1 | 284633M91 | A-284633M91 |
| 3 | Alternator Drive 6-cylinder Engine | 1 | 844079M1 | A-844079M1 |
| 4 | Air Conditioning Compressor Drive | 1 | 529964M1 | A-529964M1 |
| 5 | Main Drive | 1 | 833865M1 | A-833865M1 |
| 6 | Rotary Screen - Countershaft | 1 | 833867M1 | A-833867M1 |
| 7 | Return Elevator Drive | 1 | 833854M2 | A-833854M2 |
| 9 | Hydraulic Reel Pump Drive | 1 | 842845M1 | A-842845M1 |
| 10 | Straw Chopper (front) | 1 | 843948M1 | A-843948M1 |
| 11 | Straw Chopper (center) | 1 | 843747M1 | A-843747M1 |
| 12 | Straw Chopper (rear) 102.5 Inch | 1 | 843760M1 | A-843760M1 |
| 12 | Straw Chopper (rear) 224 Inch | 1 | 844496M1 | A-844496M1 |
| 13 | Straw Spreader (rear) | 1 | 842110M1 | A-842110M1 |
| 14 | Straw Walker Drive | 1 | 843302M1 | A-843302M1 |
| 15 | Shaker Shoe Drive | 2 | 273757M91 | A-273757M91 |
| 16 | Shaker Shoe - Countershaft - Fan | 1 | 281560M1 | A-281560M1 |
| 17 | Cleaning Fandrive | 1 | 833863M1 | A-833863M1 |
| 17 | Cleaning Fan- Small Seed Kit | 1 | 842423M1 | A-842423M1 |
| 18 | Traction (upper) - 4 Speed | 1 | 833858M4 | A-833858M4 |
| 18 | Traction (upper) (serial Nr. ... - 18278) | 1 | 833866M1 | A-833866M1 |
| 18 | Traction (upper) (serial Nr. 18277 - ...) | 1 | 844336M1 | A-844336M1 |
| 19 | Traction (lower) - 4 Speed (serial Nr. 19115 - ...) | 1 | 833857M4 | A-833857M4 |
| 19 | Traction (lower) - 4 Speed (serial Nr. ... - 19115) | 1 | 833858M4 | A-833858M4 |
| 19 | Traction (lower) (serial Nr. ...-18278) | 1 | 833866M1 | A-833866M1 |
| 19 | Traction (lower) (serial Nr. 18278 - ...) | 1 | 844336M1 | A-844336M1 |
| 20 | Countershaft - Rotary Screen | 1 | 844306M1 | A-844306M1 |
| 21 | Tank Unloader Drive | 1 | 833862M3 | A-833862M3 |
| 22 | Wobble Box - Floating Cut Bar 22 Feet | 1 | 227455M1 | A-227455M1 |
| 22 | Wobble Box - Floating Cut Bar 22 Feet | 1 | 832832M1 | A-832832M1 |
| 22 | Wobble Box - Floating Cut Bar 15 Feet - 20 Feet | 1 | 833962M1 | A-833962M1 |

MASSEY FERGUSON 860 - 865



| Belt No. |  | No. of Belts | OEM  Part No. | PIX  Part No. |
|----------|---|--------------|--|--|
| 23 | Wobble Box - Rigid Cut Bar 15 Feet - 20 Feet Table | 1 | 195671M1 | A-195671M1 |
| 23 | Wobble Box - Rigid Cut Bar - 22 Feet - 24 Feet Table | 1 | 210774M1 | A-210774M1 |
| 23 | Wobble Box Drive | 1 | 834190M1 | A-834190M1 |
| 23 | Draper Table | 1 | 842809M1 | A-842809M1 |
| 24 | Reel Drive | 1 | 834140M1 | A-834140M1 |
| 25 | Reel Drive Countershaft | 1 | 834139M1 | A-834139M1 |
| 27 | Alternator And Waterpump Drive 8v. Engine | 1 | 844163M1 | A-844163M1 |

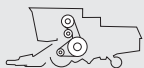

MASSEY FERGUSON 890 OLD - 890S - 892 OLD

| Belt No. |  | No. of Belts | OEM  Part No. | PIX  Part No. |
|----------|---|--------------|--|--|
| 1 | Reel Drive | 1 | 211666M1 | A-211666M1 |
| 2 | Reel Drive Variable Speed | 1 | 210627M1 | A-210627M1 |
| 6 | Traction Variator Drive | 1 | 229863M1 | A-229863M1 |



MASSEY FERGUSON 3640

| Belt No. |  | No. of Belts | OEM  Part No. | PIX  Part No. |
|----------|---|--------------|--|--|
| 1 | Used With The A6.358 Engine | 1 | 3098153M1 | A-3098153M1 |
| 1 | Used With The A6.354.4 Engine | 1 | 3099829M1 | A-3099829M1 |
| 11 | Used With The A6.358 Engine | 1 | 1480826M1 | A-1480826M1 |
| 11 | Used With The A6.354.4 Engine | 1 | 2834466M1 | A-2834466M1 |
| 19 | Used With The A6.354.4 Engine | 1 | 3145238M1 | A-3145238M1 |
| 19 | Used With The A6.358 Engine | 1 | 487802M2 | A-487802M2 |



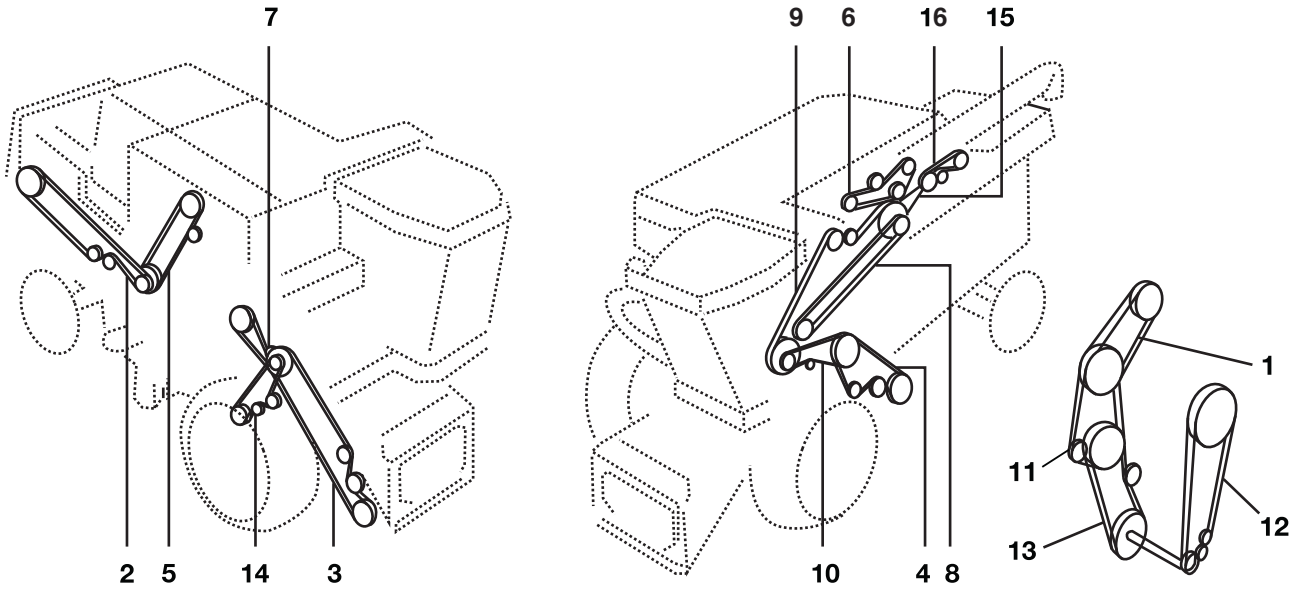

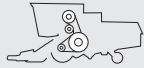

MASSEY FERGUSON 8560

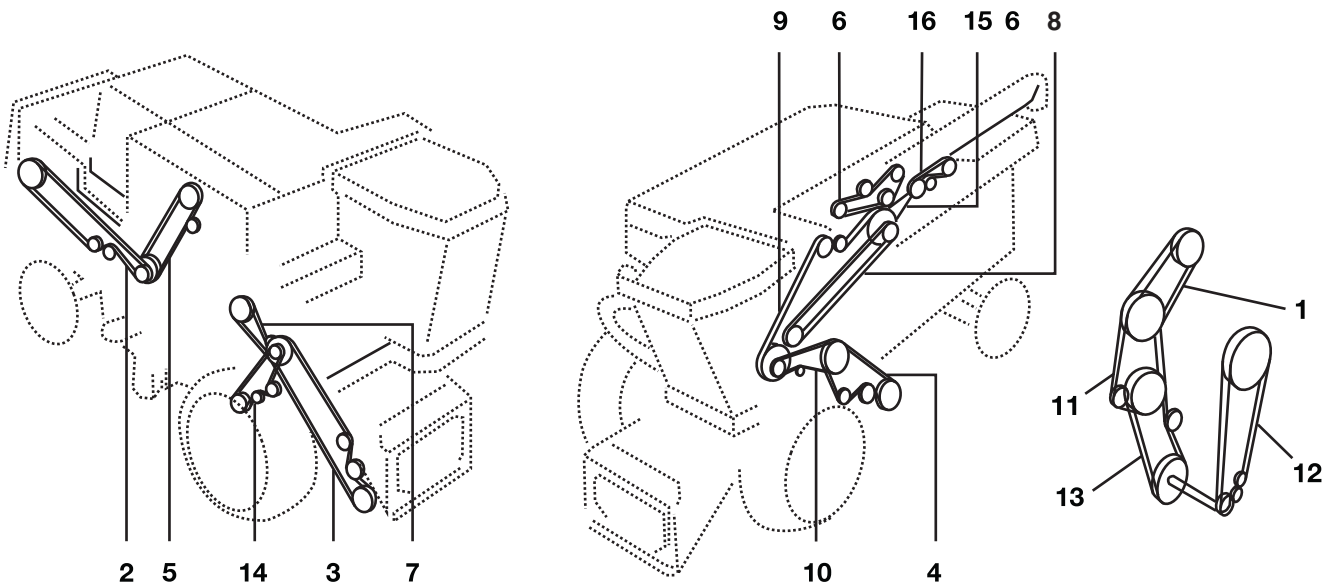

| Belt No. |  | No. of Belts | OEM  Part No. | PIX  Part No. |
|----------|---|--------------|--|--|
| 1 | Air Conditioning Compressor Drive | 1 | 525906M1 | A-525906M1 |
| 3 | Table Drive Feeder | 1 | 2621170W1 | A-2621170W1 |
| 4 | Elevator Drive Grain | 1 | 227455M1 | A-227455M1 |
| 5 | Jackshaft - Spreader | 1 | 227455M1 | A-227455M1 |
| 6 | Propulsion Pump Drive | 1 | 9811830W2 | A-9811830W2 |
| 7 | Return Elevator Drive | 1 | 619760W1 | A-619760W1 |
| 8 | Unloading Drive | 1 | 101102M1 | A-101102M1 |
| 9 | Beater Drive | 1 | 624390W1 | A-624390W1 |
| 10 | Shaker Shoe Pitman Drive | 1 | 2593000W1 | A-2593000W1 |
| 12 | Rotary Screen Drive | 1 | 1764410W1 | A-1764410W1 |
| 14 | Fan Drive Variable Speed | 1 | 2612330W1 | A-2612330W1 |
| 15 | Feeder Impeller Drive | 1 | 1594240W1 | A-1594240W1 |
| 16 | Rotor Drive | 1 | 1669570W1 | A-1669570W1 |



MASSEY FERGUSON 8570



| Belt No. |  | No. of Belts | OEM  Part No. | PIX  Part No. |
|----------|---|--------------|--|--|
| 1 | Air Conditioning Compressor Drive | 1 | 531603M1 | A-531603M1 |
| 2 | Chopper Drive | 1 | 103320M1 | A-103320M1 |
| 2 | Spreader Drive | 1 | 1680230W1 | A-1680230W1 |
| 3 | Feeder Drive High Capacity (4 Rib) | 1 | 104072W1 | A-104072W1 |
| 3 | Standard Feeder Drive (3 Rib) | 1 | 2621170W1 | A-2621170W1 |
| 4 | Elevator Drive Grain | 1 | 227455M1 | A-227455M1 |
| 5 | Chopper Drive - Jackshaft | 1 | 103319M1 | A-103319M1 |
| 5 | Spreader Jackshaft Drive | 1 | 227455M1 | A-227455M1 |
| 6 | Propulsion Pump (240hp Engine) | 1 | 104179W1 | A-104179W1 |
| 6 | Propulsion Pump (220hp Engine) | 1 | 9811830W2 | A-9811830W2 |
| 7 | Return Elevator Drive | 1 | 2619760W1 | A-2619760W1 |
| 8 | Unloading Drive | 1 | 101102M1 | A-101102M1 |
| 9 | Beater Drive | 1 | 2624390W1 | A-2624390W1 |
| 10 | Shaker Shoe Pitman Drive | 1 | 2593000W1 | A-2593000W1 |
| 11 | Alternator And Fandrive (serial Nr. ... - 45050296) | 1 | 1076753M1 | A-1076753M1 |
| 12 | Rotary Screen Drive | 1 | 1764410W1 | A-1764410W1 |
| 13 | Rotary Screen - Countershaft (240hp Engine) | 1 | 104259W1 | A-104259W1 |
| 13 | Rotary Screen - Countershaft (220hp Engine) | 1 | 2624080W1 | A-2624080W1 |
| 14 | Fan Drive Variable Speed | 1 | 2612330W1 | A-2612330W1 |
| 15 | Main Countershaft Drive (240hp Engine) | 1 | 104180W1 | A-104180W1 |
| 15 | Main Countershaft Drive (220hp Engine) | 1 | 1594240W1 | A-1594240W1 |
| 16 | Rotor Pump Drive | 1 | 9811830W2 | A-9811830W2 |

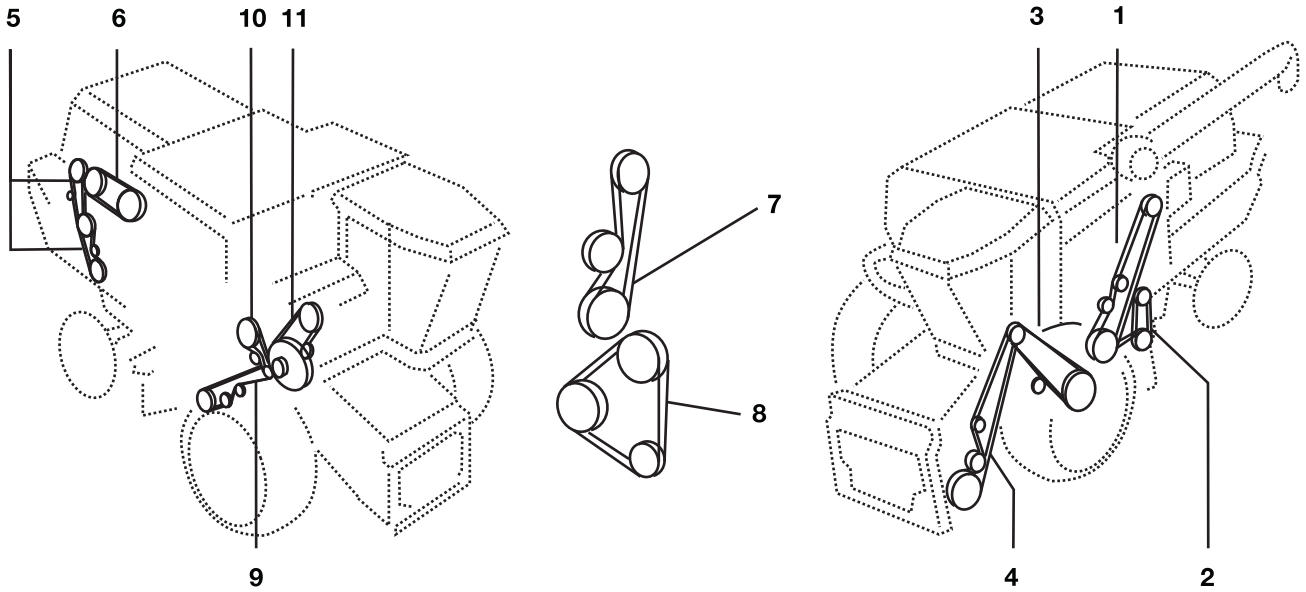

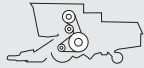
MASSEY FERGUSON 8590



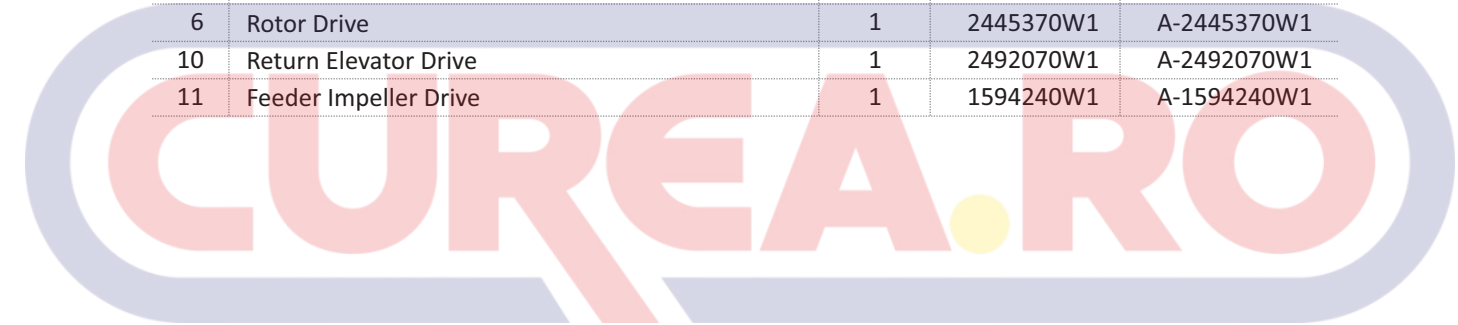

| Belt No. |  | No. of Belts | OEM  Part No. | PIX  Part No. |
|----------|---|--------------|--|--|
| 2 | Elevator Drive Grain | 1 | 2439700W1 | A-2439700W1 |
| 4 | Head Countershaft Drive | 1 | 2523670W1 | A-2523670W1 |
| 6 | Rotor Drive | 1 | 2445370W1 | A-2445370W1 |
| 10 | Return Elevator Drive | 1 | 2492070W1 | A-2492070W1 |
| 11 | Feeder Impeller Drive | 1 | 1594240W1 | A-1594240W1 |



MASSEY FERGUSON 8780



| Belt No. |  | No. of Belts | OEM  Part No. | PIX  Part No. |
|----------|---|--------------|--|--|
| 1 | Feeder Drive | 1 | 71379105 | A-71379105 |
| 2 | Fan Drive | 1 | 2612330W1 | A-2612330W1 |
| 3 | Elevator Drive Unit (prior To Motor Nr MJ87101) | 1 | 2619760W1 | A-2619760W1 |
| 3 | Elevator Drive Unit (following Motor Nr MJ87101) | 1 | 71385801 | A-71385801 |
| 5 | Chopper Drive - 2nd Stage (prior To Motor Nr MJ87101) | 1 | 103320M1 | A-103320M1 |
| 5 | Chopper Drive - 2nd Stage (following Motor Nr MJ87101) | 1 | 71388712 | A-71388712 |
| 6 | Chopper Drive Primary | 1 | 227455M1 | A-227455M1 |
| 6 | Chopper Drive Primary(prior To Motor Nr MJ87101) | 1 | 103319M1 | A-103319M1 |
| 6 | Chopper Drive Primary (following Motor Nr MJ87101) | 1 | 71385837 | A-71385837 |
| 7 | Unloading Drive | 1 | 101102M1 | A-101102M1 |
| 8 | - | 1 | 1764410W1 | A-1764410W1 |
| 9 | Reel Drive | 1 | 227455M1 | A-227455M1 |
| 10 | Pitman Drive | 1 | 2593000W1 | A-2593000W1 |
| 11 | - | 1 | 104259W1 | A-104259W1 |
| 12 | Beater Drive | 1 | 71386352 | A-71386352 |
| 14 | Main Counter shaft Drive (prior To Motor Nr MJ87101) | 1 | 71385693 | A-71385693 |
| 14 | Main Counter shaft Drive (following Motor Nr MJ87101) | 1 | 71387775 | A-71387775 |
| 15 | Hydraulic Pump Rotor Drive | 1 | 111954W1 | A-111954W1 |
| 16 | Fan Drive (prior To Motor Nr MJ87101) | 1 | 531603M1 | A-531603M1 |
| 16 | Fan Drive (following Motor Nr MJ87101) | 1 | 71148120 | A-71148120 |

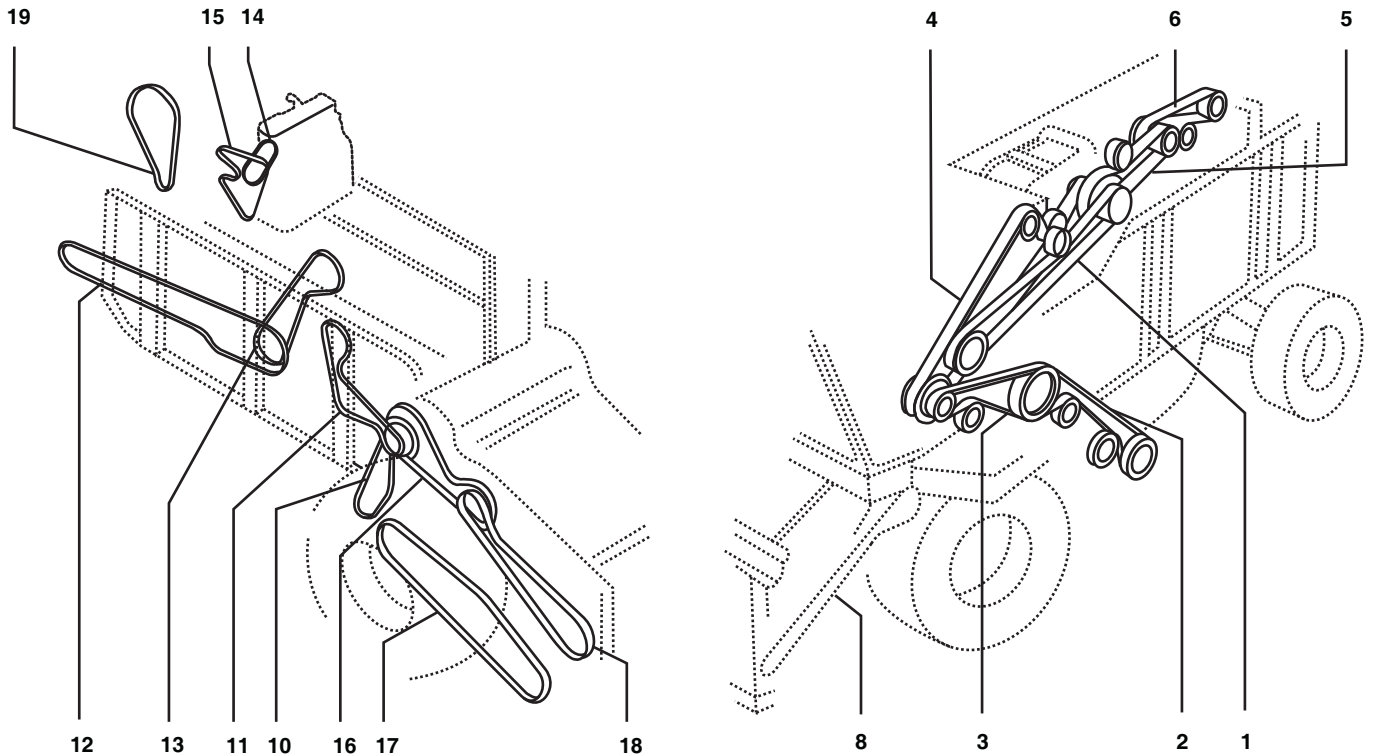

MASSEY FERGUSON 9720

| Belt No. |  | No. of Belts | OEM  Part No. | PIX  Part No. |
|----------|---|--------------|--|--|
| 2 | Elevator Drive Grain | 1 | 2439700W1 | A-2439700W1 |
| 4 | Head Counter Shaft Drive | 1 | 2523670W1 | A-2523670W1 |
| 6 | Rotor Drive | 1 | 2445370W1 | A-2445370W1 |
| 10 | Return Elevator Drive | 1 | 2492070W1 | A-2492070W1 |
| 11 | Feeder Impeller Drive | 1 | 1594240W1 | A-1594240W1 |
| 11 | Hydrostatic Pump Drive | 1 | 31-2449520 | A-31-2449520 |

MASSEY FERGUSON CHALLENGER 660





| Belt No. | | No. of Belts | OEM  Part No. | PIX  Part No. |
|----------|--|--------------|--|--|
| 1 | Unloading Drive | 1 | 101102M1 | A-101102M1 |
| 2 | Elevator Drive (serial Nr. ... - Hp87101) Grain | 1 | 227455M1 | A-227455M1 |
| 3 | Elevator Drive (serial Nr. Hp87101 - ...) Grain | 1 | 71403685 | A-71403685 |
| 4 | Shaker Shoe Pitman Drive | 1 | 71390199 | A-71390199 |
| 5 | Beater Drive | 1 | 71386352 | A-71386352 |
| 6 | Main Countershaft Drive | 1 | 71390188 | A-71390188 |
| 7 | Tandem Pump Drive (serial Nr. ... - Hr87101) | 1 | 71418976 | A-71418976 |
| 8 | Tandem Pump Drive (serial Nr. Hr87101 - ...) | 1 | 71418984 | A-71418984 |
| 9 | Header Countershaft To Pivot Shaft (serial Nr. Hp87101 - ...) | 1 | 71398388 | A-71398388 |
| 10 | Beater To Header Countershaft Drive (serial Nr. ... - Hp87101) | 1 | 71379105 | A-71379105 |
| 11 | Fan Drive Variable Speed | 1 | 71394352 | A-71394352 |
| 12 | Return Elevator Drive | 1 | 71385801 | A-71385801 |
| 13 | Chopper Drive - 2nd Stage (serial Nr. ... - Hr87101) | 1 | 71388712 | A-71388712 |
| 14 | Chopper Drive - 2nd Stage (serial Nr. Hr87101 - ...) | 1 | 71406339 | A-71406339 |
| 15 | Spreader Drive | 1 | 1680230w1 | A-1680230w1 |
| 16 | Spreader Jackshaft Drive | 1 | 227455M1 | A-227455M1 |
| 17 | Chopper Drive - 1st Stage (serial Nr. ... - Hr87101) | 1 | 71385837 | A-71385837 |
| 18 | Chopper Drive - 1st Stage (serial Nr. Hr87101 - ...) | 1 | 71406361 | A-71406361 |
| 19 | Air Conditioning Compressor Drive | 1 | 71148120 | A-71148120 |
| 21 | Alternator And Fan Drive - (update Kit) (cummins Engine) (serial Nr. ... - Hr87101) | 1 | A71410501 | A-A71410501 |
| 22 | Alternator And Fan Drive - (sisuengine) (serial Nr. Hr87101 - ...) | 1 | V685121585 | A-V685121585 |
| 23 | Alternator And Fan Drive (sisu Engine) (serial Nr. T11858 - ...) | 1 | V685121530 | A-V685121530 |

| Belt No. |  | No. of Belts | OEM  Part No. | PIX  Part No. |
|-----------------|---|---------------------|---|---|
| 24 | Beater To Feeder House Jackshaft Drive (serial Nr. Hp87101 - ...) | 1 | 71398384 | A-71398384 |
| 25 | Variable Speed To Header Countershaft (serial Nr. Hp87101 - ...) | 1 | 71399505 | A-71399505 |
| 26 | Jackshaft - Header Countershaft (serial Nr. Hp87101 - ...) | 1 | 71399519 | A-71399519 |
| 27 | Rotary Screen Drive (serial Nr. Hr87101 - ...) | 1 | 71396754 | A-71396754 |



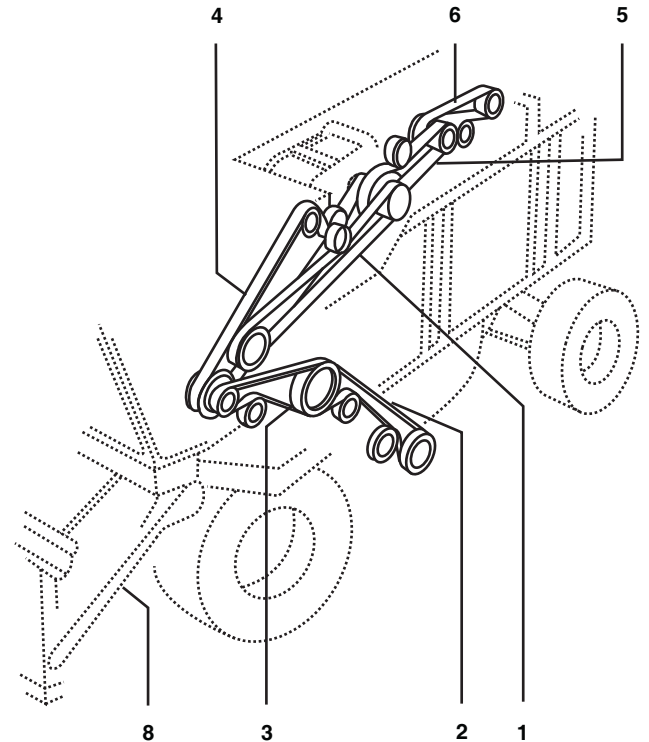
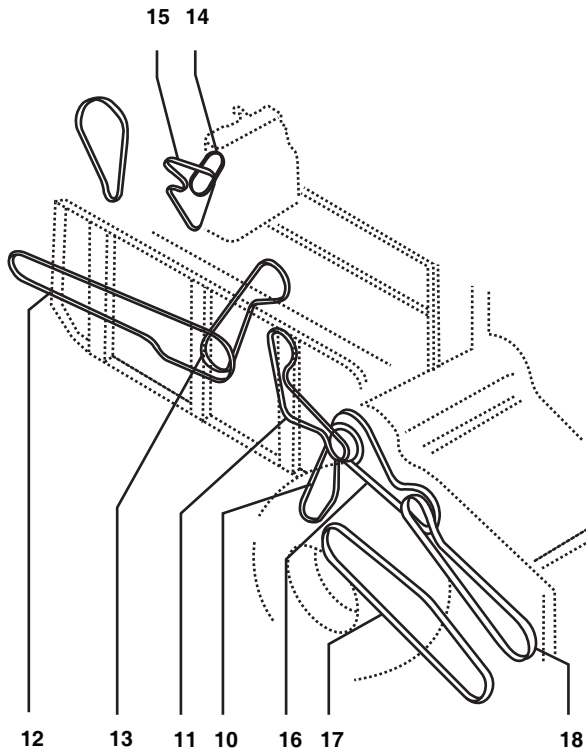

MASSEY FERGUSON CHALLENGER 660 B



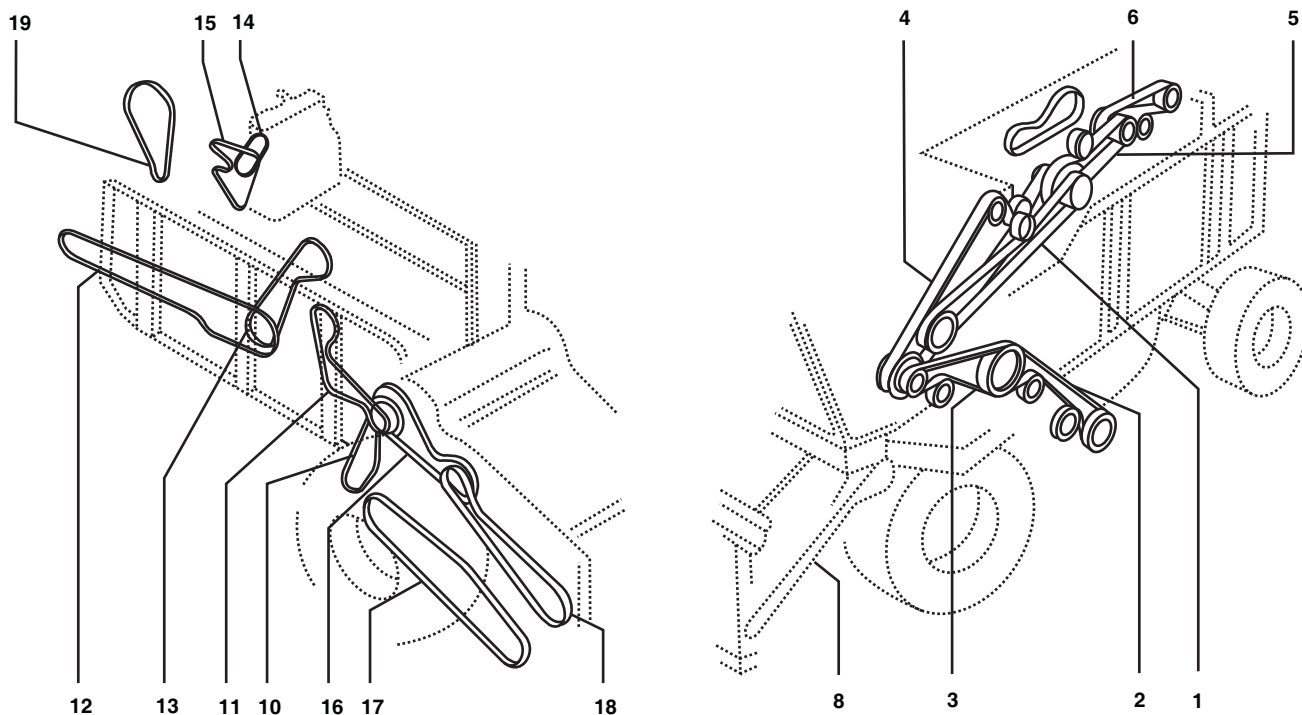

| Belt No. | | No. of Belts | OEM  Part No. | PIX  Part No. |
|----------|--------------------------------------|--------------|--|--|
| 1 | Bin Unloader Drive | 1 | 71410767 | A-71410767 |
| 2 | Drive Grain | 1 | 71410765 | A-71410765 |
| 3 | Shaker Shoe Pitman Drive | 1 | 71390199 | A-71390199 |
| 4 | Beater Drive | 1 | 71388216 | A-71388216 |
| 5 | Main Countershaft Drive | 1 | 71390188 | A-71390188 |
| 6 | Tandem Pump Drive | 1 | 71418984 | A-71418984 |
| 7 | Feeder Pivot Shaft Drive | 1 | 71427255 | A-71427255 |
| 8 | Fan Drive Variable Speed | 1 | 71394352 | A-71394352 |
| 9 | Return Elevator Drive | 1 | 71385801 | A-71385801 |
| 10 | Chopper Drive - 2nd Stage | 1 | 71406339 | A-71406339 |
| 11 | Spreader Drive (secondary) | 1 | 1680230W1 | A-1680230W1 |
| 12 | Spreader Drive (primary) | 1 | 71414420 | A-71414420 |
| 13 | Chopper Drive - 1st Stage | 1 | 71406338 | A-71406338 |
| 14 | Air Conditioning Compressor Drive | 1 | 71148120 | A-71148120 |
| 15 | Alternator And Fandrive | 1 | V685121530 | A-V685121530 |
| 16 | Beater To Feeder House Jackshaft | 1 | 71398384 | A-71398384 |
| 17 | Variable Speed Toheader Countershaft | 1 | 71399505 | A-71399505 |
| 18 | Jackshaft - Header Countershaft | 1 | 71399519 | A-71399519 |
| 19 | Rotary Screen Drive | 1 | 71396754 | A-71396754 |

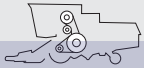
MASSEY FERGUSON CHALLENGER 670



| Belt No. |  | No. of Belts | OEM  Part No. | PIX  Part No. |
|----------|--|--------------|--|--|
| 1 | Unloading Drive | 1 | 101102M1 | A-101102M1 |
| 2 | Elevator Drive (serial Nr. ... - Hp87101) Grain | 1 | 227455M1 | A-227455M1 |
| 3 | Elevator Drive (serial Nr. Hp87101 - ...) Grain | 1 | 71403685 | A-71403685 |
| 4 | Shaker Shoe Pitman Drive | 1 | 71390199 | A-71390199 |
| 5 | Beater Drive | 1 | 71388216 | A-71388216 |
| 6 | Main Countershaft Drive | 1 | 71390188 | A-71390188 |
| 7 | Rotor Pump Drive (serial Nr. ... - Hr36101) | 1 | 71418976 | A-71418976 |
| 8 | Propulsion Pump Drive (serial Nr. Hr36101 - ...) | 1 | 71418984 | A-71418984 |
| 9 | Header Countershaft To Pivot Shaft (serial Nr. Hp36101 - ...) | 1 | 71398388 | A-71398388 |
| 10 | Beater To Header Countershaft Drive (serial Nr. ... - Hp36101) | 1 | 71379105 | A-71379105 |
| 11 | Fan Drive Variable Speed | 1 | 71394352 | A-71394352 |
| 12 | Return Elevator Drive | 1 | 71385801 | A-71385801 |
| 13 | Chopper Drive - 2nd Stage (serial Nr. ... - Hr36101) | 1 | 71388712 | A-71388712 |
| 14 | Chopper Drive - 2nd Stage (serial Nr. Hr36101 - ...) | 1 | 71406339 | A-71406339 |
| 15 | Spreader Drive | 1 | 1680230W1 | A-1680230W1 |
| 16 | Spreader Jackshaft Drive | 1 | 227455M1 | A-227455M1 |
| 17 | Chopper Drive - 1st Stage (serial Nr. ... - Hr36101) | 1 | 71385837 | A-71385837 |
| 18 | Chopper Drive - 1st Stage (serial Nr. Hr36101 - ...) | 1 | 71406361 | A-71406361 |
| 19 | Air Conditioning Compressor Drive | 1 | 71148120 | A-71148120 |
| 21 | Alternator And Fan Drive - (update Kit) (cummins Engine) (serial Nr. ... - Hr36101) | 1 | A71410501 | A-A71410501 |
| 22 | Alternator And Fan Drive (sisu Engine) (serial Nr. Hr36101 - ...) | 1 | V685121585 | A-V685121585 |
| 23 | Alternator Drive (sisu Engine) (serial Nr. T11858 - ...) | 1 | V685121530 | A-V685121530 |
| 24 | Beater To Feeder House Jackshaft Drive (serial Nr. Hp36101 - ...) | 1 | 71398384 | A-71398384 |



MASSEY FERGUSON CHALLENGER 670

| Belt No. |  | No. of Belts | OEM  Part No. | PIX  Part No. |
|-----------------|---|---------------------|---|---|
| 25 | Variable Speed To Header Countershaft (serial Nr. Hp36101 - ...) | 1 | 71399505 | A-71399505 |
| 26 | Jackshaft - Header Countershaft (serial Nr. Hp36101 - ...) | 1 | 71399519 | A-71399519 |
| 27 | Rotary Screen Drive | 1 | 71396754 | A-71396754 |



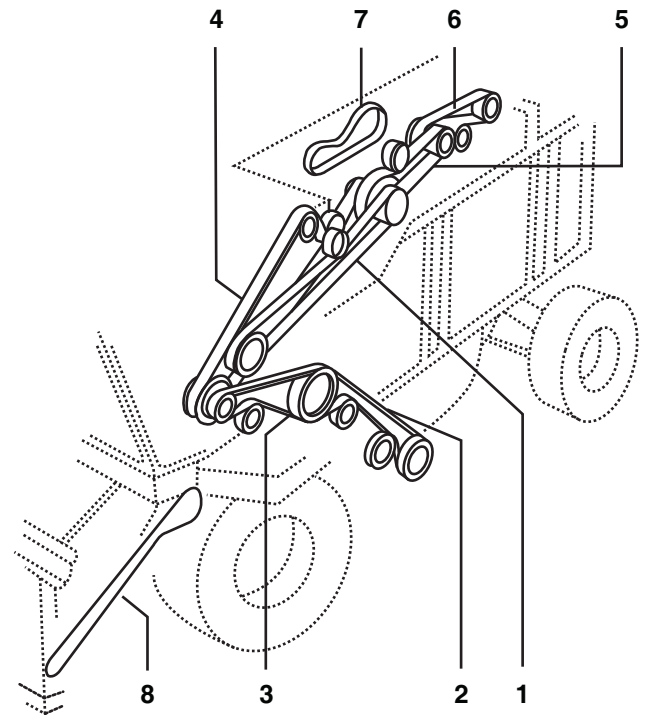
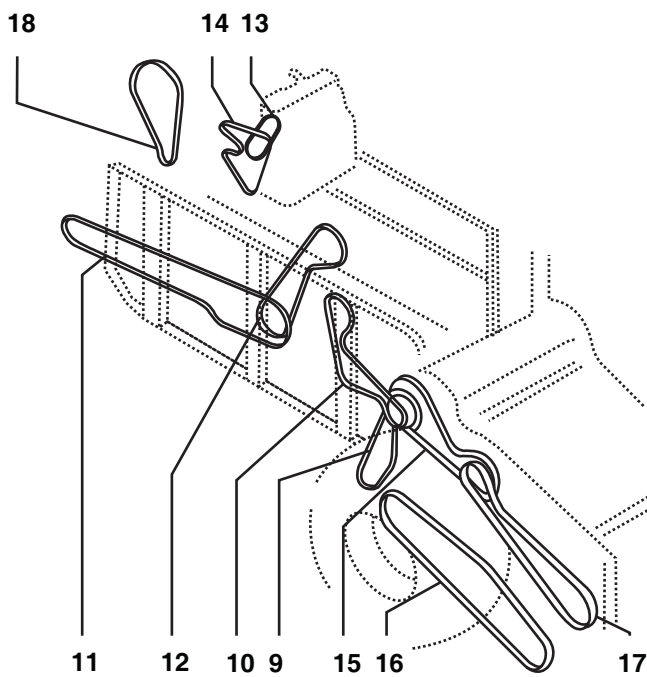

MASSEY FERGUSON CHALLENGER 670 B



| Belt No. | | No. of Belts | OEM  Part No. | PIX  Part No. |
|----------|--------------------------------------|--------------|--|--|
| 1 | Unloading Drive | 1 | 71410767 | A-71410767 |
| 2 | Elevator Drive Grain | 1 | 71410765 | A-71410765 |
| 3 | Shaker Shoe Pitman Drive | 1 | 71390199 | A-71390199 |
| 4 | Beater Drive | 1 | 71388216 | A-71388216 |
| 5 | Main Countershaft Drive | 1 | 71390188 | A-71390188 |
| 6 | Rotor Pump Drive | 1 | 71418976 | A-71418976 |
| 7 | Propulsion Pump Drive | 1 | 71418978 | A-71418978 |
| 8 | Feeder Pivot Shaft Drive | 1 | 71427255 | A-71427255 |
| 9 | Fan Drive Variable Speed | 1 | 71394352 | A-71394352 |
| 10 | Return Elevator Drive | 1 | 71385801 | A-71385801 |
| 11 | Chopper Drive - 2nd Stage | 1 | 71406339 | A-71406339 |
| 12 | Spreader Drive (secondary) | 1 | 1680230W1 | A-1680230W1 |
| 13 | Spreader Drive (primary) | 1 | 71414420 | A-71414420 |
| 14 | Chopper Drive - 1st Stage | 1 | 71406338 | A-71406338 |
| 15 | Air Conditioning Compressor Drive | 1 | 71148120 | A-71148120 |
| 17 | Beater To Feeder House Jackshaft | 1 | 71398384 | A-71398384 |
| 18 | Variable Speed Toheader Countershaft | 1 | 71399505 | A-71399505 |
| 19 | Jackshaft - Header Countershaft | 1 | 71399519 | A-71399519 |
| 20 | Rotary Screen Drive | 1 | 71396754 | A-71396754 |

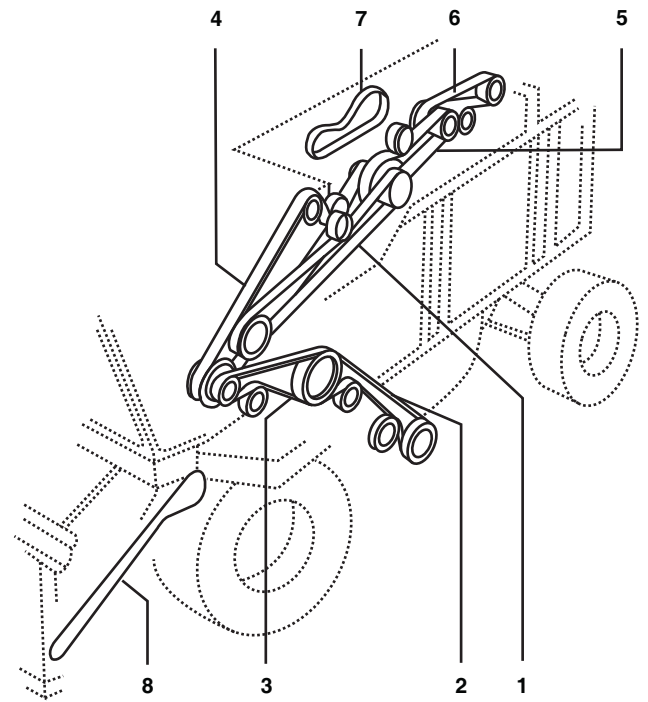
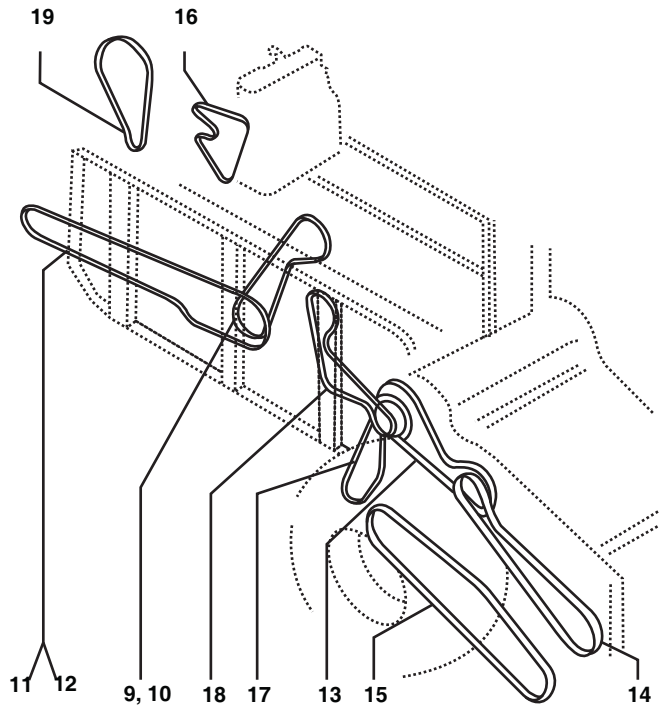

MASSEY FERGUSON CHALLENGER 680B (Prior SN HUC8101)



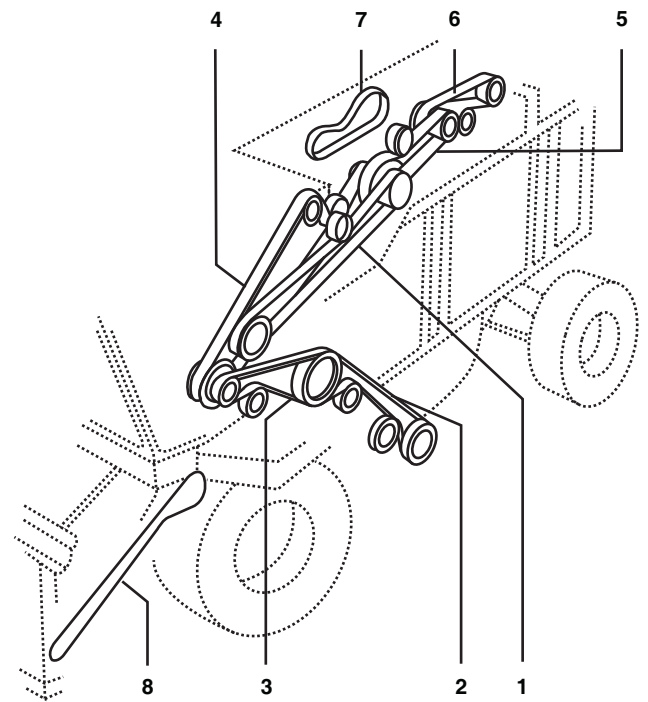
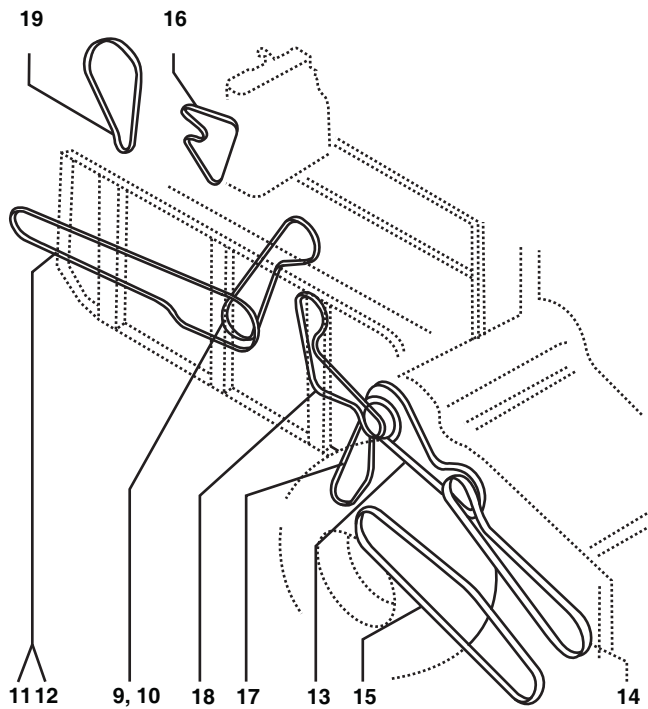

| Belt No. | | No. of Belts | OEM  Part No. | PIX  Part No. |
|----------|-----------------------------------|--------------|--|--|
| 1 | Bin Unloader Drive | 1 | 71410767 | A-71410767 |
| 2 | Grain Elevator Drive | 1 | 71403685 | A-71403685 |
| 3 | Shaker Shoe Pitman Drive | 1 | 71390199 | A-71390199 |
| 4 | Beater Drive | 1 | 71388216 | A-71388216 |
| 5 | Main Countershaft Drive | 1 | 71403721 | A-71403721 |
| 6 | Rotor Pump Drive | 1 | 71406285 | A-71406285 |
| 7 | Propel Pump Drive | 1 | 71406286 | A-71406286 |
| 8 | Feeder Conveyor Drive | 1 | 71427255 | A-71427255 |
| 9 | Spreader Drive (primary) | 1 | 71414420 | A-71414420 |
| 10 | Chopper Drive (primary) | 1 | 71406338 | A-71406338 |
| 12 | Chopper Drive (secondary) | 1 | 71406339 | A-71406339 |
| 13 | Beater-to-feeder House Jackshaft | 1 | 71398384 | A-71398384 |
| 14 | Jackshaft-to-header Countershaft | 1 | 71399519 | A-71399519 |
| 17 | Variable Speed Cleaning Fan Drive | 1 | 71400662 | A-71400662 |
| 18 | Return Elevator Drive | 1 | 71385801 | A-71385801 |
| 19 | Rotary Screen Drive | 1 | 71396754 | A-71396754 |

MASSEY FERGUSON CHALLENGER 680B (Eff. SN HUC8101)





| Belt No. | | No. of Belts | OEM  Part No. | PIX  Part No. |
|----------|--|--------------|--|--|
| 1 | Bin Unloader Drive | 1 | 71410767 | A-71410767 |
| 2 | Grain Elevator Drive | 1 | 71410765 | A-71410765 |
| 3 | Shaker Shoe Pitman Drive | 1 | 71390199 | A-71390199 |
| 4 | Beater Drive | 1 | 71388216 | A-71388216 |
| 5 | Main Counter shaft Drive | 1 | 71403721 | A-71403721 |
| 6 | Rotor Pump Drive | 1 | 71406285 | A-71406285 |
| 7 | Propel Pump Drive | 1 | 71406286 | A-71406286 |
| 8 | Feeder Conveyor Drive | 1 | 71427255 | A-71427255 |
| 9 | Spreader Drive (primary) | 1 | 71414420 | A-71414420 |
| 10 | Chopper Drive (primary) | 1 | 71406338 | A-71406338 |
| 11 | Spreader Drive (secondary) | 1 | 1680230W1 | A-1680230W1 |
| 12 | Chopper Drive (secondary) | 1 | 71406339 | A-71406339 |
| 13 | Beater-to-feeder House Jack shaft | 1 | 71398384 | A-71398384 |
| 14 | Jackshaft-to-header Counter shaft | 1 | 71399519 | A-71399519 |
| 15 | Variable Speed-to-header Counter shaft | 1 | 71423444 | A-71423444 |
| 17 | Variable Speed Cleaning Fan Drive | 1 | 71400662 | A-71400662 |
| 18 | Return Elevator Drive | 1 | 71385801 | A-71385801 |
| 19 | Rotary Screen Drive | 1 | 71396754 | A-71396754 |

MASSEY FERGUSON MF 27

| Belt No. |  | No. of Belts | OEM  Part No. | PIX  Part No. |
|----------|---|--------------|--|--|
| 1 | Feeder Drum - Counter shaft | 1 | 41983500 | A-41983500 |
| 2 | Crankshaft - Counter shaft | 1 | 41964300 | A-41964300 |
| 3 | Counter shaft (upper) - Feeder Shaft | 1 | 41989400 | A-41989400 |
| 3 | Counter shaft (upper) - Feeder Shaft | 1 | 41989200 | A-41989200 |
| 4 | Feeder Shaft (upper) - Stripper Beater | 1 | 41991700 | A-41991700 |
| 7 | Intermediate Shaft - Eccentric Shaft | 1 | 41982400 | A-41982400 |
| 8 | Auger - Lower Return Auger (grain) | 1 | 41990100 | A-41990100 |
| 8 | Auger - Lower Return Auger (grain) | 1 | 41990200 | A-41990200 |
| 9 | Counter Selector - Intermediate Shaft | 1 | 41988000 | A-41988000 |
| 9 | Intermediate Shaft - Counter Selector | 1 | 41987800 | A-41987800 |
| 10 | Stripper Beater - Counter Selector | 3 | 41934800 | A-41934800 |
| 11 | Counter Selector - Engine | 1 | 41993400 | A-41993400 |
| 12 | Engine - Hydraulic Pump | 1 | 41929000 | A-41929000 |
| 12 | Engine - Hydraulic Pump | 1 | 41930200 | A-41930200 |
| 13 | Counter Selector - Counter Drive Straw Chopper | 1 | 41942100 | A-41942100 |
| 14 | Counter Drive Straw Chopper | 1 | 41987300 | A-41987300 |
| 15 | Awner Shaft | 1 | 41912400 | A-41912400 |
| 16 | Counter Selector - Main fan | 1 | 41980400 | A-41980400 |
| 17 | Counter Selector - Awner shaft | 1 | 41990200 | A-41990200 |
| 18 | Counter Selector - Discharge Auger | 2 | 41936200 | A-41936200 |
| 20 | Filling Auger - Stripper beater | 1 | 41982500 | A-41982500 |
| 24 | Awner Shaft - Seed Grinder | 1 | 41929100 | A-41929100 |
| 25 | Main Fan Selector - Stripper Beater | 1 | 41987900 | A-41987900 |
| 28 | Main Fan Selector - Main Fan | 1 | 41982200 | A-41982200 |
| 28 | Main Fan Selector - Main Fan | 1 | 41987900 | A-41987900 |



| Belt No. |  | No. of Belts | OEM  Part No. | PIX  Part No. |
|----------|---|--------------|--|--|
| 1 | Feeder Drum - Counter shaft | 1 | 41983500 | A-41983500 |
| 1 | Feeder Drum - Counter shaft | 1 | 41983600 | A-41983600 |
| 2 | Crankshaft - Counter shaft | 1 | 41963900 | A-41963900 |
| 2 | Crankshaft - Counter shaft | 1 | 41964300 | A-41964300 |
| 3 | Counter shaft - Upper Beater Shaft | 1 | 41989400 | A-41989400 |
| 3 | Counter shaft (upper) - Feeder Shaft | 1 | 41989200 | A-41989200 |
| 4 | Feeder Shaft (upper) - Stripper beater | 1 | 41991700 | A-41991700 |
| 7 | Intermediate Shaft - Eccentric Shaft | 1 | 41982500 | A-41982500 |
| 7 | Intermediate Shaft - Eccentric Shaft | 1 | 41982400 | A-41982400 |
| 8 | Auger - Lower Return Auger (Grain) | 1 | 41990100 | A-41990100 |
| 8 | Auger - Lower Return Auger (Grain) | 1 | 41990200 | A-41990200 |
| 8 | Auger - Lower Return Auger (Grain) | 1 | 41990300 | A-41990300 |
| 8 | Auger - Lower Return Auger (Grain) | 1 | 41990400 | A-41990400 |
| 9 | Counter Selector - Intermediate Shaft | 1 | 41988000 | A-41988000 |
| 9 | Counter Selector - Intermediate Shaft | 1 | 41987800 | A-41987800 |
| 10 | Stripper Beater - Counter Selector | 3 | 41934800 | A-41934800 |
| 11 | Counter Selector - Engine | 1 | 41993400 | A-41993400 |
| 12 | Engine - Hydraulic Pump | 1 | 41929000 | A-41929000 |
| 12 | Engine - Hydraulic Pump | 1 | 41930200 | A-41930200 |
| 13 | Counter Selector - Counter Drive Straw Chopper | 1 | 41942100 | A-41942100 |
| 14 | Counter Drive Straw Chopper | 1 | 41987300 | A-41987300 |
| 15 | Awner Shaft | 1 | 41912300 | A-41912300 |
| 15 | Awner Shaft | 1 | 41912400 | A-41912400 |
| 16 | Counter Selector - Threshing Drum | 1 | 41980900 | A-41980900 |
| 17 | Counter Selector - Awner Shaft | 1 | 41990200 | A-41990200 |
| 17 | Counter Selector - Awner Shaft | 1 | 41990400 | A-41990400 |
| 18 | Counter Selector - Discharge Auger | 2 | 41936200 | A-41936200 |
| 20 | Filling Auger - Stripper Beater | 1 | 41982500 | A-41982500 |
| 24 | Awner Shaft - Seed Grinder | 1 | 41929100 | A-41929100 |
| 25 | Main Fan Variable Speed Drive - Stripper Beater | 1 | 41987900 | A-41987900 |
| 28 | Main Fan Selector - Mainfan | 1 | 41982100 | A-41982100 |
| 28 | Main Fan Selector - Mainfan | 1 | 41982200 | A-41982200 |
| 28 | Main Fan Variable Speed Drive | 1 | 41987900 | A-41987900 |

MASSEY FERGUSON MF 30 - MF 32



| Belt No. |  | No. of Belts | OEM  Part No. | PIX  Part No. |
|----------|---|--------------|--|--|
| 1 | Stripper Beater - Counter shaft | 3 | 41934800 | A-41934800 |
| 2 | Counter shaft (diesel Engine) | 1 | 41990051 | A-41990051 |
| 3 | Discharge Auger Shaft (diesel Engine) | 1 | 41990050 | A-41990050 |
| 5 | Counter shaft - Intermediate Drive For Straw | 1 | 41942200 | A-41942200 |
| 6 | Knife Drive - Counter shaft | 1 | 41985600 | A-41985600 |
| 9 | Feeder Shaft (upper) - Stripper Beater | 1 | 41991700 | A-41991700 |
| 10 | Intermediate Shaft - Eccentric Shaft | 1 | 41982100 | A-41982100 |
| 11 | Intermediate Shaft - Counter shaft | 1 | 41984100 | A-41984100 |
| 12 | Intermediate Shaft - Straw Shaker Crank | 1 | 41990068 | A-41990068 |
| 13 | Intermediate Shaft - Straw Chopper | 1 | 41978400 | A-41978400 |
| 14 | Knife Drive - Counter shaft | 1 | 41986300 | A-41986300 |
| 17 | Air Conditioning Compressor Drive | 1 | 41991000 | A-41991000 |
| 19 | Air Conditioning Compressor Drive - Suction Trainer | 1 | 41990009 | A-41990009 |
| 20 | Dust Extractor - Counter shaft | 1 | 41936700 | A-41936700 |
| 21 | Discharge Auger Shaft - Intermediate Drive - Elevator | 1 | 41979600 | A-41979600 |
| 23 | Intermediate Shaft - Fill Elevator - Strip Beater | 1 | 41950100 | A-41950100 |
| 25 | Counter Shaft - Grain Separator | 1 | 41982100 | A-41982100 |
| 26 | Main Fan Variable Speed Drive | 1 | 41982100 | A-41982100 |
| 27 | Main Fan Variable Speed Drive - Stripper Beater | 1 | 41987900 | A-41987900 |
| 28 | Counter Shaft - Threshing Drum | 1 | 41980900 | A-41980900 |
| 29 | Main Fan Variable Speed Drive - Return Elevator | 1 | 41950400 | A-41950400 |

| Belt No. |  | No. of Belts | OEM  Part No. | PIX  Part No. |
|----------|---|--------------|--|--|
| 1 | Counter Shaft - Feeder Drum | 1 | 41983500 | A-41983500 |
| 1 | Counter Shaft - Feeder Drum | 1 | 41983600 | A-41983600 |
| 2 | Counter Shaft - Crankshaft | 1 | 41963900 | A-41963900 |
| 2 | Counter Shaft - Crankshaft | 1 | 41964300 | A-41964300 |
| 3 | Counter Shaft - Stripper Beater | 1 | 41989400 | A-41989400 |
| 3 | Counter Shaft - Stripper Beater | 1 | 41989200 | A-41989200 |
| 4 | Feeder Shaft (Upper) - Stripper Beater | 1 | 41991700 | A-41991700 |
| 7 | Intermediate Shaft - Eccentric Shaft | 1 | 41982500 | A-41982500 |
| 7 | Intermediate Shaft - Eccentric Shaft | 1 | 41982400 | A-41982400 |
| 8 | Auger - Lower Return Auger (grain) | 1 | 41990069 | A-41990069 |
| 8 | Auger - Lower Return Auger (grain) | 1 | 41990100 | A-41990100 |
| 8 | Auger - Lower Return Auger (grain) | 1 | 41990300 | A-41990300 |
| 8 | Auger - Lower Return Auger (grain) | 1 | 41990400 | A-41990400 |
| 9 | Counter Selector - Intermediate Shaft | 1 | 41988000 | A-41988000 |
| 9 | Counter Selector - Intermediate Shaft | 1 | 41987800 | A-41987800 |
| 10 | Stripper Beater - Counter Selector | 3 | 41934800 | A-41934800 |
| 11 | Counter Selector - Engine | 1 | 41991300 | A-41991300 |
| 11 | Counter Selector - Engine | 1 | 41993400 | A-41993400 |
| 12 | Engine - Hydraulic Pump | 1 | 41930200 | A-41930200 |
| 13 | Counter Selector - Counter Drive Straw Chopper | 1 | 41942100 | A-41942100 |
| 14 | Counter Drive Straw Chopper | 1 | 41987600 | A-41987600 |
| 15 | Awner Shaft | 1 | 41912300 | A-41912300 |
| 15 | Awner Shaft | 1 | 41912400 | A-41912400 |
| 16 | Counter Selector - Threshing Drum | 1 | 41980900 | A-41980900 |
| 17 | Counter Selector - Awner Shaft | 1 | 41990069 | A-41990069 |
| 17 | Counter Selector - Awner Shaft | 1 | 41990400 | A-41990400 |
| 18 | Counter Selector - Discharge Auger | 2 | 41936200 | A-41936200 |
| 20 | Filling Auger - Stripper Beater | 1 | 41982500 | A-41982500 |
| 24 | Awner Shaft - Seed Grinder | 1 | 41929100 | A-41929100 |
| 25 | Main Fan Selector - Stripper Beater | 1 | 41987900 | A-41987900 |
| 28 | Main Fan Selector - Mainfan | 1 | 41982100 | A-41982100 |
| 28 | Main Fan Selector - Mainfan | 1 | 41982200 | A-41982200 |
| 28 | Main Fan Selector - Mainfan | 1 | 41987900 | A-41987900 |

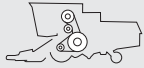

MASSEY FERGUSON MF 34

| Belt No. |  | No. of Belts | OEM  Part No. | PIX  Part No. |
|----------|---|--------------|--|--|
| 11 | - | 1 | 41979800 | A-41979800 |
| 12 | - | 1 | 41990001 | A-41990001 |
| 29 | - | 1 | 41981000 | A-41981000 |



MASSEY FERGUSON MF 38

| Belt No. |  | No. of Belts | OEM  Part No. | PIX  Part No. |
|----------|---|--------------|--|--|
| 1 | Stripper Beater - Counter Shaft | 1 | 41979900 | A-41979900 |
| 2 | Counter Shaft (diesel Engine) | 1 | 41979400 | A-41979400 |
| 3 | Discharge Auger Shaft (diesel Engine) | 1 | 41979100 | A-41979100 |
| 4 | Traction Pump (diesel Engine) | 1 | 41934200 | A-41934200 |
| 5 | Counter Shaft - Intermediate Drive For Straw | 1 | 41979600 | A-41979600 |
| 6 | Intermediate Shaft - Straw Chopper | 1 | 41978900 | A-41978900 |
| 7 | Knife Drive - Counter Shaft | 1 | 41985600 | A-41985600 |
| 7 | Knife Drive - Counter Shaft | 1 | 41986200 | A-41986200 |
| 10 | Stripper Beater | 1 | 41979800 | A-41979800 |
| 11 | Stripper Beater - Intermediate Shaft | 1 | 41990001 | A-41990001 |
| 12 | Intermediate Shaft - Eccentric Shaft | 2 | 41933700 | A-41933700 |
| 13 | Intermediate Shaft - Straw Shaker Crank | 1 | 41979000 | A-41979000 |
| 14 | Knife Drive - Counter Shaft | 1 | 41986300 | A-41986300 |
| 17 | Suction Trainer - Dust Extractor | 1 | 41911000 | A-41911000 |
| 18 | Suction Trainer - Dust Extractor | 1 | 41991200 | A-41991200 |
| 19 | Intermediate Shaft - Fill Elevator | 1 | 41986100 | A-41986100 |
| 20 | Dust Extractor - Fill Elevator | 1 | 41998800 | A-41998800 |
| 22 | Counter Shaft Drive | 2 | 41937500 | A-41937500 |
| 23 | Discharge Auger Shaft | 1 | 41978800 | A-41978800 |
| 23 | Discharge Auger Shaft | 1 | 41979200 | A-41979200 |
| 25 | Air Conditioning Compressor Drive | 1 | 41909000 | A-41909000 |
| 27 | Main Fan Variable Speed Drive - Stripper Beater | 1 | 41981200 | A-41981200 |
| 28 | Main Fan Variable Speed Drive | 1 | 41981100 | A-41981100 |
| 29 | Stripper Beater - Intermediate Drive Variator | 1 | 41981000 | A-41981000 |
| 30 | Intermediate Shaft - Variator Drive Threshing Drum | 1 | 41985200 | A-41985200 |
| 31 | Intermediate Shaft - Variator Drive Threshing Drum | 1 | 41985300 | A-41985300 |



MASSEY FERGUSON WINDROWER 885

| Belt No. |  | No. of Belts | OEM  Part No. | PIX  Part No. |
|----------|---|--------------|--|--|
| 1 | Traction Drive | 1 | 1056409M1 | A-1056409M1 |
| 2 | Header Drive | 1 | 1056423M1 | A-1056423M1 |
| 3 | Sickle Drive | 1 | 1056877M1 | A-1056877M1 |
| 4 | Reel Drive | 1 | 1056914M1 | A-1056914M1 |

NEW HOLLAND 1000 & 2000 FORAGE HARVESTERS

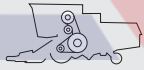

| Belt No. |  | No. of Belts | OEM  Part No. | PIX  Part No. |
|----------|---|--------------|--|--|
| 0 | Air Cleaner (caterpillar Engine) (1880) | 1 | 254084 | A-254084 |
| 2 | Air Conditioning (1890) | 1 | 264557 | A-264557 |
| 2 | Air Conditioning (1895) | 1 | 254084 | A-254084 |
| 3 | Hydraulic Pump (1890) | 1 | 573957 | A-573957 |
| 5 | Reversing Gearbox Drive (1890) | 1 | 245213 | A-245213 |
| 5 | Reversing Gearbox Drive (1895) | 1 | 616484 | A-616484 |
| 6 | Fan Drive (1890) | 1 | 266408 | A-266408 |
| 7 | Cutterhead (1890, 1895) | 1 | 244853 | A-244853 |
| 7 | Cutterhead (1890-1895 (european Machines Only)) | 1 | 197411 | A-197411 |
| 8 | Main Drive (1900, 1915, 2100) | 2 | 632679 | A-632679 |
| 9 | Blower (low Speed) (1900, 2100, 2115) | 1 | 9611905 | A-9611905 |
| 9 | Blower (high Speed) (1900, 2100, 2115) | 1 | 9611904 | A-9611904 |
| 9 | Blower (1915) | 1 | 9611905 | A-9611905 |
| 11 | Fan (1900, 1915, 2100) | 1 | 630406 | A-630406 |
| 12 | Alternator (1900, 2100) | 1 | 80259346 | A-80259346 |
| 12 | Alternator (1915) | 1 | 858900 | A-858900 |
| 13 | Fan (1900, 2100, 2115) | 2 | 705807 | A-705807 |
| 14 | Alternator (1900, 2100, 2115) | 1 | 80259346 | A-80259346 |
| 15 | Compressor (1900, 2100, 2115) | 1 | 264557 | A-264557 |
| 16 | Cutterhead (1900, 2100, 2115) | 1 | 715130 | A-715130 |

NEW HOLLAND 1520

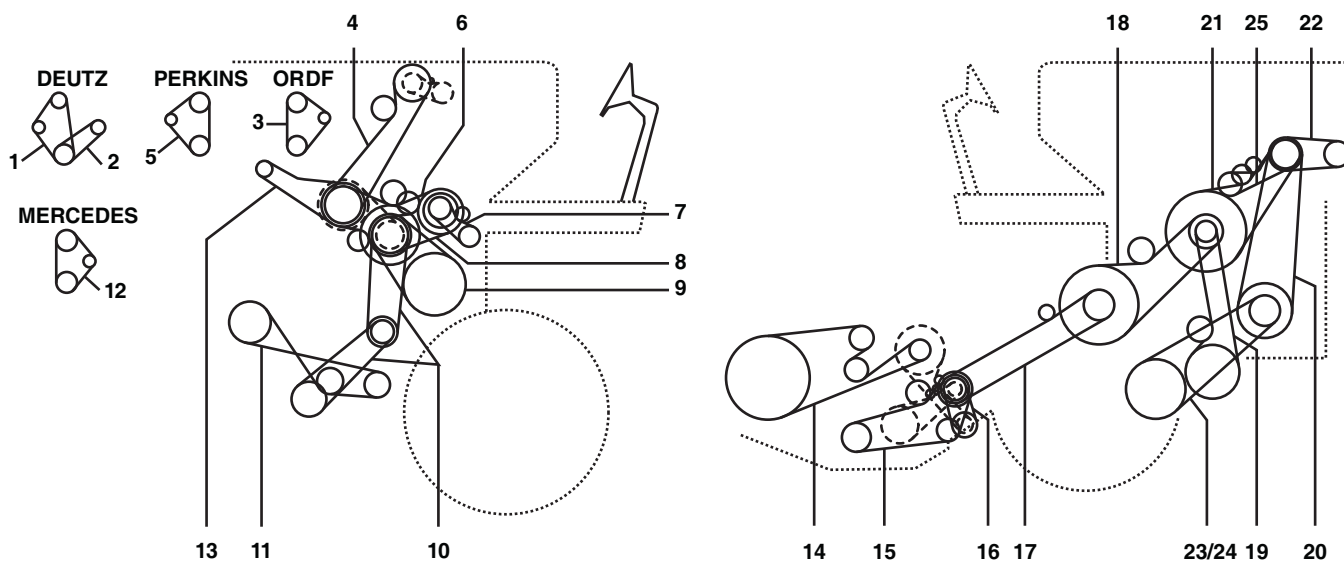

| Belt No. |  | No. of Belts | OEM  Part No. | PIX  Part No. |
|----------|---|--------------|--|--|
| 1 | Reel Drive | 1 | 80333255 | A-80333255 |
| 2 | Knife Drive | 1 | 80337415 | A-80337415 |
| 3 | Reel Drive Variable Speed | 1 | 80334065 | A-80334065 |
| 4 | Intermediate Shaft - Knife | 1 | 80330715 | A-80330715 |
| 5 | Straw Elevator Drive | 1 | 80230059 | A-80230059 |
| 6 | Ground Speed Variator drive | 1 | 80364418 | A-80364418 |
| 7 | Beater Drive | 1 | 80230079 | A-80230079 |
| 8 | Hydraulic Pump Drive | 1 | 80230043 | A-80230043 |
| 9 | Ground Speed Drive | 1 | 80328424 | A-80328424 |
| 10 | Eccentric Shaft Drive | 1 | 80230061 | A-80230061 |
| 11 | Straw Walker Drive | 1 | 80230046 | A-80230046 |
| 12 | Fan Drive (Deutz Engine) | 1 | 80327040 | A-80327040 |
| 13 | Alternator Drive (Deutz Engine) | 1 | 80327041 | A-80327041 |
| 14 | Fan Drive (ford Engine) | 1 | 80371222 | A-80371222 |
| 15 | Tailings Elevator Drive | 1 | 80230046 | A-80230046 |
| 16 | Unloading System | 1 | 80326298 | A-80326298 |
| 17 | Drum Drive Variable Speed | 1 | 80230078 | A-80230078 |
| 18 | Fan Drive Variable Speed | 1 | 80330204 | A-80330204 |

NEW HOLLAND 1530



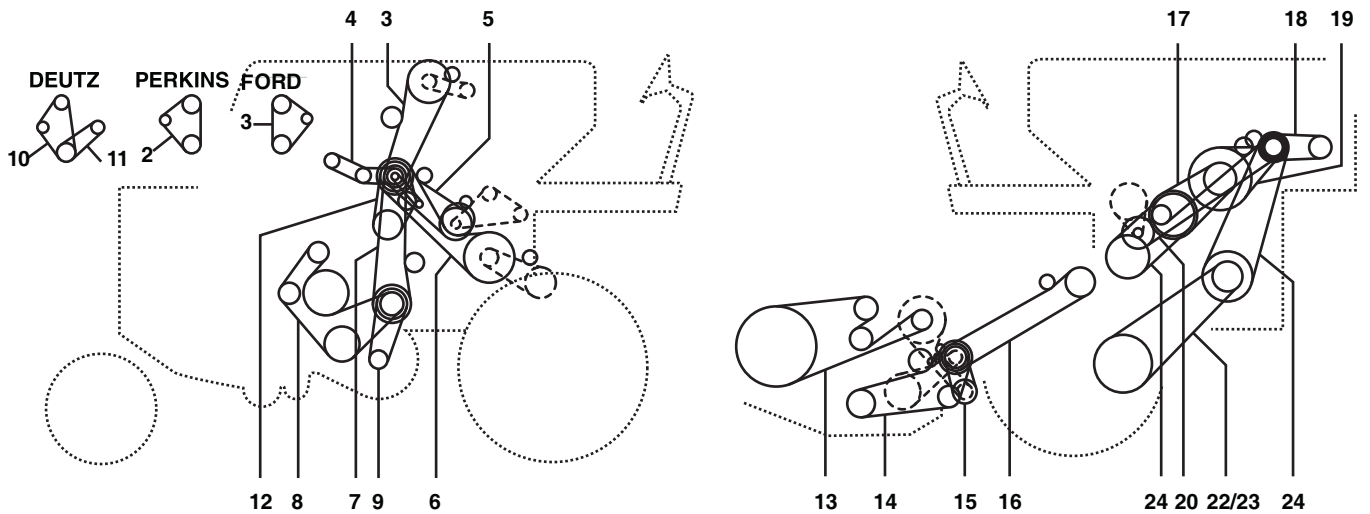

| Belt No. |  | No. of Belts | OEM  Part No. | PIX  Part No. |
|----------|---|--------------|--|--|
| 1 | Fan Drive (deutz Engine) | 1 | 80336386 | A-80336386 |
| 2 | Alternator Drive (deutz Engine) | 1 | 80336426 | A-80336426 |
| 2 | Alternator Drive (deutz Engine) | 1 | 80386155 | A-80386155 |
| 3 | Fan Drive (ford Engine) | 1 | 80371222 | A-80371222 |
| 4 | Elevator Drive Grain | 1 | 80230059 | A-80230059 |
| 4 | Elevator Drive Grain With Grain Tank Extension | 1 | 80230062 | A-80230062 |
| 6 | Tailings Elevator Drive | 1 | 80230057 | A-80230057 |
| 7 | Return Auger Drive | 1 | 80230041 | A-80230041 |
| 8 | Unloading System | 1 | 80230103 | A-80230103 |
| 9 | Drum Drive Variable Speed | 1 | 80230078 | A-80230078 |
| 10 | Fan Drive Variable Speed | 2 | 80230056 | A-80230056 |
| 11 | Straw Walker - Eccentric | 1 | 80230108 | A-80230108 |
| 13 | Straw Walker - Eccentric | 1 | 80230108 | A-80230108 |
| 14 | Reel Drive | 1 | 80333255 | A-80333255 |
| 15 | Knife Drive | 1 | 80337415 | A-80337415 |
| 16 | Reel Drive Variable Speed | 1 | 80334065 | A-80334065 |
| 17 | Intermediate Knife Drive | 1 | 80330715 | A-80330715 |
| 18 | Straw Elevator Drive | 1 | 80230073 | A-80230073 |
| 19 | Eccentric Shaft Drive | 1 | 80230060 | A-80230060 |
| 20 | - | 1 | 80230077 | A-80230077 |
| 21 | Beater Drive | 1 | 80230080 | A-80230080 |
| 22 | Hydraulic Pump Drive | 1 | 80230043 | A-80230043 |
| 23 | Traction Drive (for Pulley Dia 450mm) | 1 | 80230077 | A-80230077 |
| 24 | Traction Drive (for Pulley Dia 500mm) | 1 | 80354115 | A-80354115 |
| 25 | Auger Drive | 1 | 80309364 | A-80309364 |





| Belt No. |  | No. of Belts | OEM  Part No. | PIX  Part No. |
|----------|---|--------------|--|--|
| 1 | Ford Engine | 1 | 80371222 | A-80371222 |
| 3 | Elevator Drive Grain | 1 | 80230164 | A-80230164 |
| 3 | Elevator Drive Grain | 1 | 80353584 | A-80353584 |
| 4 | Rotary Screen Drive | 1 | 80354338 | A-80354338 |
| 5 | Tailings Elevator Drive | 1 | 80323413 | A-80323413 |
| 6 | Intermediate Reel - Knife | 1 | 80324391 | A-80324391 |
| 6 | - | 1 | 80375977 | A-80375977 |
| 7 | Fan Drive | 1 | 80230059 | A-80230059 |
| 8 | Straw Walker - Eccentric | 1 | 80333347 | A-80333347 |
| 8 | Straw Walker - Eccentric | 1 | 80378672 | A-80378672 |
| 9 | Fan Drive Variable Speed | 1 | 80320935 | A-80320935 |
| 10 | Deutz Engine | 1 | 80336386 | A-80336386 |
| 11 | Deutz Engine | 1 | 80386155 | A-80386155 |
| 12 | - | 1 | 80356913 | A-80356913 |
| 13 | Reel Drive | 1 | 80333255 | A-80333255 |
| 14 | Knife Drive | 1 | 80337415 | A-80337415 |
| 15 | Reel Drive Variable Speed | 1 | 80334065 | A-80334065 |
| 16 | Sickle Knife Drive | 2 | 80362500 | A-80362500 |
| 17 | Drum Drive Variable Speed | 1 | 80336784 | A-80336784 |
| 18 | Hydraulic Pump Drive | 2 | 80335258 | A-80335258 |
| 19 | Main Shaft Drive | 1 | 80323646 | A-80323646 |
| 20 | Unloading System | 1 | 80333958 | A-80333958 |
| 21 | Drum Drive Variable Speed | 1 | 80336784 | A-80336784 |
| 22 | Traction Drive (for Pulley Dia 450mm) | 1 | 80230077 | A-80230077 |
| 23 | Traction Drive (for Pulley Dia 526mm) | 1 | 80354115 | A-80354115 |
| 24 | Traction Drive | 1 | 80230077 | A-80230077 |

NEW HOLLAND 1540 AL

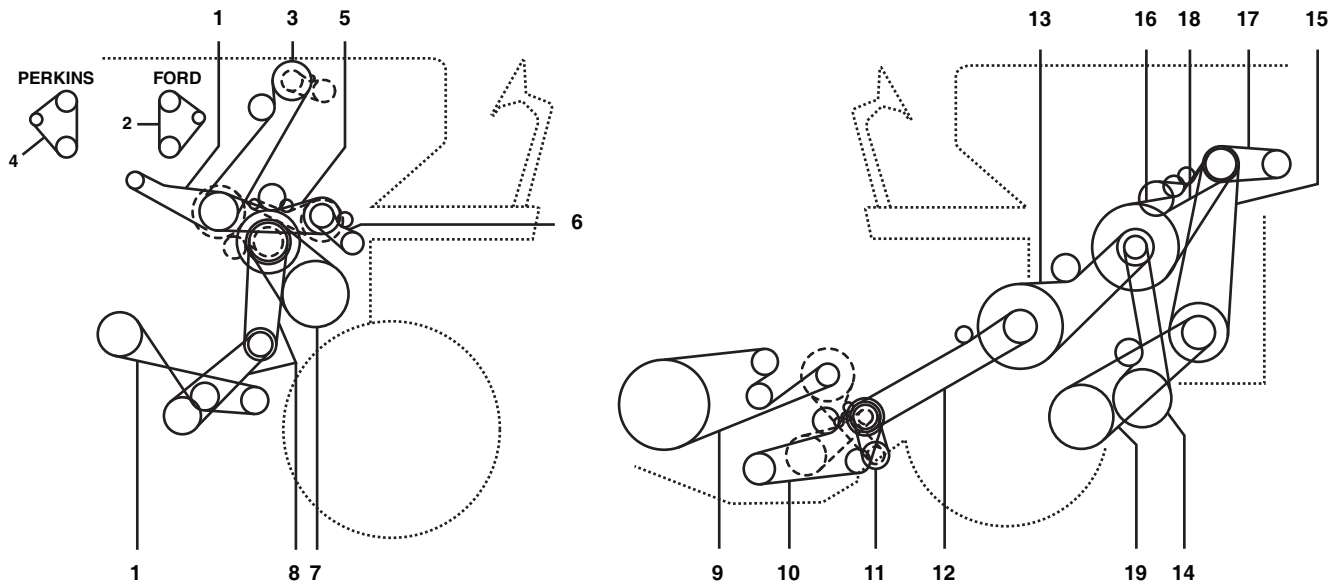

| Belt No. |  | No. of Belts | OEM  Part No. | PIX  Part No. |
|----------|---|--------------|--|--|
| 0 | Hydraulic Pump Drive | 1 | 80398748 | A-80398748 |
| 0 | Hydraulic Pump Drive | 1 | 80350236 | A-80350236 |
| 1 | Reel Drive | 1 | 80333255 | A-80333255 |
| 2 | Knife Drive | 1 | 80337415 | A-80337415 |
| 3 | Reel Drive Variable Speed | 1 | 80334065 | A-80334065 |
| 4 | Sickle Knife Drive | 2 | 80362500 | A-80362500 |
| 5 | Drum Drive Variable Speed | 1 | 80336784 | A-80336784 |
| 6 | Hydraulic Pump Drive | 2 | 80335258 | A-80335258 |
| 7 | Main Shaft Drive | 1 | 80323646 | A-80323646 |
| 8 | Unloading System | 1 | 80333958 | A-80333958 |
| 9 | Drum Drive Variable Speed | 1 | 80336784 | A-80336784 |
| 9 | Drum Drive Variable Speed | 1 | 80355797 | A-80355797 |
| 12 | Elevator Drive Grain | 1 | 80230164 | A-80230164 |
| 12 | Elevator Drive Grain | 1 | 80353584 | A-80353584 |
| 13 | Rotary Screen Drive | 1 | 80354338 | A-80354338 |
| 14 | Tailings Elevator Drive | 1 | 80323413 | A-80323413 |
| 15 | Intermediate Reel - Knife | 1 | 80324391 | A-80324391 |
| 16 | Fan Drive | 1 | 80230059 | A-80230059 |
| 17 | Straw Walker - Eccentric | 1 | 80333347 | A-80333347 |
| 17 | Straw Walker - Eccentric | 1 | 80378672 | A-80378672 |
| 18 | Fan Drive Variable Speed | 1 | 80320935 | A-80320935 |
| 19 | Deutz Engine | 1 | 80336386 | A-80336386 |
| 19 | Ford Engine | 1 | 80371222 | A-80371222 |
| 19 | Deutz Engine | 1 | 80386155 | A-80386155 |





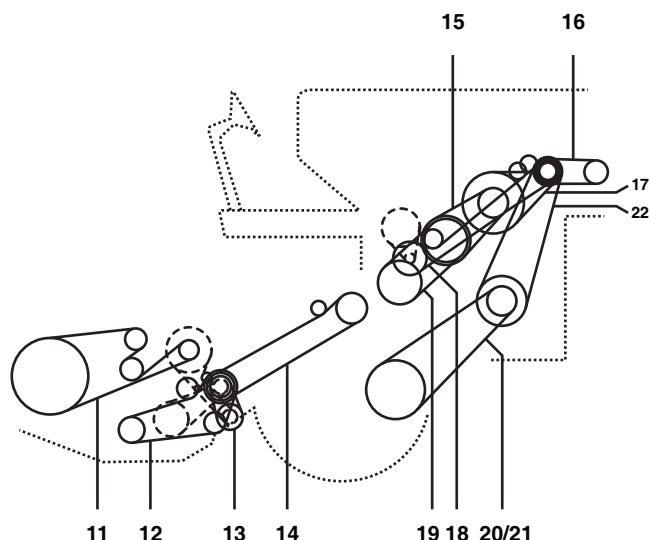
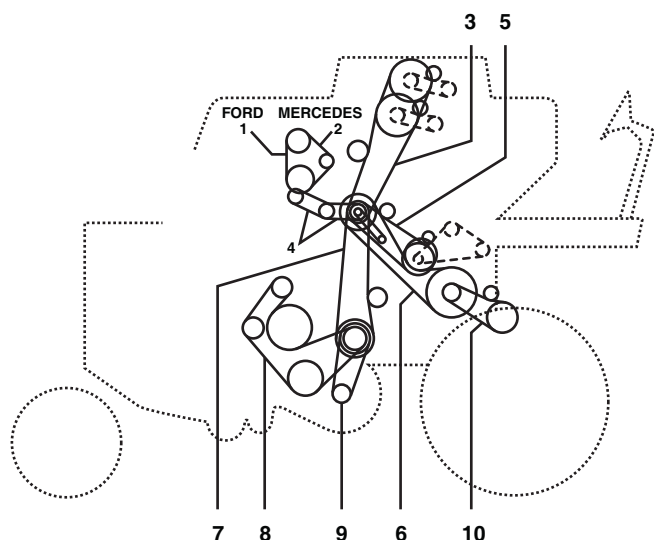

| Belt No. | | No. of Belts | OEM  Part No. | PIX  Part No. |
|----------|---|--------------|--|--|
| 1 | Straw Walker Drive | 2 | 80230108 | A-80230108 |
| 2 | Fan Drive (ford Engine) | 1 | 80371222 | A-80371222 |
| 3 | Elevator Drive Grain | 1 | 80230059 | A-80230059 |
| 3 | Elevator Drive Grain | 1 | 80230062 | A-80230062 |
| 5 | Tailings Elevator Drive | 1 | 80230057 | A-80230057 |
| 6 | Return Auger Drive | 1 | 80230041 | A-80230041 |
| 7 | Drum Drive Variable Speed | 1 | 80230078 | A-80230078 |
| 8 | Fan Drive Variable Speed | 2 | 80230056 | A-80230056 |
| 9 | Reel Drive | 1 | 80333255 | A-80333255 |
| 10 | Knife Drive | 1 | 80337415 | A-80337415 |
| 11 | Reel Drive Variable Speed | 1 | 80334065 | A-80334065 |
| 12 | Intermediate Shaft - Knife | 2 | 80643353 | A-80643353 |
| 13 | Straw Elevator Drive | 1 | 80230073 | A-80230073 |
| 14 | Eccentric Shaft Drive | 1 | 80230060 | A-80230060 |
| 15 | Traction Drive | 1 | 80230077 | A-80230077 |
| 16 | Beater Drive | 1 | 80230080 | A-80230080 |
| 17 | Hydraulic Pump Drive | 1 | 80230043 | A-80230043 |
| 18 | Unloading System | 1 | 80309364 | A-80309364 |
| 19 | Traction Drive (high Speed - Pulleydia 415mm) | 1 | 80230077 | A-80230077 |
| 19 | Traction Drive (low Speed - Pulley Dia 500mm) | 1 | 80354115 | A-80354115 |

NEW HOLLAND 1550

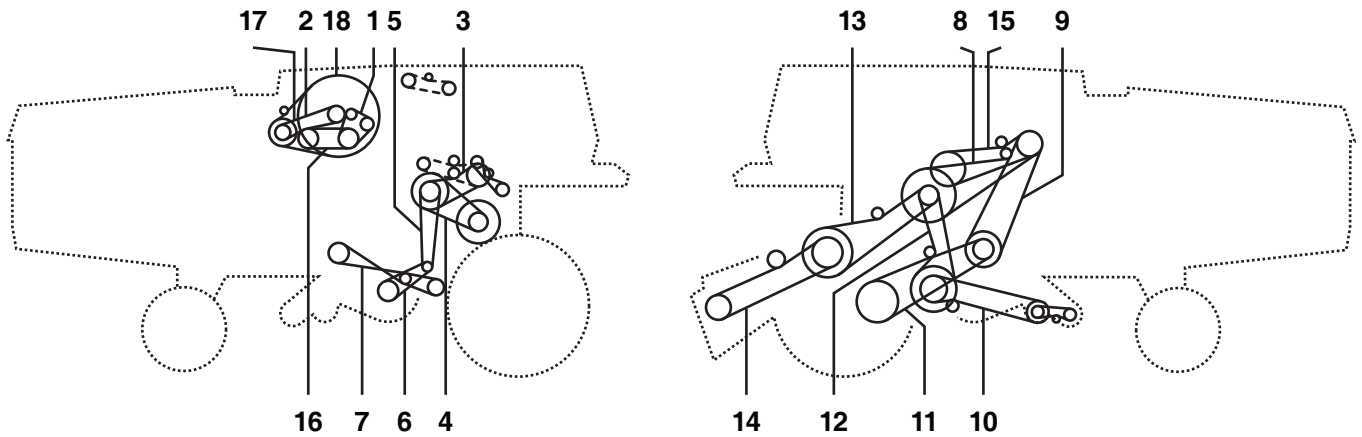





| Belt No. |  | No. of Belts | OEM  Part No. | PIX  Part No. |
|----------|---|--------------|--|--|
| 1 | Fan Drive Ford | 2 | 80364033 | A-80364033 |
| 2 | Fan Drive (mercedes) | 1 | 80230039 | A-80230039 |
| 3 | Grain Elevator Drive | 1 | 80230164 | A-80230164 |
| 4 | Rotary Screen Drive | 1 | 80354338 | A-80354338 |
| 5 | Tailings Elevator Drive | 1 | 80323413 | A-80323413 |
| 6 | Intermediate Drive: Reel And Knife | 1 | 80324391 | A-80324391 |
| 7 | Fan Vari - Drive | 1 | 80230059 | A-80230059 |
| 8 | Eccentric And Strawwalker Drive | 1 | 80333347 | A-80333347 |
| 9 | Fan Drive | 1 | 80320935 | A-80320935 |
| 10 | Grain Elevator Extension | 1 | 80353584 | A-80353584 |
| 11 | Reel Drive | 1 | 80333255 | A-80333255 |
| 12 | Knife Drive | 1 | 80337415 | A-80337415 |
| 13 | Reel Variator | 1 | 80334065 | A-80334065 |
| 14 | Intermediate Drive: Shaft And Knife | 2 | 80362500 | A-80362500 |
| 15 | Drum Variator | 1 | 80336784 | A-80336784 |
| 16 | Hydraulic Pump Drive | 2 | 80335258 | A-80335258 |
| 17 | Main Shaft Drive | 1 | 80323646 | A-80323646 |
| 18 | Unloading System | 1 | 80333958 | A-80333958 |
| 19 | Drum Vari - Drive | 1 | 80336784 | A-80336784 |
| 20 | Ground Speed For Pulley, Diameter 450 Mm | 1 | 80330441 | A-80330441 |
| 22 | Ground Speed Vari - Drive | 1 | 80330441 | A-80330441 |



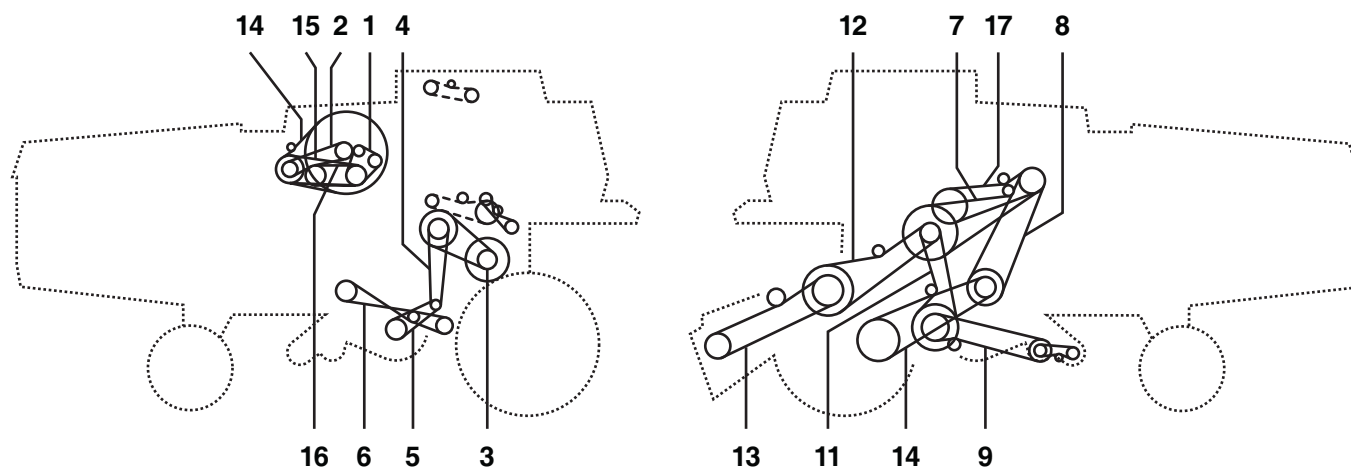



| Belt No. |  | No. of Belts | OEM  Part No. | PIX  Part No. |
|----------|---|--------------|--|--|
| 1 | Transmission (ford) | 1 | 80443634 | A-80443634 |
| 1 | Transmission (mercedes) | 1 | 80444045 | A-80444045 |
| 1 | Transmission Aifo (fiat) | 2 | 80443636 | A-80443636 |
| 2 | Hydraulic Pump Drive | 1 | 80393519 | A-80393519 |
| 3 | Grain Tank Unloading Auger Drive | 1 | 80422725 | A-80422725 |
| 4 | Drum Vari - Drive | 1 | 80336784 | A-80336784 |
| 5 | Fan Vari - Drive | 1 | 80230057 | A-80230057 |
| 6 | Fan Vari - Drive | 1 | 80395955 | A-80395955 |
| 7 | Eccentric And Straw Walker Drive | 1 | 80431784 | A-80431784 |
| 8 | Main Drive | 1 | 80422281 | A-80422281 |
| 8 | Main Drive | 1 | 80447031 | A-80447031 |
| 9 | Ground Speed Vari - Drive (upper) | 1 | 80356024 | A-80356024 |
| 10 | Elevator Drive | 1 | 80422731 | A-80422731 |
| 11 | Ground Speed Vari - Drive (lower), Standard Speed | 1 | 80230077 | A-80230077 |
| 11 | Ground Speed Vari - Drive (lower), Standard Speed | 1 | 80439129 | A-80439129 |
| 11 | Ground Speed Vari - Drive (lower), Low Speed | 1 | 80354115 | A-80354115 |
| 12 | Eccentric Shaft Drive | 1 | 80387469 | A-80387469 |
| 13 | Straw Elevator Drive | 1 | 66232 | A-66232 |
| 14 | Header Drive | 1 | 80330715 | A-80330715 |
| 15 | Intermediate Shaft Drive - Grain Tank, Bottom Auger | 1 | 80447041 | A-80447041 |
| 16 | Intermediate Shaft Drive, Fan & Rotary Dust Screen Drive | 1 | 80427456 | A-80427456 |
| 17 | Radiator Fan Drive | 1 | 80427455 | A-80427455 |
| 18 | Rotary Dust Screen Drive | 1 | 80422441 | A-80422441 |

NEW HOLLAND 8040

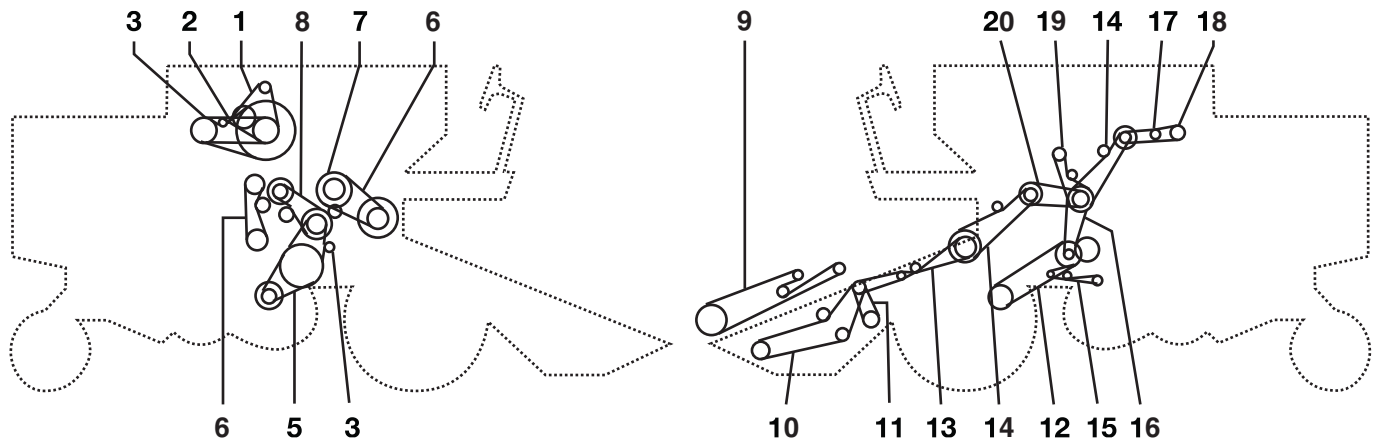



| Belt No. |  | No. of Belts | OEM  Part No. | PIX  Part No. |
|----------|---|--------------|--|--|
| 1 | Transmission (ford) | 1 | 80443634 | A-80443634 |
| 1 | Transmission (mercedes) | 1 | 80444045 | A-80444045 |
| 1 | Transmission Aifo (fiat) | 2 | 80443636 | A-80443636 |
| 2 | Radiator Fan Drive | 1 | 80427455 | A-80427455 |
| 3 | Drum Vari - Drive | 1 | 80336784 | A-80336784 |
| 4 | Fan Vari - Drive | 1 | 80230057 | A-80230057 |
| 5 | Fan Vari - Drive | 1 | 80395955 | A-80395955 |
| 6 | Eccentric And Straw Walker Drive | 1 | 80431784 | A-80431784 |
| 7 | Main Drive | 1 | 80422281 | A-80422281 |
| 7 | Main Drive | 1 | 80447031 | A-80447031 |
| 8 | Ground Speed Vari - Drive (upper) | 1 | 80356024 | A-80356024 |
| 9 | Elevator Drive | 1 | 80422731 | A-80422731 |
| 10 | Ground Speed Vari - Drive (lower), Standard Speed | 1 | 80230077 | A-80230077 |
| 10 | Ground Speed Vari - Drive (lower), Standard Speed | 1 | 80439129 | A-80439129 |
| 10 | Ground Speed Vari - Drive (lower), Low Speed | 1 | 80354115 | A-80354115 |
| 11 | Eccentric Shaft Drive | 1 | 80387469 | A-80387469 |
| 12 | Straw Elevator Drive | 1 | 66232 | A-66232 |
| 12 | Reinforced Straw Elevator Drive | 1 | 80424563 | A-80424563 |
| 13 | Header Drive | 1 | 80330715 | A-80330715 |
| 13 | Header Drive - Reinforced Straw Elevator | 2 | 80643353 | A-80643353 |
| 14 | Rotary Dust Screen Drive | 1 | 80422441 | A-80422441 |
| 15 | Intermediate Shaft Drive, Fanand Rotary Dust Screen Drive | 1 | 80427456 | A-80427456 |
| 16 | Hydraulic Pump Drive | 1 | 80393519 | A-80393519 |
| 17 | Intermediate Shaft Drive - Grain Tank, Bottom Auger | 1 | 80230164 | A-80230164 |
| 17 | Intermediate Shaft Drive - Grain Tank, Bottom Auger | 1 | 80447041 | A-80447041 |





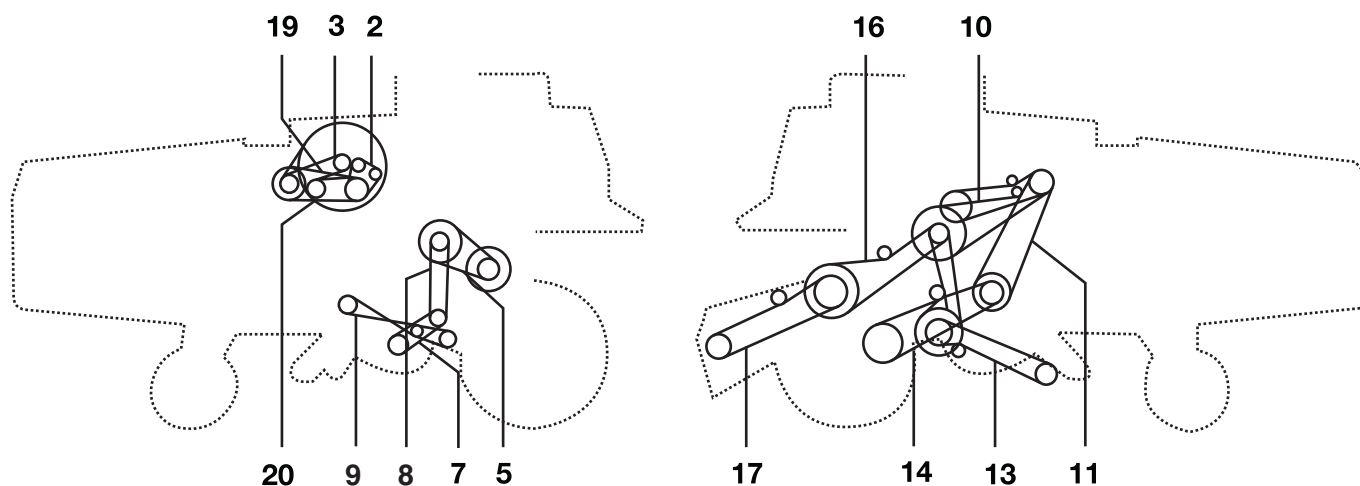

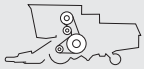
| Belt No. |  | No. of Belts | OEM  Part No. | PIX  Part No. |
|----------|---|--------------|--|--|
| 1 | Alternator And Waterpump Drive (mercedesengine) | 1 | 80421173 | A-80421173 |
| 1 | Alternator Drive (ford Engine 2704 Et) | 1 | 80371222 | A-80371222 |
| 1 | Ford Engine | 1 | 81540767 | A-81540767 |
| 2 | Intermediate Shaft - Screen Drive | 1 | 80399058 | A-80399058 |
| 3 | Dust Filter | 1 | 80381489 | A-80381489 |
| 3 | Dust Screen Drive | 1 | 80457643 | A-80457643 |
| 4 | Tailings Auger (superior) (grain) | 1 | 80387469 | A-80387469 |
| 5 | Fan Drive | 1 | 80378989 | A-80378989 |
| 6 | Fan Drive | 1 | 80388280 | A-80388280 |
| 7 | Drum Drive Variable Speed | 1 | 80336784 | A-80336784 |
| 8 | Beater Drive (201 = 4406001 - 4411999) | 2 | 80396750 | A-80396750 |
| 8 | Beater Drive (30 = 4322001 - ...) | 2 | 80437033 | A-80437033 |
| 9 | Intermediate Shaft - Beater Drive | 1 | 80395955 | A-80395955 |
| 10 | Beater Drum Drive | 1 | 80451481 | A-80451481 |
| 10 | Main Shaft Drive | 1 | 80397298 | A-80397298 |
| 11 | Drum Drive Variable Speed | 1 | 80397297 | A-80397297 |
| 12 | Hydraulic Pump Drive | 1 | 80230151 | A-80230151 |
| 13 | Intermediate Shaft - Screen Drive | 1 | 80389245 | A-80389245 |
| 14 | Ground Speed Drive (reduced Speed) | 1 | 80420606 | A-80420606 |
| 14 | Ground Speed Drive (standard Speed) | 1 | 80230076 | A-80230076 |
| 15 | Straw Walker Drive | 1 | 80605529 | A-80605529 |
| 16 | Intermediate Shaft - Auger (grain) | 1 | 80410896 | A-80410896 |
| 17 | Straw Elevator Drive | 1 | 80393326 | A-80393326 |
| 18 | Intermediate Shaft - Cutter Drive | 2 | 80643353 | A-80643353 |
| 19 | Ground Speed Drive | 1 | 80230077 | A-80230077 |
| 19 | Speed Variator drive | 1 | 80356024 | A-80356024 |

NEW HOLLAND 8055

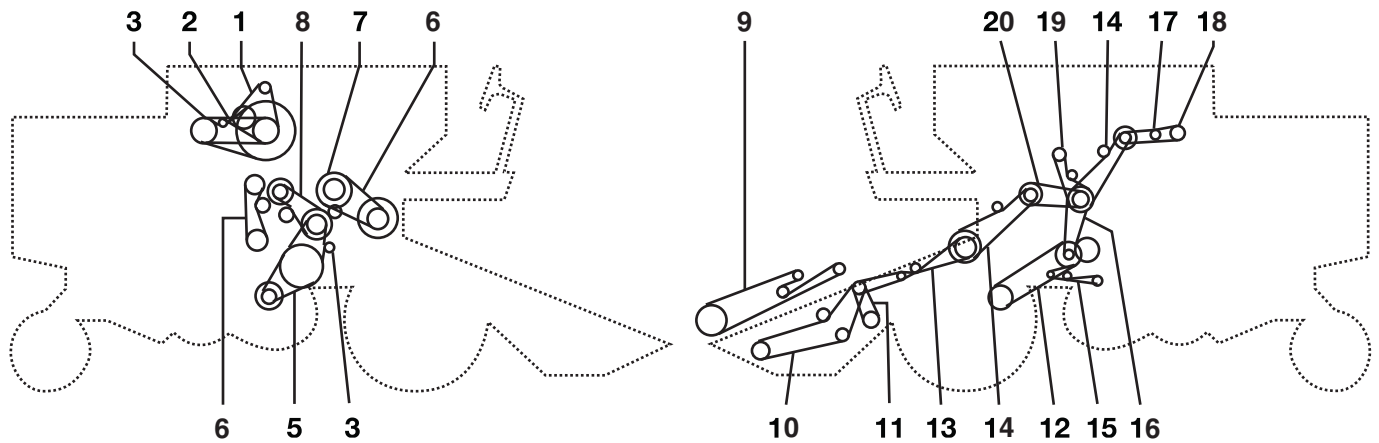



| Belt No. |  | No. of Belts | OEM  Part No. | PIX  Part No. |
|----------|---|--------------|--|--|
| 2 | Alternator And Waterpump Drive (ford Engine) | 1 | 80443634 | A-80443634 |
| 2 | Alternator And Waterpump Drive (mercedes Engine) | 1 | 80444045 | A-80444045 |
| 3 | Fan Drive | 1 | 80427455 | A-80427455 |
| 5 | Drum Drive Variable Speed | 1 | 80336784 | A-80336784 |
| 7 | Fan Drive | 1 | 80230057 | A-80230057 |
| 8 | Fan Drive | 1 | 80395955 | A-80395955 |
| 9 | Straw Walker Drive | 1 | 80431784 | A-80431784 |
| 10 | Beater Drive | 1 | 80447031 | A-80447031 |
| 13 | Elevator Bottom Auger (grain) | 1 | 80422731 | A-80422731 |
| 15 | Eccentric Shaft Drive | 1 | 80387469 | A-80387469 |
| 16 | Straw Elevator Drive | 1 | 80066232 | A-80066232 |
| 16 | Straw Elevator Drive | 1 | 80424563 | A-80424563 |
| 17 | Header Drive | 2 | 80394426 | A-80394426 |
| 18 | Rotary Dust Screen Drive | 1 | 80422441 | A-80422441 |
| 19 | Intermediate Shaft - Dust Screen Drive | 1 | 80427456 | A-80427456 |
| 20 | Hydraulic Pump Drive | 1 | 80393519 | A-80393519 |
| 21 | Intermediate Shaft | 1 | 80447041 | A-80447041 |





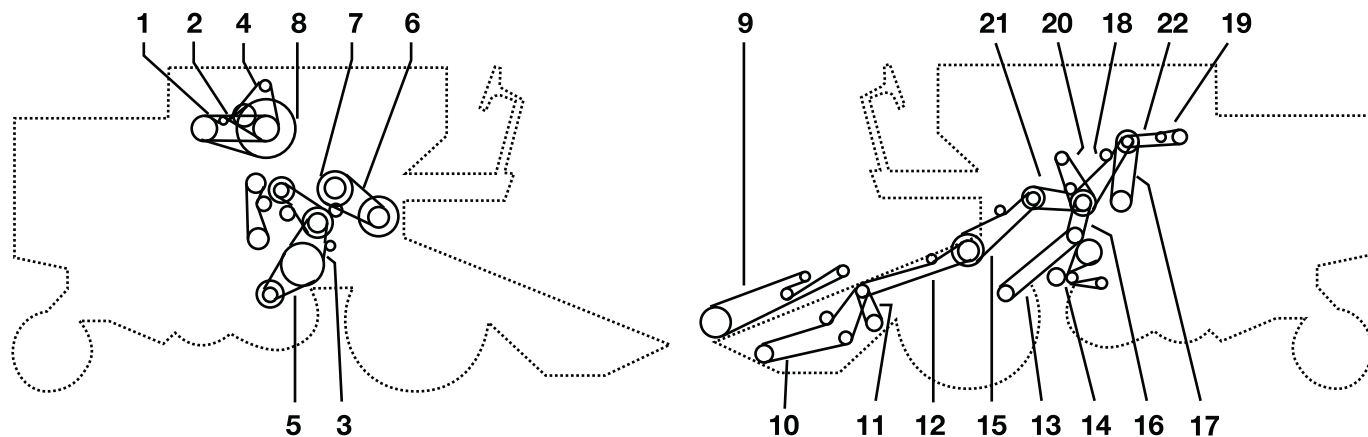

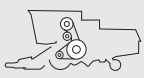
| Belt No. |  | No. of Belts | OEM  Part No. | PIX  Part No. |
|----------|---|--------------|--|--|
| 1 | Alternator And Waterpump Drive (mercedesengine) | 1 | 80421173 | A-80421173 |
| 1 | Alternator Drive (ford Engine 2704 Et) | 1 | 80371222 | A-80371222 |
| 1 | Ford Engine | 1 | 81540767 | A-81540767 |
| 1 | Only 8060 Aifo-fiat Engine | 1 | 80432802 | A-80432802 |
| 2 | Intermediate Shaft - Screen Drive | 1 | 80399058 | A-80399058 |
| 3 | Dust Filter | 1 | 80381489 | A-80381489 |
| 3 | Dust Screen Drive | 1 | 80457643 | A-80457643 |
| 4 | Tailings Auger (superior) (grain) | 1 | 80387469 | A-80387469 |
| 5 | Fan Drive | 1 | 80378989 | A-80378989 |
| 6 | Fan Drive | 1 | 80388280 | A-80388280 |
| 7 | Drum Drive Variable Speed | 1 | 80336784 | A-80336784 |
| 8 | Beater Drive (330 = 4313001 - 4321999) | 2 | 80396750 | A-80396750 |
| 8 | Beater Drive (40 = 4322001 - ...) | 2 | 80437033 | A-80437033 |
| 9 | Intermediate Shaft - Beater Drive | 1 | 80395955 | A-80395955 |
| 10 | Beater Drum Drive | 1 | 80387454 | A-80387454 |
| 11 | Drum Drive Variable Speed | 1 | 80397297 | A-80397297 |
| 12 | Hydraulic Pump Drive | 1 | 80230151 | A-80230151 |
| 13 | Intermediate Shaft - Screen Drive | 1 | 80389245 | A-80389245 |
| 14 | Ground Speed Drive (reduced Speed) | 1 | 80420606 | A-80420606 |
| 14 | Ground Speed Drive (standard Speed) | 1 | 80230076 | A-80230076 |
| 15 | Straw Walker Drive | 1 | 80605529 | A-80605529 |
| 16 | Intermediate Shaft - Auger (grain) | 1 | 80410896 | A-80410896 |
| 17 | Straw Elevator Drive | 1 | 80393326 | A-80393326 |
| 18 | Intermediate Shaft - Cutter Drive | 2 | 80394426 | A-80394426 |
| 19 | Ground Speed Drive | 1 | 80230077 | A-80230077 |
| 19 | Speed Variator drive | 1 | 80356024 | A-80356024 |

NEW HOLLAND 8070

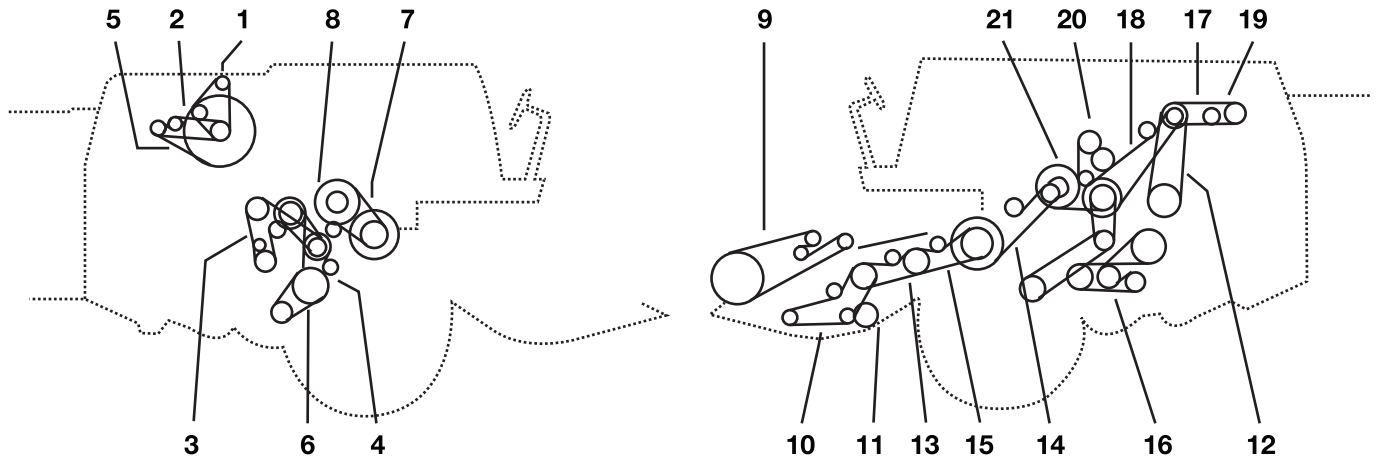



| Belt No. |  | No. of Belts | OEM  Part No. | PIX  Part No. |
|----------|---|--------------|--|--|
| 1 | Reel Drive | 1 | 80333255 | A-80333255 |
| 2 | Knife Drive | 1 | 80337415 | A-80337415 |
| 3 | Reel Drive Variable Speed | 1 | 80334065 | A-80334065 |
| 4 | Header Drive | 2 | 80394426 | A-80394426 |
| 5 | Ground Speed Variator Drive | 1 | 80356025 | A-80356025 |
| 6 | Ground Speed Drive (reduced Speed) - Pulley Diameter 350 Mm | 1 | 80417643 | A-80417643 |
| 6 | Ground Speed Drive (standard Speed) - Pulley Diameter 404 Mm | 1 | 80321559 | A-80321559 |
| 7 | Straw Elevator Drive | 1 | 80393326 | A-80393326 |
| 8 | Straw Walker Drive | 1 | 80605529 | A-80605529 |
| 9 | Hydrostatic Pump Drive | 1 | 80411543 | A-80411543 |
| 10 | Drum Drive Variable Speed | 1 | 80391650 | A-80391650 |
| 11 | Intermediate Shaft | 1 | 80389245 | A-80389245 |
| 12 | Intermediate Shaft - Auger (grain) | 1 | 80410896 | A-80410896 |
| 13 | Re-thresher Drive | 1 | 80387454 | A-80387454 |
| 13 | Re-thresher Drive | 1 | 80451481 | A-80451481 |
| 14 | Hydraulic Pump Drive | 1 | 80230151 | A-80230151 |
| 15 | Fan Drive | 1 | 80384397 | A-80384397 |
| 16 | Dust Screen Drive | 1 | 80381489 | A-80381489 |
| 17 | Fan Drive | 1 | 80378989 | A-80378989 |
| 18 | Tailings Elevator Drive | 1 | 80387469 | A-80387469 |
| 19 | Alternator Drive (mercedes Engine Om 352a) | 1 | 80421173 | A-80421173 |
| 19 | Alternator Drive (ford Engine 2704 Et) | 1 | 80371222 | A-80371222 |
| 20 | Fan Drive Variable Speed | 1 | 80388280 | A-80388280 |
| 21 | Drum Drive Variable Speed | 1 | 80387460 | A-80387460 |
| 22 | Countershaft Drive | 2 | 80396750 | A-80396750 |
| 22 | Countershaft Drive | 2 | 80437033 | A-80437033 |
| 23 | Variator Drive | 1 | 80395955 | A-80395955 |



| Belt No. |  | No. of Belts | OEM  Part No. | PIX  Part No. |
|----------|---|--------------|--|--|
| 1 | Reel Drive | 1 | 80333255 | A-80333255 |
| 2 | Knife Drive | 1 | 80337415 | A-80337415 |
| 3 | Reel Drive Variable Speed | 1 | 80334065 | A-80334065 |
| 4 | Hydrostatic Pump Drive | 1 | 80411543 | A-80411543 |
| 5 | Header Drive | 2 | 80387931 | A-80387931 |
| 6 | Straw Elevator Drive | 1 | 80393326 | A-80393326 |
| 7 | Header Drive | 2 | 80391143 | A-80391143 |
| 8 | Straw Walker Drive | 1 | 80605529 | A-80605529 |
| 9 | Hydraulic Pump Drive | 1 | 80230151 | A-80230151 |
| 10 | Drum Drive Variable Speed | 1 | 80391650 | A-80391650 |
| 11 | Intermediate Shaft | 1 | 80389245 | A-80389245 |
| 12 | Intermediate Shaft - Auger (grain) | 1 | 80410896 | A-80410896 |
| 13 | Re-thresher Drive | 1 | 80387454 | A-80387454 |
| 13 | Re-thresher Drive | 1 | 80451481 | A-80451481 |
| 14 | Alternator Drive (mercedes Engine Om 401) | 1 | 80393519 | A-80393519 |
| 14 | Alternator Drive (mercedes Engine Om 421) | 1 | 80432642 | A-80432642 |
| 15 | Fan Drive (mercedes Engine Om 401) | 1 | 80384397 | A-80384397 |
| 16 | Dust Screen Drive | 1 | 80381489 | A-80381489 |
| 17 | Fan Drive | 1 | 80378989 | A-80378989 |
| 18 | Tailings Elevator Drive | 1 | 80387469 | A-80387469 |
| 20 | Fan Drive Variable Speed | 1 | 80388280 | A-80388280 |
| 21 | Drum Drive Variable Speed | 1 | 80387460 | A-80387460 |
| 22 | Countershaft Drive | 2 | 80396750 | A-80396750 |
| 22 | Countershaft Drive | 2 | 80437033 | A-80437033 |
| 23 | Variator Drive | 1 | 80395955 | A-80395955 |

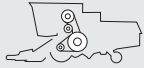

NEW HOLLAND 9630 - 9640 - 9645

| Belt No. |  | No. of Belts | OEM  Part No. | PIX  Part No. |
|----------|---|--------------|--|--|
| 1 | Main Drive | 1 | 84017742 | A-84017742 |
| 2 | Drive | 1 | 84026761 | A-84026761 |
| 3 | Fan Drive | 1 | 84012975 | A-84012975 |
| 4 | Alternator Drive | 1 | 84022807 | A-84022807 |
| 5 | Compressor Drive | 1 | 89835815 | A-89835815 |
| 5 | Compressor Drive | 1 | 80747177 | A-80747177 |



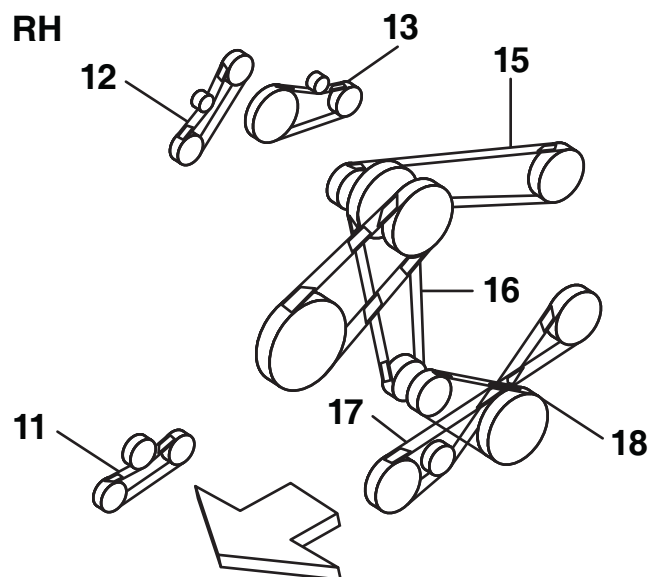
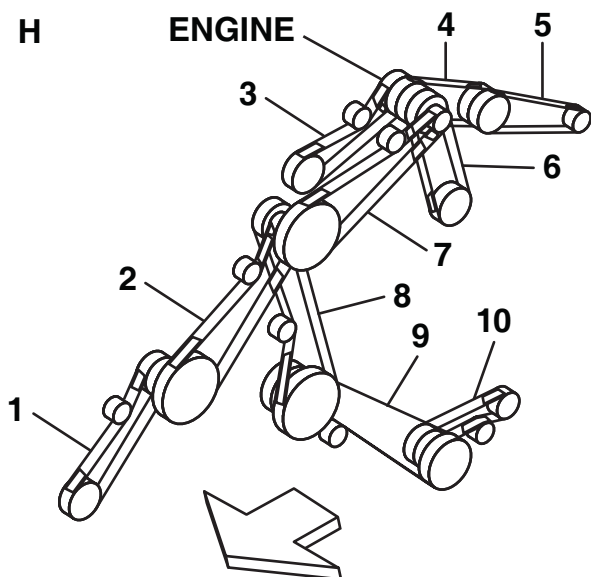

NEW HOLLAND AL 59 - HILLSIDE



| Belt No. | | No. of Belts | OEM  Part No. | PIX  Part No. |
|----------|---|--------------|--|--|
| 1 | - | 1 | 84001336 | A-84001336 |
| 2 | - | 1 | 80424563 | A-80424563 |
| 3 | - | 1 | 89838606 | A-89838606 |
| 4 | - | 1 | 84004444 | A-84004444 |
| 4 | - | 1 | 84019041 | A-84019041 |
| 5 | - | 1 | 84022152 | A-84022152 |
| 5 | - | 1 | 84041070 | A-84041070 |
| 5 | - | 1 | 84041069 | A-84041069 |
| 6 | - | 1 | 89818873 | A-89818873 |
| 7 | - | 1 | 89817374 | A-89817374 |
| 8 | - | 1 | 80387469 | A-80387469 |
| 9 | - | 1 | 80422731 | A-80422731 |
| 14 | - | 1 | 80336784 | A-80336784 |
| 15 | - | 1 | 89837412 | A-89837412 |
| 16 | - | 1 | 89515075 | A-89515075 |
| 17 | - | 1 | 80431784 | A-80431784 |
| 18 | - | 1 | 89515076 | A-89515076 |

NEW HOLLAND CL 560 - HILLSIDE



| Belt No. |  | No. of Belts | OEM  Part No. | PIX  Part No. |
|----------|---|--------------|--|--|
| 1 | Alternator, Waterpump And Air Compressor Drive | 1 | 84817638 | A-84817638 |
| 2 | Drum Drive | 1 | 84072772 | A-84072772 |
| 2 | Drum Drive | 1 | 84072815 | A-84072815 |
| 2 | Hydraulic Pump Drive | 1 | 80427456 | A-80427456 |
| 5 | Rotary Screen Drive And Fan | 1 | 84817626 | A-84817626 |
| 9 | Grass Seed Equipment | 1 | 84452153 | A-84452153 |
| 10 | Straw Walker Drive | 1 | 84073276 | A-84073276 |
| 12 | Fan Vari Drive | 1 | 84073979 | A-84073979 |
| 13 | Grain Elevator Bottom Drive | 1 | 80422731 | A-80422731 |
| 17 | Blow Off System Air Compressor | 2 | 84061465 | A-84061465 |
| 19 | Hydrostatic Pump Drive | 1 | 84607713 | A-84607713 |
| 26 | Rotary Screen Drive And Fan | 1 | 84989965 | A-84989965 |
| 27 | Unloading Auger | 1 | 84991836 | A-84991836 |
| 28 | Main Drive | 1 | 84993120 | A-84993120 |
| 29 | Shaker Shoe Drive | 1 | 84817635 | A-84817635 |
| 35 | Header Drive | 1 | 84464057 | A-84464057 |
| 36 | Grass Seed Equipment | 1 | 84452112 | A-84452112 |
| 36 | Rotary Separator Drive And shaft | 1 | 84073933 | A-84073933 |
| 38 | Drum Variator | 1 | 84035748 | A-84035748 |
| 51 | Chopper Drive | 1 | 84076421 | A-84076421 |
| 52 | Chopper Drive | 1 | 84075955 | A-84075955 |

NEW HOLLAND CL 6060

| Belt No. |  | No. of Belts | OEM  Part No. | PIX  Part No. |
|----------|---|--------------|--|--|
| 1 | Drum Drive | 1 | 84072772 | A-84072772 |
| 1 | Drum Drive (low Drum Speed) | 1 | 84072815 | A-84072815 |
| 2 | Hydraulic Pump Drive | 1 | 427456 | A-427456 |
| 2 | Unloading Auger Drive | 1 | 84462590 | A-84462590 |
| 3 | Rotary Screen And Fan Drive | 1 | 84817626 | A-84817626 |
| 6 | Kit For Long Conveyor | 1 | 84971217 | A-84971217 |
| 9 | Grass Seed Equipment | 1 | 84452153 | A-84452153 |
| 10 | Straw Walker Drive | 1 | 87521887 | A-87521887 |
| 12 | Fan Vari Drive | 1 | 84073979 | A-84073979 |
| 13 | Grain Elevator Bottom Drive | 1 | 80422731 | A-80422731 |
| 15 | Header Drive | 1 | 84464057 | A-84464057 |
| 19 | Hydrostatic Pump Drive | 1 | 87721960 | A-87721960 |
| 23 | Straw Elevator Drive | 1 | 89835120 | A-89835120 |
| 28 | Main Drive | 1 | 84993120 | A-84993120 |
| 29 | Shaker Shoe Drive | 1 | 84817635 | A-84817635 |
| 36 | Grass Seed Equipment | 1 | 84452112 | A-84452112 |
| 36 | Rotary Separator Drive and Shaft | 1 | 84073933 | A-84073933 |
| 38 | Drum Variator | 1 | 84035748 | A-84035748 |
| 51 | Chopper Drive | 1 | 84076421 | A-84076421 |
| 52 | Chopper Drive | 1 | 84075955 | A-84075955 |

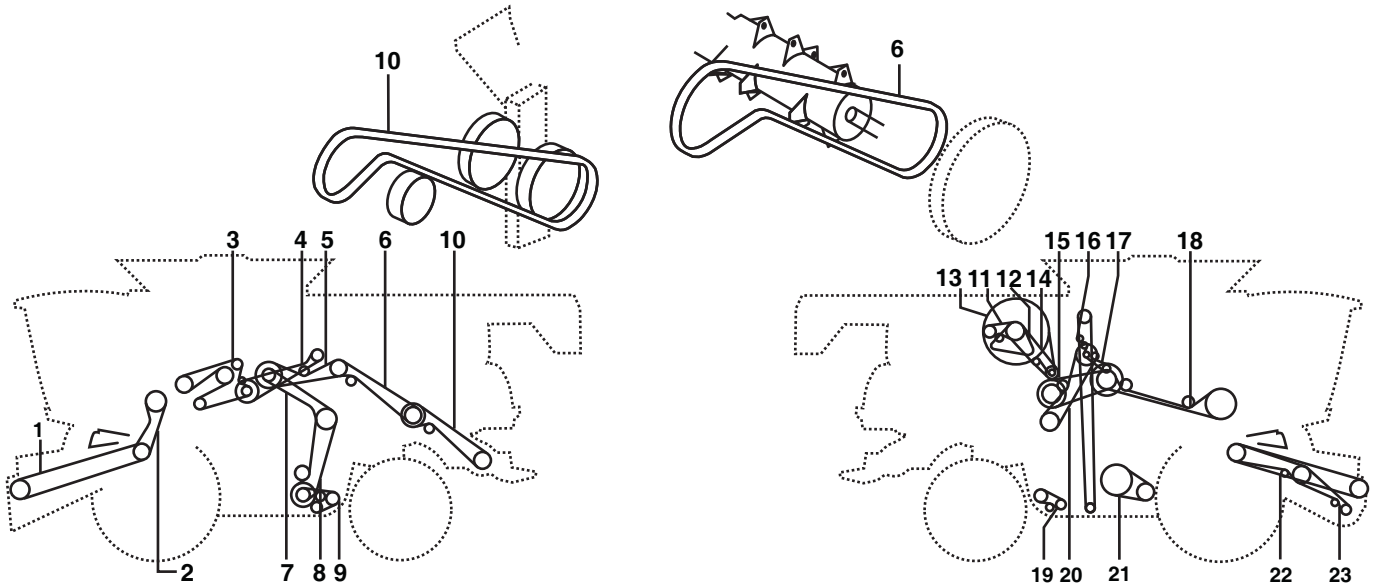

NEW HOLLAND CR 960



| Belt No. |  | No. of Belts | OEM  Part No. | PIX  Part No. |
|----------|---|--------------|--|--|
| 2 | Straw Elevator Drive | 1 | 84072421 | A-84072421 |
| 4 | Unloading Auger | 1 | 87011585 | A-87011585 |
| 5 | Main Drive | 1 | 87580097 | A-87580097 |
| 6 | Chopper Drive | 1 | 84320963 | A-84320963 |
| 7 | Beater Drive | 1 | 87580099 | A-87580099 |
| 8 | Beater Drive | 1 | 86566287 | A-86566287 |
| 9 | Shaker Shoe Drive - Self-levelling | 2 | 84056913 | A-84056913 |
| 10 | Chopper Drive | 1 | 84320963 | A-84320963 |
| 11 | Air Compressor | 1 | 99472776 | A-99472776 |
| 12 | Drive, Rotary Screen And Fan | 2 | 445930 | A-445930 |
| 13 | Drive, Rotary Screen And Fan | 1 | 84057085 | A-84057085 |
| 14 | Alternator Drive | 1 | 747177 | A-747177 |
| 15 | Rotor Drive, High Speed | 1 | 86592734 | A-86592734 |
| 15 | Rotor Variator | 1 | 87053804 | A-87053804 |
| 18 | Feeder Drive | 1 | 86589482 | A-86589482 |
| 19 | Tailings Elevators, Bottom Auger And (right Hand) | 2 | 84058339 | A-84058339 |
| 20 | Grain Elevator, Drive | 1 | 87319821 | A-87319821 |
| 21 | Cleaning Fan, Fixed Shoe, Sieve Fixed | 1 | 919739 | A-919739 |
| 22 | Fan Vari-drive | 1 | 84817627 | A-84817627 |

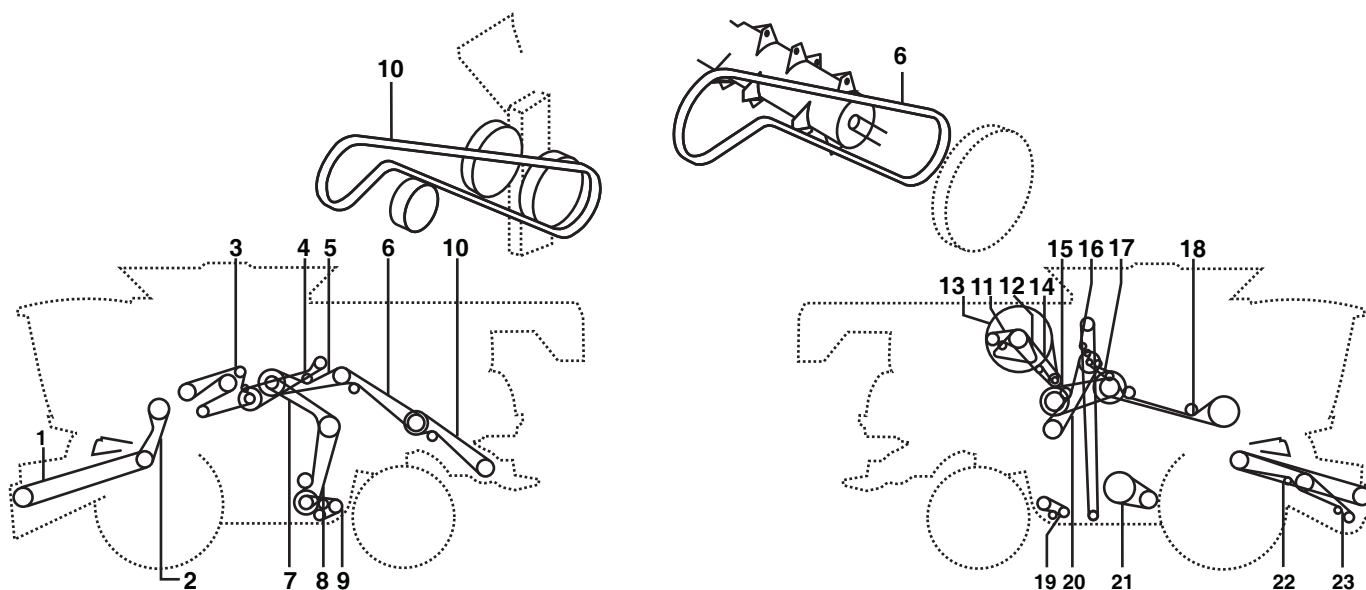

NEW HOLLAND CR 980

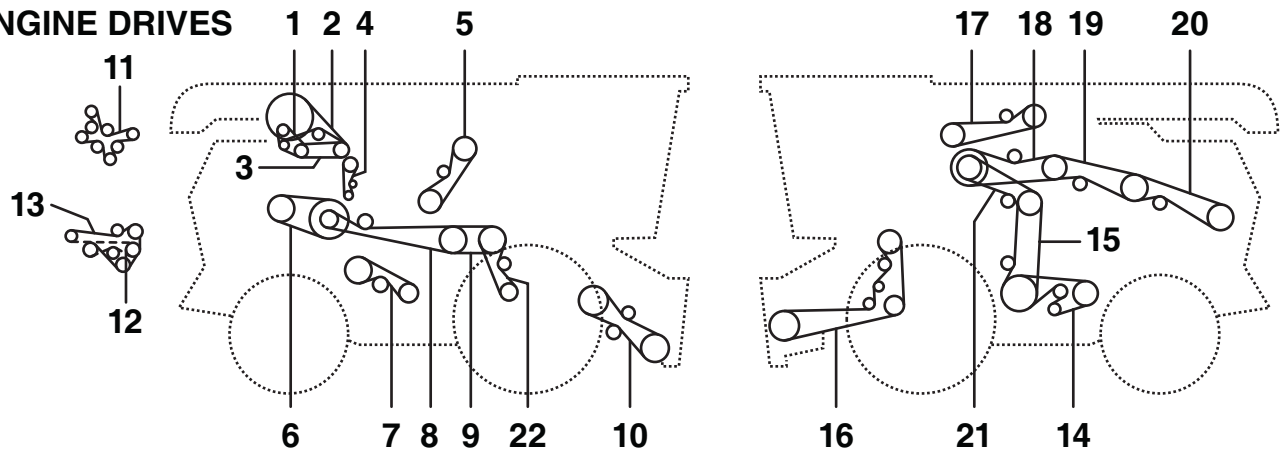

| Belt No. |  | No. of Belts | OEM  Part No. | PIX  Part No. |
|----------|---|--------------|--|--|
| 2 | Straw Elevator Drive | 1 | 84072421 | A-84072421 |
| 4 | Unloading Auger | 1 | 87011585 | A-87011585 |
| 5 | Main Drive | 1 | 87580097 | A-87580097 |
| 6 | Chopper Drive | 1 | 84320963 | A-84320963 |
| 7 | Beater Drive | 1 | 87580099 | A-87580099 |
| 8 | Beater Drive | 1 | 86566287 | A-86566287 |
| 9 | Shaker Shoe Drive - Self-levelling | 2 | 84056913 | A-84056913 |
| 10 | Chopper Drive | 1 | 84320963 | A-84320963 |
| 11 | Air Conditioning Drive | 1 | 504020489 | A-504020489 |
| 12 | Drive, Rotary Screen And Fan | 2 | 445930 | A-445930 |
| 13 | Drive, Rotary Screen And Fan | 1 | 84057085 | A-84057085 |
| 14 | Alternator Drive | 1 | 747177 | A-747177 |
| 15 | Rotor Drive, High Speed | 1 | 86563175 | A-86563175 |
| 15 | Rotor Variator | 1 | 87053803 | A-87053803 |
| 18 | Feeder Drive | 1 | 86589482 | A-86589482 |
| 19 | Tailings Elevators, Bottom Auger And (right Hand) | 2 | 84058339 | A-84058339 |
| 20 | Grain Elevator, Drive | 1 | 87319821 | A-87319821 |
| 21 | Cleaning Fan, Fixed Shoe, Sieve Fixed | 1 | 919739 | A-919739 |
| 22 | Fan Vari-drive | 1 | 84817627 | A-84817627 |

ENGINE DRIVES





| Belt No. |  | No. of Belts | OEM  Part No. | PIX  Part No. |
|----------|---|--------------|--|--|
| 1 | Fan Drive | 1 | 918062 | A-918062 |
| 2 | Rotary Screen (upper) | 1 | 87664428 | A-87664428 |
| 3 | Rotary Screen (lower) | 1 | 87556830 | A-87556830 |
| 4 | Dust Screen Aspirator (Serial Following Nr 01/09/2012) | 1 | 84422774 | A-84422774 |
| 5 | Grain Elevator Drive | 1 | 84137965 | A-84137965 |
| 6 | Drum Variator (prior To Ser Nr 29/07/2012) | 1 | 87676816 | A-87676816 |
| 7 | Bottom Auger And Tailings Elevator (right Hand) | 1 | 84332132 | A-84332132 |
| 8 | Header Drive (corn And Bean Only) | 1 | 84352808 | A-84352808 |
| 8 | Header Drive (grain Only) | 1 | 84352807 | A-84352807 |
| 8 | Header Drive, Variable (corn And Bean Only) (Prior to Ser Nr 27/02/2012) | 1 | 84298895 | A-84298895 |
| 9 | Feeder Drive Variator (corn And Bean Only) | 1 | 87583907 | A-87583907 |
| 10 | Feeder Drive (right Hand) | 1 | 84254480 | A-84254480 |
| 11 | Engine Belt (f2c, Fe613a, A017 Anda018) | 1 | 84292639 | A-84292639 |
| 14 | Shaker Shoe Drive, Self Levelling | 1 | 84353448 | A-84353448 |
| 15 | Beater, Intermediate Drive | 1 | 87315599 | A-87315599 |
| 16 | Feeder Drive (left Hand) | 1 | 84274885 | A-84274885 |
| 16 | Feeder Drive (left Hand) | 1 | 87545653 | A-87545653 |
| 17 | Unloader Auger Drive | 1 | 87011585 | A-87011585 |
| 18 | Main Drive | 2 | 87545651 | A-87545651 |
| 19 | Chopper, Intermediate Drive (front) | 1 | 87580100 | A-87580100 |
| 19 | Chopper, Intermediate Drive (for Chopper Ready Drive) | 1 | 87580100 | A-87580100 |
| 20 | Chopper, Intermediate Drive (rear) | 1 | 87580100 | A-87580100 |
| 21 | Beater Drive | 1 | 87546479 | A-87546479 |

NEW HOLLAND CR 8080

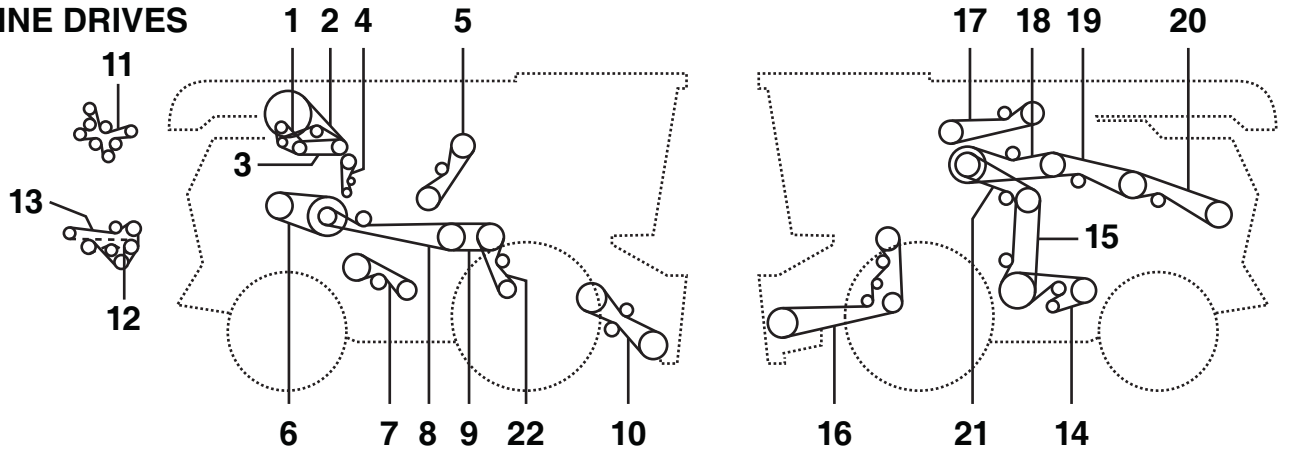
ENGINE DRIVES



| Belt No. |  | No. of Belts | OEM  Part No. | PIX  Part No. |
|----------|---|--------------|--|--|
| 1 | Fan Drive | 1 | 87284244 | A-87284244 |
| 2 | Rotary Screen (upper) | 1 | 87664428 | A-87664428 |
| 3 | Rotary Screen (lower) | 1 | 747177 | A-747177 |
| 4 | Dust Screen Aspirator (serial Following Nr 01/09/2012) | 1 | 84422774 | A-84422774 |
| 5 | Grain Elevator Drive | 1 | 84137965 | A-84137965 |
| 6 | Drum Variator (prior to Ser Nr 29/07/2012) | 1 | 87676816 | A-87676816 |
| 7 | Bottom Auger And Tailings Elevator (right Hand) | 1 | 84332132 | A-84332132 |
| 8 | Header Drive (corn And Bean Only) | 1 | 84352808 | A-84352808 |
| 8 | Header Drive (grain Only) | 1 | 84352807 | A-84352807 |
| 8 | Header Drive, Variable (corn And Bean Only) (prior To Ser Nr 27/02/2012) | 1 | 84298895 | A-84298895 |
| 9 | Feeder Drive Variator (corn And Bean Only) | 1 | 87583907 | A-87583907 |
| 10 | Feeder Drive (right Hand) | 1 | 84254480 | A-84254480 |
| 11 | Engine Belt (f2c, Fe613a, A017 And A018) | 1 | 84292639 | A-84292639 |
| 12 | Air Conditioning Belt (f3e E0684s E913 And F3a Fe613a A002) | 1 | 84238514 | A-84238514 |
| 13 | Alternator, Waterpump Belt (f3e E0684s E913 And F3a Fe613a A002) | 1 | 84238513 | A-84238513 |
| 14 | Shaker Shoe Drive, Self Levelling | 1 | 84353448 | A-84353448 |
| 15 | Beater, Intermediate Drive | 1 | 87315599 | A-87315599 |
| 16 | Feeder Drive (left Hand) | 1 | 84274885 | A-84274885 |
| 16 | Feeder Drive (left Hand) | 1 | 87545653 | A-87545653 |
| 17 | Unloader Auger Drive | 1 | 87011585 | A-87011585 |
| 18 | Main Drive | 1 | 87545651 | A-87545651 |
| 19 | Chopper, Intermediate Drive (front) | 1 | 87580100 | A-87580100 |
| 19 | Chopper, Intermediate Drive (for Chopper Ready Drive) | 1 | 87580100 | A-87580100 |
| 20 | Chopper, Intermediate Drive (rear) | 1 | 87580100 | A-87580100 |
| 21 | Beater Drive | 1 | 87546479 | A-87546479 |

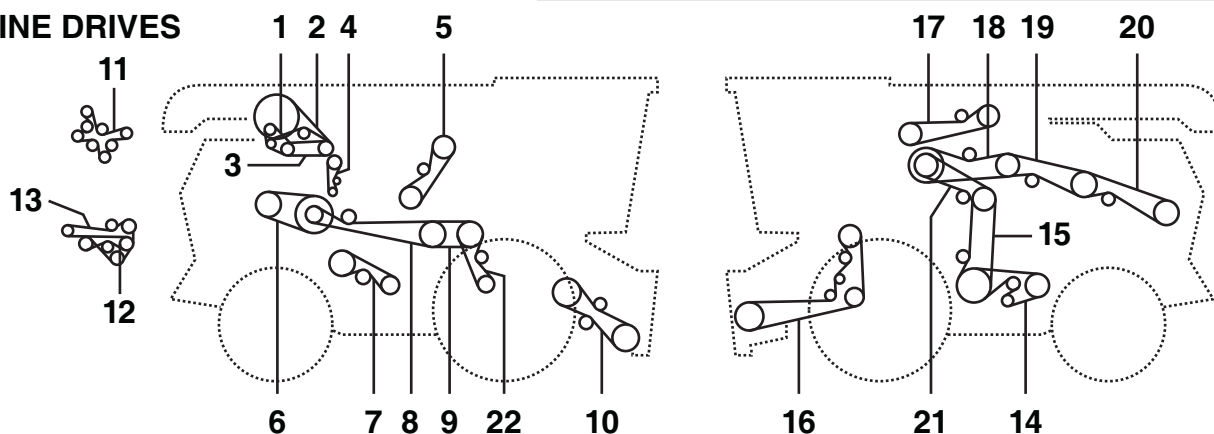

GINE DRIVES



| Belt No. |  | No. of Belts | OEM  Part No. | PIX  Part No. |
|----------|---|--------------|--|--|
| 1 | Fan Drive | 1 | 87284244 | A-87284244 |
| 2 | Rotary Screen (upper) | 1 | 87664428 | A-87664428 |
| 3 | Rotary Screen (lower) | 1 | 747177 | A-747177 |
| 4 | Dust Screen Aspirator (serial Following Nr 01/09/2012) | 1 | 84422774 | A-84422774 |
| 5 | Grain Elevator Drive | 1 | 84137965 | A-84137965 |
| 6 | Drum Variator (prior To Ser Nr 29/07/2012) | 1 | 87540195 | A-87540195 |
| 6 | Drum Variator (following Ser Nr 29/07/2012) | 1 | 84491658 | A-84491658 |
| 7 | Bottom Auger And Tailings Elevator (right Hand) | 1 | 84332132 | A-84332132 |
| 8 | Header Drive (corn And Bean Only) | 1 | 84352808 | A-84352808 |
| 8 | Header Drive (grain Only) | 1 | 84352807 | A-84352807 |
| 8 | Header Drive, Variable (corn And Bean Only) (prior to Ser Nr 27/02/2012) | 1 | 84298895 | A-84298895 |
| 8 | Header Drive (advanced Stone Protect) | 1 | 84298895 | A-84298895 |
| 9 | Feeder Drive Variator (corn And Bean Only) | 1 | 87583907 | A-87583907 |
| 9 | Feeder Drive Variator (advanced Stone Protect) | 1 | 84398996 | A-84398996 |
| 10 | Feeder Drive (right Hand) | 1 | 84254480 | A-84254480 |
| 11 | Engine Belt (f2c, Fe613a, A017 Anda018) | 1 | 84292639 | A-84292639 |
| 12 | Air Conditioning Belt (f3e E0684s E913 And F3a Fe613a A002) | 1 | 84238514 | A-84238514 |
| 13 | Alternator, Waterpump Belt (f3e E0684s E913 And F3a Fe613a A002) | 1 | 84238513 | A-84238513 |
| 14 | Shaker Shoe Drive, Self Levelling | 1 | 84353448 | A-84353448 |
| 15 | Beater, Intermediate Drive | 1 | 87315599 | A-87315599 |
| 16 | Feeder Drive (left Hand) | 1 | 84274885 | A-84274885 |
| 16 | Feeder Drive (left Hand) | 1 | 87545653 | A-87545653 |
| 16 | Feeder Drive (advanced Stone Protect) | 1 | 84394081 | A-84394081 |
| 17 | Unloader Auger Drive | 1 | 87011585 | A-87011585 |
| 18 | Main Drive | 1 | 87545651 | A-87545651 |
| 19 | Chopper, Intermediate Drive (front) | 1 | 87557181 | A-87557181 |
| 19 | Chopper, Intermediate Drive (for Chopper Ready Drive) | 1 | 87580100 | A-87580100 |
| 20 | Chopper, Intermediate Drive (rear) | 1 | 84188121 | A-84188121 |
| 21 | Beater Drive | 1 | 87546479 | A-87546479 |
| 22 | Stone Trap Drive (low Speed) & Adv. stone Protect | 1 | 84398998 | A-84398998 |
| 23 | Stone Trap Drive (low Speed) & Adv. stone Protect | 1 | 84398997 | A-84398997 |

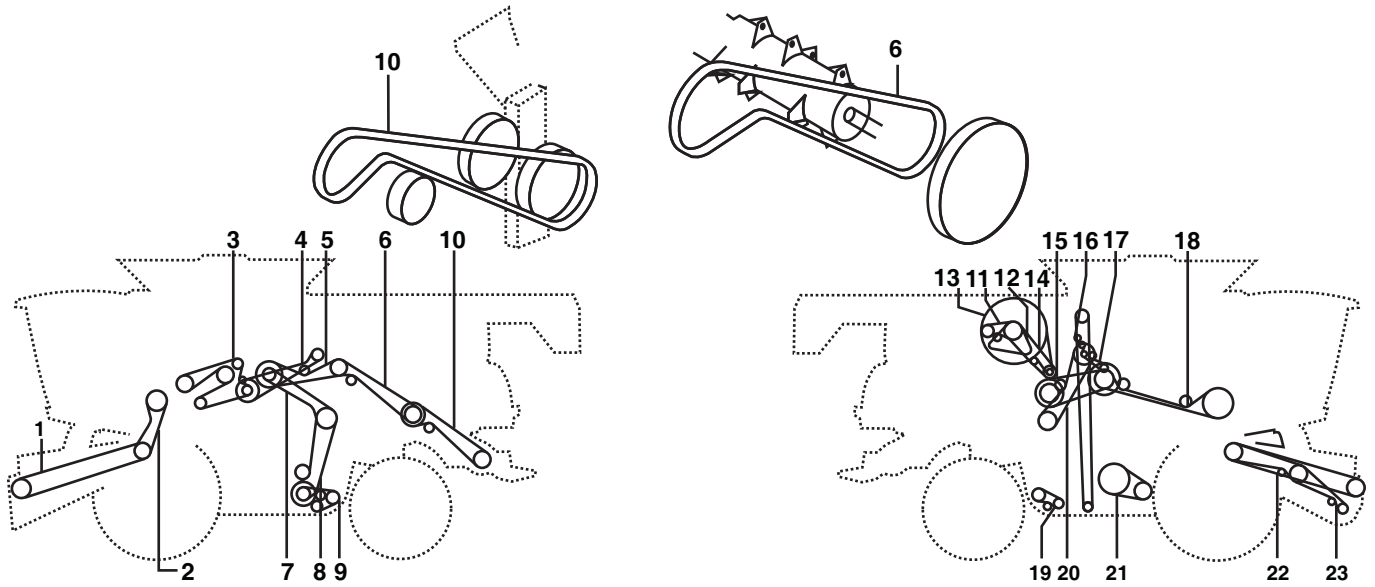

NEW HOLLAND CR 9060



| Belt No. |  | No. of Belts | OEM  Part No. | PIX  Part No. |
|----------|---|--------------|--|--|
| 1-2 | Straw Elevator Drive | 1 | 84072421 | A-84072421 |
| 4 | Unloading Auger | 1 | 87011585 | A-87011585 |
| 5 | Main Drive (bsn C575) | 1 | 86566606 | A-86566606 |
| 5 | Main Drive (asn D576) | 1 | 87580097 | A-87580097 |
| 6 | Chopper Drive (bsn C579) | 1 | 87031779 | A-87031779 |
| 6 | Chopper Drive (asn D580) | 1 | 87580100 | A-87580100 |
| 7 | Beater Drive (bsn C579) | 1 | 86566286 | A-86566286 |
| 7 | Beater Drive (asn D580) | 1 | 87580099 | A-87580099 |
| 8 | Beater Drive | 1 | 86566287 | A-86566287 |
| 9 | Shaker Shoe Drive - Self-levelling | 2 | 84056913 | A-84056913 |
| 10 | Chopper Drive (bsn C723) | 1 | 87526022 | A-87526022 |
| 10 | Chopper Drive (asn D724) | 1 | 84168012 | A-84168012 |
| 11 | Air Conditioner Unit: Mounting Group - W/o Heating | 1 | 84818007 | A-84818007 |
| 12 | Drive, Rotary Screen And Fan | 2 | 445930 | A-445930 |
| 13 | Drive, Rotary Screen And Fan (bsn C599) | 1 | 84057085 | A-84057085 |
| 13 | Drive, Rotary Screen And Fan (asn D600) | 1 | 87664428 | A-87664428 |
| 14 | Drive, Rotary Screen And Fan | 1 | 87556830 | A-87556830 |
| 15 | Rotor Variator | 1 | 87053804 | A-87053804 |
| 15 | Rotor Variator (reinforced Belt) | 1 | 87676816 | A-87676816 |
| 18 | Feeder Drive | 1 | 86589482 | A-86589482 |
| 19 | Tailings Elevators, Bottom Auger & (R/H) (BSN C675) | 2 | 84058339 | A-84058339 |
| 20 | Grain Elevator Drive | 1 | 87319821 | A-87319821 |
| 21 | Fan Vari-drive | 1 | 84817627 | A-84817627 |
| 24 | Grass Seed Equipment - Accessories | 1 | 84023277 | A-84023277 |

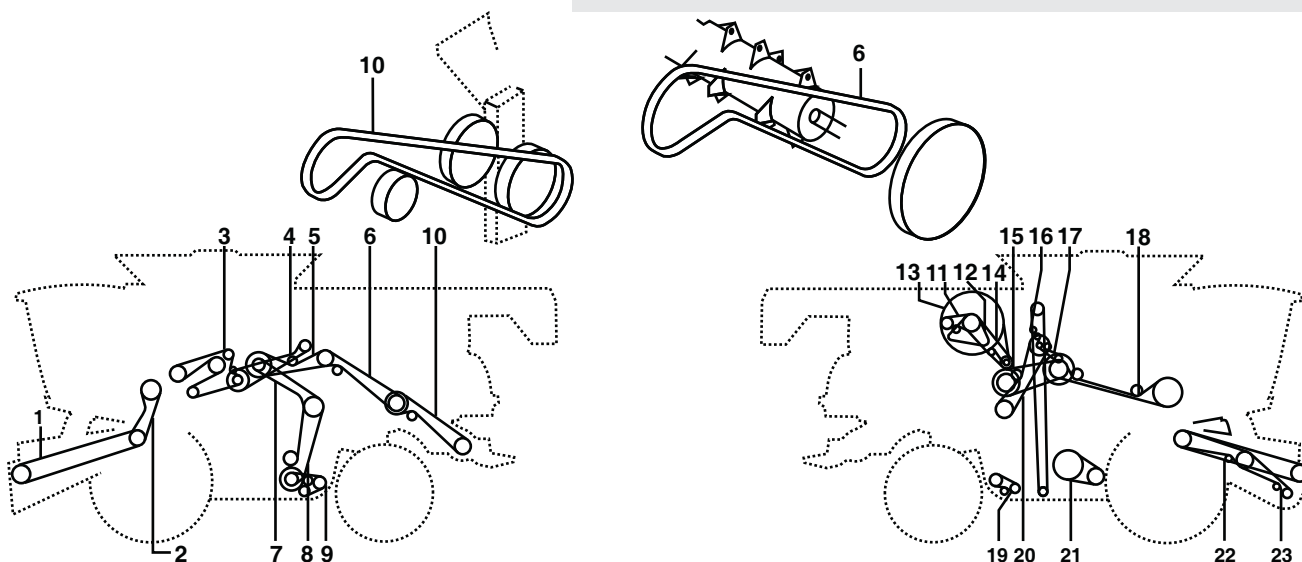

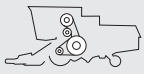
NEW HOLLAND CR 9060 ELEVATION



| Belt No. |  | No. of Belts | OEM  Part No. | PIX  Part No. |
|----------|---|--------------|--|--|
| 1-2 | Straw Elevator Drive | 1 | 84072421 | A-84072421 |
| 4 | Unloading Auger | 1 | 87011585 | A-87011585 |
| 5 | Main Drive (bsn C575) | 1 | 86566606 | A-86566606 |
| 5 | Main Drive (asn D576) | 1 | 87580097 | A-87580097 |
| 6 | Chopper Drive (bsn C579) | 1 | 87031779 | A-87031779 |
| 6 | Chopper Drive (asn D580) | 1 | 87580100 | A-87580100 |
| 7 | Beater Drive (bsn C579) | 1 | 86566286 | A-86566286 |
| 7 | Beater Drive (asn D580) | 1 | 87580099 | A-87580099 |
| 8 | Beater Drive | 1 | 86566287 | A-86566287 |
| 9 | Shaker Shoe Drive - Self-levelling | 2 | 84056913 | A-84056913 |
| 10 | Chopper Drive (bsn C723) | 1 | 87526022 | A-87526022 |
| 10 | Chopper Drive (asn D724) | 1 | 84168012 | A-84168012 |
| 11 | Air Conditioner Unit : Mounting Group (bsn C635) | 1 | 84818007 | A-84818007 |
| 11 | Air Conditioner Unit : Mounting Group (asn D604) | 1 | 84818008 | A-84818008 |
| 11 | Air Conditioner Unit : Mounting Group -W/o Heating | 1 | 84818007 | A-84818007 |
| 12 | Drive, Rotary Screen And Fan | 2 | 445930 | A-445930 |
| 13 | Drive, Rotary Screen And Fan(bsn C599) | 1 | 84057085 | A-84057085 |
| 13 | Drive, Rotary Screen And Fan(asn D600) | 1 | 87664428 | A-87664428 |
| 14 | Drive, Rotary Screen And Fan | 1 | 87556830 | A-87556830 |
| 15 | Rotor Variator | 1 | 87622201 | A-87622201 |
| 15 | Rotor Variator (reinforced Belt) | 1 | 87676816 | A-87676816 |
| 15 | Rotor Variator - Variable Feeder (bsn C659) | 1 | 86596143 | A-86596143 |
| 15 | Rotor Variator - Variable Feeder (asn D660) | 1 | 87583907 | A-87583907 |
| 18 | Feeder Drive | 1 | 86589482 | A-86589482 |
| 18 | Feeder Drive - Variable (bsn C659) | 1 | 86729163 | A-86729163 |
| 18 | Feeder Drive - Variable (asn D660) | 1 | 87583899 | A-87583899 |
| 19 | Tailings Elevators, Bottom Auger &(R/H)(bsn C675) | 2 | 84058339 | A-84058339 |
| 19 | Tailings Elevators, Bottom Auger &(R/H)(bsn F676719) | 2 | 84455757 | A-84455757 |
| 19 | Tailings Elevators, Bottom Auger &(R/H)(asn D720) | 2 | 84196804 | A-84196804 |
| 20 | Grain Elevator Drive | 1 | 87319821 | A-87319821 |
| 21 | Fan Vari-drive | 1 | 84817627 | A-84817627 |
| 24 | Grass Seed Equipment - Accessories | 1 | 84023277 | A-84023277 |
| 25 | Hydraulic Fan Drive | 1 | 87636309 | A-87636309 |

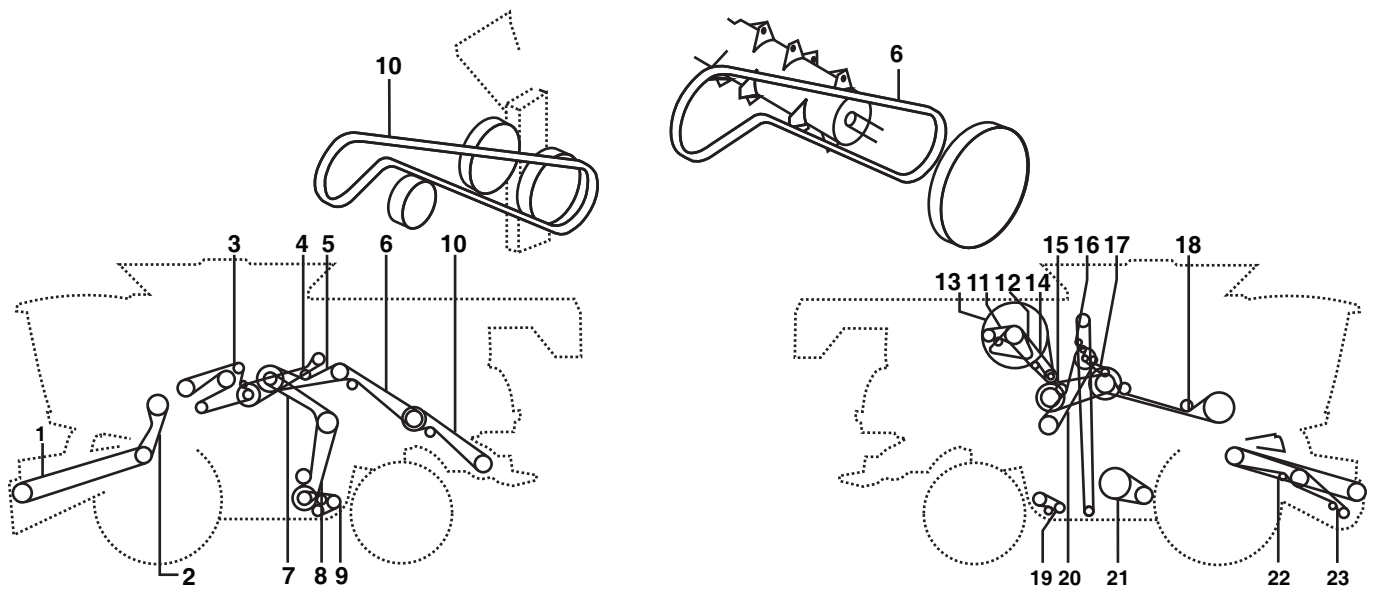

NEW HOLLAND CR 9070 ELEVATION



| Belt No. |  | No. of Belts | OEM  Part No. | PIX  Part No. |
|----------|---|--------------|--|--|
| 1-2 | Straw Elevator Drive | 1 | 87545653 | A-87545653 |
| 4 | Unloading Auger | 1 | 87011585 | A-87011585 |
| 5 | Main Drive | 1 | 87545651 | A-87545651 |
| 6 | Chopper Drive (bsn C579) | 1 | 87031779 | A-87031779 |
| 6 | Chopper Drive (asn D580) | 1 | 87580100 | A-87580100 |
| 7 | Beater Drive | 1 | 87546479 | A-87546479 |
| 8 | Beater Drive | 1 | 87315599 | A-87315599 |
| 9 | Shaker Shoe Drive - Self-levelling | 2 | 87325684 | A-87325684 |
| 10 | Chopper Drive (bsn C723) | 1 | 87526022 | A-87526022 |
| 10 | Chopper Drive (asn D724) | 1 | 84168012 | A-84168012 |
| 11 | Air Conditioner Unit : Mounting Group (bsn C635) | 1 | 84818007 | A-84818007 |
| 11 | Air Conditioner Unit : Mounting Group (asn D604) | 1 | 84818008 | A-84818008 |
| 12 | Drive, Rotary Screen And Fan | 2 | 747177 | A-747177 |
| 13 | Drive, Rotary Screen And Fan (bsn C599) | 1 | 84057085 | A-84057085 |
| 13 | Drive, Rotary Screen And Fan (asn D600) | 1 | 87664428 | A-87664428 |
| 14 | Drive, Rotary Screen And Fan | 2 | 87284244 | A-87284244 |
| 15 | Rotor Variator | 1 | 87622201 | A-87622201 |
| 15 | Rotor Variator (reinforced Belt) | 1 | 87676816 | A-87676816 |
| 15 | Rotor Variator - Variable Feeder (bsn C659) | 1 | 86596143 | A-86596143 |
| 15 | Rotor Variator - Variable Feeder (asn D660) | 1 | 87583907 | A-87583907 |
| 18 | Feeder Drive | 1 | 86589482 | A-86589482 |
| 18 | Feeder Drive - Variable (bsn C659) | 1 | 86729163 | A-86729163 |
| 18 | Feeder Drive - Variable (asn D660) | 1 | 87583899 | A-87583899 |
| 19 | Tailings Elevators, Bottom Auger & R/H (BSN C675) | 2 | 84058339 | A-84058339 |
| 19 | Tailings Elevators, Bottom Auger & R/H (BSN F676719) | 2 | 84455757 | A-84455757 |
| 19 | Tailings Elevators, Bottom Auger & R/H (ASN D720) | 2 | 84196804 | A-84196804 |
| 20 | Grain Elevator Drive | 1 | 87319821 | A-87319821 |
| 21 | Fan Vari-drive | 1 | 84817627 | A-84817627 |
| 24 | Grass Seed Equipment - Accessories | 1 | 84023277 | A-84023277 |
| 25 | Hydraulic Fan Drive | 1 | 87636309 | A-87636309 |

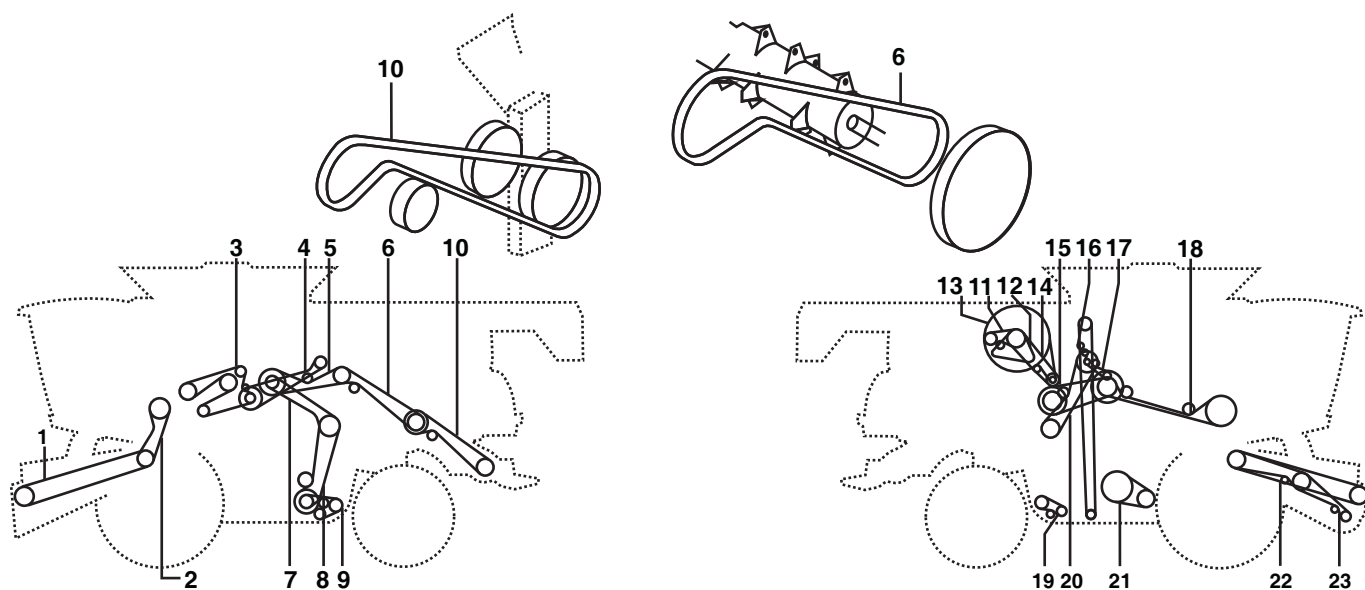

NEW HOLLAND CR 9080



| Belt No. |  | No. of Belts | OEM  Part No. | PIX  Part No. |
|----------|---|--------------|--|--|
| 1-2 | Straw Elevator Drive | 1 | 84072421 | A-84072421 |
| 4 | Unloading Auger | 1 | 87011585 | A-87011585 |
| 5 | Main Drive (bsn C575) | 1 | 86566606 | A-86566606 |
| 5 | Main Drive (asn D576) | 1 | 87580097 | A-87580097 |
| 6 | Chopper Drive (bsn C579) | 1 | 87031779 | A-87031779 |
| 6 | Chopper Drive (asn D580) | 1 | 87580100 | A-87580100 |
| 7 | Beater Drive (bsn C579) | 1 | 86566286 | A-86566286 |
| 7 | Beater Drive (asn D580) | 1 | 87580099 | A-87580099 |
| 8 | Beater Drive | 1 | 86566287 | A-86566287 |
| 9 | Shaker Shoe Drive - Self-levelling | 2 | 84056913 | A-84056913 |
| 10 | Chopper Drive (bsn C723) | 1 | 87526022 | A-87526022 |
| 10 | Chopper Drive (asn D724) | 1 | 84168012 | A-84168012 |
| 11 | Air Conditioner Unit : Mounting Group - W/o Heating | 1 | 84818007 | A-84818007 |
| 12 | Drive, Rotary Screen And Fan | 2 | 87284244 | A-87284244 |
| 13 | Drive, Rotary Screen And Fan(bsn C599) | 1 | 84057085 | A-84057085 |
| 13 | Drive, Rotary Screen And Fan(asn D600) | 1 | 87664428 | A-87664428 |
| 14 | Drive, Rotary Screen And Fan | 1 | 87556830 | A-87556830 |
| 15 | Rotor Variator | 1 | 87053803 | A-87053803 |
| 15 | Rotor Variator (reinforced Belt) | 1 | 87540195 | A-87540195 |
| 18 | Feeder Drive | 1 | 86589482 | A-86589482 |
| 19 | Tailings Elevators, Bottom Auger & R/H (BSN C675) | 2 | 84058339 | A-84058339 |
| 20 | Grain Elevator Drive | 1 | 87319821 | A-87319821 |
| 21 | Fan Vari-drive | 1 | 84817627 | A-84817627 |
| 24 | Grass Seed Equipment - Accessories | 1 | 84023277 | A-84023277 |
| 25 | Hydraulic Fan Drive | 1 | 87636309 | A-87636309 |

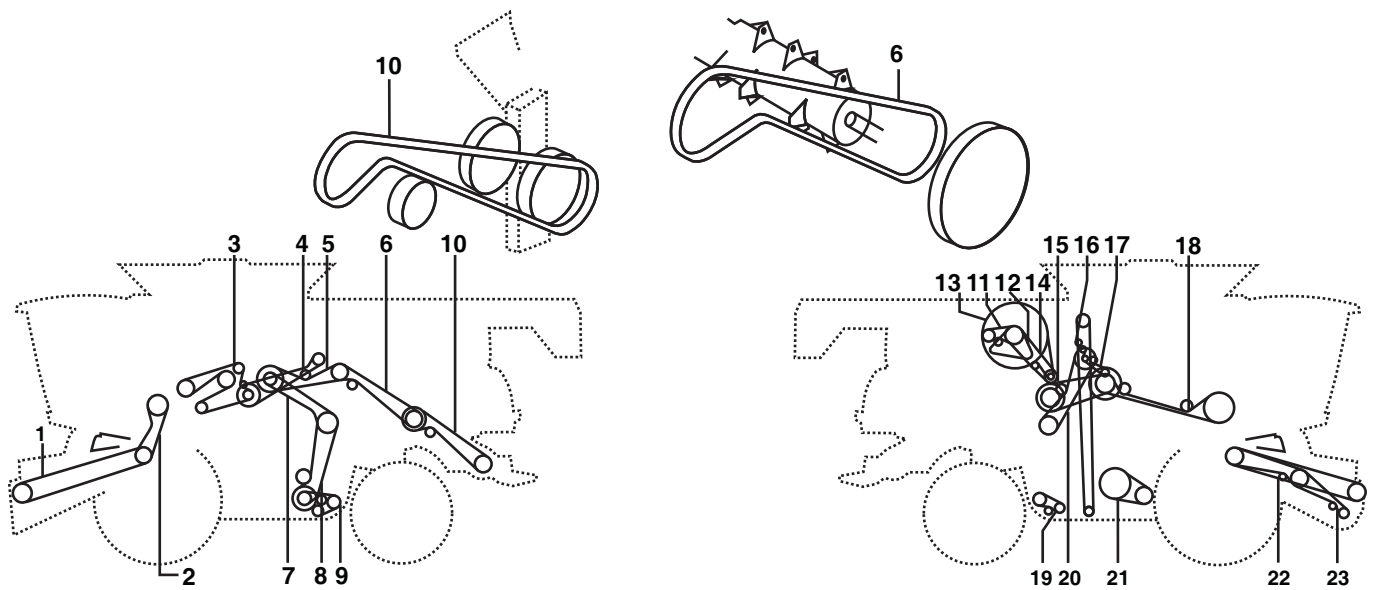

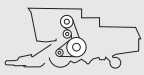
NEW HOLLAND CR 9080 ELEVATION



| Belt No. |  | No. of Belts | OEM  Part No. | PIX  Part No. |
|----------|---|--------------|--|--|
| 1-2 | Straw Elevator Drive | 1 | 87545653 | A-87545653 |
| 4 | Unloading Auger | 1 | 87011585 | A-87011585 |
| 5 | Main Drive | 1 | 87545651 | A-87545651 |
| 6 | Chopper Drive (bsn C579) | 1 | 87031779 | A-87031779 |
| 6 | Chopper Drive (asn D580) | 1 | 87580100 | A-87580100 |
| 7 | Beater Drive | 1 | 87546479 | A-87546479 |
| 8 | Beater Drive | 1 | 87315599 | A-87315599 |
| 9 | Shaker Shoe Drive - Self-levelling | 2 | 87325684 | A-87325684 |
| 10 | Chopper Drive (bsn C723) | 1 | 87526022 | A-87526022 |
| 10 | Chopper Drive (asn D724) | 1 | 84168012 | A-84168012 |
| 11 | Air Conditioner Unit : Mounting Group | 1 | 84818008 | A-84818008 |
| 12 | Drive, Rotary Screen And Fan | 2 | 9513136 | A-9513136 |
| 13 | Drive, Rotary Screen And Fan | 2 | 87284244 | A-87284244 |
| 14 | Drive, Rotary Screen And Fan | 2 | 87284244 | A-87284244 |
| 15 | Rotor Variator (reinforced Belt) (asn D660) | 1 | 87540195 | A-87540195 |
| 15 | Rotor Variator - Variable Feeder (bsn C659) | 1 | 86596143 | A-86596143 |
| 15 | Rotor Variator - Variable Feeder (asn D660) | 1 | 87583907 | A-87583907 |
| 18 | Feeder Drive | 1 | 87741240 | A-87741240 |
| 18 | Feeder Drive - Variable (bsn C659) | 1 | 86729163 | A-86729163 |
| 18 | Feeder Drive - Variable (asn D660) | 1 | 87583899 | A-87583899 |
| 19 | Tailings Elevators, Bottom Auger & R/H (BSN C675) | 2 | 84058339 | A-84058339 |
| 19 | Tailings Elevators, Bottom Auger & R/H (BSN F676719) | 2 | 84455757 | A-84455757 |
| 19 | Tailings Elevators, Bottom Auger & R/H (ASN D720) | 2 | 84196804 | A-84196804 |
| 20 | Grain Elevator Drive | 1 | 84137965 | A-84137965 |
| 21 | Fan Vari-drive | 1 | 84817627 | A-84817627 |
| 24 | Grass Seed Equipment - Accessories | 1 | 84023277 | A-84023277 |
| 25 | Hydraulic Fan Drive | 1 | 87636309 | A-87636309 |

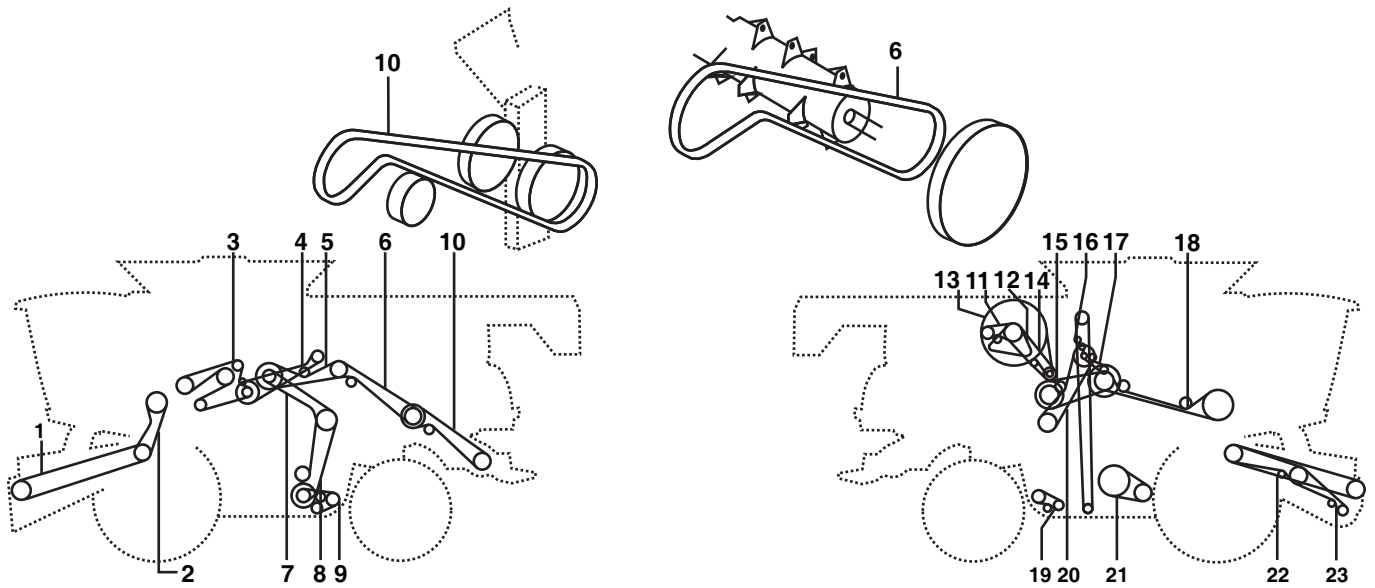

NEW HOLLAND CR 9090 ELEVATION



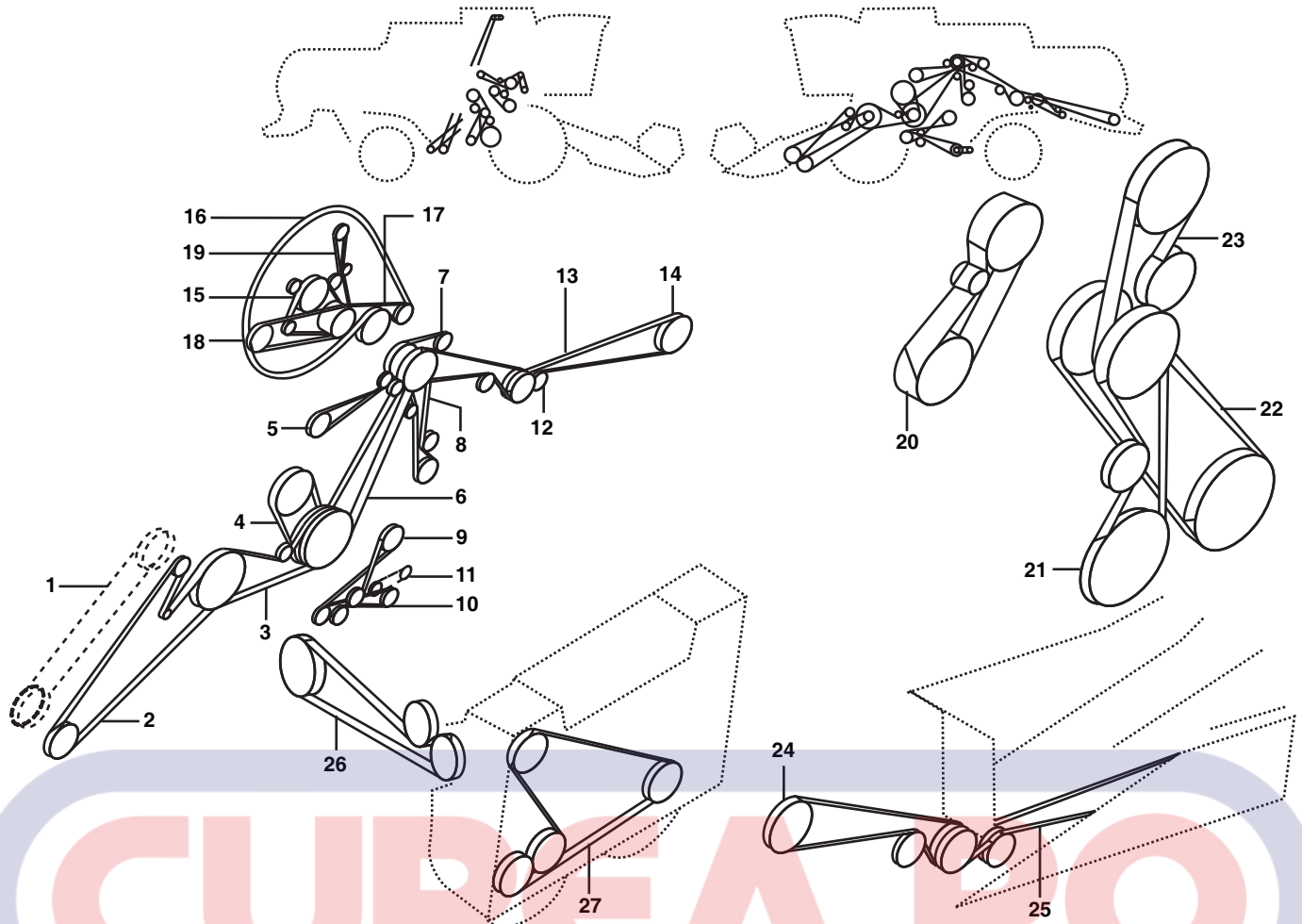

| Belt No. | | No. of Belts | OEM  Part No. | PIX  Part No. |
|----------|---|--------------|--|--|
| 1-2 | Straw Elevator Drive | 1 | 87545653 | A-87545653 |
| 4 | Unloading Auger | 1 | 87011585 | A-87011585 |
| 5 | Main Drive | 1 | 87545651 | A-87545651 |
| 6 | Chopper Drive (bsn C579) | 1 | 87031779 | A-87031779 |
| 6 | Chopper Drive (asn D580) | 1 | 87580100 | A-87580100 |
| 7 | Beater Drive | 1 | 87546479 | A-87546479 |
| 8 | Beater Drive | 1 | 87315599 | A-87315599 |
| 9 | Shaker Shoe Drive - Self-levelling | 2 | 87325684 | A-87325684 |
| 10 | Chopper Drive (bsn C723) | 1 | 87526022 | A-87526022 |
| 10 | Chopper Drive (asn D724) | 1 | 84168012 | A-84168012 |
| 11 | Air Conditioner Unit : Mounting Group | 1 | 84818008 | A-84818008 |
| 12 | Drive, Rotary Screen And Fan | 2 | 9818704 | A-9818704 |
| 13 | Drive, Rotary Screen And Fan | 2 | 87653464 | A-87653464 |
| 14 | Engine Drive Belt | 1 | 87663279 | A-87663279 |
| 14 | Engine Drive Belt | 1 | 87662910 | A-87662910 |
| 15 | Rotor Variator (reinforced Belt) (asn D660) | 1 | 87540195 | A-87540195 |
| 18 | Feeder Drive | 1 | 87741240 | A-87741240 |
| 19 | Tailings Elevators, Bottom Auger & R/H(BSN C675) | 2 | 84058339 | A-84058339 |
| 19 | Tailings Elevators, Bottom Auger & R/H(BSN F676719) | 2 | 84455757 | A-84455757 |
| 19 | Tailings Elevators, Bottom Auger & R/H (ASN D720) | 2 | 84196804 | A-84196804 |
| 20 | Grain Elevator Drive | 1 | 84137965 | A-84137965 |
| 21 | Fan Vari-drive | 1 | 84817627 | A-84817627 |
| 24 | Grass Seed Equipment - Accessories | 1 | 84023277 | A-84023277 |
| 25 | Hydraulic Fan Drive | 1 | 87636309 | A-87636309 |

NEW HOLLAND CS 520



| Belt No. | | No. of Belts | OEM  Part No. | PIX  Part No. |
|----------|--------------------------------------|--------------|--|--|
| 2 | Straw Elevator Drive, 2HB | 1 | 84982278 | A-84982278 |
| 2 | Straw Elevator Drive, 3HB | 1 | 84991234 | A-84991234 |
| 3 | Header Drive Engaging Idler 2HB Only | 1 | 84446792 | A-84446792 |
| 4 | Drum Variator | 1 | 84035748 | A-84035748 |
| 5 | Grain Tank Discharge | 1 | 84462590 | A-84462590 |
| 6 | Main Drive | 1 | 84993120 | A-84993120 |
| 7 | Hydrostatic Pump Drive | 1 | 80427456 | A-80427456 |
| 8 | Hydrostatic Pump Drive | 1 | 84607712 | A-84607712 |
| 9 | Straw Walker Drive | 1 | 84073276 | A-84073276 |
| 10 | Grain Elevator Bottom Auger | 1 | 80422731 | A-80422731 |
| 12 | Chaff Spreader | 1 | 84790244 | A-84790244 |
| 13 | Chopper Drive | 1 | 84075955 | A-84075955 |
| 14 | Chopper Drive | 1 | 84076421 | A-84076421 |
| 15 | Drive, Rotary Screen And Fan | 2 | 84061465 | A-84061465 |
| 16 | Drive, Rotary Screen And Fan | 1 | 84989965 | A-84989965 |
| 17 | Intermediate Motor Drive | 1 | 84817626 | A-84817626 |
| 18 | Compressor Drive | 2 | 84061465 | A-84061465 |
| 19 | Alternator Drive | 1 | 84817638 | A-84817638 |
| 20 | Drum Drive | 1 | 84072772 | A-84072772 |
| 20 | Drum Drive, Rotation Speed Slow | 1 | 84072815 | A-84072815 |



| Belt No. |  | No. of Belts | OEM  Part No. | PIX  Part No. |
|----------|---|--------------|--|--|
| 21 | Straw Shaker Drive | 1 | 84817635 | A-84817635 |
| 22 | Fan Vari-drive | 1 | 84073979 | A-84073979 |
| 23 | Rotary Separator Drive Andshaft | 1 | 84073933 | A-84073933 |
| 24 | Chopper Drive | 1 | 84075955 | A-84075955 |
| 25 | Chopper Drive | 1 | 84076421 | A-84076421 |
| 26 | Chaff Spreader | 1 | 84790244 | A-84790244 |
| 27 | Chaff Spreader | 1 | 84790355 | A-84790355 |

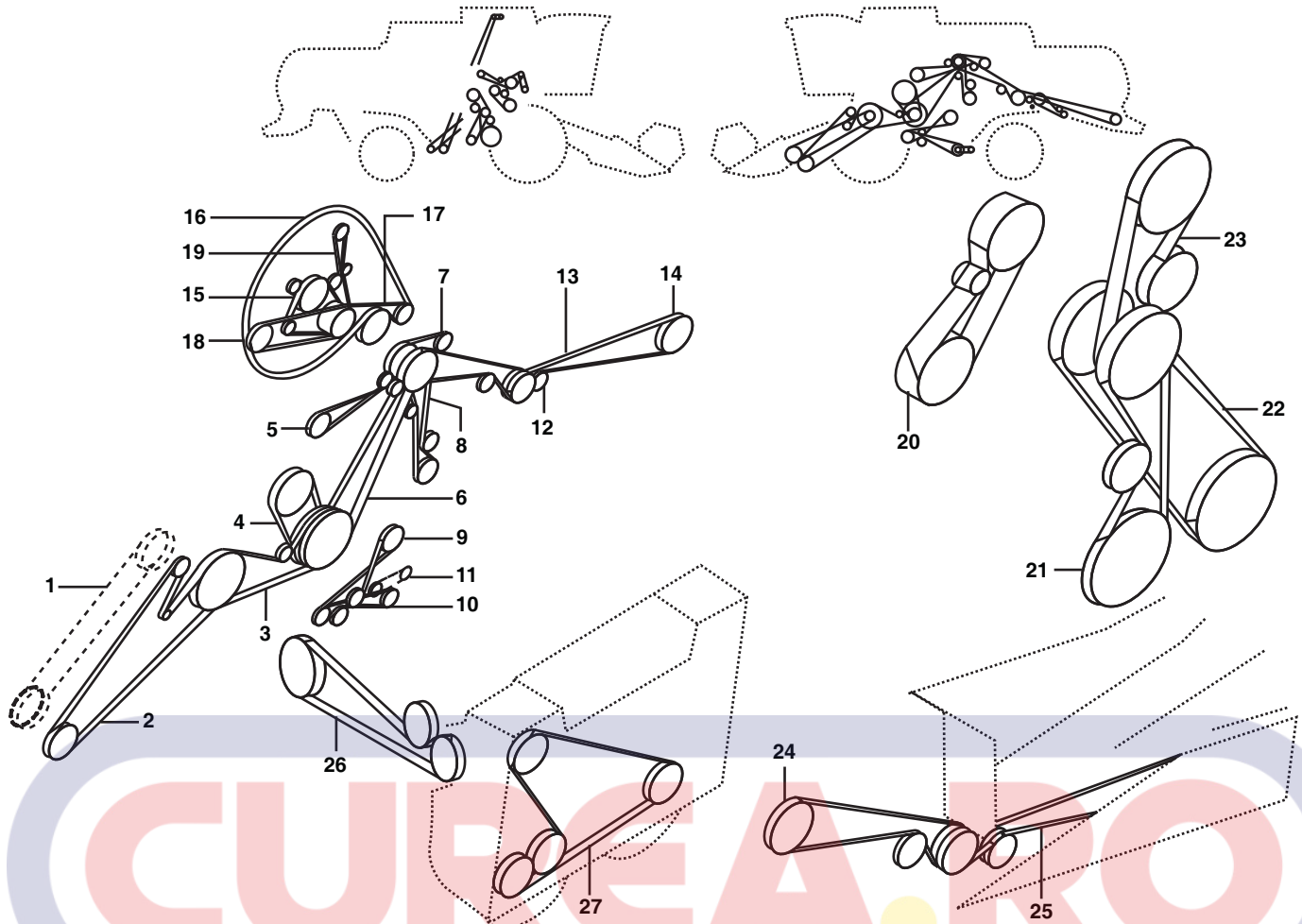

NEW HOLLAND CS 540





| Belt No. | | No. of Belts | OEM  Part No. | PIX  Part No. |
|----------|-------------------------------------|--------------|--|--|
| 2 | Straw Elevator Drive, 2hb | 1 | 84981586 | A-84981586 |
| 2 | Straw Elevator Drive, 3hb | 1 | 84991234 | A-84991234 |
| 3 | Header Drive Engagingidler 2hb Only | 1 | 89817374 | A-89817374 |
| 4 | Drum Variator | 1 | 84035748 | A-84035748 |
| 5 | Grain Tank Discharge | 1 | 84462590 | A-84462590 |
| 6 | Main Drive | 1 | 84993120 | A-84993120 |
| 7 | Hydrostatic Pump Drive | 1 | 80427456 | A-80427456 |
| 8 | Hydrostatic Pump Drive | 1 | 84607712 | A-84607712 |
| 9 | Straw Walker Drive | 1 | 84073276 | A-84073276 |
| 10 | Grain Elevator Bottom Auger | 1 | 80422731 | A-80422731 |
| 12 | Chaff Spreader | 1 | 84790244 | A-84790244 |
| 13 | Chopper Drive | 1 | 84075955 | A-84075955 |
| 14 | Chopper Drive | 1 | 84076421 | A-84076421 |
| 15 | Drive, Rotary Screen And Fan | 2 | 84061465 | A-84061465 |
| 16 | Drive, Rotary Screen And Fan | 1 | 84989965 | A-84989965 |
| 17 | Intermediate Motor Drive | 1 | 84817626 | A-84817626 |
| 18 | Compressor Drive | 2 | 84061465 | A-84061465 |
| 19 | Alternator Drive | 1 | 84817638 | A-84817638 |
| 20 | Drum Drive | 1 | 84072772 | A-84072772 |
| 20 | Drum Drive, Rotation Speed Slow | 1 | 84072815 | A-84072815 |



| Belt No. |  | No. of Belts | OEM  Part No. | PIX  Part No. |
|----------|---|--------------|--|--|
| 21 | Straw Shaker Drive | 1 | 84817635 | A-84817635 |
| 22 | Fan Vari-drive | 1 | 84073979 | A-84073979 |
| 23 | Rotary Separator Drive And Shaft | 1 | 84073933 | A-84073933 |
| 24 | Chopper Drive | 1 | 84075955 | A-84075955 |
| 25 | Chopper Drive | 1 | 84076421 | A-84076421 |
| 26 | Chaff Spreader | 1 | 84790244 | A-84790244 |
| 27 | Chaff Spreader | 1 | 84790355 | A-84790355 |

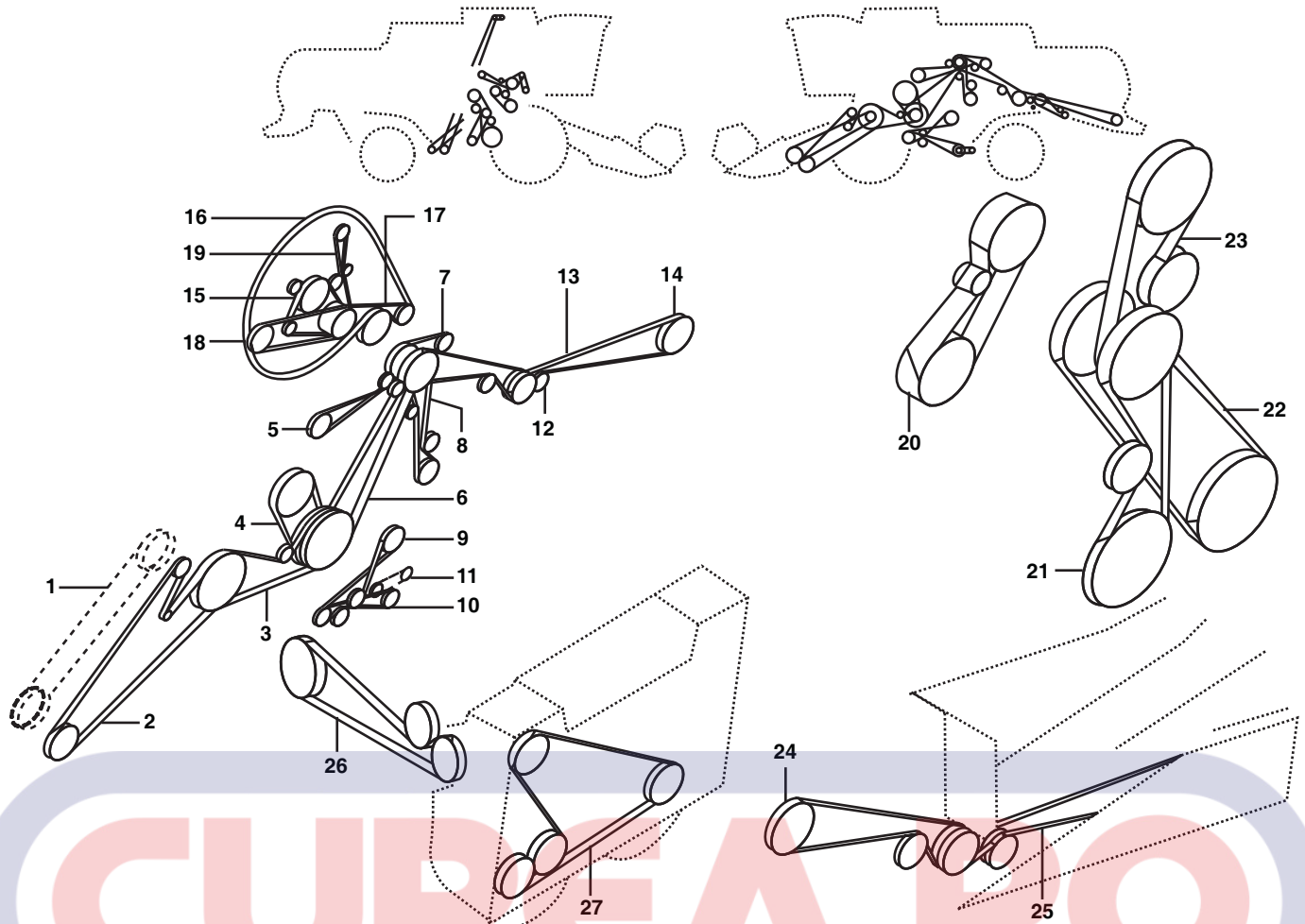

NEW HOLLAND CS 640





| Belt No. | | No. of Belts | OEM  Part No. | PIX  Part No. |
|----------|--------------------------------------|--------------|--|--|
| 2 | Straw Elevator Drive, 2HB | 1 | 84981586 | A-84981586 |
| 2 | Straw Elevator Drive, 3HB | 1 | 84991234 | A-84991234 |
| 3 | Header Drive Engaging Idler 2HB Only | 1 | 89817374 | A-89817374 |
| 4 | Drum Variator | 1 | 84035748 | A-84035748 |
| 5 | Grain Tank Discharge | 1 | 84462590 | A-84462590 |
| 6 | Main Drive | 1 | 84993120 | A-84993120 |
| 7 | Hydrostatic Pump Drive | 1 | 80427456 | A-80427456 |
| 8 | Hydrostatic Pump Drive | 1 | 84607712 | A-84607712 |
| 9 | Straw Walker Drive | 1 | 84073276 | A-84073276 |
| 10 | Grain Elevator Bottom Auger | 1 | 80422731 | A-80422731 |
| 12 | Chaff Spreader | 1 | 84790244 | A-84790244 |
| 13 | Chopper Drive | 1 | 84075955 | A-84075955 |
| 14 | Chopper Drive | 1 | 84076421 | A-84076421 |
| 15 | Drive, Rotary Screen And Fan | 2 | 84061465 | A-84061465 |
| 16 | Drive, Rotary Screen And Fan | 1 | 84989965 | A-84989965 |
| 17 | Intermediate Motor Drive | 1 | 84817626 | A-84817626 |
| 18 | Compressor Drive | 2 | 84061465 | A-84061465 |
| 19 | Alternator Drive | 1 | 84817638 | A-84817638 |
| 20 | Drum Drive | 1 | 84072772 | A-84072772 |
| 20 | Drum Drive, Rotation Speed Slow | 1 | 84072815 | A-84072815 |
| 21 | Straw Shaker Drive | 1 | 84817635 | A-84817635 |



| Belt No. |  | No. of Belts | OEM  Part No. | PIX  Part No. |
|-----------------|---|---------------------|---|---|
| 22 | Fan Vari-drive | 1 | 84073979 | A-84073979 |
| 23 | Rotary Separator Drive Andshaft | 1 | 84073933 | A-84073933 |
| 24 | Chopper Drive | 1 | 84075955 | A-84075955 |
| 25 | Chopper Drive | 1 | 84076421 | A-84076421 |
| 26 | Chaff Spreader | 1 | 84790244 | A-84790244 |
| 27 | Chaff Spreader | 1 | 84790356 | A-84790356 |

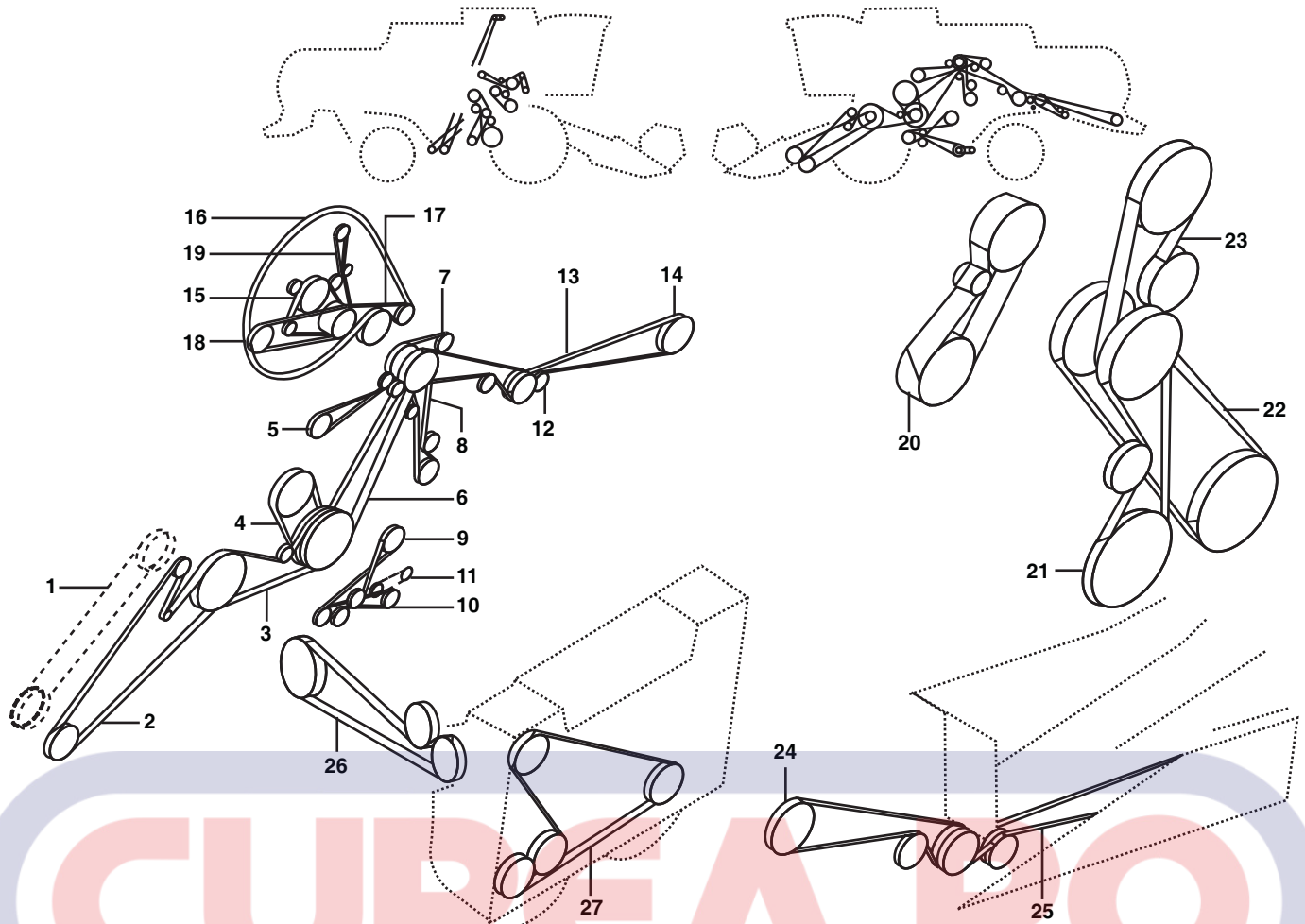

NEW HOLLAND CS 660



| Belt No. | | No. of Belts | OEM  Part No. | PIX  Part No. |
|----------|--------------------------------------|--------------|--|--|
| 2 | Straw Elevator Drive, 2HB | 1 | 84981586 | A-84981586 |
| 2 | Straw Elevator Drive, 3HB | 1 | 84991234 | A-84991234 |
| 3 | Header Drive Engaging idler 2HB Only | 1 | 89817374 | A-89817374 |
| 4 | Drum Variator | 1 | 84035748 | A-84035748 |
| 5 | Grain Tank Discharge | 1 | 84462590 | A-84462590 |
| 6 | Main Drive | 1 | 84993120 | A-84993120 |
| 7 | Hydrostatic Pump Drive | 1 | 80427456 | A-80427456 |
| 8 | Hydrostatic Pump Drive | 1 | 84607713 | A-84607713 |
| 9 | Straw Walker Drive | 1 | 84073276 | A-84073276 |
| 10 | Grain Elevator Bottom Auger | 1 | 80422731 | A-80422731 |
| 12 | Chaff Spreader | 1 | 84790244 | A-84790244 |
| 13 | Chopper Drive | 1 | 84075955 | A-84075955 |
| 14 | Chopper Drive | 1 | 84076421 | A-84076421 |
| 15 | Drive, Rotary Screen & Fan | 2 | 84061465 | A-84061465 |
| 16 | Drive, Rotary Screen & Fan | 1 | 84989965 | A-84989965 |
| 17 | Intermediate Motor Drive | 1 | 84817626 | A-84817626 |
| 18 | Compressor Drive | 2 | 84061465 | A-84061465 |
| 19 | Alternator Drive | 1 | 84817638 | A-84817638 |
| 20 | Drum Drive | 1 | 84072772 | A-84072772 |
| 20 | Drum Drive, Rotation Speed Slow | 1 | 84072815 | A-84072815 |



| Belt No. |  | No. of Belts | OEM  Part No. | PIX  Part No. |
|-----------------|---|---------------------|---|---|
| 21 | Straw Shaker Drive | 1 | 84817635 | A-84817635 |
| 22 | Fan Vari-drive | 1 | 84073979 | A-84073979 |
| 23 | Rotary Separator Drive & Shaft | 1 | 84073933 | A-84073933 |
| 24 | Chopper Drive | 1 | 84075955 | A-84075955 |
| 25 | Chopper Drive | 1 | 84076421 | A-84076421 |
| 26 | Chaff Spreader | 1 | 84790244 | A-84790244 |
| 27 | Chaff Spreader | 1 | 84790356 | A-84790356 |

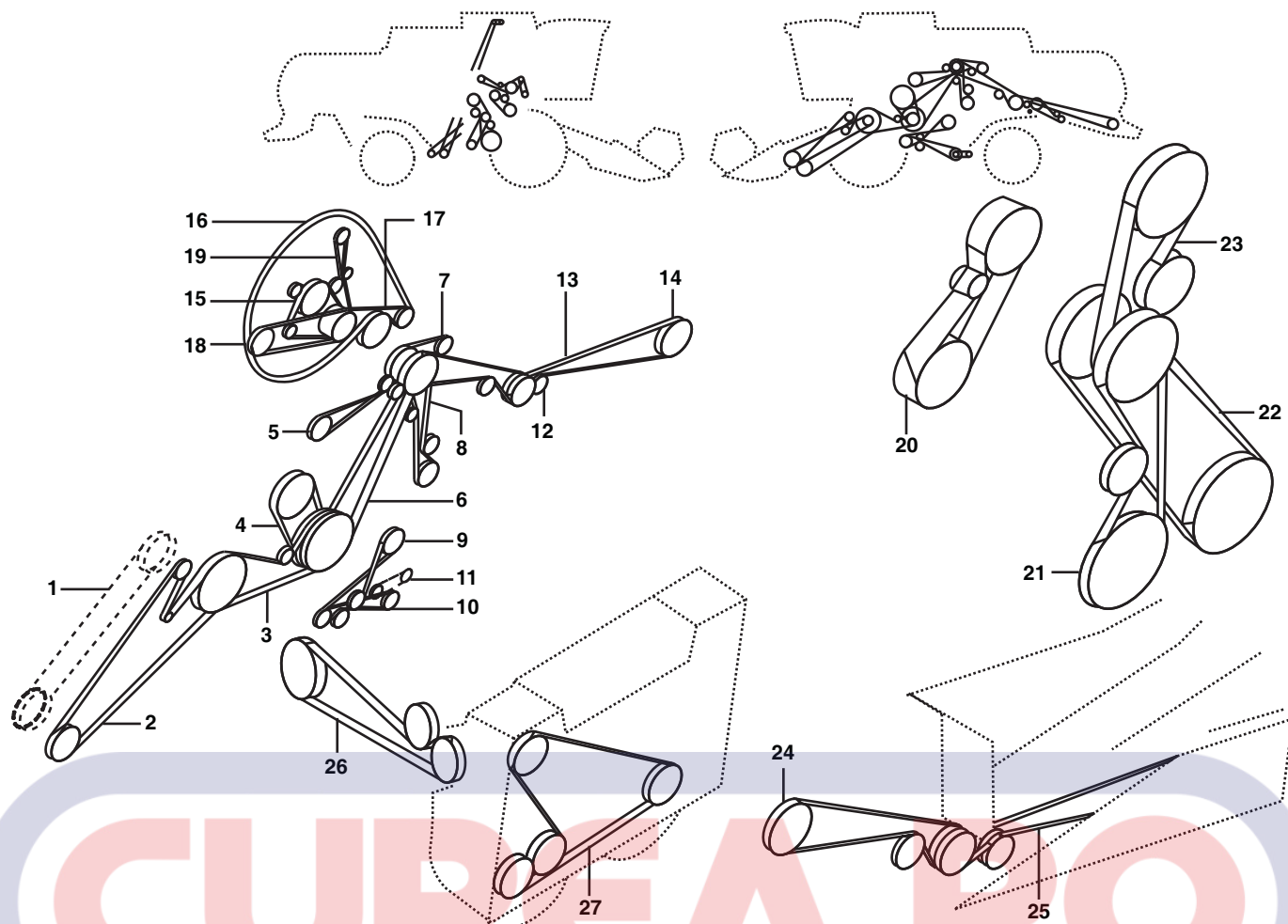

NEW HOLLAND CS 6050





| Belt No. | | No. of Belts | OEM  Part No. | PIX  Part No. |
|----------|--------------------------------------|--------------|--|--|
| 2 | Straw Elevator Drive, 2HB | 1 | 84981586 | A-84981586 |
| 2 | Straw Elevator Drive, 3HB | 1 | 84991234 | A-84991234 |
| 3 | Header Drive Engaging Idler 2HB Only | 1 | 84446792 | A-84446792 |
| 3 | Header Drive Engaging Idler 3HB Only | 1 | 89817374 | A-89817374 |
| 4 | Drum Variator | 1 | 84035748 | A-84035748 |
| 5 | Grain Tank Discharge | 1 | 84462590 | A-84462590 |
| 6 | Main Drive | 1 | 84993120 | A-84993120 |
| 7 | Hydrostatic Pump Drive | 1 | 80427456 | A-80427456 |
| 8 | Hydrostatic Pump Drive | 1 | 84607712 | A-84607712 |
| 9 | Straw Walker Drive | 1 | 87521887 | A-87521887 |
| 10 | Grain Elevator Bottom Auger | 1 | 80422731 | A-80422731 |
| 12 | Chaff Spreader | 1 | 84790244 | A-84790244 |
| 13 | Chopper Drive | 1 | 84075955 | A-84075955 |
| 14 | Chopper Drive | 1 | 84076421 | A-84076421 |
| 15 | Drive, Rotary Screen And Fan | 2 | 84061465 | A-84061465 |
| 16 | Drive, Rotary Screen And Fan | 1 | 84989965 | A-84989965 |
| 17 | Alternator Drive | 1 | 747177 | A-747177 |
| 20 | Drum Drive | 1 | 84072772 | A-84072772 |
| 20 | Drum Drive, Rotation Speed Slow | 1 | 84072815 | A-84072815 |
| 21 | Straw Shaker Drive | 1 | 84817635 | A-84817635 |
| 22 | Fan Vari-drive | 1 | 84073979 | A-84073979 |



| Belt No. |  | No. of Belts | OEM  Part No. | PIX  Part No. |
|----------|---|--------------|--|--|
| 23 | Rotary Separator Drive & shaft | 1 | 84073933 | A-84073933 |
| 24 | Chopper Drive | 1 | 84075955 | A-84075955 |
| 25 | Chopper Drive | 1 | 84076421 | A-84076421 |
| 26 | Chaff Spreader | 1 | 84790244 | A-84790244 |
| 27 | Chaff Spreader | 1 | 84790355 | A-84790355 |

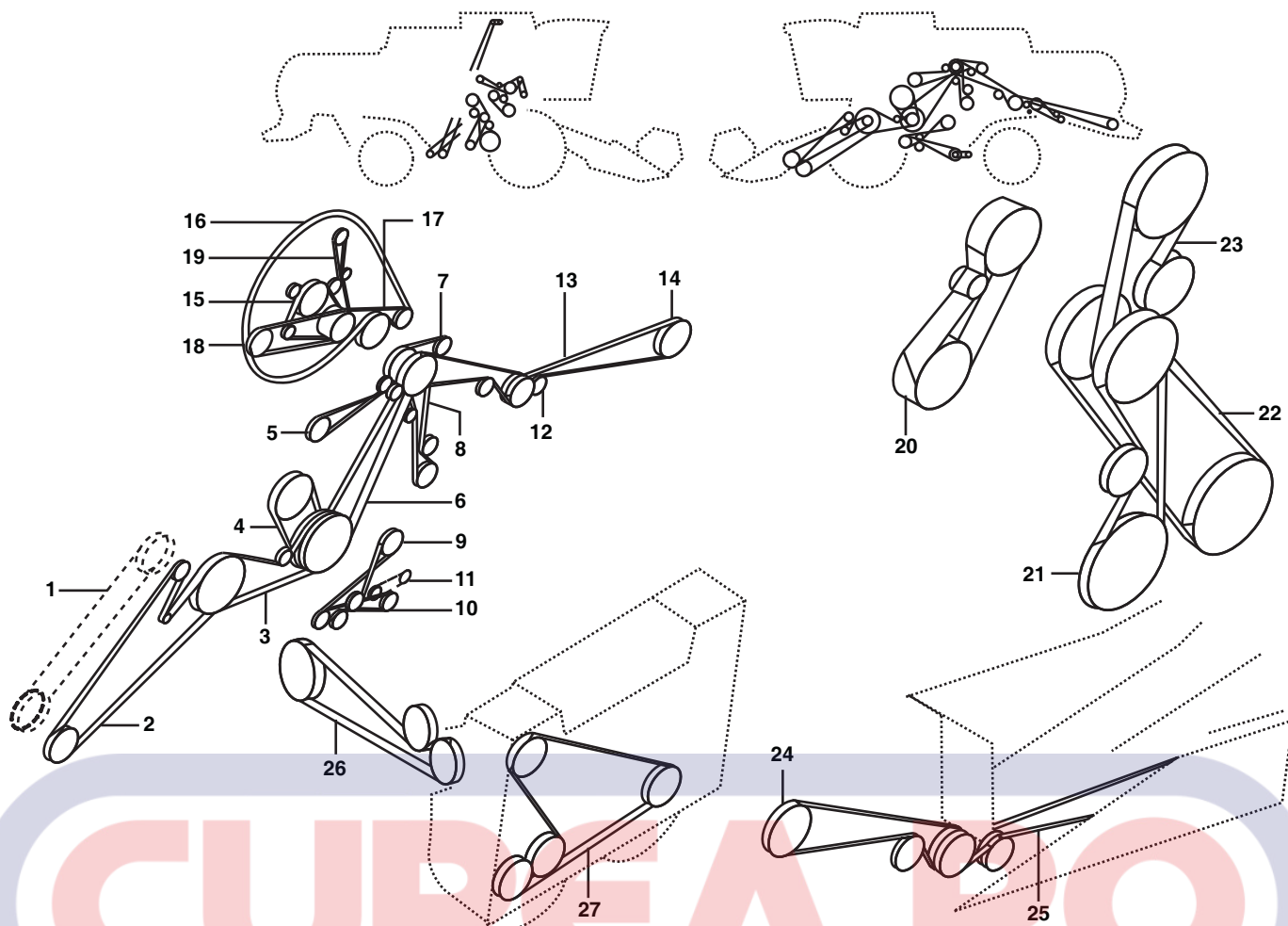

NEW HOLLAND CS 6060





| Belt No. | | No. of Belts | OEM  Part No. | PIX  Part No. |
|----------|--------------------------------------|--------------|--|--|
| 2 | Straw Elevator Drive, 2HB | 1 | 84981586 | A-84981586 |
| 2 | Straw Elevator Drive, 3HB | 1 | 84991234 | A-84991234 |
| 3 | Header Drive Engaging idler 2HB Only | 1 | 84446792 | A-84446792 |
| 3 | Header Drive Engaging idler 3HB Only | 1 | 89817374 | A-89817374 |
| 4 | Drum Variator | 1 | 84035748 | A-84035748 |
| 5 | Grain Tank Discharge | 1 | 84462590 | A-84462590 |
| 6 | Main Drive | 1 | 84993120 | A-84993120 |
| 7 | Hydrostatic Pump Drive | 1 | 80427456 | A-80427456 |
| 9 | Straw Walker Drive | 1 | 87521887 | A-87521887 |
| 10 | Grain Elevator Bottom Auger | 1 | 80422731 | A-80422731 |
| 12 | Chaff Spreader | 1 | 84790244 | A-84790244 |
| 13 | Chopper Drive | 1 | 84075955 | A-84075955 |
| 14 | Chopper Drive | 1 | 84076421 | A-84076421 |
| 15 | Drive, Rotary Screen & Fan | 2 | 84061465 | A-84061465 |
| 16 | Drive, Rotary Screen & Fan | 1 | 84989965 | A-84989965 |
| 17 | Alternator Drive | 1 | 747177 | A-747177 |
| 19 | Hydrostatic Pump Drive | 1 | 87721960 | A-87721960 |
| 20 | Drum Drive | 1 | 84072772 | A-84072772 |
| 20 | Drum Drive, Rotation Speed Slow | 1 | 84072815 | A-84072815 |
| 21 | Straw Shaker Drive | 1 | 84817635 | A-84817635 |
| 22 | Fan Vari-drive | 1 | 84073979 | A-84073979 |



| Belt No. |  | No. of Belts | OEM  Part No. | PIX  Part No. |
|----------|---|--------------|--|--|
| 23 | Rotary Separator Drive & Shaft | 1 | 84073933 | A-84073933 |
| 24 | Chopper Drive | 1 | 84075955 | A-84075955 |
| 25 | Chopper Drive | 1 | 84076421 | A-84076421 |
| 26 | Chaff Spreader | 1 | 84790244 | A-84790244 |
| 27 | Chaff Spreader | 1 | 84790355 | A-84790355 |

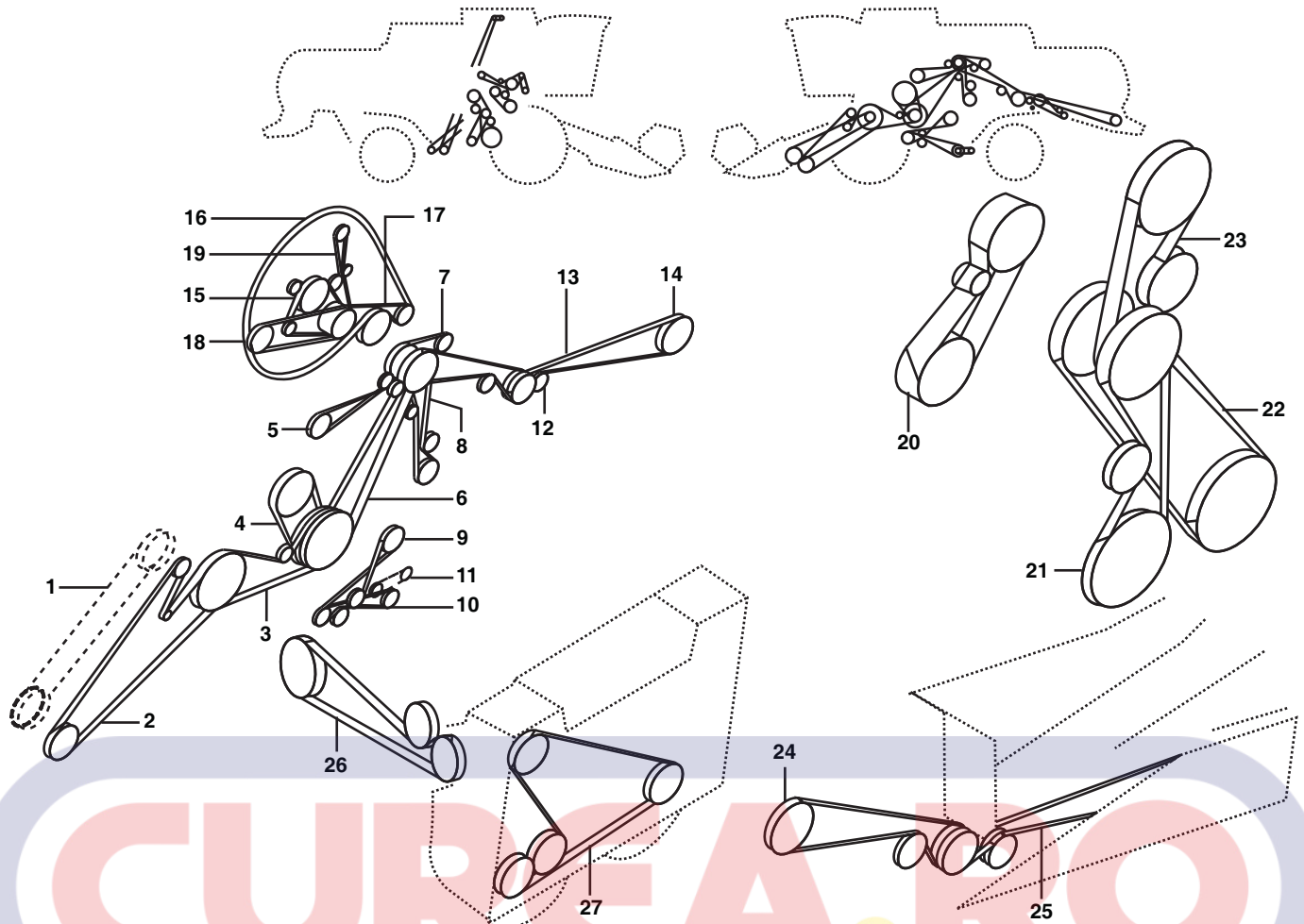

NEW HOLLAND CS 6060 - HILLSIDE







| Belt No. | | No. of Belts | OEM  Part No. | PIX  Part No. |
|----------|--------------------------------------|--------------|--|--|
| 2 | Straw Elevator Drive, 2HB | 1 | 84981586 | A-84981586 |
| 2 | Straw Elevator Drive, 3HB | 1 | 84991234 | A-84991234 |
| 3 | Header Drive Engaging Idler 2HB Only | 1 | 84446792 | A-84446792 |
| 3 | Header Drive Engaging Idler 3HB Only | 1 | 89817374 | A-89817374 |
| 4 | Drum Variator | 1 | 84035748 | A-84035748 |
| 5 | Grain Tank Discharge | 1 | 84462590 | A-84462590 |
| 6 | Main Drive | 1 | 84993120 | A-84993120 |
| 6 | Kit For Long Conveyor | 1 | 84971217 | A-84971217 |
| 7 | Hydrostatic Pump Drive | 1 | 80427456 | A-80427456 |
| 9 | Straw Walker Drive | 1 | 87521887 | A-87521887 |
| 10 | Grain Elevator Bottom Auger | 1 | 80422731 | A-80422731 |
| 12 | Chaff Spreader | 1 | 84790244 | A-84790244 |
| 13 | Chopper Drive | 1 | 84075955 | A-84075955 |
| 14 | Chopper Drive | 1 | 84076421 | A-84076421 |
| 15 | Drive, Rotary Screen & Fan | 2 | 84061465 | A-84061465 |
| 16 | Drive, Rotary Screen & Fan | 1 | 84989965 | A-84989965 |
| 17 | Alternator Drive | 1 | 747177 | A-747177 |
| 19 | Hydrostatic Pump Drive | 1 | 84607713 | A-84607713 |
| 20 | Drum Drive | 1 | 84072772 | A-84072772 |
| 20 | Drum Drive, Rotation Speed Slow | 1 | 84072815 | A-84072815 |
| 21 | Straw Shaker Drive | 1 | 84817635 | A-84817635 |

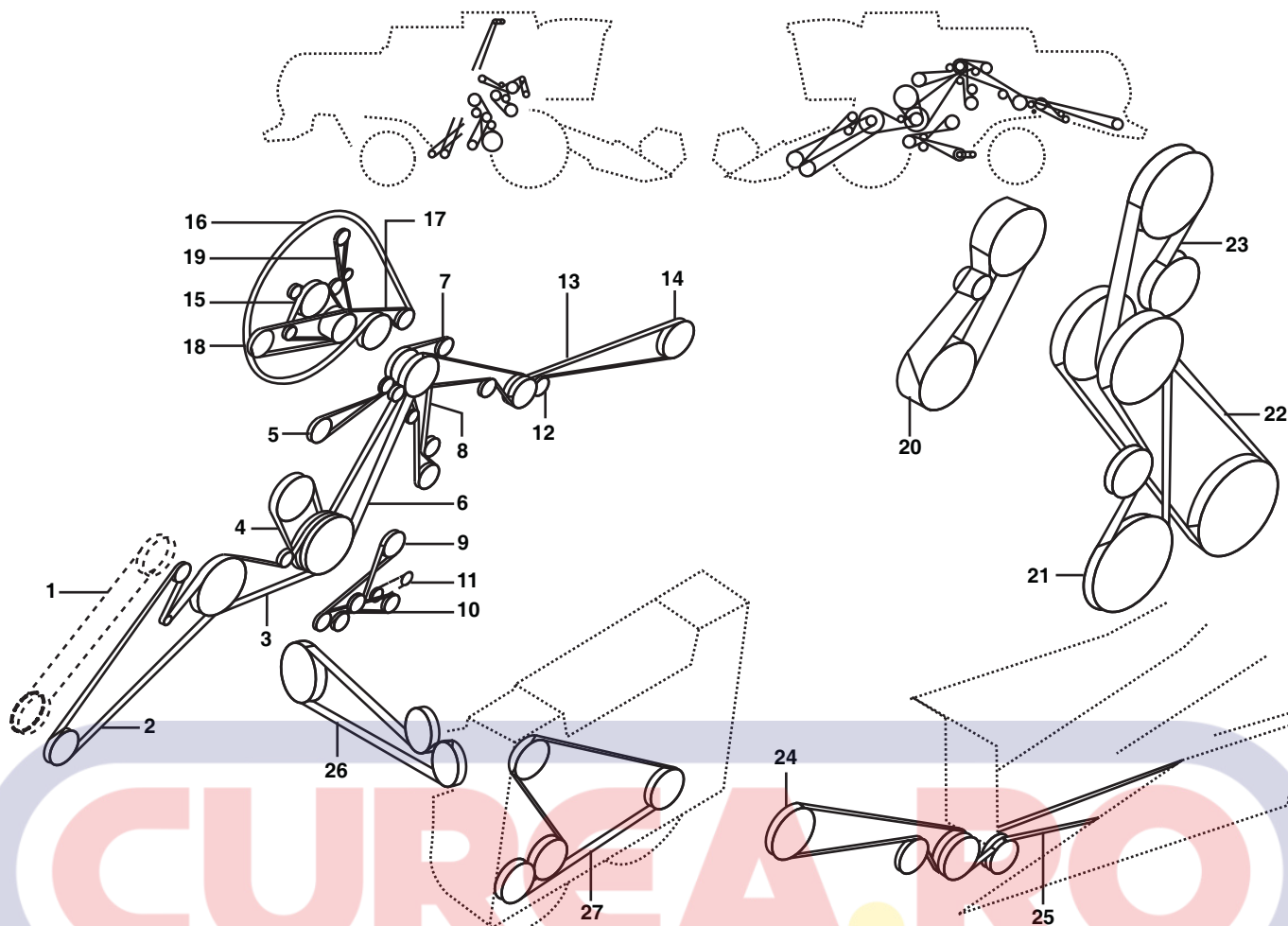

| Belt No. |  | No. of Belts | OEM  Part No. | PIX  Part No. |
|-----------------|---|---------------------|---|---|
| 22 | Fan Vari-drive | 1 | 84073979 | A-84073979 |
| 23 | Rotary Separator Drive & shaft | 1 | 84073933 | A-84073933 |
| 24 | Chopper Drive | 1 | 84075955 | A-84075955 |
| 25 | Chopper Drive | 1 | 84076421 | A-84076421 |
| 26 | Chaff Spreader | 1 | 84790244 | A-84790244 |
| 27 | Chaff Spreader | 1 | 84790355 | A-84790355 |



NEW HOLLAND CS 6070





| Belt No. |  | No. of Belts | OEM  Part No. | PIX  Part No. |
|----------|---|--------------|--|--|
| 2 | Straw Elevator Drive, 2HB | 1 | 84981586 | A-84981586 |
| 2 | Straw Elevator Drive, 3HB | 1 | 84991234 | A-84991234 |
| 3 | Header Drive Engaging idler 2HB Only | 1 | 84446792 | A-84446792 |
| 3 | Header Drive Engaging idler 3HB Only | 1 | 89817374 | A-89817374 |
| 4 | Drum Variator | 1 | 84035748 | A-84035748 |
| 5 | Grain Tank Discharge | 1 | 84462590 | A-84462590 |
| 6 | Main Drive | 1 | 84993120 | A-84993120 |
| 7 | Hydrostatic Pump Drive | 1 | 80427456 | A-80427456 |
| 8 | Hydrostatic Pump Drive | 1 | 84607712 | A-84607712 |
| 9 | Straw Walker Drive | 1 | 87521887 | A-87521887 |
| 10 | Grain Elevator Bottom Auger | 1 | 80422731 | A-80422731 |
| 12 | Chaff Spreader | 1 | 84790244 | A-84790244 |
| 13 | Chopper Drive | 1 | 84075955 | A-84075955 |
| 14 | Chopper Drive | 1 | 84076421 | A-84076421 |
| 15 | Drive, Rotary Screen & Fan | 2 | 84061465 | A-84061465 |
| 16 | Drive, Rotary Screen & Fan | 1 | 84989965 | A-84989965 |
| 17 | Alternator Drive | 1 | 747177 | A-747177 |
| 20 | Drum Drive | 1 | 84072772 | A-84072772 |
| 20 | Drum Drive, Rotation Speed Slow | 1 | 84072815 | A-84072815 |



| Belt No. |  | No. of Belts | OEM  Part No. | PIX  Part No. |
|-----------------|---|---------------------|---|---|
| 21 | Straw Shaker Drive | 1 | 84817635 | A-84817635 |
| 22 | Fan Vari-drive | 1 | 84073979 | A-84073979 |
| 23 | Rotary Separator Drive & Shaft | 1 | 84073933 | A-84073933 |
| 24 | Chopper Drive | 1 | 84075955 | A-84075955 |
| 25 | Chopper Drive | 1 | 84076421 | A-84076421 |
| 26 | Chaff Spreader | 1 | 84790244 | A-84790244 |
| 27 | Chaff Spreader | 1 | 84790356 | A-84790356 |

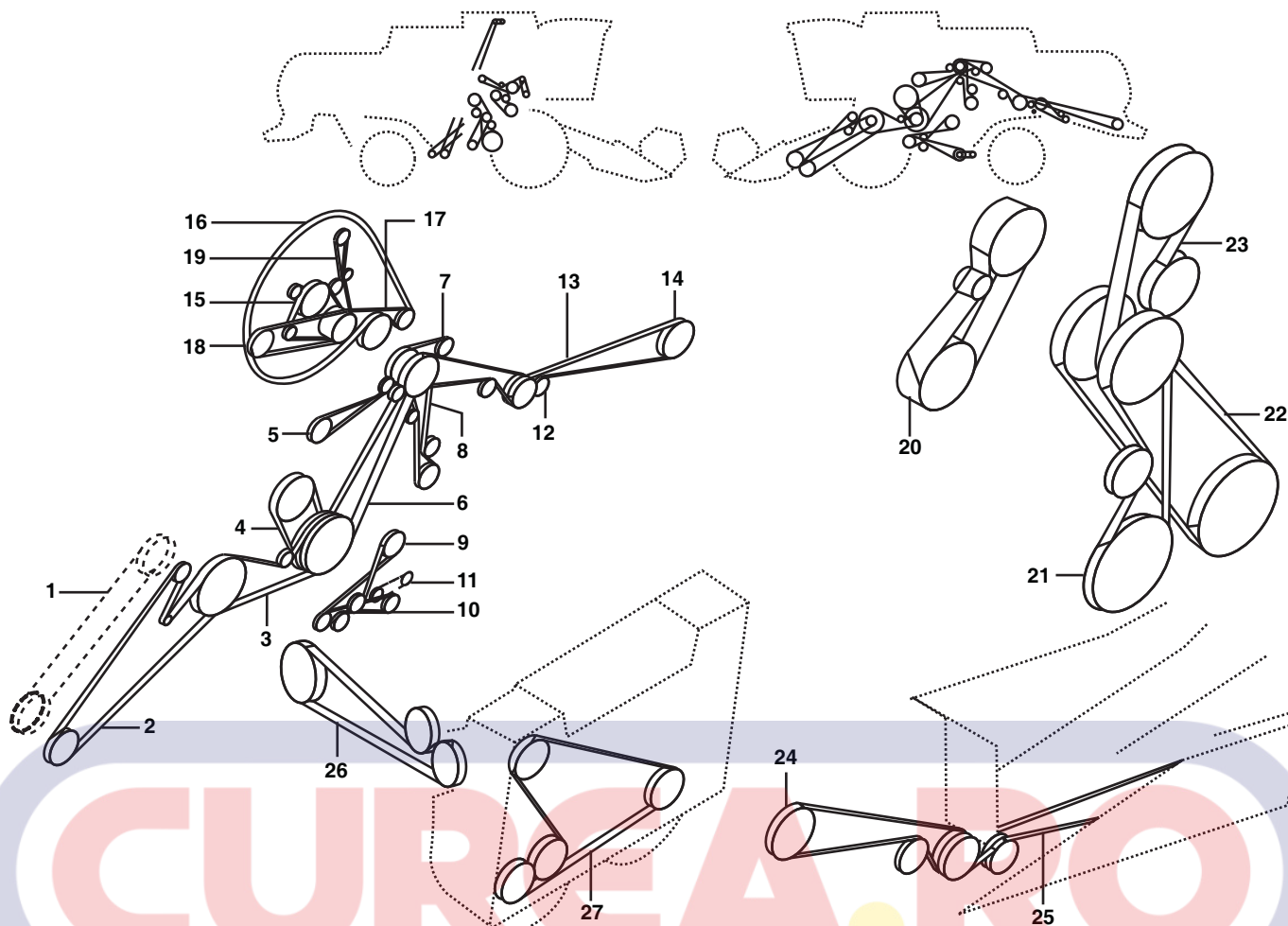

NEW HOLLAND CS 6080



| Belt No. | | No. of Belts | OEM  Part No. | PIX  Part No. |
|----------|--------------------------------------|--------------|--|--|
| 2 | Straw Elevator Drive, 2HB | 1 | 84981586 | A-84981586 |
| 2 | Straw Elevator Drive, 3HB | 1 | 84991234 | A-84991234 |
| 3 | Header Drive Engaging Idler 2HB Only | 1 | 84446792 | A-84446792 |
| 3 | Header Drive Engaging Idler 3HB Only | 1 | 89817374 | A-89817374 |
| 4 | Drum Variator | 1 | 84035748 | A-84035748 |
| 5 | Grain Tank Discharge | 1 | 84462590 | A-84462590 |
| 6 | Main Drive | 1 | 84993120 | A-84993120 |
| 7 | Hydrostatic Pump Drive | 1 | 80427456 | A-80427456 |
| 8 | Hydrostatic Pump Drive | 1 | 84607712 | A-84607712 |
| 9 | Straw Walker Drive | 1 | 87521887 | A-87521887 |
| 10 | Grain Elevator Bottom Auger | 1 | 80422731 | A-80422731 |
| 12 | Chaff Spreader | 1 | 84790244 | A-84790244 |
| 13 | Chopper Drive | 1 | 84075955 | A-84075955 |
| 14 | Chopper Drive | 1 | 84076421 | A-84076421 |
| 15 | Drive, Rotary Screen & Fan | 2 | 84061463 | A-84061463 |
| 16 | Drive, Rotary Screen & Fan | 1 | 87374615 | A-87374615 |
| 17 | Alternator Drive | 1 | 84817626 | A-84817626 |
| 20 | Drum Drive | 1 | 84072772 | A-84072772 |
| 20 | Drum Drive, Rotation Speed Slow | 1 | 84072815 | A-84072815 |



| Belt No. |  | No. of Belts | OEM  Part No. | PIX  Part No. |
|----------|---|--------------|--|--|
| 21 | Straw Shaker Drive | 1 | 84817635 | A-84817635 |
| 22 | Fan Vari-drive | 1 | 84073979 | A-84073979 |
| 23 | Rotary Separator Drive & shaft | 1 | 84073933 | A-84073933 |
| 24 | Chopper Drive | 1 | 84075955 | A-84075955 |
| 25 | Chopper Drive | 1 | 84076421 | A-84076421 |
| 26 | Chaff Spreader | 1 | 84790244 | A-84790244 |
| 27 | Chaff Spreader | 1 | 84790356 | A-84790356 |

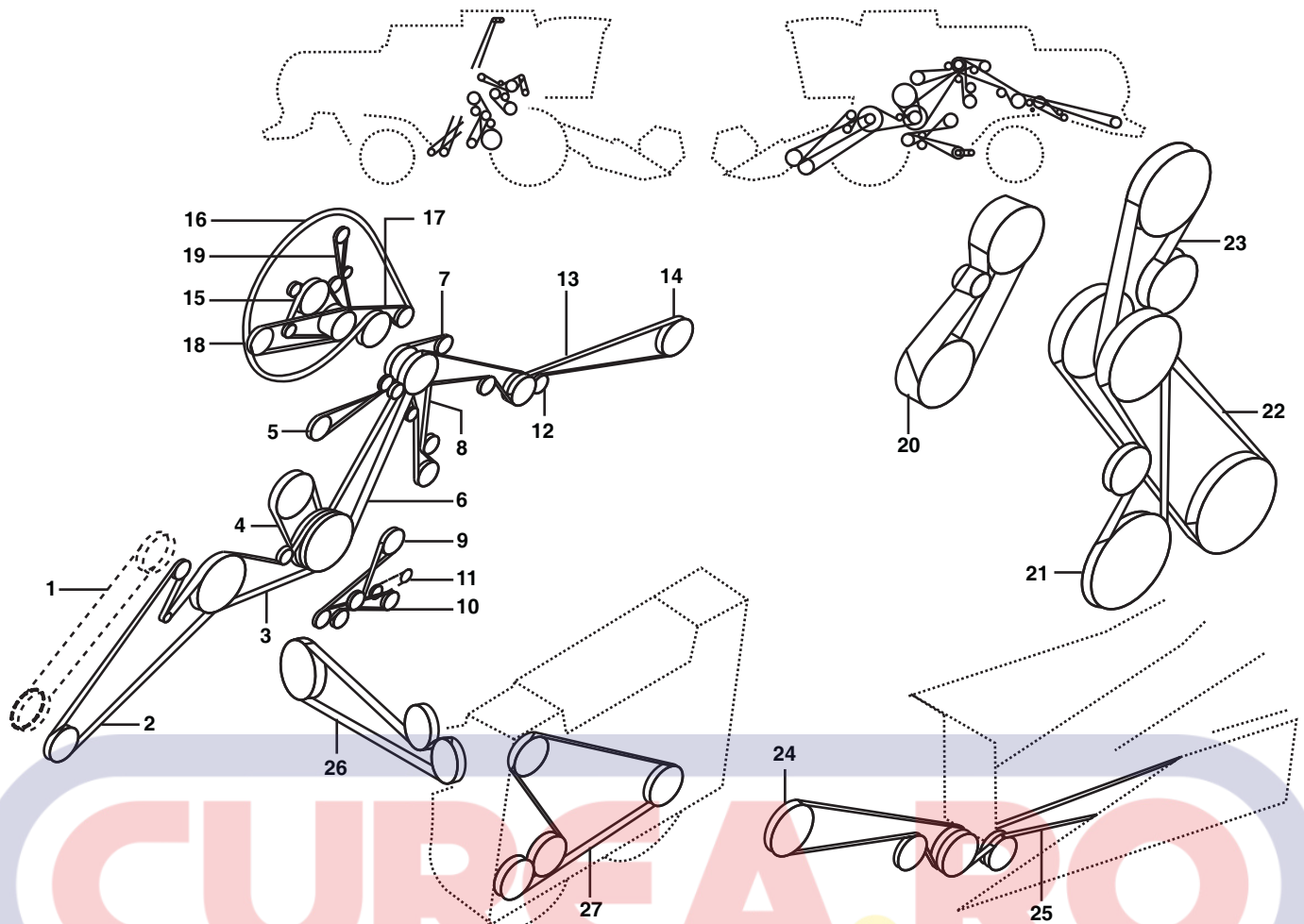

NEW HOLLAND CS 6090



| Belt No. | | No. of Belts | OEM  Part No. | PIX  Part No. |
|----------|--------------------------------------|--------------|--|--|
| 2 | Straw Elevator Drive, 2HB | 1 | 84981586 | A-84981586 |
| 2 | Straw Elevator Drive, 3HB | 1 | 84991234 | A-84991234 |
| 3 | Header Drive Engaging Idler 2HB Only | 1 | 84446792 | A-84446792 |
| 3 | Header Drive Engaging Idler 3HB Only | 1 | 89817374 | A-89817374 |
| 4 | Drum Variator | 1 | 84035748 | A-84035748 |
| 5 | Grain Tank Discharge | 1 | 84462590 | A-84462590 |
| 6 | Main Drive | 1 | 84993120 | A-84993120 |
| 7 | Hydrostatic Pump Drive | 1 | 80427456 | A-80427456 |
| 8 | Hydrostatic Pump Drive | 1 | 84607713 | A-84607713 |
| 9 | Straw Walker Drive | 1 | 87521887 | A-87521887 |
| 10 | Grain Elevator Bottom Auger | 1 | 80422731 | A-80422731 |
| 12 | Chaff Spreader | 1 | 84790244 | A-84790244 |
| 13 | Chopper Drive | 1 | 84075955 | A-84075955 |
| 14 | Chopper Drive | 1 | 84076421 | A-84076421 |
| 15 | Drive, Rotary Screen & Fan | 2 | 84061463 | A-84061463 |
| 16 | Drive, Rotary Screen & Fan | 1 | 87374615 | A-87374615 |
| 17 | Alternator Drive | 1 | 84817626 | A-84817626 |
| 20 | Drum Drive | 1 | 84072772 | A-84072772 |
| 20 | Drum Drive, Rotation Speed Slow | 1 | 84072815 | A-84072815 |



| Belt No. |  | No. of Belts | OEM  Part No. | PIX  Part No. |
|----------|---|--------------|--|--|
| 21 | Straw Shaker Drive | 1 | 84817635 | A-84817635 |
| 22 | Fan Vari-drive | 1 | 84073979 | A-84073979 |
| 23 | Rotary Separator Drive & shaft | 1 | 84073933 | A-84073933 |
| 24 | Chopper Drive | 1 | 84075955 | A-84075955 |
| 25 | Chopper Drive | 1 | 84076421 | A-84076421 |
| 26 | Chaff Spreader | 1 | 84790244 | A-84790244 |
| 27 | Chaff Spreader | 1 | 84790356 | A-84790356 |

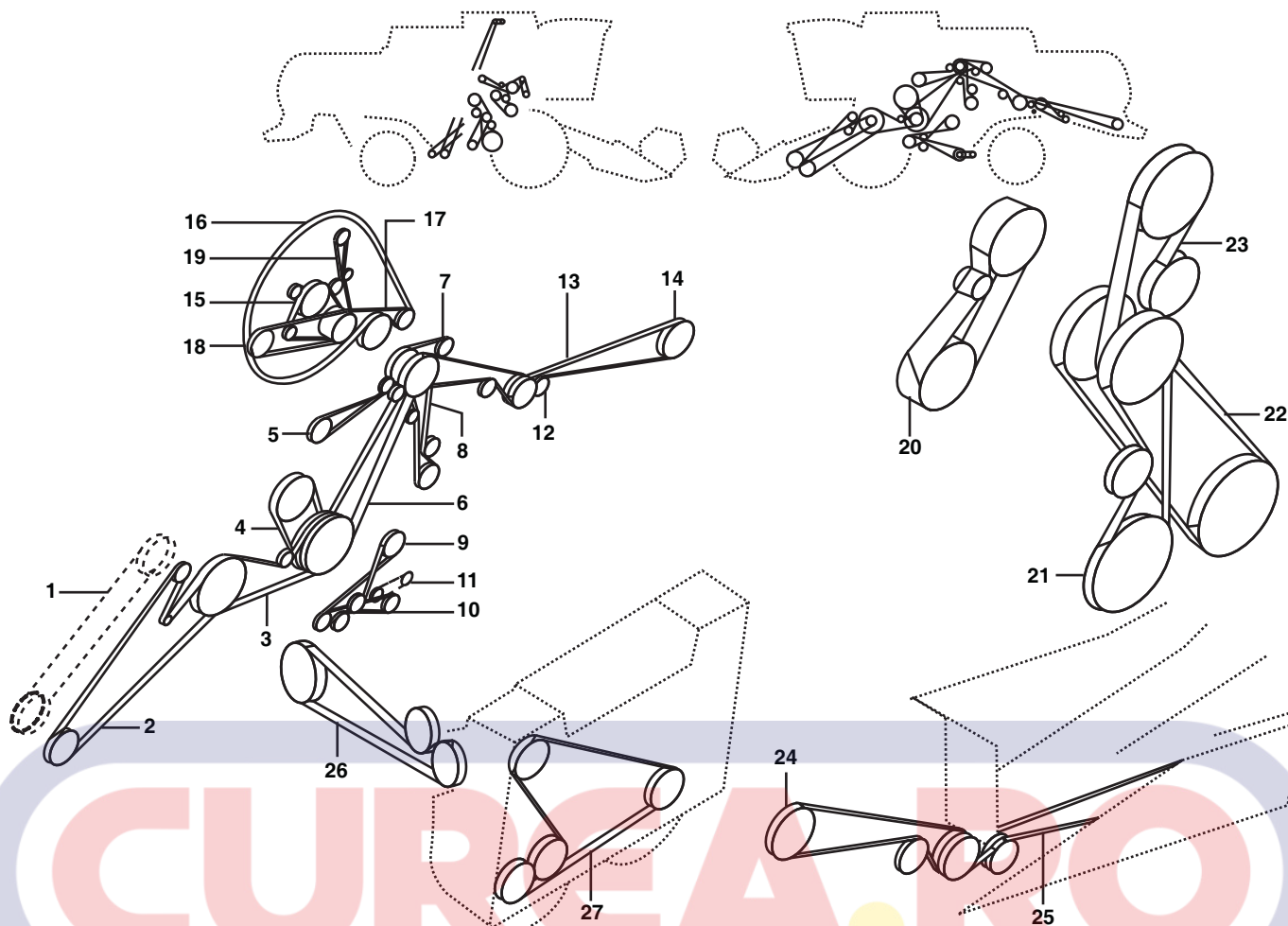

NEW HOLLAND CSX 7040





| Belt No. | | No. of Belts | OEM Part No. | PIX Part No. |
|----------|--------------------------------------|--------------|--------------|--------------|
| 2 | Straw Elevator Drive, 2HB | 1 | 84981586 | A-84981586 |
| 2 | Straw Elevator Drive, 3HB | 1 | 84991234 | A-84991234 |
| 3 | Header Drive Engaging idler 2HB Only | 1 | 84446792 | A-84446792 |
| 3 | Header Drive Engaging idler 3HB Only | 1 | 89817374 | A-89817374 |
| 4 | Drum Variator | 1 | 84035748 | A-84035748 |
| 5 | Grain Tank Discharge | 1 | 84462590 | A-84462590 |
| 5 | Rotary Screen Drive & Fan | 1 | 747177 | A-747177 |
| 6 | Main Drive | 1 | 84993120 | A-84993120 |
| 7 | Hydrostatic Pump Drive | 1 | 80427456 | A-80427456 |
| 8 | Hydrostatic Pump Drive | 1 | 84607712 | A-84607712 |
| 9 | Straw Walker Drive | 1 | 87521887 | A-87521887 |
| 9 | Grass Seed Equipment | 1 | 84452153 | A-84452153 |
| 10 | Grain Elevator Bottom Auger | 1 | 80422731 | A-80422731 |
| 12 | Chaff Spreader | 1 | 84790244 | A-84790244 |
| 13 | Chopper Drive | 1 | 84075955 | A-84075955 |
| 14 | Chopper Drive | 1 | 84076421 | A-84076421 |
| 15 | Drive, Rotary Screen & Fan | 2 | 84061463 | A-84061463 |
| 16 | Drive, Rotary Screen & Fan | 1 | 87374615 | A-87374615 |
| 17 | Alternator Drive | 1 | 84817626 | A-84817626 |



| Belt No. |  | No. of Belts | OEM  Part No. | PIX  Part No. |
|----------|---|--------------|--|--|
| 20 | Drum Drive | 1 | 84072772 | A-84072772 |
| 20 | Drum Drive, Rotation Speed Slow | 1 | 84072815 | A-84072815 |
| 21 | Straw Shaker Drive | 1 | 84817635 | A-84817635 |
| 22 | Fan Vari-drive | 1 | 84073979 | A-84073979 |
| 23 | Rotary Separator Drive And Shaft | 1 | 84073933 | A-84073933 |
| 24 | Chopper Drive | 1 | 84075955 | A-84075955 |
| 25 | Chopper Drive | 1 | 84076421 | A-84076421 |
| 26 | Chaff Spreader | 1 | 84790244 | A-84790244 |
| 26 | Rotary Screen Drive & Fan | 1 | 84989965 | A-84989965 |
| 27 | Chaff Spreader | 1 | 84790244 | A-84790244 |
| 36 | Grass Seed Equipment | 1 | 84452112 | A-84452112 |
| 36 | Rotary Screen Drive & Fan | 2 | 84061465 | A-84061465 |

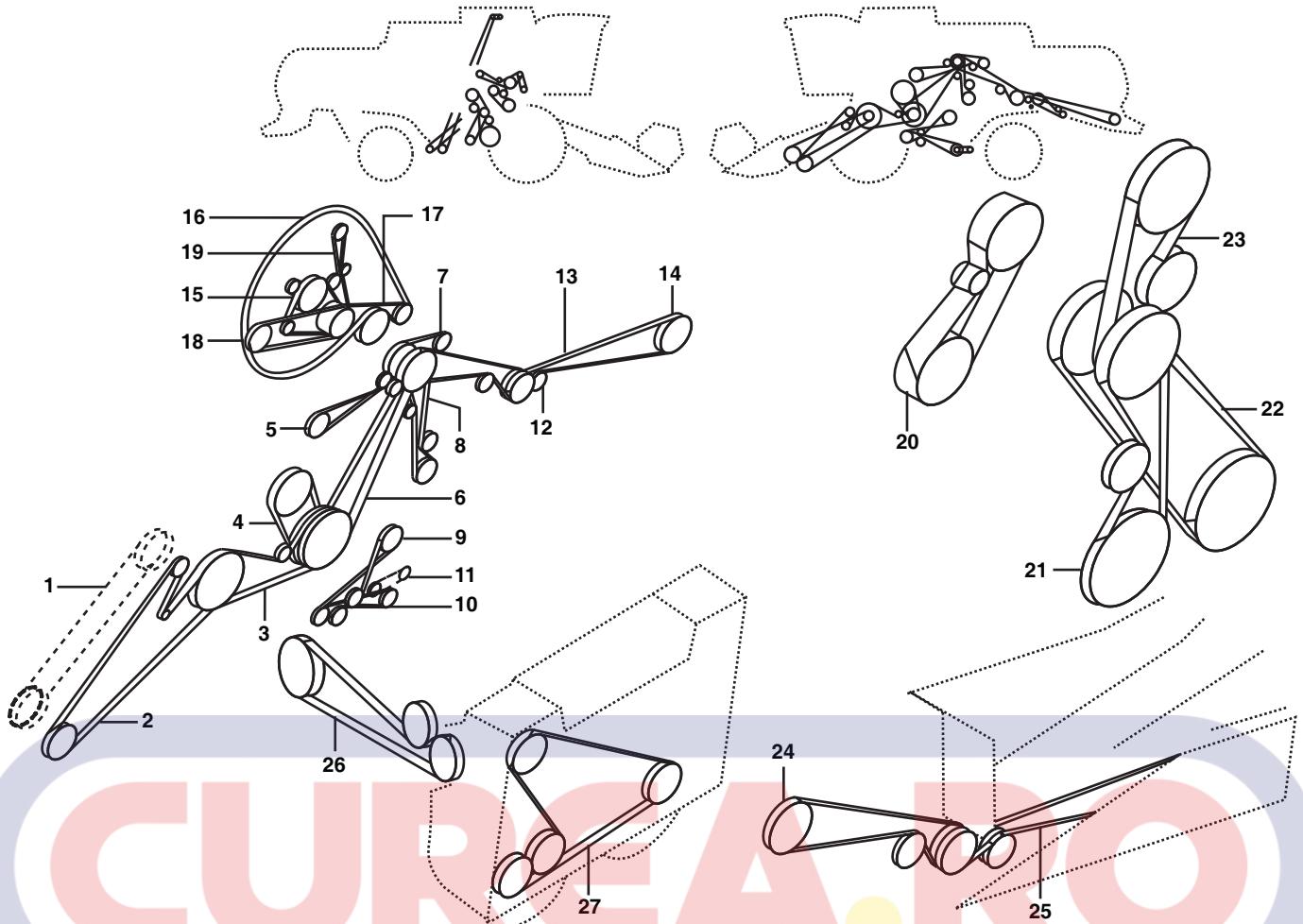

NEW HOLLAND CSX 7050





| Belt No. | | No. of Belts | OEM  Part No. | PIX  Part No. |
|----------|--------------------------------------|--------------|--|--|
| 2 | Straw Elevator Drive, 2HB | 1 | 84981586 | A-84981586 |
| 2 | Straw Elevator Drive, 3HB | 1 | 84991234 | A-84991234 |
| 3 | Header Drive Engaging idler 2HB Only | 1 | 84446792 | A-84446792 |
| 3 | Header Drive Engaging idler 3HB Only | 1 | 89817374 | A-89817374 |
| 4 | Drum Variator | 1 | 84035748 | A-84035748 |
| 5 | Grain Tank Discharge | 1 | 84462590 | A-84462590 |
| 5 | Rotary Screen Drive & Fan | 1 | 747177 | A-747177 |
| 6 | Main Drive | 1 | 84993120 | A-84993120 |
| 7 | Hydrostatic Pump Drive | 1 | 80427456 | A-80427456 |
| 8 | Hydrostatic Pump Drive | 1 | 84607713 | A-84607713 |
| 9 | Straw Walker Drive | 1 | 87521887 | A-87521887 |
| 9 | Grass Seed Equipment | 1 | 84452153 | A-84452153 |
| 10 | Grain Elevator Bottom Auger | 1 | 80422731 | A-80422731 |
| 12 | Chaff Spreader | 1 | 84790244 | A-84790244 |
| 13 | Chopper Drive | 1 | 84075955 | A-84075955 |
| 14 | Chopper Drive | 1 | 84076421 | A-84076421 |
| 15 | Drive, Rotary Screen & Fan | 2 | 84061463 | A-84061463 |
| 16 | Drive, Rotary Screen & Fan | 1 | 87374615 | A-87374615 |
| 17 | Alternator Drive | 1 | 84817626 | A-84817626 |
| 20 | Drum Drive | 1 | 84072772 | A-84072772 |



| Belt No. |  | No. of Belts | OEM  Part No. | PIX  Part No. |
|-----------------|---|---------------------|---|---|
| 20 | Drum Drive, Rotation Speed Slow | 1 | 84072815 | A-84072815 |
| 21 | Straw Shaker Drive | 1 | 84817635 | A-84817635 |
| 22 | Fan Vari-drive | 1 | 84073979 | A-84073979 |
| 23 | Rotary Separator Drive & Shaft | 1 | 84073933 | A-84073933 |
| 24 | Chopper Drive | 1 | 84075955 | A-84075955 |
| 25 | Chopper Drive | 1 | 84076421 | A-84076421 |
| 26 | Chaff Spreader | 1 | 84790244 | A-84790244 |
| 26 | Rotary Screen Drive & Fan | 1 | 84989965 | A-84989965 |
| 27 | Chaff Spreader | 1 | 84790244 | A-84790244 |
| 36 | Grass Seed Equipment | 1 | 84452112 | A-84452112 |
| 36 | Rotary Screen Drive & Fan | 2 | 84061465 | A-84061465 |

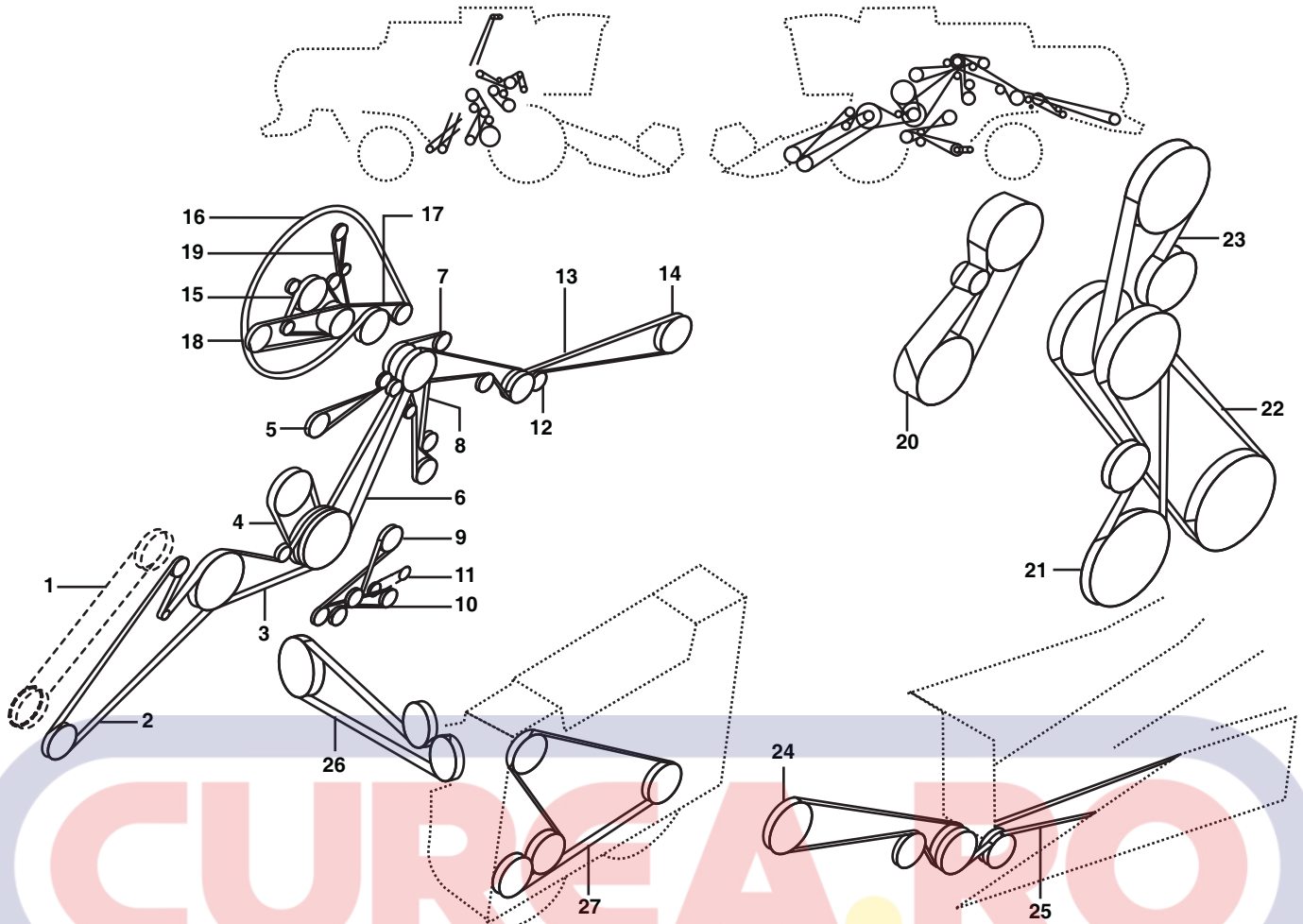

NEW HOLLAND CSX 7050-HILLSIDE





| Belt No. | | No. of Belts | OEM  Part No. | PIX  Part No. |
|----------|--------------------------------------|--------------|--|--|
| 2 | Straw Elevator Drive, 2HB | 1 | 84981586 | A-84981586 |
| 2 | Straw Elevator Drive, 3HB | 1 | 84991234 | A-84991234 |
| 3 | Header Drive Engaging idler 2HB Only | 1 | 84446792 | A-84446792 |
| 3 | Header Drive Engaging idler 3HB Only | 1 | 89817374 | A-89817374 |
| 4 | Drum Variator | 1 | 84035748 | A-84035748 |
| 5 | Grain Tank Discharge | 1 | 84462590 | A-84462590 |
| 5 | Rotary Screen Drive And Fan | 1 | 747177 | A-747177 |
| 6 | Main Drive | 1 | 84993120 | A-84993120 |
| 7 | Hydrostatic Pump Drive | 1 | 80427456 | A-80427456 |
| 8 | Hydrostatic Pump Drive | 1 | 84607713 | A-84607713 |
| 9 | Straw Walker Drive | 1 | 87521887 | A-87521887 |
| 9 | Grass Seed Equipment | 1 | 84452153 | A-84452153 |
| 10 | Grain Elevator Bottom Auger | 1 | 80422731 | A-80422731 |
| 12 | Chaff Spreader | 1 | 84790244 | A-84790244 |
| 13 | Chopper Drive | 1 | 84075955 | A-84075955 |
| 14 | Chopper Drive | 1 | 84076421 | A-84076421 |
| 15 | Drive, Rotary Screen & Fan | 2 | 84061463 | A-84061463 |
| 16 | Drive, Rotary Screen & Fan | 1 | 87374615 | A-87374615 |
| 17 | Alternator Drive | 1 | 84817626 | A-84817626 |



| Belt No. |  | No. of Belts | OEM  Part No. | PIX  Part No. |
|----------|---|--------------|--|--|
| 20 | Drum Drive | 1 | 84072772 | A-84072772 |
| 20 | Drum Drive, Rotation Speed Slow | 1 | 84072815 | A-84072815 |
| 21 | Straw Shaker Drive | 1 | 84817635 | A-84817635 |
| 22 | Fan Vari-drive | 1 | 84073979 | A-84073979 |
| 23 | Rotary Separator Drive & Shaft | 1 | 84073933 | A-84073933 |
| 24 | Chopper Drive | 1 | 84075955 | A-84075955 |
| 25 | Chopper Drive | 1 | 84076421 | A-84076421 |
| 26 | Chaff Spreader | 1 | 84790244 | A-84790244 |
| 26 | Rotary Screen Drive & Fan | 1 | 84989965 | A-84989965 |
| 27 | Chaff Spreader | 1 | 84790244 | A-84790244 |
| 36 | Grass Seed Equipment | 1 | 84452112 | A-84452112 |
| 36 | Rotary Screen Drive & Fan | 2 | 84061465 | A-84061465 |

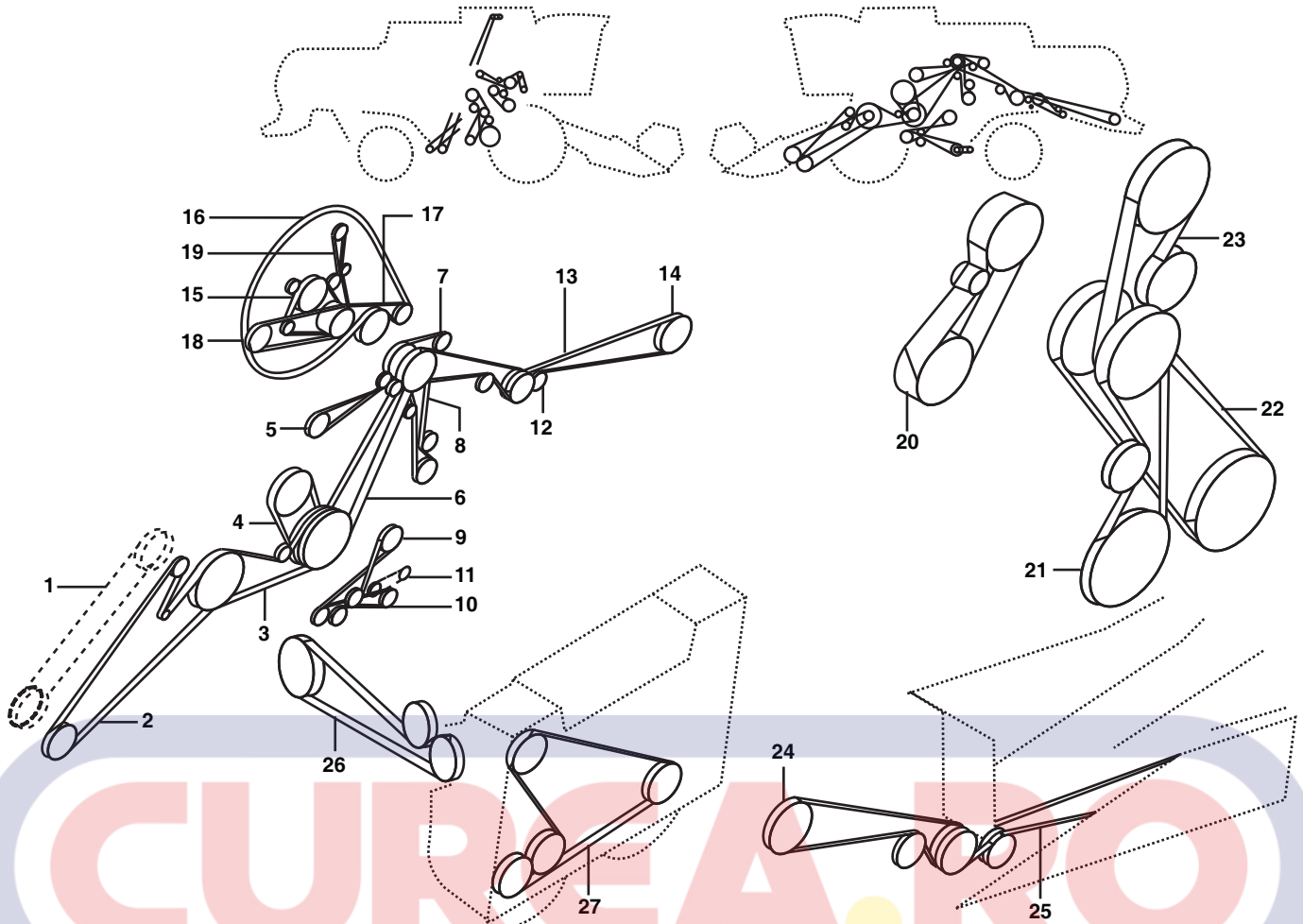

NEW HOLLAND CSX 7060



| Belt No. | | No. of Belts | OEM  Part No. | PIX  Part No. |
|----------|--------------------------------------|--------------|--|--|
| 2 | Straw Elevator Drive, 2HB | 1 | 84981586 | A-84981586 |
| 2 | Straw Elevator Drive, 3HB | 1 | 84991234 | A-84991234 |
| 3 | Header Drive Engaging idler 2HB Only | 1 | 84446792 | A-84446792 |
| 3 | Header Drive Engaging idler 3HB Only | 1 | 89817374 | A-89817374 |
| 4 | Drum Variator | 1 | 84035748 | A-84035748 |
| 5 | Grain Tank Discharge | 1 | 84462590 | A-84462590 |
| 5 | Rotary Screen Drive and Fan | 1 | 747177 | A-747177 |
| 6 | Main Drive | 1 | 84993120 | A-84993120 |
| 7 | Hydrostatic Pump Drive | 1 | 80427456 | A-80427456 |
| 8 | Hydrostatic Pump Drive | 1 | 84607712 | A-84607712 |
| 9 | Straw Walker Drive | 1 | 87521887 | A-87521887 |
| 9 | Grass Seed Equipment | 1 | 84452153 | A-84452153 |
| 10 | Grain Elevator Bottom Auger | 1 | 80422731 | A-80422731 |
| 12 | Chaff Spreader | 1 | 84790244 | A-84790244 |
| 13 | Chopper Drive | 1 | 84075955 | A-84075955 |
| 14 | Chopper Drive | 1 | 84076421 | A-84076421 |
| 15 | Drive, Rotary Screen and Fan | 2 | 84061463 | A-84061463 |
| 16 | Drive, Rotary Screen and Fan | 1 | 87374615 | A-87374615 |
| 17 | Alternator Drive | 1 | 84817626 | A-84817626 |



| Belt No. |  | No. of Belts | OEM  Part No. | PIX  Part No. |
|----------|---|--------------|--|--|
| 20 | Drum Drive | 1 | 84072772 | A-84072772 |
| 20 | Drum Drive, Rotation Speed Slow | 1 | 84072815 | A-84072815 |
| 21 | Straw Shaker Drive | 1 | 84817635 | A-84817635 |
| 22 | Fan Vari-drive | 1 | 84073979 | A-84073979 |
| 23 | Rotary Separator Drive And Shaft | 1 | 84073933 | A-84073933 |
| 24 | Chopper Drive | 1 | 84075955 | A-84075955 |
| 25 | Chopper Drive | 1 | 84076421 | A-84076421 |
| 26 | Chaff Spreader | 1 | 84790244 | A-84790244 |
| 27 | Chaff Spreader | 1 | 84790355 | A-84790355 |
| 36 | Grass Seed Equipment | 1 | 84452112 | A-84452112 |
| 36 | Rotary Screen Drive And Fan | 2 | 84061465 | A-84061465 |

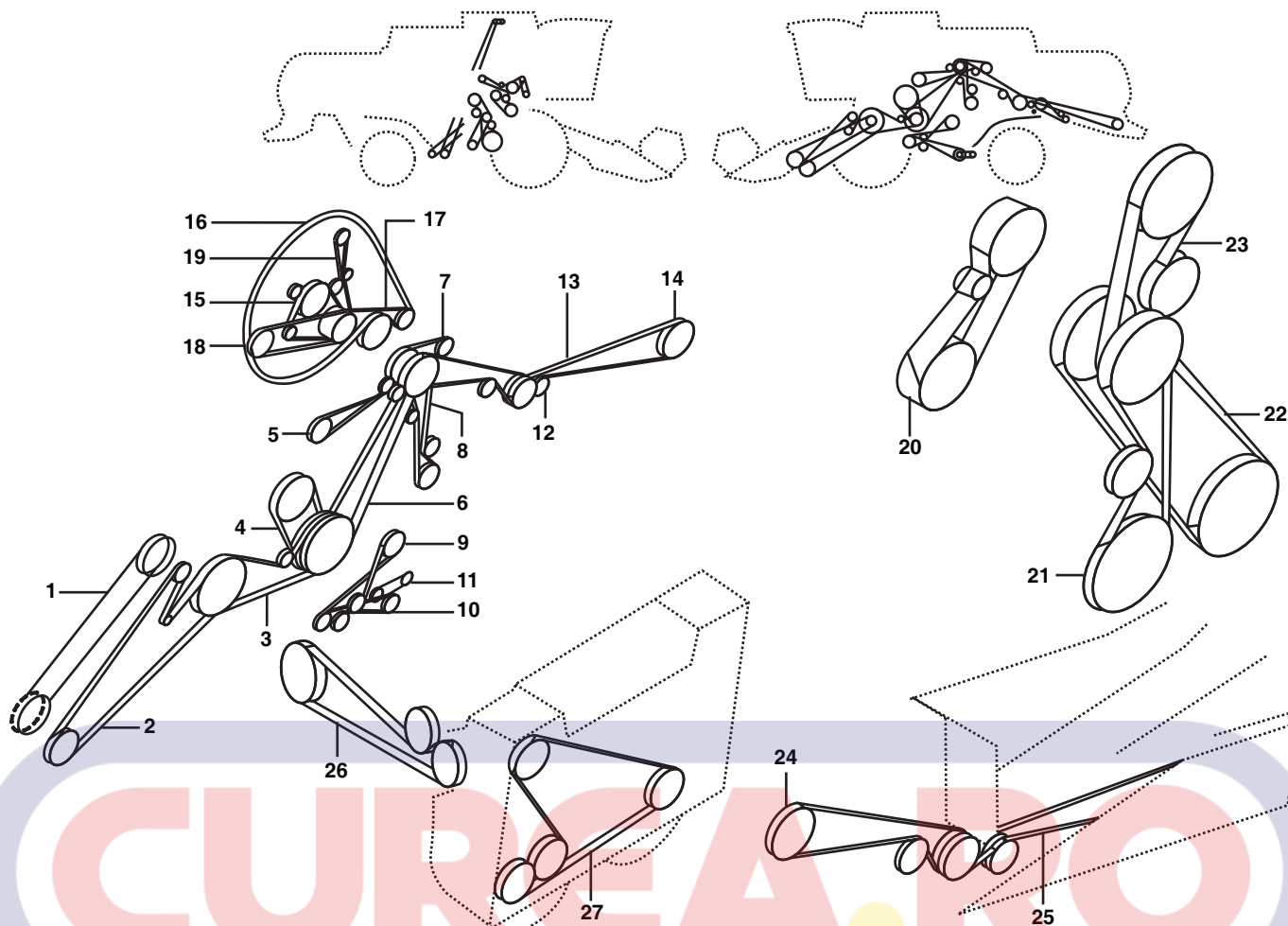

NEW HOLLAND CSX 7070





| Belt No. | | No. of Belts | OEM Part No. | PIX Part No. |
|----------|--------------------------------------|--------------|--------------|--------------|
| 2 | Straw Elevator Drive, 2HB | 1 | 84981586 | A-84981586 |
| 2 | Straw Elevator Drive, 3HB | 1 | 84991234 | A-84991234 |
| 3 | Header Drive Engaging idler 2HB Only | 1 | 84446792 | A-84446792 |
| 3 | Header Drive Engaging idler 3HB Only | 1 | 89817374 | A-89817374 |
| 4 | Drum Variator | 1 | 84035748 | A-84035748 |
| 5 | Grain Tank Discharge | 1 | 84462590 | A-84462590 |
| 5 | Rotary Screen Drive and Fan | 1 | 747177 | A-747177 |
| 6 | Main Drive | 1 | 84993120 | A-84993120 |
| 7 | Hydrostatic Pump Drive | 1 | 80427456 | A-80427456 |
| 8 | Hydrostatic Pump Drive | 1 | 84607712 | A-84607712 |
| 9 | Straw Walker Drive | 1 | 87521887 | A-87521887 |
| 9 | Grass Seed Equipment | 1 | 84452153 | A-84452153 |
| 10 | Grain Elevator Bottom Auger | 1 | 80422731 | A-80422731 |
| 12 | Chaff Spreader | 1 | 84790244 | A-84790244 |
| 13 | Chopper Drive | 1 | 84075955 | A-84075955 |
| 14 | Chopper Drive | 1 | 84076421 | A-84076421 |
| 15 | Drive, Rotary Screen and Fan | 2 | 84061463 | A-84061463 |
| 16 | Drive, Rotary Screen and Fan | 1 | 87374615 | A-87374615 |
| 17 | Alternator Drive | 1 | 84817626 | A-84817626 |
| 20 | Drum Drive | 1 | 84072772 | A-84072772 |



| Belt No. |  | No. of Belts | OEM  Part No. | PIX  Part No. |
|----------|---|--------------|--|--|
| 20 | Drum Drive, Rotation Speed Slow | 1 | 84072815 | A-84072815 |
| 21 | Straw Shaker Drive | 1 | 84817635 | A-84817635 |
| 22 | Fan Vari-drive | 1 | 84073979 | A-84073979 |
| 23 | Rotary Separator Drive And Shaft | 1 | 84073933 | A-84073933 |
| 24 | Chopper Drive | 1 | 84075955 | A-84075955 |
| 25 | Chopper Drive | 1 | 84076421 | A-84076421 |
| 26 | Chaff Spreader | 1 | 84790244 | A-84790244 |
| 26 | Rotary Screen Drive And Fan | 1 | 84989965 | A-84989965 |
| 27 | Chaff Spreader | 1 | 84790244 | A-84790244 |
| 36 | Grass Seed Equipment | 1 | 84452112 | A-84452112 |
| 36 | Rotary Screen Drive And Fan | 2 | 84061465 | A-84061465 |

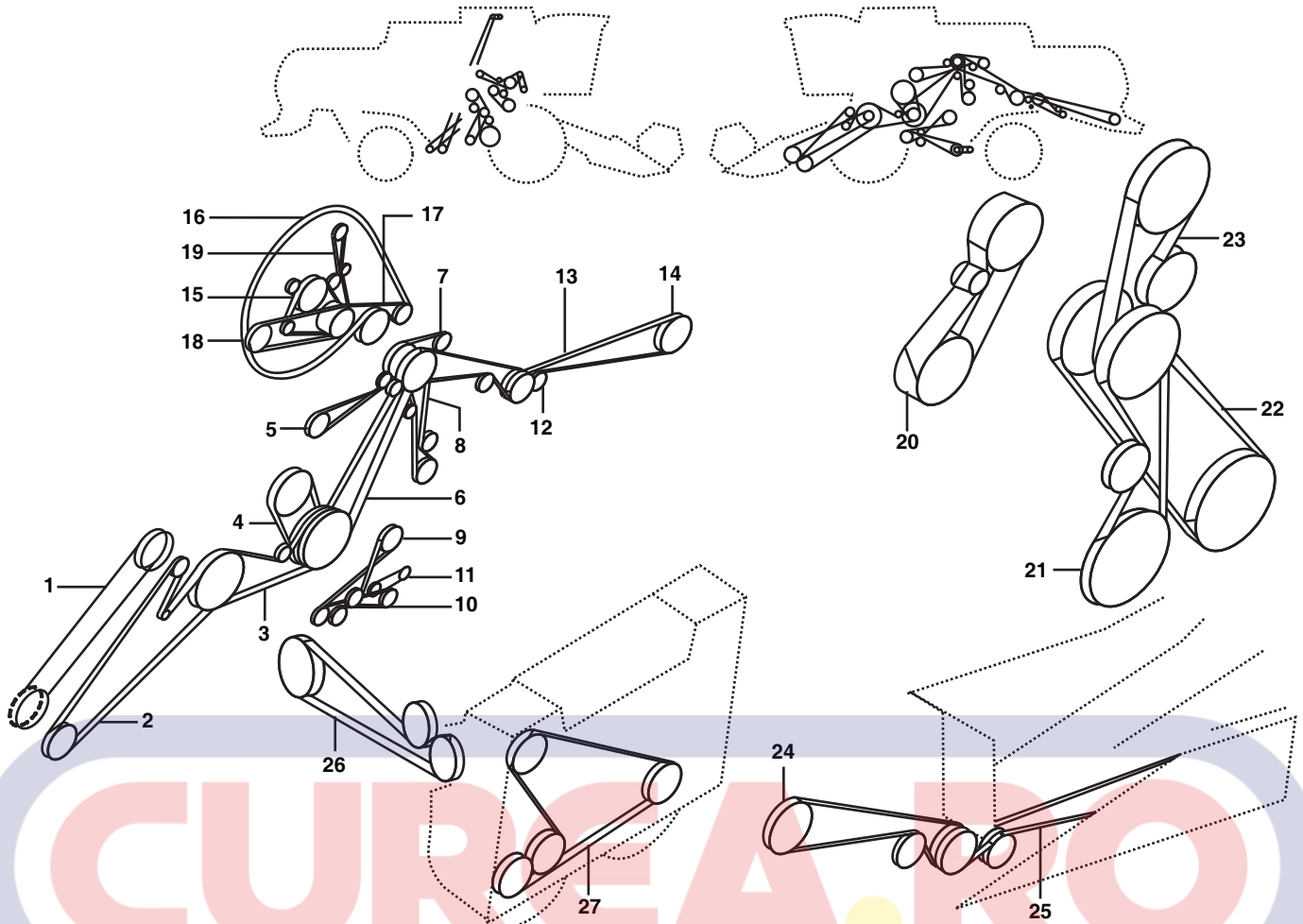

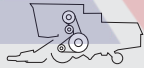
NEW HOLLAND CSX 7080





| Belt No. |  | No. of Belts | OEM  Part No. | PIX  Part No. |
|----------|---|--------------|--|--|
| 2 | Straw Elevator Drive, 2HB | 1 | 84981586 | A-84981586 |
| 2 | Straw Elevator Drive, 3HB | 1 | 84991234 | A-84991234 |
| 3 | Header Drive Engaging idler 2HB Only | 1 | 84446792 | A-84446792 |
| 3 | Header Drive Engaging idler 3HB Only | 1 | 89817374 | A-89817374 |
| 4 | Drum Variator | 1 | 84035748 | A-84035748 |
| 5 | Grain Tank Discharge | 1 | 84462590 | A-84462590 |
| 6 | Main Drive | 1 | 84993120 | A-84993120 |
| 7 | Hydrostatic Pump Drive | 1 | 80427456 | A-80427456 |
| 8 | Hydrostatic Pump Drive | 1 | 84607713 | A-84607713 |
| 9 | Straw Walker Drive | 1 | 87521887 | A-87521887 |
| 10 | Grain Elevator Bottom Auger | 1 | 80422731 | A-80422731 |
| 12 | Chaff Spreader | 1 | 84790244 | A-84790244 |
| 13 | Chopper Drive | 1 | 84075955 | A-84075955 |
| 14 | Chopper Drive | 1 | 84076421 | A-84076421 |
| 15 | Drive, Rotary Screen And Fan | 2 | 84061463 | A-84061463 |
| 16 | Drive, Rotary Screen And Fan | 1 | 87374615 | A-87374615 |
| 17 | Alternator Drive | 1 | 84817626 | A-84817626 |
| 20 | Drum Drive | 1 | 84072772 | A-84072772 |
| 20 | Drum Drive, Rotation Speed Slow | 1 | 84072815 | A-84072815 |



| Belt No. |  | No. of Belts | OEM  Part No. | PIX  Part No. |
|----------|---|--------------|--|--|
| 21 | Straw Shaker Drive | 1 | 84817635 | A-84817635 |
| 22 | Fan Vari-drive | 1 | 84073979 | A-84073979 |
| 23 | Rotary Separator Drive And Shaft | 1 | 84073933 | A-84073933 |
| 24 | Chopper Drive | 1 | 84075955 | A-84075955 |
| 25 | Chopper Drive | 1 | 84076421 | A-84076421 |
| 26 | Chaff Spreader | 1 | 84790244 | A-84790244 |
| 27 | Chaff Spreader | 1 | 84790356 | A-84790356 |
| 36 | Grass Seed Equipment | 1 | 84452112 | A-84452112 |
| 36 | Rotary Screen Drive And Fan | 2 | 84061465 | A-84061465 |

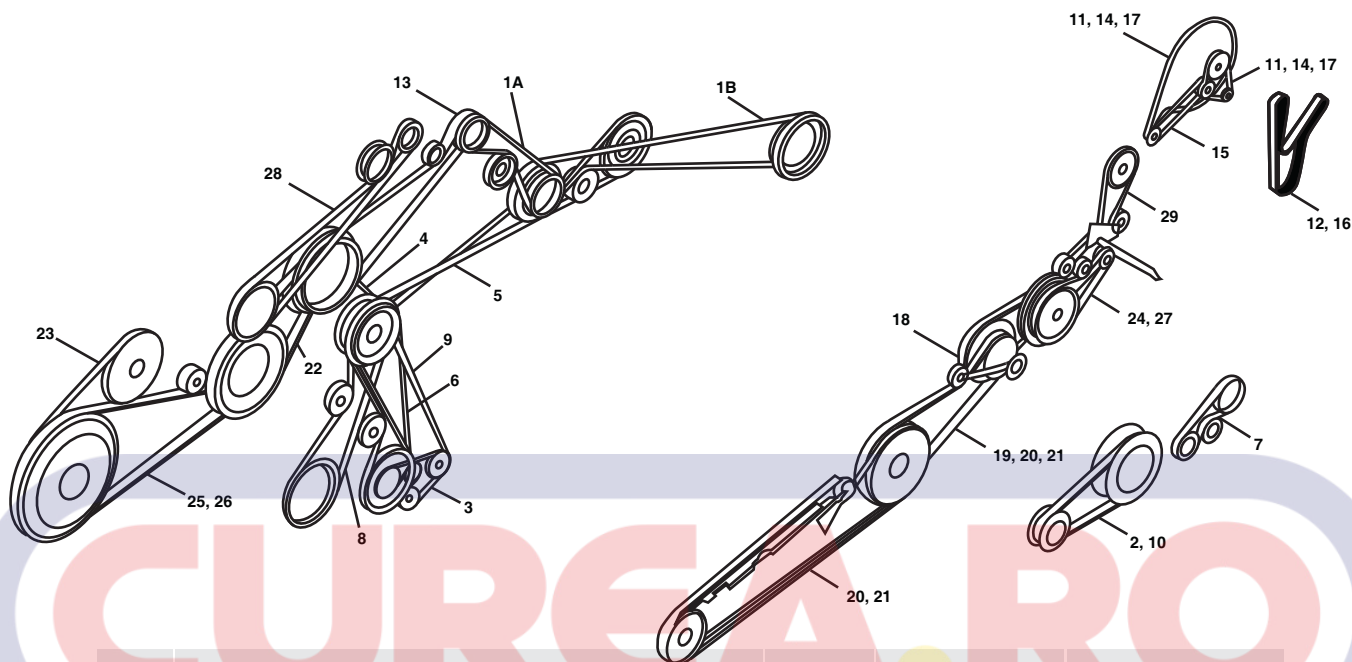
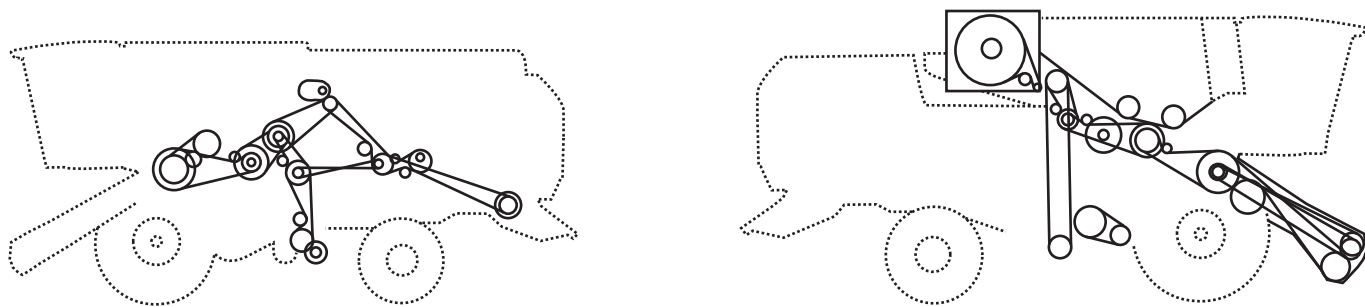

NEW HOLLAND CX 720





| Belt No. | | No. of Belts | OEM  Part No. | PIX  Part No. |
|----------|--|--------------|--|--|
| 1A | Chopper Drive | 1 | 84075345 | A-84075345 |
| 1B | Chopper Drive | 1 | 84075635 | A-84075635 |
| 2 | Grass Seed Equipment - Accessories for Self Levelling Only | 1 | 84023277 | A-84023277 |
| 2 | Grass Seed Equipment - Accessories for Fixed Shoe Only | 1 | 84023278 | A-84023278 |
| 3 | Shaker Shoe Drive - Self-levelling | 2 | 84056913 | A-84056913 |
| 4 | Intermediate Shaft - Cleaning Drive | 1 | 84057392 | A-84057392 |
| 5 | Straw Walker Drive | 1 | 84057482 | A-84057482 |
| 6 | Shaker Shoe & Tailings Elevator Drive - Self Levelling | 1 | 84057874 | A-84057874 |
| 7 | Tailings Elevators - Bottom Auger & (Right Hand)drive | 2 | 84058339 | A-84058339 |
| 8 | Shaker Shoe Drive - Fixed Shoe | 1 | 84432785 | A-84432785 |
| 9 | Tailings Elevator Drive - Fixed Shoe | 1 | 84435035 | A-84435035 |
| 10 | Main Fan Variable Speed Drive for Self Levelling Only | 1 | 9502654 | A-9502654 |
| 10 | Main Fan Variable Speed Drive for Fixed Shoe Only | 1 | 919739 | A-919739 |
| 11 | Rotary Screen And Fan | 1 | 84057085 | A-84057085 |
| 12 | Alternator, Waterpump And Air Compressor | 1 | 84057710 | A-84057710 |
| 13 | Main Drive | 1 | 84057914 | A-84057914 |
| 14 | Rotary Screen And Fan | 2 | 84061465 | A-84061465 |
| 15 | Blow-off System, Air Compressor | 2 | 84061465 | A-84061465 |
| 17 | Rotary Screen And Fan, For High Speed Fanonly | 2 | 87337385 | A-87337385 |



| Belt No. |  | No. of Belts | OEM  Part No. | PIX  Part No. |
|-----------------|---|---------------------|---|---|
| 17 | Rotary Screen And Fan | 2 | 9835816 | A-9835816 |
| 18 | Header Drive | 1 | 84061279 | A-84061279 |
| 19 | Straw Elevator Drive | 1 | 84334995 | A-84334995 |
| 20 | Straw Elevator Drive | 1 | 84434260 | A-84434260 |
| 21 | Straw Elevator Drive | 1 | 84434295 | A-84434295 |
| 22 | Drum Drive Variable Speed | 1 | 84035748 | A-84035748 |
| 23 | Beater Drive | 1 | 84045256 | A-84045256 |
| 24 | Rotary Separator Drive And Shaft | 1 | 84057393 | A-84057393 |
| 25 | Drum Drive With Reductor | 1 | 84061615 | A-84061615 |
| 27 | Rotary Separator Drive Andshaft | 1 | 84457079 | A-84457079 |
| 28 | Unloading Auger Drive | 1 | 84061293 | A-84061293 |
| 29 | Elevator Drive Grain | 1 | 84073457 | A-84073457 |

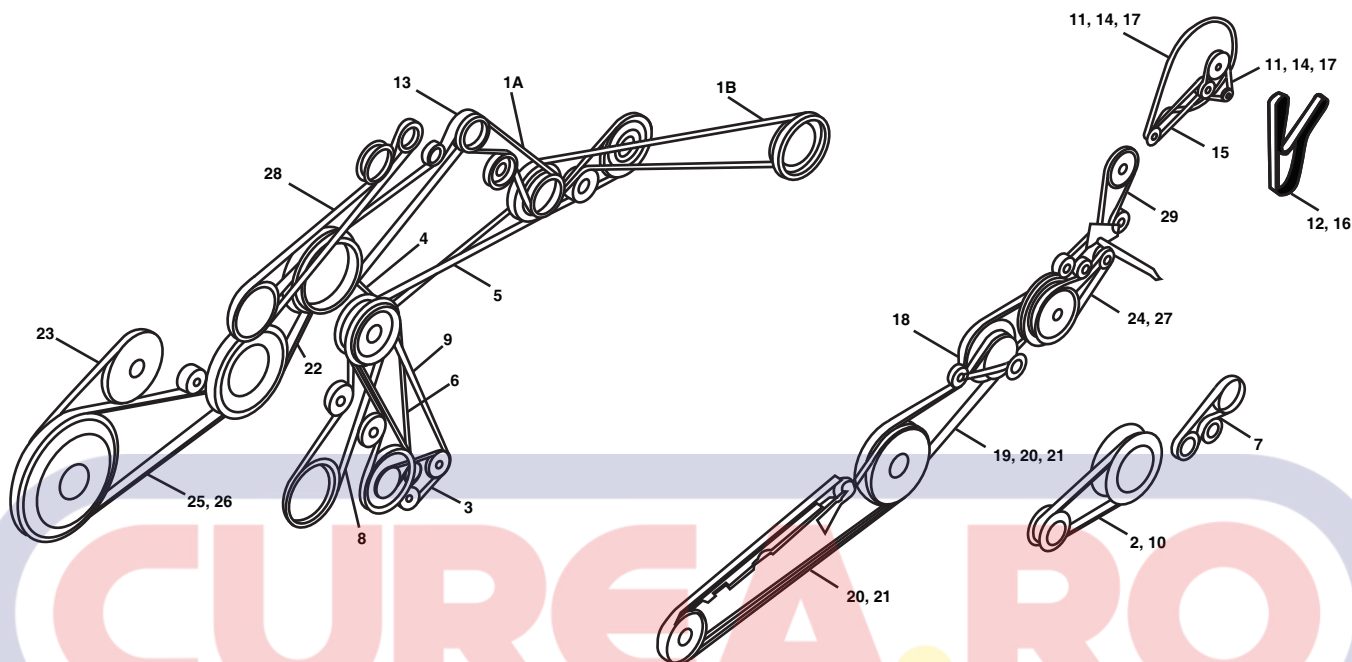
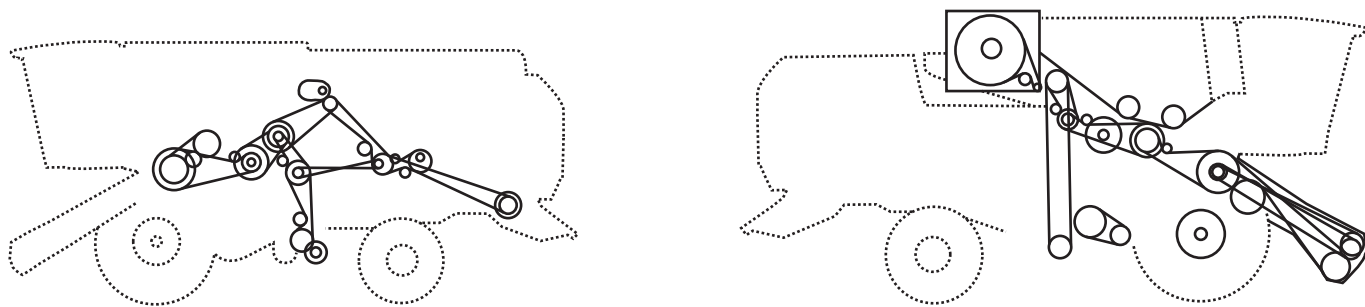

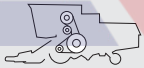
NEW HOLLAND CX 740



| Belt No. |  | No. of Belts | OEM  Part No. | PIX  Part No. |
|----------|---|--------------|--|--|
| 1A | Chopper Drive | 1 | 84075345 | A-84075345 |
| 1B | Chopper Drive | 1 | 84075635 | A-84075635 |
| 2 | Grass Seed Equipment - Accessories For Self Levelling Only | 1 | 84023277 | A-84023277 |
| 2 | Grass Seed Equipment - Accessories For Fixed Shoe Only | 1 | 84023278 | A-84023278 |
| 3 | Shaker Shoe Drive - Self-levelling | 2 | 84056913 | A-84056913 |
| 4 | Intermediate Shaft - Cleaning Drive | 1 | 84057392 | A-84057392 |
| 5 | Straw Walker Drive | 1 | 84057482 | A-84057482 |
| 6 | Shaker Shoe & Tailings Elevator Drive - Self Levelling | 1 | 84057874 | A-84057874 |
| 7 | Tailings Elevators - Bottom Auger & (R/H)drive | 2 | 84058339 | A-84058339 |
| 8 | Shaker Shoe Drive - Fixed Shoe | 1 | 84432785 | A-84432785 |
| 9 | Tailings Elevator Drive - Fixed Shoe | 1 | 84435035 | A-84435035 |
| 10 | Main Fan Variable Speed Drive For Self Levelling Only | 1 | 9502654 | A-9502654 |
| 10 | Main Fan Variable Speed Drive For Fixed Shoe Only | 1 | 919739 | A-919739 |
| 11 | Rotary Screen And Fan | 1 | 84057085 | A-84057085 |
| 12 | Alternator, Water pump & Air Compressor | 1 | 84057710 | A-84057710 |
| 13 | Main Drive | 1 | 84057914 | A-84057914 |
| 14 | Rotary Screen & Fan | 2 | 84061465 | A-84061465 |
| 15 | Blow-off System, Air Compressor | 2 | 84061465 | A-84061465 |



| Belt No. |  | No. of Belts | OEM  Part No. | PIX  Part No. |
|----------|---|--------------|--|--|
| 17 | Rotary Screen & Fan, For High Speed Fan only | 2 | 87337385 | A-87337385 |
| 17 | Rotary Screen & Fan | 2 | 9835816 | A-9835816 |
| 18 | Header Drive | 1 | 84061279 | A-84061279 |
| 19 | Straw Elevator Drive | 1 | 84334995 | A-84334995 |
| 20 | Straw Elevator Drive | 1 | 84434260 | A-84434260 |
| 21 | Straw Elevator Drive | 1 | 84434295 | A-84434295 |
| 22 | Drum Drive Variable Speed | 1 | 84035748 | A-84035748 |
| 23 | Beater Drive | 1 | 84045256 | A-84045256 |
| 24 | Rotary Separator Drive & Shaft | 1 | 84057393 | A-84057393 |
| 25 | Drum Drive With Reductor | 1 | 84061615 | A-84061615 |
| 27 | Rotary Separator Drive & shaft | 1 | 84457079 | A-84457079 |
| 28 | Unloading Auger Drive | 1 | 84061293 | A-84061293 |
| 29 | Elevator Drive Grain | 1 | 84073457 | A-84073457 |

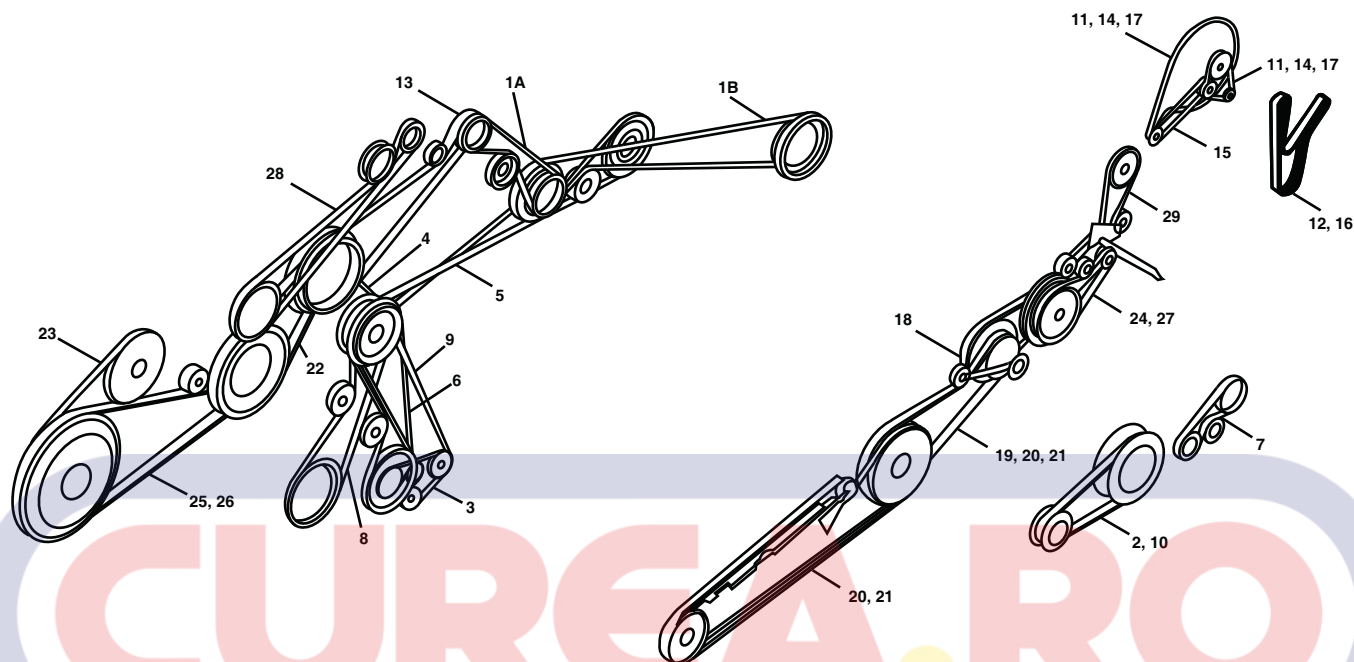
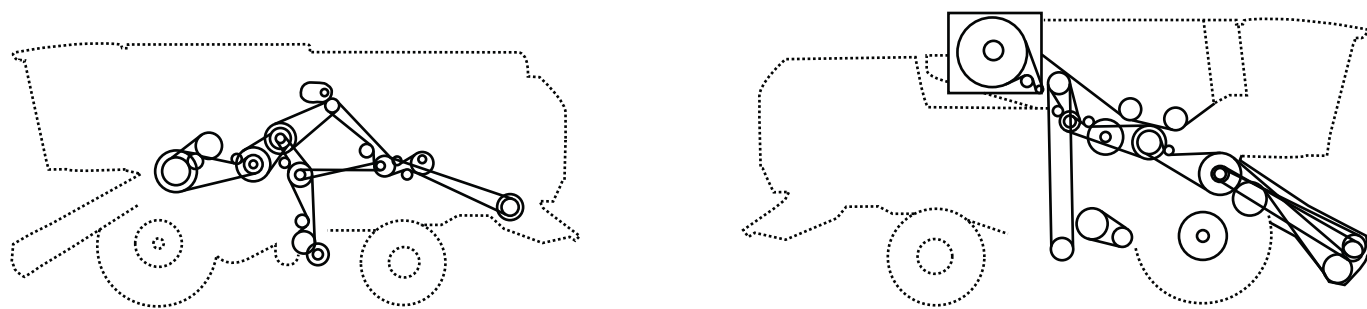

NEW HOLLAND CX 760







| Belt No. | | No. of Belts | OEM  Part No. | PIX  Part No. |
|----------|--|--------------|--|--|
| 1A | Chopper Drive | 1 | 84075345 | A-84075345 |
| 1B | Chopper Drive | 1 | 84075635 | A-84075635 |
| 2 | Grass Seed Equipment - Accessories For Self Levelling Only | 1 | 84023277 | A-84023277 |
| 2 | Grass Seed Equipment - Accessories For Fixed Shoe Only | 1 | 84023278 | A-84023278 |
| 3 | Shaker Shoe Drive - Self-levelling | 2 | 84056913 | A-84056913 |
| 4 | Intermediate Shaft - Cleaning Drive | 1 | 84057392 | A-84057392 |
| 5 | Straw Walker Drive | 1 | 84057482 | A-84057482 |
| 6 | Shaker Shoe & Tailings Elevator Drive - Self Levelling | 1 | 84057874 | A-84057874 |
| 7 | Tailings Elevators - Bottom Auger & (right Hand)drive | 2 | 84058339 | A-84058339 |
| 8 | Shaker Shoe Drive - Fixed Shoe | 1 | 84432785 | A-84432785 |
| 9 | Tailings Elevator Drive - Fixed Shoe | 1 | 84435035 | A-84435035 |
| 10 | Main Fan Variable Speed Drive For Self Levelling Only | 1 | 9502654 | A-9502654 |
| 10 | Main Fan Variable Speed Drive For Fixed Shoe Only | 1 | 919739 | A-919739 |
| 11 | Rotary Screen And Fan | 1 | 84057085 | A-84057085 |
| 12 | Alternator, Waterpump And Air Compressor | 1 | 84057710 | A-84057710 |
| 13 | Main Drive | 1 | 84057914 | A-84057914 |
| 14 | Rotary Screen And Fan | 2 | 84061465 | A-84061465 |
| 15 | Blow-off System, Air Compressor | 2 | 84061465 | A-84061465 |
| 17 | Rotary Screen And Fan, For High Speed Fanonly | 2 | 87337385 | A-87337385 |

| Belt No. |  | No. of Belts | OEM  Part No. | PIX  Part No. |
|----------|---|--------------|--|--|
| 17 | Rotary Screen And Fan | 2 | 9835816 | A-9835816 |
| 18 | Header Drive | 1 | 84061279 | A-84061279 |
| 19 | Straw Elevator Drive | 1 | 84334995 | A-84334995 |
| 20 | Straw Elevator Drive | 1 | 84434260 | A-84434260 |
| 21 | Straw Elevator Drive | 1 | 84434295 | A-84434295 |
| 22 | Drum Drive Variable Speed | 1 | 84035748 | A-84035748 |
| 23 | Beater Drive | 1 | 84045256 | A-84045256 |
| 24 | Rotary Separator Drive And Shaft | 1 | 84057393 | A-84057393 |
| 25 | Drum Drive With Reductor | 1 | 84061615 | A-84061615 |
| 27 | Rotary Separator Drive Andshaft | 1 | 84457079 | A-84457079 |
| 28 | Unloading Auger Drive | 1 | 84061293 | A-84061293 |
| 29 | Elevator Drive Grain | 1 | 84073457 | A-84073457 |







AGCO

| OEM | OEM  Part No. | PIX  Part No. |
|------|--|--|
| AGCO | 789931M1 | A-789931M1 |
| AGCO | 4311315 | A-4311315 |
| AGCO | 340433154 | A-340433154 |
| AGCO | 433531 | A-433531 |
| AGCO | 435125 | A-435125 |
| AGCO | 340435155 | A-340435155 |
| AGCO | 340433197 | A-340433197 |
| AGCO | 340433198 | A-340433198 |
| AGCO | 789967M1 | A-789967M1 |
| AGCO | 344311230 | A-344311230 |
| AGCO | 340433045 | A-340433045 |
| AGCO | 87800127 | A-87800127 |
| AGCO | 432244 | A-432244 |
| AGCO | 433417 | A-433417 |
| AGCO | 433537 | A-433537 |
| AGCO | 71161595 | A-71161595 |
| AGCO | 71161596 | A-71161596 |
| AGCO | 71164350 | A-71164350 |
| AGCO | 71165927 | A-71165927 |
| AGCO | 71167409 | A-71167409 |
| AGCO | 71197999 | A-71197999 |
| AGCO | 71310380 | A-71310380 |
| AGCO | 71310381 | A-71310381 |
| AGCO | 71310382 | A-71310382 |
| AGCO | 71322834 | A-71322834 |
| AGCO | 71324690 | A-71324690 |
| AGCO | 71339886 | A-71339886 |
| AGCO | 71347560 | A-71347560 |
| AGCO | 71347561 | A-71347561 |
| AGCO | 71348999 | A-71348999 |
| AGCO | 71356409 | A-71356409 |
| AGCO | 71364922 | A-71364922 |
| AGCO | 226981M1 | A-226981M1 |
| AGCO | 1720255M1 | A-1720255M1 |
| AGCO | 1724154M1 | A-1724154M1 |
| AGCO | 265522M91 | A-265522M91 |
| AGCO | 402607M1 | A-402607M1 |
| AGCO | 833868M2 | A-833868M2 |
| AGCO | 833873M1 | A-833873M1 |
| AGCO | 843310M1 | A-843310M1 |
| AGCO | 71118003 | A-71118003 |
| AGCO | 71139962 | A-71139962 |
| AGCO | 71173472 | A-71173472 |
| AGCO | 71305994 | A-71305994 |
| AGCO | 71326830 | A-71326830 |
| AGCO | 71139966 | A-71139966 |
| AGCO | 71170690 | A-71170690 |



| OEM | OEM  Part No. | PIX  Part No. |
|------|--|--|
| AGCO | 71342142 | A-71342142 |
| AGCO | 71342143 | A-71342143 |
| AGCO | 526369 | A-526369 |
| AGCO | 855122 | A-855122 |
| AGCO | 1710292 | A-1710292 |
| AGCO | 71132108 | A-71132108 |
| AGCO | 71147547 | A-71147547 |
| AGCO | 71164177 | A-71164177 |
| AGCO | 71175575 | A-71175575 |
| AGCO | 71175989 | A-71175989 |
| AGCO | 71176492 | A-71176492 |
| AGCO | 71177537 | A-71177537 |
| AGCO | 71187728 | A-71187728 |
| AGCO | 71187779 | A-71187779 |
| AGCO | 71300867 | A-71300867 |
| AGCO | 71309150 | A-71309150 |
| AGCO | 71309685 | A-71309685 |
| AGCO | 71322828 | A-71322828 |
| AGCO | 71325150 | A-71325150 |
| AGCO | 71359598 | A-71359598 |
| AGCO | 71448483 | A-71448483 |
| AGCO | 700705430 | A-700705430 |
| AGCO | 700711852 | A-700711852 |
| AGCO | 1036940M1 | A-1036940M1 |
| AGCO | 71432802 | A-71432802 |
| AGCO | 842413M2 | A-842413M2 |
| AGCO | 41975300 | A-41975300 |
| AGCO | 509572M1 | A-509572M1 |
| AGCO | 531371M1 | A-531371M1 |
| AGCO | 621259M1 | A-621259M1 |
| AGCO | 832789M3 | A-832789M3 |
| AGCO | 833855M1 | A-833855M1 |
| AGCO | 833874M1 | A-833874M1 |
| AGCO | 3617180M91 | A-3617180M91 |
| AGCO | 71194500 | A-71194500 |
| AGCO | 71135618 | A-71135618 |
| AGCO | 71157414 | A-71157414 |
| AGCO | 71167114 | A-71167114 |
| AGCO | 71300996 | A-71300996 |
| AGCO | 700705773 | A-700705773 |
| AGCO | 621646M1 | A-621646M1 |
| AGCO | 834110M1 | A-834110M1 |
| AGCO | 834174M1 | A-834174M1 |
| AGCO | D41981200 | A-D41981200 |
| AGCO | 417974M1 | A-417974M1 |
| AGCO | 3614706M92 | A-3614706M92 |
| AGCO | 71336307 | A-71336307 |



AGCO

| OEM | OEM  Part No. | PIX  Part No. |
|------|--|--|
| AGCO | 1447778M91 | A-1447778M91 |
| AGCO | 1693746M1 | A-1693746M1 |
| AGCO | 3582952M1 | A-3582952M1 |
| AGCO | 3637306M91 | A-3637306M91 |
| AGCO | 72099473 | A-72099473 |
| AGCO | 71146659 | A-71146659 |
| AGCO | 855635 | A-855635 |
| AGCO | 905921M1 | A-905921M1 |
| AGCO | 71318378 | A-71318378 |
| AGCO | 71188155 | A-71188155 |
| AGCO | 82850751 | A-82850751 |
| AGCO | 855718 | A-855718 |
| AGCO | 70260149 | A-70260149 |
| AGCO | 70267630 | A-70267630 |
| AGCO | 70268485 | A-70268485 |
| AGCO | 70273193 | A-70273193 |
| AGCO | 71139963 | A-71139963 |
| AGCO | 71193749 | A-71193749 |
| AGCO | 71302482 | A-71302482 |
| AGCO | 71309140 | A-71309140 |
| AGCO | 71317254 | A-71317254 |
| AGCO | 71444986 | A-71444986 |
| AGCO | 72501439 | A-72501439 |
| AGCO | 3435748M1 | A-3435748M1 |
| AGCO | 515382M1 | A-515382M1 |
| AGCO | 1612892M91 | A-1612892M91 |
| AGCO | 1686616M91 | A-1686616M91 |
| AGCO | 1690692M1 | A-1690692M1 |
| AGCO | 2801859M1 | A-2801859M1 |
| AGCO | 3383044M91 | A-3383044M91 |
| AGCO | 3612115M1 | A-3612115M1 |
| AGCO | 517951M91 | A-517951M91 |
| AGCO | 518506M92 | A-518506M92 |
| AGCO | 1688988M1 | A-1688988M1 |
| AGCO | 1693745M1 | A-1693745M1 |
| AGCO | 3637597M1 | A-3637597M1 |
| AGCO | 515383M1 | A-515383M1 |
| AGCO | 433435 | A-433435 |
| AGCO | 434140 | A-434140 |
| AGCO | 4311316 | A-4311316 |
| AGCO | 418232M1 | A-418232M1 |
| AGCO | 890982M1 | A-890982M1 |
| AGCO | Cg350620001 | A-CG350620001 |
| AGCO | Sm1675342 | A-SM1675342 |
| AGCO | Sm1713549 | A-SM1713549 |
| AGCO | Sm1716854 | A-SM1716854 |
| AGCO | Sm1716959 | A-SM1716959 |



| OEM | OEM  Part No. | PIX  Part No. |
|------|--|--|
| AGCO | Sm1725557 | A-SM1725557 |
| AGCO | 1604401M1 | A-1604401M1 |
| AGCO | 410647M1 | A-410647M1 |
| AGCO | Cg350628130 | A-CG350628130 |
| AGCO | Cg350628140 | A-CG350628140 |
| AGCO | D41928800 | A-D41928800 |
| AGCO | D41934800 | A-D41934800 |
| AGCO | D41978600 | A-D41978600 |
| AGCO | 3170530M1 | A-3170530M1 |
| AGCO | 916801M2 | A-916801M2 |
| AGCO | D41990069 | A-D41990069 |
| AGCO | D41990053 | A-D41990053 |
| AGCO | 433440 | A-433440 |
| AGCO | 410617M1 | A-410617M1 |
| AGCO | D41998900 | A-D41998900 |
| AGCO | 320496M3 | A-320496M3 |
| AGCO | 623537M1 | A-623537M1 |
| AGCO | 1720205M3 | A-1720205M3 |
| AGCO | 1730782M1 | A-1730782M1 |
| AGCO | 629004M1 | A-629004M1 |
| AGCO | 826960M1 | A-826960M1 |
| AGCO | 1687610M91 | A-1687610M91 |
| AGCO | 962666M1 | A-962666M1 |
| AGCO | X696640500000 | A-X696640500000 |
| AGCO | 3619084M91 | A-3619084M91 |
| AGCO | 3779379M91 | A-3779379M91 |
| AGCO | 3780603M91 | A-3780603M91 |
| AGCO | 3780605M91 | A-3780605M91 |
| AGCO | 3780606M91 | A-3780606M91 |
| AGCO | 3780608M91 | A-3780608M91 |
| AGCO | 3780616M91 | A-3780616M91 |
| AGCO | 4274693M91 | A-4274693M91 |
| AGCO | 1447784M91 | A-1447784M91 |
| AGCO | 3381364M91 | A-3381364M91 |
| AGCO | 3786922M91 | A-3786922M91 |
| AGCO | 3808704M1 | A-3808704M1 |
| AGCO | 4274692M91 | A-4274692M91 |
| AGCO | 5015577M1 | A-5015577M1 |
| AGCO | 5016260M1 | A-5016260M1 |
| AGCO | 828729M1 | A-828729M1 |
| AGCO | D41990014 | A-D41990014 |
| AGCO | D41991100 | A-D41991100 |
| AGCO | Sm1718602 | A-SM1718602 |
| AGCO | V32889500 | A-V32889500 |
| AGCO | V33099800 | A-V33099800 |
| AGCO | V33279300 | A-V33279300 |
| AGCO | V33279600 | A-V33279600 |



AGCO

| OEM | OEM  Part No. | PIX  Part No. |
|------|--|--|
| AGCO | V33764400 | A-V33764400 |
| AGCO | V35380300 | A-V35380300 |
| AGCO | V35615000 | A-V35615000 |
| AGCO | V36763300 | A-V36763300 |
| AGCO | V684121275 | A-V684121275 |
| AGCO | V684121400 | A-V684121400 |
| AGCO | D41929100 | A-D41929100 |
| AGCO | 619317M2 | A-619317M2 |
| AGCO | D41983800 | A-D41983800 |
| AGCO | D41995700 | A-D41995700 |
| AGCO | D41980600 | A-D41980600 |
| AGCO | 412333M1 | A-412333M1 |
| AGCO | D41980000 | A-D41980000 |
| AGCO | D41980700 | A-D41980700 |
| AGCO | D41980100 | A-D41980100 |
| AGCO | D41994300 | A-D41994300 |
| AGCO | V685121370 | A-V685121370 |
| AGCO | V685121610 | A-V685121610 |
| AGCO | V685121905 | A-V685121905 |
| AGCO | 3789028M1 | A-3789028M1 |
| AGCO | 4271806M1 | A-4271806M1 |
| AGCO | 4273270M1 | A-4273270M1 |
| AGCO | 4275784M1 | A-4275784M1 |
| AGCO | 4282444M1 | A-4282444M1 |
| AGCO | V685061755 | A-V685061755 |
| AGCO | 506066D1 | A-506066D1 |
| AGCO | F716200040020 | A-F716200040020 |
| AGCO | V685081660 | A-V685081660 |
| AGCO | X696616800000 | A-X696616800000 |
| AGCO | 1688216M91 | A-1688216M91 |
| AGCO | 3371800M2 | A-3371800M2 |
| AGCO | 3637598M91 | A-3637598M91 |
| AGCO | 3648900M1 | A-3648900M1 |
| AGCO | 3777681M91 | A-3777681M91 |
| AGCO | 3780604M91 | A-3780604M91 |
| AGCO | 3787373M2 | A-3787373M2 |
| AGCO | 4272496M1 | A-4272496M1 |
| AGCO | 4273187M1 | A-4273187M1 |
| AGCO | 4273188M1 | A-4273188M1 |
| AGCO | 4274241M1 | A-4274241M1 |
| AGCO | 4275520M1 | A-4275520M1 |
| AGCO | 4276808M1 | A-4276808M1 |
| AGCO | 4278354M91 | A-4278354M91 |
| AGCO | X696623800000 | A-X696623800000 |
| AGCO | 684101050 | A-684101050 |
| AGCO | 684101225 | A-684101225 |
| AGCO | 684121200 | A-684121200 |



| OEM | OEM  Part No. | PIX  Part No. |
|------|--|--|
| AGCO | 684121275 | A-684121275 |
| AGCO | 684121375 | A-684121375 |
| AGCO | 684121400 | A-684121400 |
| AGCO | 685061675 | A-685061675 |
| AGCO | 685061725 | A-685061725 |
| AGCO | 685061755 | A-685061755 |
| AGCO | 685081660 | A-685081660 |
| AGCO | 685102194 | A-685102194 |
| AGCO | 685121370 | A-685121370 |
| AGCO | 685121530 | A-685121530 |
| AGCO | 685121610 | A-685121610 |
| AGCO | 685121765 | A-685121765 |
| AGCO | 685121905 | A-685121905 |
| AGCO | 685122140 | A-685122140 |
| AGCO | 685121585 | A-685121585 |
| AGCO | 783539M1 | A-783539M1 |
| AGCO | 072728T1 | A-072728T1 |
| AGCO | V684120918 | A-V684120918 |
| AGCO | 782835M1 | A-782835M1 |
| AGCO | 1616715M1 | A-1616715M1 |
| AGCO | 6907 | A-0006907 |
| AGCO | 621261M1 | A-621261M1 |
| AGCO | 905980M1 | A-905980M1 |
| AGCO | 619327M1 | A-619327M1 |
| AGCO | 6215259 | A-6215259 |
| AGCO | 55574 | A-0000055574 |
| AGCO | 311730870 | A-31-1730870 |
| AGCO | 412237M1 | A-412237M1 |
| AGCO | 1616714M1 | A-1616714M1 |
| AGCO | 401110M1 | A-401110M1 |
| AGCO | 621321M2 | A-621321M2 |
| AGCO | 41978300 | A-41978300 |
| AGCO | X696615002000 | A-X696615002000 |
| AGCO | X696615200000 | A-X696615200000 |
| AGCO | X696613501000 | A-X696613501000 |
| AGCO | X696615601000 | A-X696615601000 |
| AGCO | X696612200000 | A-X696612200000 |
| AGCO | X696612600000 | A-X696612600000 |
| AGCO | X696616201000 | A-X696616201000 |
| AGCO | X696612000000 | A-X696612000000 |
| AGCO | X696616702000 | A-X696616702000 |
| AGCO | X696614802000 | A-X696614802000 |
| AGCO | X696615704000 | A-X696615704000 |
| AGCO | X696616600000 | A-X696616600000 |
| AGCO | X696617800000 | A-X696617800000 |
| AGCO | X696623600000 | A-X696623600000 |
| AGCO | X696624300000 | A-X696624300000 |



AGCO

| OEM | OEM  Part No. | PIX  Part No. |
|------|--|--|
| AGCO | X696624200000 | A-X696624200000 |
| AGCO | X696624500000 | A-X696624500000 |
| AGCO | X696624800000 | A-X696624800000 |
| AGCO | X696642000000 | A-X696642000000 |
| AGCO | X696622700000 | A-X696622700000 |
| AGCO | X696623000000 | A-X696623000000 |
| AGCO | X696623200000 | A-X696623200000 |
| AGCO | 71324294 | A-71324294 |
| AGCO | 856591 | A-856591 |
| AGCO | H567947R2 | A-H567947R2 |
| AGCO | X697174000000 | A-X697174000000 |
| AGCO | 916201040200 | A-916201040200 |
| AGCO | 1976291 | A-1976291 |
| AGCO | D41986900 | A-D41986900 |
| AGCO | H558141R1 | A-H558141R1 |
| AGCO | 068918T1 | A-068918T1 |
| AGCO | X696989501000 | A-X696989501000 |
| AGCO | D419943400 | A-D419943400 |
| AGCO | 833874M2 | A-833874M2 |
| AGCO | 435127 | A-435127 |
| AGCO | 833865M2 | A-833865M2 |
| AGCO | 41990061 | A-41990061 |
| AGCO | V685081730 | A-V685081730 |
| AGCO | 524200040160 | A-524200040160 |
| AGCO | 511275M1 | A-511275M1 |
| AGCO | 433128 | A-433128 |
| AGCO | Cg350614260 | A-CG350614260 |
| AGCO | Cg350615010 | A-CG350615010 |
| AGCO | 340433166 | A-340433166 |
| AGCO | 3021251M1 | A-3021251M1 |
| AGCO | 523735M1 | A-523735M1 |
| AGCO | Cg350620010 | A-CG350620010 |
| AGCO | Cg350620100 | A-CG350620100 |
| AGCO | Sm1720402 | A-SM1720402 |
| AGCO | Cg350657000 | A-CG350657000 |
| AGCO | D41987000 | A-D41987000 |
| AGCO | 3808705M1 | A-3808705M1 |
| AGCO | F100002235531 | A-F100002235531 |
| AGCO | F100002235175 | A-F100002235175 |
| AGCO | 3809174M1 | A-3809174M1 |
| AGCO | 3809175M1 | A-3809175M1 |
| AGCO | 3815257M1 | A-3815257M1 |
| AGCO | 3817582M1 | A-3817582M1 |
| AGCO | 3815255M2 | A-3815255M2 |
| AGCO | 1851749M1 | A-1851749M1 |
| AGCO | V684121525 | A-V684121525 |
| AGCO | 3412285M2 | A-3412285M2 |



| OEM | OEM  Part No. | PIX  Part No. |
|------|--|--|
| AGCO | 3041017M1 | A-3041017M1 |
| AGCO | F117200010010 | A-F117200010010 |
| AGCO | V33764500 | A-V33764500 |
| AGCO | 321034M1 | A-321034M1 |
| AGCO | 402603M1 | A-402603M1 |
| AGCO | 916854M1 | A-916854M1 |
| AGCO | 405928M1 | A-405928M1 |
| AGCO | 233950M1 | A-233950M1 |
| AGCO | 903594M2 | A-903594M2 |
| AGCO | 1720674M2 | A-1720674M2 |
| AGCO | 340433257 | A-340433257 |
| AGCO | D41926400 | A-D41926400 |
| AGCO | 228999M1 | A-228999M1 |
| AGCO | 320593M2 | A-320593M2 |
| AGCO | D41955400 | A-D41955400 |
| AGCO | 3170531M1 | A-3170531M1 |
| AGCO | 3371438M1 | A-3371438M1 |
| AGCO | H143874C2 | A-H143874C2 |
| AGCO | Sm1721532 | A-SM1721532 |
| AGCO | Sm1719911 | A-SM1719911 |
| AGCO | Cg350614230 | A-CG350614230 |
| AGCO | Cg350620110 | A-CG350620110 |
| AGCO | Sm1719746 | A-SM1719746 |
| AGCO | 427806M1 | A-427806M1 |
| AGCO | 4277220M1 | A-4277220M1 |
| AGCO | 4273296M1 | A-4273296M1 |
| AGCO | 1603701M1 | A-1603701M1 |
| AGCO | 3098211M2 | A-3098211M2 |
| AGCO | 621262M1 | A-621262M1 |
| AGCO | 785810M1 | A-785810M1 |
| AGCO | 789853M1 | A-789853M1 |
| AGCO | 789930M1 | A-789930M1 |
| AGCO | 833858M5 | A-833858M5 |
| AGCO | 844077M1 | A-844077M1 |
| AGCO | 3617178M91 | A-3617178M91 |
| AGCO | 711148120 | A-711148120 |
| AGCO | 002215U1 | A-002215U1 |
| AGCO | E38713 | A-E38713 |
| AGCO | 3049010M91 | A-3049010M91 |
| AGCO | 228722M1 | A-228722M1 |
| AGCO | 411218M1 | A-411218M1 |
| AGCO | 905982M1 | A-905982M1 |
| AGCO | D41980900 | A-D41980900 |
| AGCO | 3373171M2 | A-3373171M2 |
| AGCO | V35354900 | A-V35354900 |
| AGCO | V33763300 | A-V33763300 |
| AGCO | 832538M1 | A-832538M1 |



AGCO

| OEM | OEM  Part No. | PIX  Part No. |
|------|--|--|
| AGCO | 623537M1 | A-623537M1 |
| AGCO | 1669923M1 | A-1669923M1 |
| AGCO | 1809095M2 | A-1809095M2 |
| AGCO | 832490M1 | A-832490M1 |
| AGCO | 71448482 | A-71448482 |
| AGCO | 513833M1 | A-513833M1 |
| AGCO | 513133M1 | A-513133M1 |
| AGCO | 3040949M1 | A-3040949M1 |
| AGCO | 529900M91 | A-529900M91 |
| AGCO | 71448442 | A-71448442 |
| AGCO | 500685D1 | A-500685D1 |
| AGCO | 410959M1 | A-410959M1 |
| AGCO | X696624100000 | A-X696624100000 |
| AGCO | 517344M2 | A-517344M2 |
| AGCO | 3787792M1 | A-3787792M1 |
| AGCO | 186976M1 | A-186976M1 |
| AGCO | 517456M1 | A-517456M1 |
| AGCO | 843198M1 | A-843198M1 |
| AGCO | 87583785 | A-87583785 |
| AGCO | 4275545M3 | A-4275545M3 |
| AGCO | 344311322 | A-344311322 |
| AGCO | X697173600000 | A-X697173600000 |
| AGCO | X696622900000 | A-X696622900000 |
| AGCO | X696623300000 | A-X696623300000 |
| AGCO | X696623400000 | A-X696623400000 |
| AGCO | 71382504 | A-71382504 |
| AGCO | 71140808 | A-71140808 |
| AGCO | 71135970 | A-71135970 |
| AGCO | 71141744 | A-71141744 |
| AGCO | 71170191 | A-71170191 |
| AGCO | 71125976 | A-71125976 |
| AGCO | 71134654 | A-71134654 |
| AGCO | 71139964 | A-71139964 |
| AGCO | 71125978 | A-71125978 |
| AGCO | 111954W1 | A-111954W1 |
| AGCO | 966427M1 | A-966427M1 |
| AGCO | 038355T1 | A-038355T1 |
| AGCO | 274339M91 | A-274339M91 |
| AGCO | 038357T1 | A-038357T1 |
| AGCO | 240447M3 | A-240447M3 |
| AGCO | 3590943M1 | A-3590943M1 |
| AGCO | 238887M2 | A-238887M2 |
| AGCO | 1483880M1 | A-1483880M1 |
| AGCO | 1483881M1 | A-1483881M1 |
| AGCO | 857219 | A-857219 |
| AGCO | 3316647M1 | A-3316647M1 |
| AGCO | 855007 | A-855007 |



| OEM | OEM  Part No. | PIX  Part No. |
|------|--|--|
| AGCO | 3175109M1 | A-3175109M1 |
| AGCO | 3175160M1 | A-3175160M1 |
| AGCO | 230356M4 | A-230356M4 |
| AGCO | 71146271 | A-71146271 |
| AGCO | 7855810 | A-7855810 |
| AGCO | 71380485 | A-71380485 |
| AGCO | 312449520 | A-31-2449520 |
| AGCO | 059105T1 | A-059105T1 |
| AGCO | 71348989 | A-71348989 |
| AGCO | 833856M1 | A-833856M1 |
| AGCO | 834061M1 | A-834061M1 |
| AGCO | 273837M91 | A-273837M91 |
| AGCO | 521110M1 | A-521110M1 |
| AGCO | 487802M2 | A-487802M2 |
| AGCO | 524413M92 | A-524413M92 |
| AGCO | 3815256M1 | A-3815256M1 |
| AGCO | 3145238M1 | A-3145238M1 |
| AGCO | 1612891M91 | A-1612891M91 |
| AGCO | 3612930M1 | A-3612930M1 |
| AGCO | 064441T1 | A-064441T1 |
| AGCO | 6200432M1 | A-6200432M1 |
| AGCO | 059106T1 | A-059106T1 |
| AGCO | 3226971M2 | A-3226971M2 |
| AGCO | 41982300 | A-41982300 |
| AGCO | X697171901000 | A-X697171901000 |
| AGCO | X697171900000 | A-X697171900000 |
| AGCO | X697172100000 | A-X697172100000 |
| AGCO | 344311121 | A-344311121 |
| AGCO | 344311124 | A-344311124 |
| AGCO | 344311131 | A-344311131 |
| AGCO | X697170100000 | A-X697170100000 |
| AGCO | 41990045 | A-41990045 |
| AGCO | 41990062 | A-41990062 |
| AGCO | 4276375M1 | A-4276375M1 |
| AGCO | 41990060 | A-41990060 |
| AGCO | 3810420M1 | A-3810420M1 |
| AGCO | 121282 | A-121282 |
| AGCO | 124976 | A-124976 |
| AGCO | 122297 | A-122297 |
| AGCO | 122299 | A-122299 |
| AGCO | 122649 | A-122649 |
| AGCO | 122651 | A-122651 |
| AGCO | 122652 | A-122652 |
| AGCO | 122764 | A-122764 |
| AGCO | 122076 | A-122076 |
| AGCO | X696.614.700.000 | A-X696.614.700.000 |
| AGCO | 1630361M1 | A-1630361M1 |



AGCO

| OEM | OEM  Part No. | PIX  Part No. |
|------|--|--|
| AGCO | X696.615.408.000 | A-X696.615.408.000 |
| AGCO | X696.615.600.000 | A-X696.615.600.000 |
| AGCO | X696.610.600.000 | A-X696.610.600.000 |
| AGCO | X696.612.313.000 | A-X696.612.313.000 |
| AGCO | X696.612.500.000 | A-X696.612.500.000 |
| AGCO | X696.611.312.000 | A-X696.611.312.000 |
| AGCO | X696.613.308.000 | A-X696.613.308.000 |
| AGCO | X696.613.600.000 | A-X696.613.600.000 |
| AGCO | 41900000 | A-41900000 |
| AGCO | 624728M1 | A-624728M1 |
| AGCO | 1700120M1 | A-1700120M1 |
| AGCO | X696.619.413.000 | A-X696.619.413.000 |
| AGCO | 1876670M1 | A-1876670M1 |
| AGCO | 906424M1 | A-906424M1 |
| AGCO | 1614629M91 | A-1614629M91 |
| AGCO | 1730034M91 | A-1730034M91 |
| AGCO | 1730033M91 | A-1730033M91 |
| AGCO | X696.618.200.000 | A-X696.618.200.000 |
| AGCO | 511277M3 | A-511277M3 |
| AGCO | 41904900 | A-41904900 |
| AGCO | 41905600 | A-41905600 |
| AGCO | 117029010800 | A-117029010800 |
| AGCO | 3538921M1 | A-3538921M1 |
| AGCO | 84416M1 | A-84416M1 |
| AGCO | 41907500 | A-41907500 |
| AGCO | 3021313M3 | A-3021313M3 |
| AGCO | 41907800 | A-41907800 |
| AGCO | 1718508M91 | A-1718508M91 |
| AGCO | 3021192M1 | A-3021192M1 |
| AGCO | 530756M1 | A-530756M1 |
| AGCO | 41916800 | A-41916800 |
| AGCO | X696.622.000.000 | A-X696.622.000.000 |
| AGCO | 41902600 | A-41902600 |
| AGCO | 340433109 | A-340433109 |
| AGCO | 1617332M1 | A-1617332M1 |
| AGCO | X696.519.400.000 | A-X696.519.400.000 |
| AGCO | 41903000 | A-41903000 |
| AGCO | 41903400 | A-41903400 |
| AGCO | 514806M1 | A-514806M1 |
| AGCO | 340433119 | A-340433119 |
| AGCO | 523733M1 | A-523733M1 |
| AGCO | 530669M1 | A-530669M1 |
| AGCO | 058147P1 | A-058147P1 |
| AGCO | 518125M2 | A-518125M2 |
| AGCO | 669452M91 | A-669452M91 |
| AGCO | 41962600 | A-41962600 |
| AGCO | 1810382M91 | A-1810382M91 |



| OEM | OEM  Part No. | PIX  Part No. |
|------|--|--|
| AGCO | 605638M91 | A-605638M91 |
| AGCO | 1810543M91 | A-1810543M91 |
| AGCO | 403041M1 | A-403041M1 |
| AGCO | X696.633.800.000 | A-X696.633.800.000 |
| AGCO | 340433238 | A-340433238 |
| AGCO | 402604M1 | A-402604M1 |
| AGCO | 41924700 | A-41924700 |
| AGCO | 41925200 | A-41925200 |
| AGCO | 340433240 | A-340433240 |
| AGCO | 340433242 | A-340433242 |
| AGCO | 41924900 | A-41924900 |
| AGCO | 324872M1 | A-324872M1 |
| AGCO | X696.635.500.000 | A-X696.635.500.000 |
| AGCO | 417468M1 | A-417468M1 |
| AGCO | 584850M1 | A-584850M1 |
| AGCO | 604964M1 | A-604964M1 |
| AGCO | 41926100 | A-41926100 |
| AGCO | 340433251 | A-340433251 |
| AGCO | 7855356 | A-0007855356 |
| AGCO | 41926300 | A-41926300 |
| AGCO | 412074M1 | A-412074M1 |
| AGCO | 855650 | A-855650 |
| AGCO | 41926500 | A-41926500 |
| AGCO | 41926600 | A-41926600 |
| AGCO | 41964500 | A-41964500 |
| AGCO | 41964400 | A-41964400 |
| AGCO | 26733247 | A-26733247 |
| AGCO | 41963800 | A-41963800 |
| AGCO | 320596M1 | A-320596M1 |
| AGCO | 41928400 | A-41928400 |
| AGCO | 41928100 | A-41928100 |
| AGCO | 6273869M1 | A-6273869M1 |
| AGCO | 41929400 | A-41929400 |
| AGCO | 41930300 | A-41930300 |
| AGCO | 41930600 | A-41930600 |
| AGCO | 402605M1 | A-402605M1 |
| AGCO | 26733596 | A-26733596 |
| AGCO | 3101337M1 | A-3101337M1 |
| AGCO | 41965100 | A-41965100 |
| AGCO | 403071M1 | A-403071M1 |
| AGCO | 41931600 | A-41931600 |
| AGCO | 526370 | A-526370 |
| AGCO | 41931100 | A-41931100 |
| AGCO | 41932600 | A-41932600 |
| AGCO | 41932800 | A-41932800 |
| AGCO | 320623M2 | A-320623M2 |
| AGCO | 41933400 | A-41933400 |



AGCO

| OEM | OEM  Part No. | PIX  Part No. |
|------|--|--|
| AGCO | 41933900 | A-41933900 |
| AGCO | 26733578 | A-26733578 |
| AGCO | 761757 | A-761757 |
| AGCO | 527976 | A-527976 |
| AGCO | 41966500 | A-41966500 |
| AGCO | 41934900 | A-41934900 |
| AGCO | 41936300 | A-41936300 |
| AGCO | 41935500 | A-41935500 |
| AGCO | 41935700 | A-41935700 |
| AGCO | 832882M1 | A-832882M1 |
| AGCO | 41966900 | A-41966900 |
| AGCO | 26733588 | A-26733588 |
| AGCO | 407692M1 | A-407692M1 |
| AGCO | 41937600 | A-41937600 |
| AGCO | 6211078M1 | A-6211078M1 |
| AGCO | 41936800 | A-41936800 |
| AGCO | 41936500 | A-41936500 |
| AGCO | 41937800 | A-41937800 |
| AGCO | 41937300 | A-41937300 |
| AGCO | 26733248 | A-26733248 |
| AGCO | 3371692M1 | A-3371692M1 |
| AGCO | 41938000 | A-41938000 |
| AGCO | 6209375M1 | A-6209375M1 |
| AGCO | 41941900 | A-41941900 |
| AGCO | 41938900 | A-41938900 |
| AGCO | 41939300 | A-41939300 |
| AGCO | 41940900 | A-41940900 |
| AGCO | 41941100 | A-41941100 |
| AGCO | 3465729M1 | A-3465729M1 |
| AGCO | 41943600 | A-41943600 |
| AGCO | 1715558M91 | A-1715558M91 |
| AGCO | 41922200 | A-41922200 |
| AGCO | 623098M1 | A-623098M1 |
| AGCO | 1641945M1 | A-1641945M1 |
| AGCO | 641696M1 | A-641696M1 |
| AGCO | 41962000 | A-41962000 |
| AGCO | 636208M1 | A-636208M1 |
| AGCO | 636276M1 | A-636276M1 |
| AGCO | 328656M1 | A-328656M1 |
| AGCO | 1810378M91 | A-1810378M91 |
| AGCO | 619595M1 | A-619595M1 |
| AGCO | 782850M2 | A-782850M2 |
| AGCO | 322768M1 | A-322768M1 |
| AGCO | 320595M2 | A-320595M2 |
| AGCO | 41995100 | A-41995100 |
| AGCO | 418192M1 | A-418192M1 |
| AGCO | 41951700 | A-41951700 |

| OEM | OEM  Part No. | PIX  Part No. |
|------|--|--|
| AGCO | 410958M1 | A-410958M1 |
| AGCO | 410957M1 | A-410957M1 |
| AGCO | 604735M1 | A-604735M1 |
| AGCO | 412399M1 | A-412399M1 |
| AGCO | 6239971M1 | A-6239971M1 |
| AGCO | 6210650M1 | A-6210650M1 |
| AGCO | 3049776M1 | A-3049776M1 |
| AGCO | 41981900 | A-41981900 |
| AGCO | 901855M1 | A-901855M1 |
| AGCO | 56325 | A-56325 |
| AGCO | 340433476 | A-340433476 |
| AGCO | 916799M1 | A-916799M1 |
| AGCO | 6203660M1 | A-6203660M1 |
| AGCO | 1722835M1 | A-1722835M1 |
| AGCO | 201108520 | A-201108520 |
| AGCO | 6200242M1 | A-6200242M1 |
| AGCO | 41953700 | A-41953700 |
| AGCO | 41953300 | A-41953300 |
| AGCO | 41987100 | A-41987100 |
| AGCO | 41983300 | A-41983300 |
| AGCO | 41982000 | A-41982000 |
| AGCO | 41950000 | A-41950000 |
| AGCO | 856641 | A-856641 |
| AGCO | 787237M1 | A-787237M1 |
| AGCO | 195672M1 | A-195672M1 |
| AGCO | 200432M1 | A-200432M1 |
| AGCO | 41983900 | A-41983900 |
| AGCO | 402606M1 | A-402606M1 |
| AGCO | 784789M2 | A-784789M2 |
| AGCO | 41954100 | A-41954100 |
| AGCO | 856401 | A-856401 |
| AGCO | 41985900 | A-41985900 |
| AGCO | 7855331 | A-7855331 |
| AGCO | 3050742M1 | A-3050742M1 |
| AGCO | 053928T1 | A-053928T1 |
| AGCO | 41957600 | A-41957600 |
| AGCO | 410919M1 | A-410919M1 |
| AGCO | 41954300 | A-41954300 |
| AGCO | 412236M1 | A-412236M1 |
| AGCO | 41982600 | A-41982600 |
| AGCO | 41957500 | A-41957500 |
| AGCO | 1720488M1 | A-1720488M1 |
| AGCO | 1483884M1 | A-1483884M1 |
| AGCO | 432433 | A-432433 |
| AGCO | 41954800 | A-41954800 |
| AGCO | 41986800 | A-41986800 |
| AGCO | 41985700 | A-41985700 |

AGCO

| OEM | OEM  Part No. | PIX  Part No. |
|------|--|--|
| AGCO | 41950200 | A-41950200 |
| AGCO | 700714423 | A-700714423 |
| AGCO | 6212790M1 | A-6212790M1 |
| AGCO | 41955900 | A-41955900 |
| AGCO | 41957800 | A-41957800 |
| AGCO | 1731015M1 | A-1731015M1 |
| AGCO | 41955500 | A-41955500 |
| AGCO | 41950300 | A-41950300 |
| AGCO | 6203678M1 | A-6203678M1 |
| AGCO | 41984900 | A-41984900 |
| AGCO | 1731023M1 | A-1731023M1 |
| AGCO | 41955400 | A-41955400 |
| AGCO | 6211250M1 | A-6211250M1 |
| AGCO | 6216726M1 | A-6216726M1 |
| AGCO | 433442 | A-433442 |
| AGCO | 41955800 | A-41955800 |
| AGCO | 1615962M1 | A-1615962M1 |
| AGCO | 28284841 | A-28284841 |
| AGCO | 916800M2 | A-916800M2 |
| AGCO | 41956500 | A-41956500 |
| AGCO | 1628951M1 | A-1628951M1 |
| AGCO | 1730687M1 | A-1730687M1 |
| AGCO | 26732833 | A-26732833 |
| AGCO | 843324M1 | A-843324M1 |
| AGCO | 41986500 | A-41986500 |
| AGCO | 41983200 | A-41983200 |
| AGCO | 1730781M1 | A-1730781M1 |
| AGCO | 855791 | A-855791 |
| AGCO | 3173304M1 | A-3173304M1 |
| AGCO | 3172001M1 | A-3172001M1 |
| AGCO | 406681M1 | A-406681M1 |
| AGCO | 41985400 | A-41985400 |
| AGCO | 1730976M1 | A-1730976M1 |
| AGCO | 41987600 | A-41987600 |
| AGCO | 41958500 | A-41958500 |
| AGCO | 41958600 | A-41958600 |
| AGCO | 41987400 | A-41987400 |
| AGCO | 406562M1 | A-406562M1 |
| AGCO | 1730366M1 | A-1730366M1 |
| AGCO | 41987500 | A-41987500 |
| AGCO | 417972M1 | A-417972M1 |
| AGCO | 41984300 | A-41984300 |
| AGCO | 41988900 | A-41988900 |
| AGCO | 41988600 | A-41988600 |
| AGCO | 41988700 | A-41988700 |
| AGCO | 41989800 | A-41989800 |
| AGCO | 41989000 | A-41989000 |

| OEM | OEM  Part No. | PIX  Part No. |
|------|--|--|
| AGCO | 41992700 | A-41992700 |
| AGCO | 41990037 | A-41990037 |
| AGCO | 41989100 | A-41989100 |
| AGCO | 41992400 | A-41992400 |
| AGCO | 41998900 | A-41998900 |
| AGCO | Ag516559 | A-AG516559 |
| AGCO | Ag516861 | A-AG516861 |
| AGCO | Ag516558 | A-AG516558 |
| AGCO | Ag517279 | A-AG517279 |
| AGCO | 233213M1 | A-233213M1 |
| AGCO | Gr17880810 | A-GR17880810 |
| AGCO | 290331 | A-290331 |
| AGCO | 3035569M1 | A-3035569M1 |
| AGCO | 3035568M2 | A-3035568M2 |
| AGCO | X697.170.100.000 | A-X697.170.100.000 |
| AGCO | 46488200 | A-46488200 |
| AGCO | X697.171.900.000 | A-X697.171.900.000 |
| AGCO | X697.171.901.000 | A-X697.171.901.000 |
| AGCO | X697.172.100.000 | A-X697.172.100.000 |
| AGCO | 41991400 | A-41991400 |
| AGCO | 063211T1 | A-063211T1 |
| AGCO | 765173 | A-765173 |
| AGCO | 218560M91 | A-218560M91 |
| AGCO | 765174 | A-765174 |
| AGCO | 039631T1 | A-039631T1 |
| AGCO | 6211081M1 | A-6211081M1 |
| AGCO | 7855349 | A-7855349 |
| AGCO | 6203764M1 | A-6203764M1 |
| AGCO | 41992300 | A-41992300 |
| AGCO | 065188T1 | A-065188T1 |
| AGCO | 063212T1 | A-063212T1 |
| AGCO | 41992000 | A-41992000 |
| AGCO | 41978100 | A-41978100 |
| AGCO | 068154T1 | A-068154T1 |
| AGCO | 6210826M1 | A-6210826M1 |
| AGCO | 26735939 | A-26735939 |
| AGCO | 6209374M1 | A-6209374M1 |
| AGCO | 41992100 | A-41992100 |
| AGCO | 41992200 | A-41992200 |
| AGCO | 6203462M2 | A-6203462M2 |
| AGCO | 41977800 | A-41977800 |
| AGCO | 41977700 | A-41977700 |
| AGCO | 41990049 | A-41990049 |
| AGCO | 41990047 | A-41990047 |
| AGCO | 6210914M1 | A-6210914M1 |
| AGCO | 41990048 | A-41990048 |
| AGCO | 41977600 | A-41977600 |

AGCO



| OEM | OEM  Part No. | PIX  Part No. | OEM | OEM  Part No. | PIX  Part No. |
|------|--|--|------|--|--|
| AGCO | 41977900 | A-41977900 | AGCO | 41990059 | A-41990059 |
| AGCO | 41978700 | A-41978700 | AGCO | 41990064 | A-41990064 |
| AGCO | 3370141M1 | A-3370141M1 | AGCO | 41978000 | A-41978000 |
| AGCO | 26732820 | A-26732820 | AGCO | 700708547 | A-700708547 |
| AGCO | 6201516M1 | A-6201516M1 | AGCO | 700715554 | A-700715554 |
| AGCO | 6211072M1 | A-6211072M1 | AGCO | 685081785 | A-685081785 |
| AGCO | 6219167M1 | A-6219167M1 | AGCO | X696.614.802.000 | A-X696.614.802.000 |
| AGCO | 6212014M1 | A-6212014M1 | AGCO | 3383045M1 | A-3383045M1 |
| AGCO | 6211508M1 | A-6211508M1 | AGCO | 3619357M1 | A-3619357M1 |
| AGCO | 320551M1 | A-320551M1 | AGCO | 3700658M91 | A-3700658M91 |
| AGCO | 856112 | A-856112 | AGCO | 3761507M91 | A-3761507M91 |
| AGCO | 28274029 | A-28274029 | AGCO | X696.611.611.000 | A-X696.611.611.000 |
| AGCO | 270412 | A-270412 | AGCO | X696.612.000.000 | A-X696.612.000.000 |
| AGCO | 41990054 | A-41990054 | AGCO | X696.612.200.000 | A-X696.612.200.000 |
| AGCO | 6202555M1 | A-6202555M1 | AGCO | X696.612.400.000 | A-X696.612.400.000 |
| AGCO | 41990063 | A-41990063 | AGCO | X696.612.600.000 | A-X696.612.600.000 |
| AGCO | 41990055 | A-41990055 | AGCO | X696.612.602.000 | A-X696.612.602.000 |
| AGCO | 270791 | A-270791 | AGCO | X696.612.811.000 | A-X696.612.811.000 |
| AGCO | 41995600 | A-41995600 | AGCO | X696.612.913.000 | A-X696.612.913.000 |
| AGCO | 856047 | A-856047 | AGCO | X696.613.101.000 | A-X696.613.101.000 |
| AGCO | 71390209 | A-71390209 | AGCO | X696.613.501.000 | A-X696.613.501.000 |
| AGCO | 41994600 | A-41994600 | AGCO | X696.613.801.000 | A-X696.613.801.000 |
| AGCO | 71385693 | A-71385693 | AGCO | X696.613.901.000 | A-X696.613.901.000 |
| AGCO | 71387775 | A-71387775 | AGCO | X696.614.513.000 | A-X696.614.513.000 |
| AGCO | 41990053 | A-41990053 | AGCO | X696.614.601.000 | A-X696.614.601.000 |
| AGCO | 71399562 | A-71399562 | AGCO | X696.614.913.000 | A-X696.614.913.000 |
| AGCO | 41991600 | A-41991600 | AGCO | X696.615.002.000 | A-X696.615.002.000 |
| AGCO | 3036551M1 | A-3036551M1 | AGCO | X696.615.200.000 | A-X696.615.200.000 |
| AGCO | 344311320 | A-344311320 | AGCO | X696.615.301.000 | A-X696.615.301.000 |
| AGCO | 26732815 | A-26732815 | AGCO | X696.615.401.000 | A-X696.615.401.000 |
| AGCO | 6211083M1 | A-6211083M1 | AGCO | X696.615.601.000 | A-X696.615.601.000 |
| AGCO | 912877M1 | A-912877M1 | AGCO | X696.615.704.000 | A-X696.615.704.000 |
| AGCO | 843810M1 | A-843810M1 | AGCO | X696.616.000.000 | A-X696.616.000.000 |
| AGCO | 41990058 | A-41990058 | AGCO | X696.616.102.000 | A-X696.616.102.000 |
| AGCO | 41990056 | A-41990056 | AGCO | X696.616.201.000 | A-X696.616.201.000 |
| AGCO | 41990057 | A-41990057 | AGCO | X696.616.300.000 | A-X696.616.300.000 |
| AGCO | 41993800 | A-41993800 | AGCO | X696.616.600.000 | A-X696.616.600.000 |
| AGCO | 526155 | A-526155 | AGCO | X696.616.702.000 | A-X696.616.702.000 |
| AGCO | 527975 | A-527975 | AGCO | X696.616.800.000 | A-X696.616.800.000 |
| AGCO | 6211082M1 | A-6211082M1 | AGCO | X696.616.913.000 | A-X696.616.913.000 |
| AGCO | 41990065 | A-41990065 | AGCO | X696.617.800.000 | A-X696.617.800.000 |
| AGCO | 41994500 | A-41994500 | AGCO | X696.617.900.000 | A-X696.617.900.000 |
| AGCO | 105654W1 | A-105654W1 | AGCO | 1686615M91 | A-1686615M91 |
| AGCO | 6202933M1 | A-6202933M1 | AGCO | X696.617.701.000 | A-X696.617.701.000 |
| AGCO | 6211079M1 | A-6211079M1 | AGCO | 3581635M1 | A-3581635M1 |
| AGCO | X697.173.600.000 | A-X697.173.600.000 | AGCO | 3780908M91 | A-3780908M91 |
| AGCO | 26733312 | A-26733312 | AGCO | 5115483M1 | A-5115483M1 |

AGCO

| OEM | OEM  Part No. | PIX  Part No. |
|------|--|--|
| AGCO | 6216981M1 | A-6216981M1 |
| AGCO | X696.619.200.000 | A-X696.619.200.000 |
| AGCO | X696.622.700.000 | A-X696.622.700.000 |
| AGCO | X696.622.800.000 | A-X696.622.800.000 |
| AGCO | X696.622.900.000 | A-X696.622.900.000 |
| AGCO | X696.623.000.000 | A-X696.623.000.000 |
| AGCO | X696.623.200.000 | A-X696.623.200.000 |
| AGCO | X696.623.300.000 | A-X696.623.300.000 |
| AGCO | X696.623.400.000 | A-X696.623.400.000 |
| AGCO | X696.623.600.000 | A-X696.623.600.000 |
| AGCO | X696.623.700.000 | A-X696.623.700.000 |
| AGCO | X696.623.800.000 | A-X696.623.800.000 |
| AGCO | X696.623.900.000 | A-X696.623.900.000 |
| AGCO | X696.624.100.000 | A-X696.624.100.000 |
| AGCO | X696.624.200.000 | A-X696.624.200.000 |
| AGCO | X696.624.300.000 | A-X696.624.300.000 |
| AGCO | X696.624.400.000 | A-X696.624.400.000 |
| AGCO | X696.624.500.000 | A-X696.624.500.000 |
| AGCO | X696.624.800.000 | A-X696.624.800.000 |
| AGCO | X696.642.000.000 | A-X696.642.000.000 |
| AGCO | 049880T1 | A-049880T1 |
| AGCO | 3777748M2 | A-3777748M2 |
| AGCO | 3808730M1 | A-3808730M1 |
| AGCO | 1614371M1 | A-1614371M1 |
| AGCO | 3386190M91 | A-3386190M91 |
| AGCO | 3595070M91 | A-3595070M91 |
| AGCO | 3614715M2 | A-3614715M2 |
| AGCO | 3780061M91 | A-3780061M91 |
| AGCO | 521370M1 | A-521370M1 |
| AGCO | 3614715M1 | A-3614715M1 |
| AGCO | Wr10487 | A-WR10487 |
| AGCO | 41972100 | A-41972100 |
| AGCO | 41972200 | A-41972200 |
| AGCO | 41972300 | A-41972300 |
| AGCO | 583824M1 | A-583824M1 |
| AGCO | 41972800 | A-41972800 |
| AGCO | 41973000 | A-41973000 |
| AGCO | 41974300 | A-41974300 |
| AGCO | 41976200 | A-41976200 |
| AGCO | 3404339850 | A-3404339850 |
| AGCO | 3404339860 | A-3404339860 |
| AGCO | 41978500 | A-41978500 |
| AGCO | 41989900 | A-41989900 |
| AGCO | 969186M1 | A-969186M1 |
| AGCO | 3372217M1 | A-3372217M1 |
| AGCO | 3036278M1 | A-3036278M1 |
| AGCO | 45055100 | A-45055100 |



| OEM | OEM  Part No. | PIX  Part No. |
|------|--|--|
| AGCO | 960972M1 | A-960972M1 |
| AGCO | 49906200 | A-49906200 |
| AGCO | 1604464M1 | A-1604464M1 |
| AGCO | 3106033M1 | A-3106033M1 |
| AGCO | 41995000 | A-41995000 |
| AGCO | 407189M91 | A-407189M91 |
| AGCO | 41996400 | A-41996400 |
| AGCO | 41996100 | A-41996100 |
| AGCO | 121745 | A-121745 |
| AGCO | 531316M1 | A-531316M1 |
| AGCO | 1721710M1 | A-1721710M1 |
| AGCO | 122129 | A-122129 |
| AGCO | 41990007 | A-41990007 |
| AGCO | 41997200 | A-41997200 |
| AGCO | 41996500 | A-41996500 |
| AGCO | 122968 | A-122968 |
| AGCO | 123027 | A-123027 |
| AGCO | 41997500 | A-41997500 |
| AGCO | 26732797 | A-26732797 |
| AGCO | 41997600 | A-41997600 |
| AGCO | 41996300 | A-41996300 |
| AGCO | 41999800 | A-41999800 |
| AGCO | 41999700 | A-41999700 |
| AGCO | 407218M1 | A-407218M1 |
| AGCO | 1621182M1 | A-1621182M1 |
| AGCO | 3193693M2 | A-3193693M2 |
| AGCO | 46301055 | A-46301055 |
| AGCO | 410195M1 | A-410195M1 |
| AGCO | X696.640.500.000 | A-X696.640.500.000 |
| AGCO | X696.640.600.000 | A-X696.640.600.000 |
| AGCO | 3920712M | A-3920712M |
| AGCO | 3042011M1 | A-3042011M1 |
| AGCO | 3042012M1 | A-3042012M1 |
| AGCO | 201108473 | A-201108473 |
| AGCO | 3043154M1 | A-3043154M1 |
| AGCO | 3043153M1 | A-3043153M1 |
| AGCO | 41995700 | A-41995700 |
| AGCO | 41981400 | A-41981400 |
| AGCO | 41980300 | A-41980300 |
| AGCO | 703899 | A-703899 |
| AGCO | 340435126 | A-340435126 |
| AGCO | 71170490 | A-71170490 |
| AGCO | 833857M3 | A-833857M3 |
| AGCO | 621320M2 | A-621320M2 |
| AGCO | 71197876 | A-71197876 |
| AGCO | 41980800 | A-41980800 |
| AGCO | 053640T1 | A-053640T1 |



AGCO

| OEM | OEM  Part No. | PIX  Part No. |
|------|--|--|
| AGCO | 41981500 | A-41981500 |
| AGCO | 41990014 | A-41990014 |
| AGCO | 41990022 | A-41990022 |
| AGCO | 41990021 | A-41990021 |
| AGCO | 3920203M | A-3920203M |
| AGCO | 41999100 | A-41999100 |
| AGCO | 3656765M1 | A-3656765M1 |
| AGCO | 41991100 | A-41991100 |
| AGCO | 122253 | A-122253 |
| AGCO | 41990019 | A-41990019 |
| AGCO | 41990026 | A-41990026 |
| AGCO | 41990011 | A-41990011 |
| AGCO | 41990020 | A-41990020 |
| AGCO | 41990012 | A-41990012 |
| AGCO | 3700656M1 | A-3700656M1 |
| AGCO | 41921700 | A-41921700 |
| AGCO | 122075 | A-122075 |
| AGCO | X696615401000 | A-X696615401000 |
| AGCO | X697.174.000.000 | A-X697.174.000.000 |
| AGCO | X696619413000 | A-X696619413000 |
| AGCO | X696618200000 | A-X696618200000 |
| AGCO | 685121555 | A-685121555 |
| AGCO | V685121555 | A-V685121555 |
| AGCO | 685121570 | A-685121570 |
| AGCO | 685121725 | A-685121725 |
| AGCO | V685121725 | A-V685121725 |
| AGCO | 685121845 | A-685121845 |
| AGCO | V685121845 | A-V685121845 |
| AGCO | 685121860 | A-685121860 |
| AGCO | 685121880 | A-685121880 |
| AGCO | V685121860 | A-V685121860 |
| AGCO | 685121945 | A-685121945 |
| AGCO | V685121945 | A-V685121945 |
| AGCO | 685121965 | A-685121965 |
| AGCO | V685121965 | A-V685121965 |
| AGCO | 685122020 | A-685122020 |
| AGCO | V685122020 | A-V685122020 |
| AGCO | 4293007M2 | A-4293007M2 |
| AGCO | 6290138M1 | A-6290138M1 |
| AGCO | 340433141 | A-340433141 |
| AGCO | 700719689 | A-700719689 |
| AGCO | 41910400 | A-41910400 |
| AGCO | D41910400 | A-D41910400 |
| AGCO | 340433195 | A-340433195 |
| AGCO | X696622000000 | A-X696622000000 |
| AGCO | X696519400000 | A-X696519400000 |
| AGCO | 685141585 | A-685141585 |



| OEM | OEM  Part No. | PIX  Part No. |
|------|--|--|
| AGCO | V685141585 | A-V685141585 |
| AGCO | 3315897M1 | A-3315897M1 |
| AGCO | 836007765 | A-836007765 |
| AGCO | V836007765 | A-V836007765 |
| AGCO | X696633800000 | A-X696633800000 |
| AGCO | 6263504M1 | A-6263504M1 |
| AGCO | X696635500000 | A-X696635500000 |
| AGCO | 3590944M1 | A-3590944M1 |
| AGCO | 340433280 | A-340433280 |
| AGCO | 402177M1 | A-402177M1 |
| AGCO | 340344276 | A-340344276 |
| AGCO | 26746958 | A-26746958 |
| AGCO | D41932800 | A-D41932800 |
| AGCO | 6247232M1 | A-6247232M1 |
| AGCO | 6247231M1 | A-6247231M1 |
| AGCO | 26746968 | A-26746968 |
| AGCO | 321034M3 | A-321034M3 |
| AGCO | 6230964M1 | A-6230964M1 |
| AGCO | 26746970 | A-26746970 |
| AGCO | 6248667M1 | A-6248667M1 |
| AGCO | 41944700 | A-41944700 |
| AGCO | D41944700 | A-D41944700 |
| AGCO | 26746971 | A-26746971 |
| AGCO | X696.629.509.000 | A-X696.629.509.000 |
| AGCO | X696629509000 | A-X696629509000 |
| AGCO | 600P02 | A-600P02 |
| AGCO | 411020M1 | A-411020M1 |
| AGCO | 1604055M2 | A-1604055M2 |
| AGCO | 418209M1 | A-418209M1 |
| AGCO | 6220987M1 | A-6220987M1 |
| AGCO | 112366410100 | A-112366410100 |
| AGCO | 6284282M1 | A-6284282M1 |
| AGCO | 063971T2 | A-063971T2 |
| AGCO | 6231843M1 | A-6231843M1 |
| AGCO | 1731014M1 | A-1731014M1 |
| AGCO | 87041732C | A-87041732C |
| AGCO | 340433477 | A-340433477 |
| AGCO | 6217977M1 | A-6217977M1 |
| AGCO | 6230739M1 | A-6230739M1 |
| AGCO | 048392T1 | A-048392T1 |
| AGCO | D41957800 | A-D41957800 |
| AGCO | Xp12472 | A-XP12472 |
| AGCO | 71447314 | A-71447314 |
| AGCO | 26746972 | A-26746972 |
| AGCO | 1730367M1 | A-1730367M1 |
| AGCO | 6248670M1 | A-6248670M1 |
| AGCO | 6266289M1 | A-6266289M1 |

AGCO

| OEM | OEM  Part No. | PIX  Part No. |
|------|--|--|
| AGCO | 6268912M1 | A-6268912M1 |
| AGCO | 6237301M1 | A-6237301M1 |
| AGCO | 28263120 | A-28263120 |
| AGCO | 6220817M1 | A-6220817M1 |
| AGCO | 6213293M1 | A-6213293M1 |
| AGCO | 6213293M2 | A-6213293M2 |
| AGCO | 6248653M1 | A-6248653M1 |
| AGCO | 6235815M1 | A-6235815M1 |
| AGCO | 6248647M1 | A-6248647M1 |
| AGCO | 6235825M1 | A-6235825M1 |
| AGCO | 6248658M1 | A-6248658M1 |
| AGCO | 344311171 | A-344311171 |
| AGCO | 6298767M1 | A-6298767M1 |
| AGCO | 6232489M1 | A-6232489M1 |
| AGCO | 6230741M1 | A-6230741M1 |
| AGCO | 6289543M1 | A-6289543M1 |
| AGCO | 6298761M1 | A-6298761M1 |
| AGCO | 344311278 | A-344311278 |
| AGCO | 34431128 | A-34431128 |
| AGCO | 6290856M1 | A-6290856M1 |
| AGCO | 71442230 | A-71442230 |
| AGCO | 71440999 | A-71440999 |
| AGCO | 6289544M1 | A-6289544M1 |
| AGCO | 6303174M1 | A-6303174M1 |
| AGCO | 71442255 | A-71442255 |
| AGCO | 344311132 | A-344311132 |
| AGCO | 6231546M1 | A-6231546M1 |
| AGCO | 71448503 | A-71448503 |
| AGCO | 6289545M1 | A-6289545M1 |
| AGCO | 6268436M1 | A-6268436M1 |
| AGCO | 700719205 | A-700719205 |
| AGCO | 71462784 | A-71462784 |
| AGCO | 6294242M1 | A-6294242M1 |
| AGCO | 71462787 | A-71462787 |
| AGCO | 71447401 | A-71447401 |
| AGCO | 71449576 | A-71449576 |
| AGCO | 6154998 | A-6154998 |
| AGCO | 6231547M1 | A-6231547M1 |
| AGCO | 344312129 | A-344312129 |
| AGCO | 6159053 | A-6159053 |
| AGCO | 71448508 | A-71448508 |
| AGCO | 6153715 | A-6153715 |
| AGCO | 26746997 | A-26746997 |
| AGCO | 26746996 | A-26746996 |
| AGCO | X696.989.501.000 | A-X696.989.501.000 |
| AGCO | 71441902 | A-71441902 |
| AGCO | 6227303M1 | A-6227303M1 |

| OEM | OEM  Part No. | PIX  Part No. |
|------|--|--|
| AGCO | 71440993 | A-71440993 |
| AGCO | 6220518M1 | A-6220518M1 |
| AGCO | 6237294M1 | A-6237294M1 |
| AGCO | 28263240 | A-28263240 |
| AGCO | 344311238 | A-344311238 |
| AGCO | 344311240 | A-344311240 |
| AGCO | 344311233 | A-344311233 |
| AGCO | 344311237 | A-344311237 |
| AGCO | 344411229 | A-344411229 |
| AGCO | 6303185M1 | A-6303185M1 |
| AGCO | 26746995 | A-26746995 |
| AGCO | 1141641 | A-1141641 |
| AGCO | 344311235 | A-344311235 |
| AGCO | 344311232 | A-344311232 |
| AGCO | 3443112320 | A-3443112320 |
| AGCO | 71441879 | A-71441879 |
| AGCO | 344311231 | A-344311231 |
| AGCO | 3443112310 | A-3443112310 |
| AGCO | 344311229 | A-344311229 |
| AGCO | 344311236 | A-344311236 |
| AGCO | 344311234 | A-344311234 |
| AGCO | 6289542M1 | A-6289542M1 |
| AGCO | 71430816 | A-71430816 |
| AGCO | E040T07 | A-E040T07 |
| AGCO | 6219415M1 | A-6219415M1 |
| AGCO | 71448515 | A-71448515 |
| AGCO | 6154285 | A-6154285 |
| AGCO | 6237302M1 | A-6237302M1 |
| AGCO | 7061016M1 | A-7061016M1 |
| AGCO | 1671988M1 | A-1671988M1 |
| AGCO | 700721267 | A-700721267 |
| AGCO | 344311309 | A-344311309 |
| AGCO | 344311311 | A-344311311 |
| AGCO | 6219414M1 | A-6219414M1 |
| AGCO | 6232589M1 | A-6232589M1 |
| AGCO | 344411318 | A-344411318 |
| AGCO | 6218984M1 | A-6218984M1 |
| AGCO | 344311239 | A-344311239 |
| AGCO | 6217825M1 | A-6217825M1 |
| AGCO | 344311313 | A-344311313 |
| AGCO | 26746973 | A-26746973 |
| AGCO | 6247944M1 | A-6247944M1 |
| AGCO | 7059737M1 | A-7059737M1 |
| AGCO | 6247230M1 | A-6247230M1 |
| AGCO | 71427343 | A-71427343 |
| AGCO | 6219408M1 | A-6219408M1 |
| AGCO | 28263409 | A-28263409 |



AGCO

| OEM | OEM  Part No. | PIX  Part No. |
|------|--|--|
| AGCO | 6272560M1 | A-6272560M1 |
| AGCO | 41994300 | A-41994300 |
| AGCO | 28264254 | A-28264254 |
| AGCO | 6153723 | A-6153723 |
| AGCO | 6153386 | A-6153386 |
| AGCO | 26749057 | A-26749057 |
| AGCO | 3920419M | A-3920419M |
| AGCO | 3920562M | A-3920562M |
| AGCO | 26746998 | A-26746998 |
| AGCO | 6247946M1 | A-6247946M1 |
| AGCO | 6237300M1 | A-6237300M1 |
| AGCO | 28263119 | A-28263119 |
| AGCO | 650.623.030.550 | A-650.623.030.550 |
| AGCO | 685061555 | A-685061555 |
| AGCO | V685061555 | A-V685061555 |
| AGCO | 685061585 | A-685061585 |
| AGCO | V685061585 | A-V685061585 |
| AGCO | 685061740 | A-685061740 |
| AGCO | V685061740 | A-V685061740 |
| AGCO | 685081290 | A-685081290 |
| AGCO | V685081290 | A-V685081290 |
| AGCO | 685081315 | A-685081315 |
| AGCO | V685081315 | A-V685081315 |
| AGCO | 685081680 | A-685081680 |
| AGCO | V685081680 | A-V685081680 |
| AGCO | 685081710 | A-685081710 |
| AGCO | V685081710 | A-V685081710 |
| AGCO | 685081730 | A-685081730 |
| AGCO | 685081745 | A-685081745 |
| AGCO | V685081745 | A-V685081745 |
| AGCO | F718202040010 | A-F718202040010 |
| AGCO | 685081800 | A-685081800 |
| AGCO | V685081800 | A-V685081800 |
| AGCO | 685081850 | A-685081850 |
| AGCO | V685081850 | A-V685081850 |
| AGCO | 685081895 | A-685081895 |
| AGCO | V685081895 | A-V685081895 |
| AGCO | 685081920 | A-685081920 |
| AGCO | V685081920 | A-V685081920 |
| AGCO | 500252D1 | A-500252D1 |
| AGCO | 500251D1 | A-500251D1 |
| AGCO | 685082300 | A-685082300 |
| AGCO | V685082300 | A-V685082300 |
| AGCO | F524200040160 | A-F524200040160 |
| AGCO | X696614700000 | A-X696614700000 |
| AGCO | X696615408000 | A-X696615408000 |
| AGCO | X696615600000 | A-X696615600000 |



| OEM | OEM  Part No. | PIX  Part No. |
|------|--|--|
| AGCO | X696610600000 | A-X696610600000 |
| AGCO | X696612313000 | A-X696612313000 |
| AGCO | X696612500000 | A-X696612500000 |
| AGCO | X696.612.900.000 | A-X696.612.900.000 |
| AGCO | X696612900000 | A-X696612900000 |
| AGCO | X696.613.313.000 | A-X696.613.313.000 |
| AGCO | X696613308000 | A-X696613308000 |
| AGCO | X696613313000 | A-X696613313000 |
| AGCO | X696613600000 | A-X696613600000 |
| AGCO | 684101000 | A-684101000 |
| AGCO | V684101000 | A-V684101000 |
| AGCO | 684101025 | A-684101025 |
| AGCO | V684101025 | A-V684101025 |
| AGCO | X696614513000 | A-X696614513000 |
| AGCO | X696.614.602.000 | A-X696.614.602.000 |
| AGCO | X696614601000 | A-X696614601000 |
| AGCO | 684101100 | A-684101100 |
| AGCO | V684101100 | A-V684101100 |
| AGCO | 684101125 | A-684101125 |
| AGCO | V684101125 | A-V684101125 |
| AGCO | 684101150 | A-684101150 |
| AGCO | V684101150 | A-V684101150 |
| AGCO | 056148T1 | A-056148T1 |
| AGCO | 684101175 | A-684101175 |
| AGCO | V684101175 | A-V684101175 |
| AGCO | X696613901000 | A-X696613901000 |
| AGCO | 684101238 | A-684101238 |
| AGCO | V684101238 | A-V684101238 |
| AGCO | X696616000000 | A-X696616000000 |
| AGCO | X696617900000 | A-X696617900000 |
| AGCO | X696612602000 | A-X696612602000 |
| AGCO | X696612400000 | A-X696612400000 |
| AGCO | 684101350 | A-684101350 |
| AGCO | V684101350 | A-V684101350 |
| AGCO | X696615301000 | A-X696615301000 |
| AGCO | 072729T1 | A-072729T1 |
| AGCO | 054315T1 | A-054315T1 |
| AGCO | 053650T1 | A-053650T1 |
| AGCO | 069998T1 | A-069998T1 |
| AGCO | 070460T1 | A-070460T1 |
| AGCO | X696.616.702.010 | A-X696.616.702.010 |
| AGCO | 069999T1 | A-069999T1 |
| AGCO | 070461T1 | A-070461T1 |
| AGCO | 6217950M1 | A-6217950M1 |
| AGCO | X696611611000 | A-X696611611000 |
| AGCO | X696616102000 | A-X696616102000 |
| AGCO | X696616300000 | A-X696616300000 |



AGCO

| OEM | OEM  Part No. | PIX  Part No. |
|------|--|--|
| AGCO | 056150T1 | A-056150T1 |
| AGCO | X696612811000 | A-X696612811000 |
| AGCO | X696613101000 | A-X696613101000 |
| AGCO | X696613801000 | A-X696613801000 |
| AGCO | X696640600000 | A-X696640600000 |
| AGCO | 6236823M1 | A-6236823M1 |
| AGCO | 684121050 | A-684121050 |
| AGCO | V684121050 | A-V684121050 |
| AGCO | 684121075 | A-684121075 |
| AGCO | V684121075 | A-V684121075 |
| AGCO | X696624600000 | A-X696624600000 |
| AGCO | 684121100 | A-684121100 |
| AGCO | 054607T1 | A-054607T1 |
| AGCO | V684121100 | A-V684121100 |
| AGCO | X696619200000 | A-X696619200000 |
| AGCO | 684121125 | A-684121125 |
| AGCO | V684121125 | A-V684121125 |
| AGCO | X696623700000 | A-X696623700000 |
| AGCO | 6201102M1 | A-6201102M1 |
| AGCO | 049798T1 | A-049798T1 |
| AGCO | X696623900000 | A-X696623900000 |
| AGCO | 1682684M2 | A-1682684M2 |
| AGCO | 6902 | A-0006902 |
| AGCO | V684121225 | A-V684121225 |
| AGCO | 684121225 | A-684121225 |
| AGCO | 684121250 | A-684121250 |
| AGCO | V684121250 | A-V684121250 |
| AGCO | X696624400000 | A-X696624400000 |
| AGCO | 6906 | A-0006906 |
| AGCO | 1482511M2 | A-1482511M2 |
| AGCO | 3148053M91 | A-3148053M91 |
| AGCO | 072727T1 | A-072727T1 |
| AGCO | 489734M2 | A-489734M2 |
| AGCO | 040560T1 | A-040560T1 |
| AGCO | 984909360 | A-984909360 |
| AGCO | 3815255M1 | A-3815255M1 |
| AGCO | 6201932M1 | A-6201932M1 |
| AGCO | 6201602M91 | A-6201602M91 |
| AGCO | 6203323M91 | A-6203323M91 |
| AGCO | 054269T1 | A-054269T1 |
| AGCO | 6900 | A-6900 |
| AGCO | 026160T1 | A-026160T1 |
| AGCO | 026161T1 | A-026161T1 |
| AGCO | 056149T1 | A-056149T1 |
| AGCO | 3145135M91 | A-3145135M91 |
| AGCO | 684121550 | A-684121550 |
| AGCO | V684121550 | A-V684121550 |

| OEM | OEM  Part No. | PIX  Part No. |
|------|--|--|
| AGCO | 684121575 | A-684121575 |
| AGCO | V684121575 | A-V684121575 |
| AGCO | 6214645M1 | A-6214645M1 |
| AGCO | 684121600 | A-684121600 |
| AGCO | V684121600 | A-V684121600 |
| AGCO | 036720T1 | A-036720T1 |
| AGCO | 684121625 | A-684121625 |
| AGCO | V684121625 | A-V684121625 |
| AGCO | 684121650 | A-684121650 |
| AGCO | V684121650 | A-V684121650 |
| AGCO | 684121675 | A-684121675 |
| AGCO | V684121675 | A-V684121675 |
| AGCO | 034699T1 | A-034699T1 |
| AGCO | 034948T1 | A-034948T1 |
| AGCO | 3587700M1 | A-3587700M1 |
| AGCO | 3587701M91 | A-3587701M91 |
| AGCO | 021077T1 | A-021077T1 |
| AGCO | 021078T1 | A-021078T1 |
| AGCO | X696622800000 | A-X696622800000 |
| AGCO | 684120825 | A-684120825 |
| AGCO | V684120825 | A-V684120825 |
| AGCO | 684120875 | A-684120875 |
| AGCO | V684120875 | A-V684120875 |
| AGCO | 684120900 | A-684120900 |
| AGCO | 684120918 | A-684120918 |
| AGCO | 684120925 | A-684120925 |
| AGCO | V684120925 | A-V684120925 |
| AGCO | 684120950 | A-684120950 |
| AGCO | V684120950 | A-V684120950 |
| AGCO | 684120975 | A-684120975 |
| AGCO | V684120975 | A-V684120975 |
| AGCO | 684120992 | A-684120992 |
| AGCO | V684120992 | A-V684120992 |
| AGCO | 7061235M1 | A-7061235M1 |
| AGCO | 10487 | A-10487 |
| AGCO | D41972300 | A-D41972300 |
| AGCO | 6230869M1 | A-6230869M1 |
| AGCO | 340433988 | A-340433988 |
| AGCO | 6230019M1 | A-6230019M1 |
| AGCO | 340433985 | A-340433985 |
| AGCO | 340433986 | A-340433986 |
| AGCO | 41978600 | A-41978600 |
| AGCO | 6275380M1 | A-6275380M1 |
| AGCO | 6275381M1 | A-6275381M1 |
| AGCO | 340435120K | A-340435120K |
| AGCO | 833857M5 | A-833857M5 |
| AGCO | 340435146K | A-340435146K |

AGCO



| OEM | OEM  Part No. | PIX  Part No. |
|------|--|--|
| AGCO | 069361T1 | A-069361T1 |
| AGCO | 069362T1 | A-069362T1 |
| AGCO | 344435155 | A-344435155 |
| AGCO | 41980500 | A-41980500 |
| AGCO | 117510515000 | A-117510515000 |
| AGCO | 6230012M1 | A-6230012M1 |
| AGCO | 6219396M1 | A-6219396M1 |
| AGCO | 124977 | A-124977 |
| AGCO | 41990007X | A-41990007X |
| AGCO | 6801631 | A-6801631 |
| AGCO | 650.203.040.010 | A-650.203.040.010 |
| AGCO | 7061926M1 | A-7061926M1 |
| AGCO | 41990027 | A-41990027 |
| AGCO | D41921801 | A-D41921801 |
| AGCO | 41921801 | A-41921801 |
| AGCO | 402608M3 | A-402608M3 |
| AGCO | X696614913000 | A-X696614913000 |
| AGCO | X696616913000 | A-X696616913000 |
| AGCO | X696612913000 | A-X696612913000 |
| AGCO | 6154847 | A-06154847 |
| AGCO | 1170290108 | A-1170-290-108.00 |
| AGCO | X696617701000 | A-X696617701000 |
| AGCO | 1976292 | A-197-6292 |
| AGCO | 1976290 | A-197-6290 |
| AGCO | 1123664101 | A-1123-664-101.00 |
| AGCO | 6155819 | A-06155819 |
| AGCO | 71444306 | A-71444306 |
| AGCO | Ag518702 | A-AG518702 |
| AGCO | Ag518297 | A-AG518297 |
| AGCO | Ag519946 | A-AG519946 |
| AGCO | Ag516760 | A-AG516760 |
| AGCO | 71380653 | A-71380653 |
| AGCO | 71381952 | A-71381952 |
| AGCO | 71440983 | A-71440983 |
| AGCO | 709979 | A-709979 |
| AGCO | 7855661 | A-7855661 |
| AGCO | 856328 | A-856328 |
| AGCO | 1D68066 | A-1D68066 |
| AGCO | 71390210 | A-71390210 |
| AGCO | 650623030550 | A-650623030550 |
| AGCO | 410215M1 | A-410215M1 |
| AGCO | V685081785 | A-V685081785 |
| AGCO | 650633020010 | A-650633020010 |
| AGCO | 651200010220 | A-651200010220 |
| AGCO | 650203010870 | A-650203010870 |
| AGCO | 2072949 | A-207-2949 |
| AGCO | X696611312000 | A-X696611312000 |

| OEM | OEM  Part No. | PIX  Part No. |
|------|--|--|
| AGCO | X696613902000 | A-X696613902000 |
| AGCO | 1686837M1 | A-1686837M1 |
| AGCO | 400875 | A-400875 |
| AGCO | 72028727 | A-72028727 |
| AGCO | 71409522 | A-71409522 |
| AGCO | 515757D1 | A-515757D1 |
| AGCO | Ag605632 | A-AG605632 |
| AGCO | Ag720324 | A-AG720324 |
| AGCO | 5016906M1 | A-5016906M1 |
| AGCO | 520305D1 | A-520305D1 |
| AGCO | Ag027148 | A-AG027148 |
| AGCO | 71399607 | A-71399607 |
| AGCO | Ag605631 | A-AG605631 |
| AGCO | 740640 | A-740640 |
| AGCO | 72120245 | A-72120245 |
| AGCO | 72120454 | A-72120454 |
| AGCO | 72120455 | A-72120455 |
| AGCO | 1057488M1 | A-1057488M1 |
| AGCO | 1055562M1 | A-1055562M1 |
| AGCO | 1065431M1 | A-1065431M1 |
| AGCO | 1042396M1 | A-1042396M1 |
| AGCO | Ag516922 | A-AG516922 |
| AGCO | 700704407 | A-700704407 |
| AGCO | 76171 | A-7617-1 |
| AGCO | 76172 | A-7617-2 |
| AGCO | Wr38791 | A-WR38791 |
| AGCO | 71500256 | A-71500256 |
| AGCO | Y855106 | A-Y855106 |
| AGCO | 742527 | A-742527 |
| AGCO | 834191M1 | A-834191M1 |
| AGCO | 743800 | A-743800 |
| AGCO | H153301C1 | A-H153301C1 |
| AGCO | W9810080 | A-W9810080 |
| AGCO | 740726 | A-740726 |
| AGCO | 70548863 | A-70548863 |
| AGCO | 747255 | A-747255 |
| AGCO | Y56580 | A-Y56580 |
| AGCO | Y57604 | A-Y57604 |
| AGCO | 70805114 | A-70805114 |
| AGCO | Y855254 | A-Y855254 |
| AGCO | H143876C1 | A-H143876C1 |
| AGCO | 747256 | A-747256 |
| AGCO | 857805 | A-857805 |
| AGCO | 747254 | A-747254 |
| AGCO | 743795 | A-743795 |
| AGCO | 71380655 | A-71380655 |
| AGCO | H143875C1 | A-H143875C1 |





AGCO

| OEM | OEM  Part No. | PIX  Part No. |
|------|--|--|
| AGCO | 744282 | A-744282 |
| AGCO | 56333 | A-56333 |
| AGCO | Y57083 | A-Y57083 |
| AGCO | 856062 | A-856062 |
| AGCO | 7855224 | A-7855224 |
| AGCO | N712489 | A-N712489 |
| AGCO | Y57760 | A-Y57760 |
| AGCO | 70548868 | A-70548868 |
| AGCO | 71130179 | A-71130179 |
| AGCO | 71140810 | A-71140810 |
| AGCO | 71172514 | A-71172514 |
| AGCO | 70508971 | A-70508971 |
| AGCO | 71381413 | A-71381413 |
| AGCO | 71364789 | A-71364789 |
| AGCO | 1175105150 | A-1175-105-150.00 |
| AGCO | 6627918 | A-6627918 |
| AGCO | 650203040011 | A-650203040010 |
| AGCO | D41979800 | A-D41979800 |
| AGCO | 55574 | A-0000055574 |
| AGCO | 6215259 | A-6215259 |
| AGCO | 3443111171 | A-3443111171 |
| AGCO | 340433198 | A-340433198 |
| AGCO | 340433197 | A-340433197 |
| AGCO | 340433476 | A-340433476 |
| AGCO | 340433985 | A-340433985 |
| AGCO | 340433986 | A-340433986 |



ALLIS GLEANER

| OEM | OEM  Part No. | PIX  Part No. |
|---------------|--|--|
| ALLIS GLEANER | 71336199 | A-71336199 |
| ALLIS GLEANER | 71312339 | A-71312339 |
| ALLIS GLEANER | 71188075 | A-71188075 |
| ALLIS GLEANER | 71316263 | A-71316263 |
| ALLIS GLEANER | 71319657 | A-71319657 |
| ALLIS GLEANER | 71325847 | A-71325847 |
| ALLIS GLEANER | 71339772 | A-71339772 |
| ALLIS GLEANER | 71354210 | A-71354210 |
| ALLIS GLEANER | 71358486 | A-71358486 |
| ALLIS GLEANER | 71363968 | A-71363968 |
| ALLIS GLEANER | 71139961 | A-71139961 |
| ALLIS GLEANER | 71153532 | A-71153532 |
| ALLIS GLEANER | 71194122 | A-71194122 |
| ALLIS GLEANER | 1320449 | A-1320449 |
| ALLIS GLEANER | 1336210 | A-1336210 |
| ALLIS GLEANER | 71183767 | A-71183767 |
| ALLIS GLEANER | 71358134 | A-71358134 |
| ALLIS GLEANER | 1322418 | A-1322418 |
| ALLIS GLEANER | 1347561 | A-1347561 |
| ALLIS GLEANER | 1347560 | A-1347560 |
| ALLIS GLEANER | 1175713 | A-1175713 |
| ALLIS GLEANER | 1176492 | A-1176492 |
| ALLIS GLEANER | 1334919 | A-1334919 |
| ALLIS GLEANER | 1316263 | A-1316263 |
| ALLIS GLEANER | 1309140 | A-1309140 |
| ALLIS GLEANER | 1328523 | A-1328523 |
| ALLIS GLEANER | 1339886 | A-1339886 |
| ALLIS GLEANER | 1325847 | A-1325847 |
| ALLIS GLEANER | 1118003 | A-1118003 |
| ALLIS GLEANER | 1309685 | A-1309685 |
| ALLIS GLEANER | 1188635 | A-1188635 |
| ALLIS GLEANER | 1139961 | A-1139961 |
| ALLIS GLEANER | 1189170 | A-1189170 |
| ALLIS GLEANER | 1337795 | A-1337795 |
| ALLIS GLEANER | 1147547 | A-1147547 |
| ALLIS GLEANER | 1147546 | A-1147546 |
| ALLIS GLEANER | 1310382 | A-1310382 |
| ALLIS GLEANER | 1164177 | A-1164177 |
| ALLIS GLEANER | 1309214 | A-1309214 |
| ALLIS GLEANER | 1161595 | A-1161595 |
| ALLIS GLEANER | 1342142 | A-1342142 |
| ALLIS GLEANER | 1165927 | A-1165927 |
| ALLIS GLEANER | 1139966 | A-1139966 |
| ALLIS GLEANER | 1188636 | A-1188636 |
| ALLIS GLEANER | 1177537 | A-1177537 |
| ALLIS GLEANER | 1173998 | A-1173998 |
| ALLIS GLEANER | 1336997 | A-1336997 |

ALLIS GLEANER

| OEM | OEM  Part No. | PIX  Part No. | OEM | OEM  Part No. | PIX  Part No. |
|---------------|--|--|---------------|--|--|
| ALLIS GLEANER | 1348999 | A-1348999 | ALLIS GLEANER | 1197878 | A-1197878 |
| ALLIS GLEANER | 1342143 | A-1342143 | ALLIS GLEANER | 11978782 | A-1197878-2 |
| ALLIS GLEANER | 1164350 | A-1164350 | ALLIS GLEANER | 1184327 | A-1184327 |
| ALLIS GLEANER | 1310381 | A-1310381 | ALLIS GLEANER | 1309571 | A-1309571 |
| ALLIS GLEANER | 1307200 | A-1307200 | ALLIS GLEANER | 1345785 | A-1345785 |
| ALLIS GLEANER | 1176400 | A-1176400 | ALLIS GLEANER | 70559863 | A-70559863 |
| ALLIS GLEANER | 1319657 | A-1319657 | ALLIS GLEANER | 1119007 | A-1119007 |
| ALLIS GLEANER | 1300867 | A-1300867 | ALLIS GLEANER | 71320499 | A-71320499 |
| ALLIS GLEANER | 1139622 | A-1139622 | ALLIS GLEANER | 713645141 | A-71364514-1 |
| ALLIS GLEANER | 1324690 | A-1324690 | ALLIS GLEANER | 1172562 | A-1172562 |
| ALLIS GLEANER | 1326830 | A-1326830 | ALLIS GLEANER | 621089 | A-621089 |
| ALLIS GLEANER | 1187728 | A-1187728 | ALLIS GLEANER | 1186454 | A-1186454 |
| ALLIS GLEANER | 1310380 | A-1310380 | ALLIS GLEANER | 1306200 | A-1306200 |
| ALLIS GLEANER | 1139962 | A-1139962 | ALLIS GLEANER | 1177795 | A-1177795 |
| ALLIS GLEANER | 1309150 | A-1309150 | ALLIS GLEANER | 1183251 | A-1183251 |
| ALLIS GLEANER | 1313804 | A-1313804 | ALLIS GLEANER | 1342839 | A-1342839 |
| ALLIS GLEANER | 1306291 | A-1306291 | ALLIS GLEANER | 71342839 | A-71342839 |
| ALLIS GLEANER | 1135618 | A-1135618 | ALLIS GLEANER | 1340653 | A-1340653 |
| ALLIS GLEANER | 1139963 | A-1139963 | ALLIS GLEANER | 1321691 | A-1321691 |
| ALLIS GLEANER | 1300996 | A-1300996 | ALLIS GLEANER | 1337000 | A-1337000 |
| ALLIS GLEANER | 1318378 | A-1318378 | ALLIS GLEANER | 1349687 | A-1349687 |
| ALLIS GLEANER | 1316268 | A-1316268 | ALLIS GLEANER | 71349687 | A-71349687 |
| ALLIS GLEANER | 1167114 | A-1167114 | ALLIS GLEANER | 1305090 | A-1305090 |
| ALLIS GLEANER | 1188155 | A-1188155 | ALLIS GLEANER | 1321590 | A-1321590 |
| ALLIS GLEANER | 1194500 | A-1194500 | ALLIS GLEANER | 1342690 | A-1342690 |
| ALLIS GLEANER | 1302482 | A-1302482 | ALLIS GLEANER | 1309967 | A-1309967 |
| ALLIS GLEANER | 1336307 | A-1336307 | ALLIS GLEANER | 71361155 | A-71361155 |
| ALLIS GLEANER | 1346200 | A-1346200 | ALLIS GLEANER | 71336210 | A-71336210 |
| ALLIS GLEANER | 71359681 | A-71359681 | ALLIS GLEANER | 1125976 | A-1125976 |
| ALLIS GLEANER | 71333673 | A-71333673 | ALLIS GLEANER | 71351992 | A-71351992 |
| ALLIS GLEANER | 1188075 | A-1188075 | ALLIS GLEANER | 1322395 | A-1322395 |
| ALLIS GLEANER | 1177548 | A-1177548 | ALLIS GLEANER | 1135748 | A-1135748 |
| ALLIS GLEANER | 1325150 | A-1325150 | ALLIS GLEANER | 71135748 | A-71135748 |
| ALLIS GLEANER | 1159351 | A-1159351 | ALLIS GLEANER | 1116659 | A-1116659 |
| ALLIS GLEANER | 1164776 | A-1164776 | ALLIS GLEANER | 1172514 | A-1172514 |
| ALLIS GLEANER | 1159352 | A-1159352 | ALLIS GLEANER | 70527095 | A-70527095 |
| ALLIS GLEANER | 71344423 | A-71344423 | ALLIS GLEANER | 1197876 | A-1197876 |
| ALLIS GLEANER | 71330756 | A-71330756 | ALLIS GLEANER | 71375178 | A-71375178 |
| ALLIS GLEANER | 1197999 | A-1197999 | ALLIS GLEANER | 713641546 | A-71364154-6 |
| ALLIS GLEANER | 1188638 | A-1188638 | ALLIS GLEANER | 1125975 | A-1125975 |
| ALLIS GLEANER | 1314273 | A-1314273 | ALLIS GLEANER | 1170490 | A-1170490 |
| ALLIS GLEANER | 1334993 | A-1334993 | ALLIS GLEANER | 30653380 | A-30653-380 |
| ALLIS GLEANER | 1336993 | A-1336993 | ALLIS GLEANER | 71355788 | A-71355788 |
| ALLIS GLEANER | 1348989 | A-1348989 | ALLIS GLEANER | 1197899 | A-1197899 |
| ALLIS GLEANER | 71390120 | A-71390120 | ALLIS GLEANER | 1328562 | A-1328562 |
| ALLIS GLEANER | 1301877 | A-1301877 | ALLIS GLEANER | 71328562 | A-71328562 |
| ALLIS GLEANER | 1312339 | A-1312339 | ALLIS GLEANER | 1399514 | A-1399514 |



ALLIS GLEANER

| OEM | OEM  Part No. | PIX  Part No. |
|---------------|--|--|
| ALLIS GLEANER | 71363246 | A-71363246 |

BIZON

| | | |
|-------|-------------|----------------|
| BIZON | 9515076 | A-9515076 |
| BIZON | 825117 | A-825117 |
| BIZON | 9515075 | A-9515075 |
| BIZON | 9818873 | A-9818873 |
| BIZON | 51101131525 | A-51101131525 |
| BIZON | 51101131570 | A-51101131570 |
| BIZON | 51101132800 | A-51101132800 |
| BIZON | 51101171335 | A-51101171335 |
| BIZON | 51101171375 | A-51101171375 |
| BIZON | 51101171750 | A-51101171750 |
| BIZON | 51101171981 | A-51101171981 |
| BIZON | 51101172438 | A-51101172438 |
| BIZON | 51101222525 | A-51101222525 |
| BIZON | 51101321750 | A-51101321750 |
| BIZON | 51101622375 | A-51101622375 |
| BIZON | 51102173550 | A-51102173550 |
| BIZON | 51103172120 | A-51103172120 |
| BIZON | 51103172380 | A-51103172380 |
| BIZON | 51103172650 | A-51103172650 |
| BIZON | 51103173062 | A-51103173062 |
| BIZON | 51103173220 | A-51103173220 |
| BIZON | 51104172270 | A-51104172270 |
| BIZON | 51104173940 | A-51104173940 |
| BIZON | 51651222360 | A-51651222360 |
| BIZON | 51101132175 | A-51101132175 |
| BIZON | 51101171670 | A-51101171670 |
| BIZON | 51101171800 | A-51101171800 |
| BIZON | 51651175000 | A-51651175000 |
| BIZON | 51101222360 | A-51101222360 |
| BIZON | 51202175000 | A-51202175000 |
| BIZON | 84026042 | A-84026042 |
| BIZON | 84996133 | A-84996133 |
| BIZON | 615146 | A-615146 |
| BIZON | 51651221725 | A-51651221725 |
| BIZON | 51101255970 | A-51101255970 |
| BIZON | 51654172420 | A-51654172420 |
| BIZON | 639226.1 | A-639226.1 |
| BIZON | 614136 | A-614136 |
| BIZON | 615116 | A-615116 |
| BIZON | 51652172210 | A-51652172210 |
| BIZON | 972511286 | A-972511286 |
| BIZON | 1374310409 | A-1374-310-409 |
| BIZON | 51101173861 | A-51101173861 |



BIZON



| OEM | OEM  Part No. | PIX  Part No. |
|-------|--|--|
| BIZON | 972411280 | A-972411280 |
| BIZON | 615146 | A-615146 |
| BIZON | 614136 | A-614136 |
| BIZON | 615116 | A-615116 |

CASE IH



| | | |
|---------|------------|--------------|
| CASE IH | 440498A3 | A-440498A3 |
| CASE IH | 4221668157 | A-4221668157 |
| CASE IH | 87564450 | A-87564450 |
| CASE IH | 87527868 | A-87527868 |
| CASE IH | 380041A1 | A-380041A1 |
| CASE IH | 402368A1 | A-402368A1 |
| CASE IH | 402370A1 | A-402370A1 |
| CASE IH | A77938 | A-A77938 |
| CASE IH | 431784 | A-431784 |
| CASE IH | 5094418 | A-5094418 |
| CASE IH | A138001 | A-A138001 |
| CASE IH | 462133R1 | A-462133R1 |
| CASE IH | 400427A1 | A-400427A1 |
| CASE IH | 500371653 | A-500371653 |
| CASE IH | 317904A1 | A-317904A1 |
| CASE IH | 87282305 | A-87282305 |
| CASE IH | 87061591 | A-87061591 |
| CASE IH | 80921330 | A-80921330 |
| CASE IH | 825013 | A-825013 |
| CASE IH | 87375325 | A-87375325 |
| CASE IH | 4032808262 | A-4032808262 |
| CASE IH | 5140009 | A-5140009 |
| CASE IH | 87309958 | A-87309958 |
| CASE IH | 87402831 | A-87402831 |
| CASE IH | 87282333 | A-87282333 |
| CASE IH | 500369112 | A-500369112 |
| CASE IH | 98473705 | A-98473705 |
| CASE IH | 5140010 | A-5140010 |
| CASE IH | 4809680 | A-4809680 |
| CASE IH | 1966512C1 | A-1966512C1 |
| CASE IH | 47129821 | A-47129821 |
| CASE IH | 86514611 | A-86514611 |
| CASE IH | 86514616 | A-86514616 |
| CASE IH | 87567471 | A-87567471 |
| CASE IH | 87800129 | A-87800129 |
| CASE IH | 1806189C1 | A-1806189C1 |
| CASE IH | 5154152 | A-5154152 |
| CASE IH | 4760486 | A-4760486 |
| CASE IH | 84817624 | A-84817624 |
| CASE IH | 87300105 | A-87300105 |
| CASE IH | 87437226 | A-87437226 |



CASE IH

| OEM | OEM  Part No. | PIX  Part No. |
|---------|--|--|
| CASE IH | 87366407 | A-87366407 |
| CASE IH | 87840341 | A-87840341 |
| CASE IH | 87531428 | A-87531428 |
| CASE IH | 87441272 | A-87441272 |
| CASE IH | 87325327 | A-87325327 |
| CASE IH | A189040 | A-A189040 |
| CASE IH | 87301455 | A-87301455 |
| CASE IH | 244423A3 | A-244423A3 |
| CASE IH | 334065 | A-334065 |
| CASE IH | 603720 | A-603720 |
| CASE IH | 413159A1 | A-413159A1 |
| CASE IH | 274224 | A-274224 |
| CASE IH | 490489R2 | A-490489R2 |
| CASE IH | 49341D | A-49341D |
| CASE IH | 55418 | A-55418 |
| CASE IH | 558141R1 | A-558141R1 |
| CASE IH | 700713435 | A-700713435 |
| CASE IH | 700714715 | A-700714715 |
| CASE IH | 829131C1 | A-829131C1 |
| CASE IH | A59762 | A-A59762 |
| CASE IH | A65717 | A-A65717 |
| CASE IH | 86627796 | A-86627796 |
| CASE IH | 87317063 | A-87317063 |
| CASE IH | 393750A1 | A-393750A1 |
| CASE IH | 84817625 | A-84817625 |
| CASE IH | 84817631 | A-84817631 |
| CASE IH | 84817634 | A-84817634 |
| CASE IH | 323646 | A-323646 |
| CASE IH | 356024 | A-356024 |
| CASE IH | 356025 | A-356025 |
| CASE IH | 387469 | A-387469 |
| CASE IH | 422731 | A-422731 |
| CASE IH | 424563 | A-424563 |
| CASE IH | 753053 | A-753053 |
| CASE IH | 31301147 | A-31301147 |
| CASE IH | 31318645 | A-31318645 |
| CASE IH | 80046914 | A-80046914 |
| CASE IH | 80913524 | A-80913524 |
| CASE IH | 84058255 | A-84058255 |
| CASE IH | 84074273 | A-84074273 |
| CASE IH | 87628477 | A-87628477 |
| CASE IH | 4131775313 | A-4131775313 |
| CASE IH | 4131781055 | A-4131781055 |
| CASE IH | 4240053761 | A-4240053761 |
| CASE IH | 4255643332 | A-4255643332 |
| CASE IH | 9911861524 | A-9911861524 |
| CASE IH | 9911861901 | A-9911861901 |



| OEM | OEM  Part No. | PIX  Part No. |
|---------|--|--|
| CASE IH | 9911862043 | A-9911862043 |
| CASE IH | 51102171670 | A-51102171670 |
| CASE IH | 51102174610 | A-51102174610 |
| CASE IH | 3129140R1 | A-3129140R1 |
| CASE IH | 86975809 | A-86975809 |
| CASE IH | 80396749 | A-80396749 |
| CASE IH | 84172256 | A-84172256 |
| CASE IH | 87283139 | A-87283139 |
| CASE IH | 87673234 | A-87673234 |
| CASE IH | 60206971 | A-060206971 |
| CASE IH | 61068968 | A-061068968 |
| CASE IH | 107671C1 | A-107671C1 |
| CASE IH | 131403C1 | A-131403C1 |
| CASE IH | 320344A1 | A-320344A1 |
| CASE IH | 52318DA | A-52318DA |
| CASE IH | A145325 | A-A145325 |
| CASE IH | A18426 | A-A18426 |
| CASE IH | A30585 | A-A30585 |
| CASE IH | A61048 | A-A61048 |
| CASE IH | A65143 | A-A65143 |
| CASE IH | A78022 | A-A78022 |
| CASE IH | 403617R1 | A-403617R1 |
| CASE IH | 244422A4 | A-244422A4 |
| CASE IH | 48032DA | A-48032DA |
| CASE IH | 86011009 | A-86011009 |
| CASE IH | 86013678 | A-86013678 |
| CASE IH | A22766 | A-A22766 |
| CASE IH | T38546 | A-T38546 |
| CASE IH | J911567 | A-J911567 |
| CASE IH | J911580 | A-J911580 |
| CASE IH | 439129 | A-439129 |
| CASE IH | 755808 | A-755808 |
| CASE IH | 9575059 | A-9575059 |
| CASE IH | 4031832698 | A-4031832698 |
| CASE IH | 4032804396 | A-4032804396 |
| CASE IH | 4032807784 | A-4032807784 |
| CASE IH | 4131775305 | A-4131775305 |
| CASE IH | 123306A1 | A-123306A1 |
| CASE IH | 16131DA | A-16131DA |
| CASE IH | 244420A4 | A-244420A4 |
| CASE IH | 244422A3 | A-244422A3 |
| CASE IH | J911557 | A-J911557 |
| CASE IH | K903050 | A-K903050 |
| CASE IH | 47131754 | A-47131754 |
| CASE IH | 87800858 | A-87800858 |
| CASE IH | J911561 | A-J911561 |
| CASE IH | 403348R1 | A-403348R1 |



CASE IH

| OEM | OEM  Part No. | PIX  Part No. |
|---------|--|--|
| CASE IH | 396830R1 | A-396830R1 |
| CASE IH | 385738R1 | A-385738R1 |
| CASE IH | 244423A1 | A-244423A1 |
| CASE IH | 193923C4 | A-193923C4 |
| CASE IH | 9604339 | A-9604339 |
| CASE IH | 87699094 | A-87699094 |
| CASE IH | K311714 | A-K311714 |
| CASE IH | 87402830 | A-87402830 |
| CASE IH | 87441267 | A-87441267 |
| CASE IH | 243373A1 | A-243373A1 |
| CASE IH | 48878D | A-48878D |
| CASE IH | 49291D | A-49291D |
| CASE IH | 237153R1 | A-237153R1 |
| CASE IH | 380060R1 | A-380060R1 |
| CASE IH | 60712D | A-60712D |
| CASE IH | 46869D | A-46869D |
| CASE IH | 532746R2 | A-532746R2 |
| CASE IH | 385120R2 | A-385120R2 |
| CASE IH | 534311R1 | A-534311R1 |
| CASE IH | 532030R2 | A-532030R2 |
| CASE IH | A135265 | A-A135265 |
| CASE IH | 80130C1 | A-80130C1 |
| CASE IH | 362828R1 | A-362828R1 |
| CASE IH | 68386C1 | A-68386C1 |
| CASE IH | 530076R1 | A-530076R1 |
| CASE IH | 367697R1 | A-367697R1 |
| CASE IH | 251428R1 | A-251428R1 |
| CASE IH | 434044 | A-434044 |
| CASE IH | 330715 | A-330715 |
| CASE IH | 230056 | A-230056 |
| CASE IH | 9911860435 | A-9911860435 |
| CASE IH | 230078 | A-230078 |
| CASE IH | 321559 | A-321559 |
| CASE IH | 230077 | A-230077 |
| CASE IH | 84078581 | A-84078581 |
| CASE IH | 1410094R1 | A-1410094R1 |
| CASE IH | 3157009R1 | A-3157009R1 |
| CASE IH | 3155127R1 | A-3155127R1 |
| CASE IH | 794464R2 | A-794464R2 |
| CASE IH | 446970 | A-446970 |
| CASE IH | 194528C2 | A-194528C2 |
| CASE IH | 325289A1 | A-325289A1 |
| CASE IH | 87747431 | A-87747431 |
| CASE IH | 87489502 | A-87489502 |
| CASE IH | 3228131R1 | A-3228131R1 |
| CASE IH | 3228279R1 | A-3228279R1 |
| CASE IH | 1319245C1 | A-1319245C1 |



| OEM | OEM  Part No. | PIX  Part No. |
|---------|--|--|
| CASE IH | 151529R2 | A-151529R2 |
| CASE IH | 23898K | A-23898K |
| CASE IH | 247430A1 | A-247430A1 |
| CASE IH | 319904A1 | A-319904A1 |
| CASE IH | 65337C2 | A-65337C2 |
| CASE IH | 829627C1 | A-829627C1 |
| CASE IH | 86582818 | A-86582818 |
| CASE IH | 86627791 | A-86627791 |
| CASE IH | 89817249 | A-89817249 |
| CASE IH | 937931R1 | A-937931R1 |
| CASE IH | A28129 | A-A28129 |
| CASE IH | A34820 | A-A34820 |
| CASE IH | 86514615 | A-86514615 |
| CASE IH | 86633896 | A-86633896 |
| CASE IH | 1315074C2 | A-1315074C2 |
| CASE IH | 1316573C2 | A-1316573C2 |
| CASE IH | 1336609C1 | A-1336609C1 |
| CASE IH | 333958 | A-333958 |
| CASE IH | 378989 | A-378989 |
| CASE IH | 86627810 | A-86627810 |
| CASE IH | R32782 | A-R32782 |
| CASE IH | 60206963 | A-060206963 |
| CASE IH | 61009396 | A-061009396 |
| CASE IH | 704449R1 | A-704449R1 |
| CASE IH | 84449662 | A-84449662 |
| CASE IH | 60067605 | A-60067605 |
| CASE IH | 447031 | A-447031 |
| CASE IH | 440780 | A-440780 |
| CASE IH | 84005861 | A-84005861 |
| CASE IH | 4895249 | A-4895249 |
| CASE IH | 87397416 | A-87397416 |
| CASE IH | 84023913 | A-84023913 |
| CASE IH | 31302076 | A-31302076 |
| CASE IH | 1170157 | A-1170157 |
| CASE IH | 87354138 | A-87354138 |
| CASE IH | 31275280N1 | A-31275280N1 |
| CASE IH | 3119750R1 | A-3119750R1 |
| CASE IH | K913631 | A-K913631 |
| CASE IH | 89831701 | A-89831701 |
| CASE IH | 89831704 | A-89831704 |
| CASE IH | 140100060001 | A-140100060001 |
| CASE IH | 130100060017 | A-130100060017 |
| CASE IH | 130100060018 | A-130100060018 |
| CASE IH | 84995734 | A-84995734 |
| CASE IH | 87373569 | A-87373569 |
| CASE IH | K308448 | A-K308448 |
| CASE IH | 1113936 | A-1113936 |



CASE IH

| OEM | OEM  Part No. | PIX  Part No. |
|---------|--|--|
| CASE IH | 238990A1 | A-238990A1 |
| CASE IH | 84817670 | A-84817670 |
| CASE IH | 84449518 | A-84449518 |
| CASE IH | 83949803 | A-83949803 |
| CASE IH | 754165 | A-754165 |
| CASE IH | 87354141 | A-87354141 |
| CASE IH | 81549846 | A-81549846 |
| CASE IH | 89831736 | A-89831736 |
| CASE IH | 89831738 | A-89831738 |
| CASE IH | 89831739 | A-89831739 |
| CASE IH | 81845565 | A-81845565 |
| CASE IH | 3218952R1 | A-3218952R1 |
| CASE IH | 89831749 | A-89831749 |
| CASE IH | 98490935 | A-98490935 |
| CASE IH | 397175R1 | A-397175R1 |
| CASE IH | 378113R2 | A-378113R2 |
| CASE IH | 385674R1 | A-385674R1 |
| CASE IH | 394013R1 | A-394013R1 |
| CASE IH | 132000130021 | A-132000130021 |
| CASE IH | 379966R2 | A-379966R2 |
| CASE IH | 140100130132 | A-140100130132 |
| CASE IH | 142000060001 | A-142000060001 |
| CASE IH | 142000060011 | A-142000060011 |
| CASE IH | 139900130003 | A-139900130003 |
| CASE IH | 142000060012 | A-142000060012 |
| CASE IH | 162000060005 | A-162000060005 |
| CASE IH | 59969C91 | A-59969C91 |
| CASE IH | 379629R1 | A-379629R1 |
| CASE IH | 162000130004 | A-162000130004 |
| CASE IH | 393519 | A-393519 |
| CASE IH | 500380059 | A-500380059 |
| CASE IH | 87802644 | A-87802644 |
| CASE IH | 82010895 | A-82010895 |
| CASE IH | 87802911 | A-87802911 |
| CASE IH | 82850750 | A-82850750 |
| CASE IH | 82850752 | A-82850752 |
| CASE IH | J911587 | A-J911587 |
| CASE IH | 87415774 | A-87415774 |
| CASE IH | 85826230 | A-85826230 |
| CASE IH | J925953 | A-J925953 |
| CASE IH | J911571 | A-J911571 |
| CASE IH | J911563 | A-J911563 |
| CASE IH | 4899178 | A-4899178 |
| CASE IH | J911573 | A-J911573 |
| CASE IH | J911559 | A-J911559 |
| CASE IH | J911566 | A-J911566 |
| CASE IH | J911564 | A-J911564 |



| OEM | OEM  Part No. | PIX  Part No. |
|---------|--|--|
| CASE IH | 2853208 | A-2853208 |
| CASE IH | 2856151 | A-2856151 |
| CASE IH | 437033 | A-437033 |
| CASE IH | 60500044 | A-60500044 |
| CASE IH | 340433153 | A-340433153 |
| CASE IH | 84073615 | A-84073615 |
| CASE IH | 86595191 | A-86595191 |
| CASE IH | 61067790 | A-61067790 |
| CASE IH | 80159837 | A-80159837 |
| CASE IH | 31317917 | A-31317917 |
| CASE IH | 913524 | A-913524 |
| CASE IH | 84026892 | A-84026892 |
| CASE IH | 87061270 | A-87061270 |
| CASE IH | 84026668 | A-84026668 |
| CASE IH | 87027209 | A-87027209 |
| CASE IH | 80746891 | A-80746891 |
| CASE IH | 84440188 | A-84440188 |
| CASE IH | 452864R1 | A-452864R1 |
| CASE IH | 790522R1 | A-790522R1 |
| CASE IH | 60187284 | A-60187284 |
| CASE IH | 214522C1 | A-214522C1 |
| CASE IH | 87393905 | A-87393905 |
| CASE IH | 1113501 | A-01113501 |
| CASE IH | 84041094 | A-84041094 |
| CASE IH | 86988710 | A-86988710 |
| CASE IH | 61036454 | A-61036454 |
| CASE IH | 89819509 | A-89819509 |
| CASE IH | 84996134 | A-84996134 |
| CASE IH | 31343437 | A-31343437 |
| CASE IH | 1101811 | A-1101811 |
| CASE IH | 60519150 | A-60519150 |
| CASE IH | 87368902 | A-87368902 |
| CASE IH | 84817637 | A-84817637 |
| CASE IH | 87628478 | A-87628478 |
| CASE IH | 84041095 | A-84041095 |
| CASE IH | 87346514 | A-87346514 |
| CASE IH | 1407123R1 | A-1407123R1 |
| CASE IH | 84054417 | A-84054417 |
| CASE IH | 61068935 | A-61068935 |
| CASE IH | 60068286 | A-60068286 |
| CASE IH | 9817374 | A-9817374 |
| CASE IH | 60067590 | A-60067590 |
| CASE IH | 393751A1 | A-393751A1 |
| CASE IH | 84459680 | A-84459680 |
| CASE IH | 84435248 | A-84435248 |
| CASE IH | 851792 | A-851792 |
| CASE IH | 1170011 | A-1170011 |



CASE IH

| OEM | OEM  Part No. | PIX  Part No. |
|---------|--|--|
| CASE IH | 9593464 | A-9593464 |
| CASE IH | 60124334 | A-60124334 |
| CASE IH | 743877 | A-743877 |
| CASE IH | 61068927 | A-61068927 |
| CASE IH | 61068943 | A-61068943 |
| CASE IH | 89516212 | A-89516212 |
| CASE IH | 84449232 | A-84449232 |
| CASE IH | 84448759 | A-84448759 |
| CASE IH | 84449861 | A-84449861 |
| CASE IH | 1169991 | A-1169991 |
| CASE IH | 1170116 | A-1170116 |
| CASE IH | 1170124 | A-1170124 |
| CASE IH | 3069379R1 | A-3069379R1 |
| CASE IH | 84045751 | A-84045751 |
| CASE IH | 427456 | A-427456 |
| CASE IH | 674965R1 | A-674965R1 |
| CASE IH | 756900 | A-756900 |
| CASE IH | 84817621 | A-84817621 |
| CASE IH | 450511 | A-450511 |
| CASE IH | 89505865 | A-89505865 |
| CASE IH | 61068976 | A-61068976 |
| CASE IH | 60067638 | A-60067638 |
| CASE IH | 1725666 | A-1725666 |
| CASE IH | 1590486 | A-1590486 |
| CASE IH | 60206988 | A-60206988 |
| CASE IH | 87531466 | A-87531466 |
| CASE IH | 1170060 | A-1170060 |
| CASE IH | 3129139R1 | A-3129139R1 |
| CASE IH | A184652 | A-A184652 |
| CASE IH | 228332A2 | A-228332A2 |
| CASE IH | 920019592 | A-920019592 |
| CASE IH | 401191R1 | A-401191R1 |
| CASE IH | 9818705 | A-9818705 |
| CASE IH | 1108520 | A-01108520 |
| CASE IH | 395539R1 | A-395539R1 |
| CASE IH | 1111725 | A-1111725 |
| CASE IH | 60187034 | A-60187034 |
| CASE IH | K912196 | A-K912196 |
| CASE IH | K68073 | A-K68073 |
| CASE IH | 80516776 | A-80516776 |
| CASE IH | P938712 | A-P938712 |
| CASE IH | 388280 | A-388280 |
| CASE IH | 465059 | A-465059 |
| CASE IH | 465058 | A-465058 |
| CASE IH | 72049753 | A-72049753 |
| CASE IH | 80446970 | A-80446970 |
| CASE IH | E128625 | A-E128625 |



| OEM | OEM  Part No. | PIX  Part No. |
|---------|--|--|
| CASE IH | 1111678 | A-1111678 |
| CASE IH | 61069036 | A-061069036 |
| CASE IH | 31310695 | A-31310695 |
| CASE IH | 700710498 | A-700710498 |
| CASE IH | 1546118C1 | A-1546118C1 |
| CASE IH | 1313094C1 | A-1313094C1 |
| CASE IH | 1338328C1 | A-1338328C1 |
| CASE IH | 87283315 | A-87283315 |
| CASE IH | 86517680 | A-86517680 |
| CASE IH | 87351975 | A-87351975 |
| CASE IH | 9800111 | A-9800111 |
| CASE IH | 1710326 | A-1710326 |
| CASE IH | 235414A1 | A-235414A1 |
| CASE IH | 857938 | A-857938 |
| CASE IH | 403580R1 | A-403580R1 |
| CASE IH | 527621R1 | A-527621R1 |
| CASE IH | 534310R1 | A-534310R1 |
| CASE IH | 401691R1 | A-401691R1 |
| CASE IH | 857029 | A-857029 |
| CASE IH | 403303R1 | A-403303R1 |
| CASE IH | 80754423 | A-80754423 |
| CASE IH | 89833888 | A-89833888 |
| CASE IH | 87441270 | A-87441270 |
| CASE IH | B506234 | A-B506234 |
| CASE IH | 86516699 | A-86516699 |
| CASE IH | 826761C1 | A-826761C1 |
| CASE IH | 830123C1 | A-830123C1 |
| CASE IH | 3136258R1 | A-3136258R1 |
| CASE IH | 171434C1 | A-171434C1 |
| CASE IH | 236161R2 | A-236161R2 |
| CASE IH | 830122C1 | A-830122C1 |
| CASE IH | 829921C1 | A-829921C1 |
| CASE IH | 6-1428 | A-6-1428 |
| CASE IH | 315969R1 | A-315969R1 |
| CASE IH | 352095C1 | A-352095C1 |
| CASE IH | 274705R1 | A-274705R1 |
| CASE IH | 401128R2 | A-401128R2 |
| CASE IH | 1607227C1 | A-1607227C1 |
| CASE IH | 530186R1 | A-530186R1 |
| CASE IH | 172230C1 | A-172230C1 |
| CASE IH | 171994C1 | A-171994C1 |
| CASE IH | 196370C1 | A-196370C1 |
| CASE IH | 656349R1 | A-656349R1 |
| CASE IH | 178763C1 | A-178763C1 |
| CASE IH | 187415C2 | A-187415C2 |
| CASE IH | 184796C1 | A-184796C1 |
| CASE IH | 666390R1 | A-666390R1 |



CASE IH

| OEM | OEM  Part No. | PIX  Part No. |
|---------|--|--|
| CASE IH | 550950R1 | A-550950R1 |
| CASE IH | 673685R1 | A-673685R1 |
| CASE IH | 552747R2 | A-552747R2 |
| CASE IH | 672974R2 | A-672974R2 |
| CASE IH | 665970R1 | A-665970R1 |
| CASE IH | 488082R2 | A-488082R2 |
| CASE IH | 413159A2 | A-413159A2 |
| CASE IH | 674620R1 | A-674620R1 |
| CASE IH | 1979149C1 | A-1979149C1 |
| CASE IH | 277448R1 | A-277448R1 |
| CASE IH | 243372A1 | A-243372A1 |
| CASE IH | A169970 | A-A169970 |
| CASE IH | 3055715R1 | A-3055715R1 |
| CASE IH | 4270717737 | A-4270717737 |
| CASE IH | H938752 | A-H938752 |
| CASE IH | 3143002 | A-3143002 |
| CASE IH | W938719 | A-W938719 |
| CASE IH | 3050382R1 | A-3050382R1 |
| CASE IH | 716404R1 | A-716404R1 |
| CASE IH | 3142286 | A-3142286 |
| CASE IH | 190003142290 | A-190003142290 |
| CASE IH | 190003142304 | A-190003142304 |
| CASE IH | 3142287 | A-3142287 |
| CASE IH | 1609B130009 | A-1609B130009 |
| CASE IH | M138747 | A-M138747 |
| CASE IH | 3068879R1 | A-3068879R1 |
| CASE IH | T38726 | A-T38726 |
| CASE IH | Q938736 | A-Q938736 |
| CASE IH | 303416R1 | A-303416R1 |
| CASE IH | 3136257R1 | A-3136257R1 |
| CASE IH | 1413C060017 | A-1413C060017 |
| CASE IH | 3060802R2 | A-3060802R2 |
| CASE IH | 3136663R1 | A-3136663R1 |
| CASE IH | 3055526R1 | A-3055526R1 |
| CASE IH | 3218802R1 | A-3218802R1 |
| CASE IH | S438718 | A-S438718 |
| CASE IH | MGP1112 | A-MGP1112 |
| CASE IH | 758866R1 | A-758866R1 |
| CASE IH | 712216R1 | A-712216R1 |
| CASE IH | 714241R1 | A-714241R1 |
| CASE IH | 764956R1 | A-764956R1 |
| CASE IH | K38718 | A-K38718 |
| CASE IH | 51651131427 | A-51651131427 |
| CASE IH | R138705 | A-R138705 |
| CASE IH | 51652131450 | A-51652131450 |
| CASE IH | 3171057R2 | A-3171057R2 |
| CASE IH | 9514310 | A-9514310 |



| OEM | OEM  Part No. | PIX  Part No. |
|---------|--|--|
| CASE IH | 51651132765 | A-51651132765 |
| CASE IH | 457643 | A-457643 |
| CASE IH | 89509459 | A-89509459 |
| CASE IH | 358213R1 | A-358213R1 |
| CASE IH | 756232R1 | A-756232R1 |
| CASE IH | 84024926 | A-84024926 |
| CASE IH | Q938713 | A-Q938713 |
| CASE IH | J38717 | A-J38717 |
| CASE IH | P138703 | A-P138703 |
| CASE IH | 51652171372 | A-51652171372 |
| CASE IH | G38715 | A-G38715 |
| CASE IH | 1979606C2 | A-1979606C2 |
| CASE IH | 3172232R1 | A-3172232R1 |
| CASE IH | B506236 | A-B506236 |
| CASE IH | 51651171700 | A-51651171700 |
| CASE IH | 61521R1 | A-61521R1 |
| CASE IH | B506238 | A-B506238 |
| CASE IH | 51651171930 | A-51651171930 |
| CASE IH | 3175457R1 | A-3175457R1 |
| CASE IH | 3781694 | A-3781694 |
| CASE IH | 89510091 | A-89510091 |
| CASE IH | 89507997 | A-89507997 |
| CASE IH | 89515713 | A-89515713 |
| CASE IH | 1145629 | A-01145629 |
| CASE IH | 80749145 | A-80749145 |
| CASE IH | B506239 | A-B506239 |
| CASE IH | 51651172413 | A-51651172413 |
| CASE IH | 3172404R1 | A-3172404R1 |
| CASE IH | 84045444 | A-84045444 |
| CASE IH | 419375000 | A-419375000 |
| CASE IH | B506237 | A-B506237 |
| CASE IH | Nd9674 | A-ND-9674 |
| CASE IH | 1407035R1 | A-1407035R1 |
| CASE IH | 3157739R1 | A-3157739R1 |
| CASE IH | 1408761R1 | A-1408761R1 |
| CASE IH | 51651173861 | A-51651173861 |
| CASE IH | 31275207N1 | A-31275207N1 |
| CASE IH | 89813594 | A-89813594 |
| CASE IH | 58622R1 | A-58622R1 |
| CASE IH | 80449701 | A-80449701 |
| CASE IH | 756237R1 | A-756237R1 |
| CASE IH | 769543R91 | A-769543R91 |
| CASE IH | 51651170965 | A-51651170965 |
| CASE IH | 51651170975 | A-51651170975 |
| CASE IH | 69490DA | A-69490DA |
| CASE IH | 662213R1 | A-662213R1 |
| CASE IH | 89515167 | A-89515167 |



CASE IH

| OEM | OEM  Part No. | PIX  Part No. |
|---------|--|--|
| CASE IH | 89515172 | A-89515172 |
| CASE IH | N38744 | A-N38744 |
| CASE IH | 80749144 | A-80749144 |
| CASE IH | K138722 | A-K138722 |
| CASE IH | L38742 | A-L38742 |
| CASE IH | P38745 | A-P38745 |
| CASE IH | 9837412 | A-9837412 |
| CASE IH | 51651221981 | A-51651221981 |
| CASE IH | 3167489R1 | A-3167489R1 |
| CASE IH | 80531558 | A-80531558 |
| CASE IH | 80727852 | A-80727852 |
| CASE IH | 9911860628 | A-9911860628 |
| CASE IH | 51651222413 | A-51651222413 |
| CASE IH | 178019R1 | A-178019R1 |
| CASE IH | 1970116C2 | A-1970116C2 |
| CASE IH | 4264715364 | A-4264715364 |
| CASE IH | 3167361R2 | A-3167361R2 |
| CASE IH | 51651222650 | A-51651222650 |
| CASE IH | 51651222800 | A-51651222800 |
| CASE IH | 616355 | A-616355 |
| CASE IH | 1410279R1 | A-1410279R1 |
| CASE IH | 9819676 | A-9819676 |
| CASE IH | 84045959 | A-84045959 |
| CASE IH | 3175336R1 | A-3175336R1 |
| CASE IH | 3170210R1 | A-3170210R1 |
| CASE IH | B506235 | A-B506235 |
| CASE IH | 769830R2 | A-769830R2 |
| CASE IH | 3795185 | A-3795185 |
| CASE IH | 3157994R1 | A-3157994R1 |
| CASE IH | 84045018 | A-84045018 |
| CASE IH | 51651223505 | A-51651223505 |
| CASE IH | 3173717R1 | A-3173717R1 |
| CASE IH | 89835010 | A-89835010 |
| CASE IH | 989271C1 | A-989271C1 |
| CASE IH | 98927C | A-98927C |
| CASE IH | 80746889 | A-80746889 |
| CASE IH | 3173164R1 | A-3173164R1 |
| CASE IH | 793417R2 | A-793417R2 |
| CASE IH | 182819C1 | A-182819C1 |
| CASE IH | 1325050C1 | A-1325050C1 |
| CASE IH | 3155178R1 | A-3155178R1 |
| CASE IH | 3167797R1 | A-3167797R1 |
| CASE IH | 9839375 | A-9839375 |
| CASE IH | 921330 | A-921330 |
| CASE IH | 9593418 | A-9593418 |
| CASE IH | 9593440 | A-9593440 |
| CASE IH | 84005971 | A-84005971 |



| OEM | OEM  Part No. | PIX  Part No. |
|---------|--|--|
| CASE IH | 89835047 | A-89835047 |
| CASE IH | 84005972 | A-84005972 |
| CASE IH | 84019385 | A-84019385 |
| CASE IH | 4221613143 | A-4221613143 |
| CASE IH | 3158455R1 | A-3158455R1 |
| CASE IH | 3173480R1 | A-3173480R1 |
| CASE IH | 3173115R1 | A-3173115R1 |
| CASE IH | 51651255246 | A-51651255246 |
| CASE IH | 51101256000 | A-51101256000 |
| CASE IH | 3175036R2 | A-3175036R2 |
| CASE IH | 793051R2 | A-793051R2 |
| CASE IH | 9502828 | A-9502828 |
| CASE IH | 9814069 | A-9814069 |
| CASE IH | 51652171800 | A-51652171800 |
| CASE IH | 51652172200 | A-51652172200 |
| CASE IH | 51652172500 | A-51652172500 |
| CASE IH | 770000722 | A-770000722 |
| CASE IH | 9351.0174.00 | A-9351.0174.00 |
| CASE IH | 4270722236 | A-4270722236 |
| CASE IH | 51652174225 | A-51652174225 |
| CASE IH | 51652174350 | A-51652174350 |
| CASE IH | 51652175000 | A-51652175000 |
| CASE IH | 89811480 | A-89811480 |
| CASE IH | 89819506 | A-89819506 |
| CASE IH | 89811963 | A-89811963 |
| CASE IH | 89819507 | A-89819507 |
| CASE IH | 904029 | A-904029 |
| CASE IH | 770002330 | A-770002330 |
| CASE IH | 904031 | A-904031 |
| CASE IH | 904038 | A-904038 |
| CASE IH | 904027 | A-904027 |
| CASE IH | 9351.0274.00 | A-9351.0274.00 |
| CASE IH | 3167149R1 | A-3167149R1 |
| CASE IH | 84007006 | A-84007006 |
| CASE IH | 1113096X1 | A-1113096X1 |
| CASE IH | 9835120 | A-9835120 |
| CASE IH | 84007677 | A-84007677 |
| CASE IH | 1410106R1 | A-1410106R1 |
| CASE IH | 1410462R1 | A-1410462R1 |
| CASE IH | 3157094R1 | A-3157094R1 |
| CASE IH | 3157738R2 | A-3157738R2 |
| CASE IH | 3157741R1 | A-3157741R1 |
| CASE IH | 797475 | A-797475 |
| CASE IH | 51653173180 | A-51653173180 |
| CASE IH | 31295188 | A-31295188 |
| CASE IH | 51653173762 | A-51653173762 |
| CASE IH | 3175078R1 | A-3175078R1 |



CASE IH

| OEM | OEM  Part No. | PIX  Part No. |
|---------|--|--|
| CASE IH | 3173726R1 | A-3173726R1 |
| CASE IH | 1113097C2 | A-1113097C2 |
| CASE IH | 80851792 | A-80851792 |
| CASE IH | 84814035 | A-84814035 |
| CASE IH | 80392361 | A-80392361 |
| CASE IH | 3167653R2 | A-3167653R2 |
| CASE IH | 84012390 | A-84012390 |
| CASE IH | 9593400 | A-9593400 |
| CASE IH | 4250121885 | A-4250121885 |
| CASE IH | 8602680 | A-8602680 |
| CASE IH | 87802822 | A-87802822 |
| CASE IH | 87441268 | A-87441268 |
| CASE IH | 87403145 | A-87403145 |
| CASE IH | 31314408 | A-31314408 |
| CASE IH | 87403144 | A-87403144 |
| CASE IH | 9835683 | A-9835683 |
| CASE IH | 84215838 | A-84215838 |
| CASE IH | 84075677 | A-84075677 |
| CASE IH | 716415R1 | A-716415R1 |
| CASE IH | 716417R1 | A-716417R1 |
| CASE IH | 89831693 | A-89831693 |
| CASE IH | 89831694 | A-89831694 |
| CASE IH | 89831696 | A-89831696 |
| CASE IH | 89831697 | A-89831697 |
| CASE IH | 89831698 | A-89831698 |
| CASE IH | 89831699 | A-89831699 |
| CASE IH | 89831700 | A-89831700 |
| CASE IH | 89831703 | A-89831703 |
| CASE IH | 89831705 | A-89831705 |
| CASE IH | 89831706 | A-89831706 |
| CASE IH | 89831707 | A-89831707 |
| CASE IH | 89831708 | A-89831708 |
| CASE IH | 89831709 | A-89831709 |
| CASE IH | 89831710 | A-89831710 |
| CASE IH | 89831711 | A-89831711 |
| CASE IH | 89831712 | A-89831712 |
| CASE IH | 89831713 | A-89831713 |
| CASE IH | 89831714 | A-89831714 |
| CASE IH | 89831715 | A-89831715 |
| CASE IH | 89831716 | A-89831716 |
| CASE IH | 89831717 | A-89831717 |
| CASE IH | 89831718 | A-89831718 |
| CASE IH | 89831719 | A-89831719 |
| CASE IH | 89831720 | A-89831720 |
| CASE IH | 89831721 | A-89831721 |
| CASE IH | 14010060002 | A-14010060002 |
| CASE IH | 299659A1 | A-299659A1 |



| OEM | OEM  Part No. | PIX  Part No. |
|---------|--|--|
| CASE IH | A938768 | A-A938768 |
| CASE IH | B938746 | A-B938746 |
| CASE IH | C338723 | A-C338723 |
| CASE IH | E84994 | A-E84994 |
| CASE IH | S938738 | A-S938738 |
| CASE IH | T938762 | A-T938762 |
| CASE IH | U938740 | A-U938740 |
| CASE IH | V938741 | A-V938741 |
| CASE IH | V938764 | A-V938764 |
| CASE IH | W938742 | A-W938742 |
| CASE IH | X938743 | A-X938743 |
| CASE IH | 80452023 | A-80452023 |
| CASE IH | 3228287R91 | A-3228287R91 |
| CASE IH | 130013 | A-130013 |
| CASE IH | 381236 | A-381236 |
| CASE IH | 748003 | A-748003 |
| CASE IH | 6500261 | A-6500261 |
| CASE IH | 9508557 | A-9508557 |
| CASE IH | 9835815 | A-9835815 |
| CASE IH | 87366024 | A-87366024 |
| CASE IH | 89831722 | A-89831722 |
| CASE IH | 89831723 | A-89831723 |
| CASE IH | 89831724 | A-89831724 |
| CASE IH | 89831725 | A-89831725 |
| CASE IH | 89831726 | A-89831726 |
| CASE IH | 89831727 | A-89831727 |
| CASE IH | 89831728 | A-89831728 |
| CASE IH | 89831730 | A-89831730 |
| CASE IH | 89831732 | A-89831732 |
| CASE IH | 89831734 | A-89831734 |
| CASE IH | 89831743 | A-89831743 |
| CASE IH | 89831744 | A-89831744 |
| CASE IH | 89831745 | A-89831745 |
| CASE IH | 89831746 | A-89831746 |
| CASE IH | 89831747 | A-89831747 |
| CASE IH | 89831748 | A-89831748 |
| CASE IH | 89831750 | A-89831750 |
| CASE IH | 89831751 | A-89831751 |
| CASE IH | 89831752 | A-89831752 |
| CASE IH | 082.383/28 | A-082.383/28 |
| CASE IH | 082.383/42 | A-082.383/42 |
| CASE IH | 162000060007(1) | A-162000060007(1) |
| CASE IH | 3043167R1 | A-3043167R1 |
| CASE IH | 3055715R91 | A-3055715R91 |
| CASE IH | 3068901R1 | A-3068901R1 |
| CASE IH | 3136421R1 | A-3136421R1 |
| CASE IH | 3139157R91 | A-3139157R91 |



CASE IH

| OEM | OEM  Part No. | PIX  Part No. |
|---------|--|--|
| CASE IH | 3144098R91 | A-3144098R91 |
| CASE IH | 3144678R1 | A-3144678R1 |
| CASE IH | 3218043R1 | A-3218043R1 |
| CASE IH | 3218951R1 | A-3218951R1 |
| CASE IH | 3228274R1 | A-3228274R1 |
| CASE IH | 3228282R1 | A-3228282R1 |
| CASE IH | 3228287R1 | A-3228287R1 |
| CASE IH | 3228641R1 | A-3228641R1 |
| CASE IH | 3522468M3 | A-3522468M3 |
| CASE IH | 6102366M1 | A-6102366M1 |
| CASE IH | 84766X1 | A-84766X1 |
| CASE IH | 3172275R1 | A-3172275R1 |
| CASE IH | 3176321R1 | A-3176321R1 |
| CASE IH | 1408840R1 | A-1408840R1 |
| CASE IH | 3158811R1 | A-3158811R1 |
| CASE IH | 3157600R1 | A-3157600R1 |
| CASE IH | 181055C11 | A-181055C11 |
| CASE IH | B506233 | A-B506233 |
| CASE IH | Q138796 | A-Q138796 |
| CASE IH | R138797 | A-R138797 |
| CASE IH | N938757 | A-N938757 |
| CASE IH | 9911861477 | A-9911861477 |
| CASE IH | 9911861918 | A-9911861918 |
| CASE IH | Nd9240 | A-ND9240 |
| CASE IH | 768220R91 | A-768220R91 |
| CASE IH | 767585R91 | A-767585R91 |
| CASE IH | R938760 | A-R938760 |
| CASE IH | C938770 | A-C938770 |
| CASE IH | Nd9036 | A-ND-9036 |
| CASE IH | 3175578R1 | A-3175578R1 |
| CASE IH | Nd9073 | A-ND-9073 |
| CASE IH | Nd9050 | A-ND9050 |
| CASE IH | Ap706228207 | A-AP706228207 |
| CASE IH | 3176558R1 | A-3176558R1 |
| CASE IH | 769482R1 | A-769482R1 |
| CASE IH | 9911861717 | A-9911861717 |
| CASE IH | 89515166 | A-89515166 |
| CASE IH | 209553078 | A-209553078 |
| CASE IH | 9911861493 | A-9911861493 |
| CASE IH | H938775 | A-H938775 |
| CASE IH | K938731 | A-K938731 |
| CASE IH | 80543226 | A-80543226 |
| CASE IH | 80565498 | A-80565498 |
| CASE IH | 89513440 | A-89513440 |
| CASE IH | 89850532 | A-89850532 |
| CASE IH | 9911861612 | A-9911861612 |
| CASE IH | ND9471 | A-ND-9471 |



| OEM | OEM  Part No. | PIX  Part No. |
|---------|--|--|
| CASE IH | Nd9359 | A-ND-9359 |
| CASE IH | Nd9092 | A-ND-9092 |
| CASE IH | 31360374 | A-31360374 |
| CASE IH | 9911861516 | A-9911861516 |
| CASE IH | 4131781578 | A-4131781578 |
| CASE IH | 9911861540 | A-9911861540 |
| CASE IH | 9911861862 | A-9911861862 |
| CASE IH | 9911861926 | A-9911861926 |
| CASE IH | 762861R1 | A-762861R1 |
| CASE IH | A138759 | A-A138759 |
| CASE IH | G138788 | A-G138788 |
| CASE IH | 31302068 | A-31302068 |
| CASE IH | 6100645M1 | A-6100645M1 |
| CASE IH | 288648A1 | A-288648A1 |
| CASE IH | 683548C91 | A-683548C91 |
| CASE IH | 760285R1 | A-760285R1 |
| CASE IH | 3061786R2 | A-3061786R2 |
| CASE IH | 80603720 | A-80603720 |
| CASE IH | 51651321480 | A-51651321480 |
| CASE IH | 3155068R1 | A-3155068R1 |
| CASE IH | 3156215R1 | A-3156215R1 |
| CASE IH | 3158242R1 | A-3158242R1 |
| CASE IH | 446969 | A-446969 |
| CASE IH | 80446969 | A-80446969 |
| CASE IH | 51651453200 | A-51651453200 |
| CASE IH | 314115 | A-314115 |
| CASE IH | 3175110R1 | A-3175110R1 |
| CASE IH | 51651502130 | A-51651502130 |
| CASE IH | 4270722244 | A-4270722244 |
| CASE IH | 244420A3 | A-244420A3 |
| CASE IH | 4254138496 | A-4254138496 |
| CASE IH | S938761 | A-S938761 |
| CASE IH | 1966513C1 | A-1966513C1 |
| CASE IH | 9833888 | A-9833888 |
| CASE IH | N938734 | A-N938734 |
| CASE IH | 4102/50063 | A-4102/50063 |
| CASE IH | A34359 | A-A34359 |
| CASE IH | 907190T1 | A-90-7190T1 |
| CASE IH | A75577 | A-A75577 |
| CASE IH | 903806T1 | A-90-3806T1 |
| CASE IH | A76758 | A-A76758 |
| CASE IH | 901375T1 | A-90-1375T1 |
| CASE IH | A138760 | A-A138760 |
| CASE IH | A164473 | A-A164473 |
| CASE IH | A164474 | A-A164474 |
| CASE IH | A65716 | A-A65716 |
| CASE-IH | 937806R1 | A-937806R1 |



CASE IH

| OEM | OEM  Part No. | PIX  Part No. |
|---------|--|--|
| CASE IH | A57123 | A-A57123 |
| CASE IH | 903861T1 | A-90-3861T1 |
| CASE IH | A57130 | A-A57130 |
| CASE IH | A76745 | A-A76745 |
| CASE IH | 903807T1 | A-90-3807T1 |
| CASE IH | 1285320C1 | A-1285320C1 |
| CASE IH | 1546117C2 | A-1546117C2 |
| CASE IH | 700707578 | A-700707578 |
| CASE IH | 1260258C2 | A-1260258C2 |
| CASE IH | 167031C2 | A-167031C2 |
| CASE IH | 131303C91 | A-131303C91 |
| CASE IH | 13988K | A-13988K |
| CASE IH | 161820C1 | A-161820C1 |
| CASE IH | 1315169C1 | A-1315169C1 |
| CASE IH | 165676C1 | A-165676C1 |
| CASE IH | 98041408 | A-98-041408 |
| CASE IH | 98028535 | A-98-028535 |
| CASE IH | 98029076 | A-98-029076 |
| CASE IH | 98031256 | A-98-031256 |
| CASE IH | 98039778 | A-98-039778 |
| CASE IH | 1113985 | A-1113985 |
| CASE IH | 10VX00C | A-10VX00C |
| CASE IH | 247426A1 | A-247426A1 |
| CASE IH | 98039776 | A-98-039776 |
| CASE IH | 84299873 | A-84299873 |
| CASE IH | 73180336 | A-73180336 |
| CASE IH | 84021589 | A-84021589 |
| CASE IH | 50404925 | A-50404925 |
| CASE IH | 87518813 | A-87518813 |
| CASE IH | 294462A1 | A-294462A1 |
| CASE IH | 87656225 | A-87656225 |
| CASE IH | 87641387 | A-87641387 |
| CASE IH | 84026762 | A-84026762 |
| CASE IH | 86514512 | A-86514512 |
| CASE IH | 87758085 | A-87758085 |
| CASE IH | 47406268 | A-47406268 |
| CASE IH | 84455765 | A-84455765 |
| CASE IH | 600P09 | A-600P09 |
| CASE IH | 600P05 | A-600P05 |
| CASE IH | 87739437 | A-87739437 |
| CASE IH | 86514520 | A-86514520 |
| CASE IH | 677419 | A-677419 |
| CASE IH | 87683178 | A-87683178 |
| CASE IH | 861731 | A-861731 |
| CASE IH | 87572660 | A-87572660 |
| CASE IH | 84056914 | A-84056914 |
| CASE IH | 84455758 | A-84455758 |



| OEM | OEM  Part No. | PIX  Part No. |
|---------|--|--|
| CASE IH | 84455766 | A-84455766 |
| CASE IH | 709998 | A-709998 |
| CASE IH | 904034 | A-904034 |
| CASE IH | 86629764 | A-86629764 |
| CASE IH | 84043107 | A-84043107 |
| CASE IH | 84057610 | A-84057610 |
| CASE IH | 84075053 | A-84075053 |
| CASE IH | 159837 | A-159837 |
| CASE IH | 84452723 | A-84452723 |
| CASE IH | 84452979 | A-84452979 |
| CASE IH | 80453267 | A-80453267 |
| CASE IH | 84180490 | A-84180490 |
| CASE IH | 516776 | A-516776 |
| CASE IH | 904035 | A-904035 |
| CASE IH | 47413433 | A-47413433 |
| CASE IH | 433747 | A-433747 |
| CASE IH | 80433747 | A-80433747 |
| CASE IH | 600J04 | A-600J04 |
| CASE IH | 600J06 | A-600J06 |
| CASE IH | 326298 | A-326298 |
| CASE IH | 600A10 | A-600A10 |
| CASE IH | 186347 | A-186347 |
| CASE IH | 84320459 | A-84320459 |
| CASE IH | 84226318 | A-84226318 |
| CASE IH | 47419045 | A-47419045 |
| CASE IH | 188213C3 | A-188213C3 |
| CASE IH | 600J09 | A-600J09 |
| CASE IH | 80347469 | A-80347469 |
| CASE IH | 84256364 | A-84256364 |
| CASE IH | 9351.0039.00 | A-9351.0039.00 |
| CASE IH | 87528805 | A-87528805 |
| CASE IH | 9351.0047.00 | A-9351.0047.00 |
| CASE IH | 600A12 | A-600A12 |
| CASE IH | 600A77 | A-600A77 |
| CASE IH | 9351.0055.00 | A-9351.0055.00 |
| CASE IH | 600A06 | A-600A06 |
| CASE IH | 600A715 | A-600A715 |
| CASE IH | 600A701 | A-600A701 |
| CASE IH | 84139175 | A-84139175 |
| CASE IH | 84411381 | A-84411381 |
| CASE IH | 84513766 | A-84513766 |
| CASE IH | 84284322 | A-84284322 |
| CASE IH | 8520042 | A-8520042 |
| CASE IH | 84376536 | A-84376536 |
| CASE IH | 904009 | A-904009 |
| CASE IH | 87564452 | A-87564452 |
| CASE IH | 87564549 | A-87564549 |



CASE IH

| OEM | OEM  Part No. | PIX  Part No. |
|---------|--|--|
| CASE IH | 84171789 | A-84171789 |
| CASE IH | 84256369 | A-84256369 |
| CASE IH | 904011 | A-904011 |
| CASE IH | 9351017400 | A-9351017400 |
| CASE IH | 717699 | A-717699 |
| CASE IH | 84311543 | A-84311543 |
| CASE IH | 84533502 | A-84533502 |
| CASE IH | 9351.0179.00 | A-9351.0179.00 |
| CASE IH | 84287970 | A-84287970 |
| CASE IH | 84381274 | A-84381274 |
| CASE IH | 84286835 | A-84286835 |
| CASE IH | 84284468 | A-84284468 |
| CASE IH | 87664231 | A-87664231 |
| CASE IH | 746894 | A-746894 |
| CASE IH | E020T12 | A-E020T12 |
| CASE IH | 1170140 | A-1170140 |
| CASE IH | 87671748 | A-87671748 |
| CASE IH | 1114576 | A-01114576 |
| CASE IH | 770001008 | A-770001008 |
| CASE IH | 1114568 | A-01114568 |
| CASE IH | 84191907 | A-84191907 |
| CASE IH | 84192753 | A-84192753 |
| CASE IH | 20471086 | A-20471086 |
| CASE IH | 767564R1 | A-767564R1 |
| CASE IH | 1113390 | A-1113390 |
| CASE IH | 1170044 | A-01170044 |
| CASE IH | 47439480 | A-47439480 |
| CASE IH | 84254495 | A-84254495 |
| CASE IH | 47434574 | A-47434574 |
| CASE IH | 84514757 | A-84514757 |
| CASE IH | 87491779 | A-87491779 |
| CASE IH | 84582506 | A-84582506 |
| CASE IH | 60203060 | A-060203060 |
| CASE IH | 47415905 | A-47415905 |
| CASE IH | 60186515 | A-060186515 |
| CASE IH | 20797305 | A-20797305 |
| CASE IH | 60038063 | A-60038063 |
| CASE IH | 60520763 | A-60520763 |
| CASE IH | 770000980 | A-770000980 |
| CASE IH | 84298887 | A-84298887 |
| CASE IH | 47441074 | A-47441074 |
| CASE IH | E040T09 | A-E040T09 |
| CASE IH | 84036578 | A-84036578 |
| CASE IH | 84017753 | A-84017753 |
| CASE IH | 1114295 | A-01114295 |
| CASE IH | 9911860958 | A-9911860958 |
| CASE IH | 86627809 | A-86627809 |



| OEM | OEM  Part No. | PIX  Part No. |
|---------|--|--|
| CASE IH | 1169428 | A-1169428 |
| CASE IH | 86627808 | A-86627808 |
| CASE IH | 84012562 | A-84012562 |
| CASE IH | 87030923 | A-87030923 |
| CASE IH | 87012453 | A-87012453 |
| CASE IH | 84262973 | A-84262973 |
| CASE IH | 1170028 | A-1170028 |
| CASE IH | 61063633 | A-061063633 |
| CASE IH | 84582509 | A-84582509 |
| CASE IH | 87671939 | A-87671939 |
| CASE IH | 84356659 | A-84356659 |
| CASE IH | 84127377 | A-84127377 |
| CASE IH | 84223612 | A-84223612 |
| CASE IH | 84518497 | A-84518497 |
| CASE IH | 84531713 | A-84531713 |
| CASE IH | 84305213 | A-84305213 |
| CASE IH | S619146 | A-S619146 |
| CASE IH | 20797483 | A-20797483 |
| CASE IH | 4221668181 | A-4221668181 |
| CASE IH | 20797491 | A-20797491 |
| CASE IH | 1112638 | A-1112638 |
| CASE IH | 851791 | A-851791 |
| CASE IH | 4990/20555 | A-4990/20555 |
| CASE IH | 72023391 | A-72023391 |
| CASE IH | 1170036 | A-1170036 |
| CASE IH | 1169983 | A-1169983 |
| CASE IH | 84148387 | A-84148387 |
| CASE IH | 47414501 | A-47414501 |
| CASE IH | 1113831 | A-1113831 |
| CASE IH | 84449233 | A-84449233 |
| CASE IH | 84511734 | A-84511734 |
| CASE IH | 84296393 | A-84296393 |
| CASE IH | 87656270 | A-87656270 |
| CASE IH | 1170204 | A-01170204 |
| CASE IH | 1170003 | A-1170003 |
| CASE IH | 72048753 | A-72048753 |
| CASE IH | 1170181 | A-01170181 |
| CASE IH | 84458482 | A-84458482 |
| CASE IH | 84397971 | A-84397971 |
| CASE IH | 87472997 | A-87472997 |
| CASE IH | 87705737 | A-87705737 |
| CASE IH | 84413724 | A-84413724 |
| CASE IH | 3288757 | A-3288757 |
| CASE IH | 3288768 | A-3288768 |
| CASE IH | 82989326 | A-82989326 |
| CASE IH | 84412878 | A-84412878 |
| CASE IH | 3288812 | A-3288812 |



CASE IH

| OEM | OEM  Part No. | PIX  Part No. |
|---------|--|--|
| CASE IH | 86982450 | A-86982450 |
| CASE IH | 87630521 | A-87630521 |
| CASE IH | 82989350 | A-82989350 |
| CASE IH | 3288922 | A-3288922 |
| CASE IH | 84127292 | A-84127292 |
| CASE IH | 3288999 | A-3288999 |
| CASE IH | 2855970 | A-2855970 |
| CASE IH | 3289078 | A-3289078 |
| CASE IH | 86974844 | A-86974844 |
| CASE IH | 3972386 | A-3972386 |
| CASE IH | 3289224 | A-3289224 |
| CASE IH | 3289279 | A-3289279 |
| CASE IH | 84590653 | A-84590653 |
| CASE IH | 873541380 | A-873541380 |
| CASE IH | 84346830 | A-84346830 |
| CASE IH | 3289481 | A-3289481 |
| CASE IH | 3289593 | A-3289593 |
| CASE IH | 3289604 | A-3289604 |
| CASE IH | 87519458 | A-87519458 |
| CASE IH | 3289648 | A-3289648 |
| CASE IH | 84257945 | A-84257945 |
| CASE IH | 87357455 | A-87357455 |
| CASE IH | 3288867 | A-3288867 |
| CASE IH | 3290158 | A-3290158 |
| CASE IH | 3289768 | A-3289768 |
| CASE IH | 84373502 | A-84373502 |
| CASE IH | 842373502 | A-842373502 |
| CASE IH | 835683 | A-835683 |
| CASE IH | 84423385 | A-84423385 |
| CASE IH | 504380539 | A-504380539 |
| CASE IH | 2976405 | A-2976405 |
| CASE IH | Br11018 | A-BR11018 |
| CASE IH | 219498 | A-219498 |
| CASE IH | 270174 | A-270174 |
| CASE IH | 142273 | A-142273 |
| CASE IH | 84457069 | A-84457069 |
| CASE IH | 875556830 | A-875556830 |
| CASE IH | 178623 | A-178623 |
| CASE IH | 51400100 | A-51400100 |
| CASE IH | 5095203 | A-5095203 |
| CASE IH | 80443635 | A-80443635 |
| CASE IH | 87643267 | A-87643267 |
| CASE IH | 5088081 | A-5088081 |
| CASE IH | 60010 | A-60010 |
| CASE IH | 600101 | A-600101 |
| CASE IH | 3140085 | A-3140085 |
| CASE IH | 600021 | A-600021 |



| OEM | OEM  Part No. | PIX  Part No. |
|---------|--|--|
| CASE IH | 21486 | A-21486 |
| CASE IH | 5186233 | A-5186233 |
| CASE IH | 84243629 | A-84243629 |
| CASE IH | 47408557 | A-47408557 |
| CASE IH | 2929681 | A-2929681 |
| CASE IH | 873735690 | A-873735690 |
| CASE IH | 602211 | A-602211 |
| CASE IH | 900611 | A-900611 |
| CASE IH | S80928 | A-S80928 |
| CASE IH | 3140058 | A-3140058 |
| CASE IH | 60518004 | A-060518004 |
| CASE IH | 3140109 | A-3140109 |
| CASE IH | 938787 | A-938787 |
| CASE IH | 84185053 | A-84185053 |
| CASE IH | 3140006 | A-3140006 |
| CASE IH | 87429954 | A-87429954 |
| CASE IH | 9508558 | A-9508558 |
| CASE IH | 444045 | A-444045 |
| CASE IH | 99466943 | A-99466943 |
| CASE IH | 99466947 | A-99466947 |
| CASE IH | 421173 | A-421173 |
| CASE IH | 84185033 | A-84185033 |
| CASE IH | 60517261 | A-60517261 |
| CASE IH | 60517253 | A-60517253 |
| CASE IH | 130071 | A-130071 |
| CASE IH | 3140053 | A-3140053 |
| CASE IH | 130012 | A-130012 |
| CASE IH | 84240788 | A-84240788 |
| CASE IH | 456216 | A-456216 |
| CASE IH | 1791046 | A-1791046 |
| CASE IH | 87526139 | A-87526139 |
| CASE IH | 87526140 | A-87526140 |
| CASE IH | 130072 | A-130072 |
| CASE IH | 1300721 | A-1300721 |
| CASE IH | 452022 | A-452022 |
| CASE IH | 80452022 | A-80452022 |
| CASE IH | 87671290 | A-87671290 |
| CASE IH | 87671291 | A-87671291 |
| CASE IH | 1301131 | A-1301131 |
| CASE IH | 399058 | A-399058 |
| CASE IH | 84286546 | A-84286546 |
| CASE IH | 87346859 | A-87346859 |
| CASE IH | 9850080 | A-9850080 |
| CASE IH | 9833619 | A-9833619 |
| CASE IH | 87374574 | A-87374574 |
| CASE IH | 3145900 | A-3145900 |
| CASE IH | 84271496 | A-84271496 |



CASE IH

| OEM | OEM  Part No. | PIX  Part No. |
|---------|--|--|
| CASE IH | 3142590 | A-3142590 |
| CASE IH | 379461A1 | A-379461A1 |
| CASE IH | 873541410 | A-873541410 |
| CASE IH | 84075683 | A-84075683 |
| CASE IH | 86634492 | A-86634492 |
| CASE IH | 84342685 | A-84342685 |
| CASE IH | 84342686 | A-84342686 |
| CASE IH | 446971 | A-446971 |
| CASE IH | 60121284 | A-60121284 |
| CASE IH | 244423A4 | A-244423A4 |
| CASE IH | 8403693 | A-8403693 |
| CASE IH | 8403632 | A-8403632 |
| CASE IH | 84074272 | A-84074272 |
| CASE IH | 159639A1 | A-159639A1 |
| CASE IH | 289199A1 | A-289199A1 |
| CASE IH | 289198A1 | A-289198A1 |
| CASE IH | 87456836 | A-87456836 |
| CASE IH | 2213342 | A-2213342 |
| CASE IH | 2929932 | A-2929932 |
| CASE IH | 3012326 | A-3012326 |
| CASE IH | 2900435 | A-2900435 |
| CASE IH | 2928981 | A-2928981 |
| CASE IH | 87528118 | A-87528118 |
| CASE IH | 84365709 | A-84365709 |
| CASE IH | 1966513C2 | A-1966513C2 |
| CASE IH | 190003140029 | A-190003140029 |
| CASE IH | 190003142357 | A-190003142357 |
| CASE IH | 1109080 | A-01109080 |
| CASE IH | 140100600021 | A-140100600021 |
| CASE IH | 190003140007 | A-190003140007 |
| CASE IH | 190003140032 | A-190003140032 |
| CASE IH | 130100600181 | A-130100600181 |
| CASE IH | 141100600141 | A-141100600141 |
| CASE IH | 190003140041 | A-190003140041 |
| CASE IH | 060506933 | A-060506933 |
| CASE IH | 190003142340 | A-190003142340 |
| CASE IH | 190003140013 | A-190003140013 |
| CASE IH | 98-045851 | A-98-045851 |
| CASE IH | 190003142358 | A-190003142358 |
| CASE IH | 190003142350 | A-190003142350 |
| CASE IH | 060038666 | A-060038666 |
| CASE IH | 190003140054 | A-190003140054 |
| CASE IH | 190003142278 | A-190003142278 |
| CASE IH | 190003142270 | A-190003142270 |
| CASE IH | 190003142272 | A-190003142272 |
| CASE IH | 190003142275 | A-190003142275 |
| CASE IH | 190003140030 | A-190003140030 |



| OEM | OEM  Part No. | PIX  Part No. |
|---------|--|--|
| CASE IH | 190003142273 | A-190003142273 |
| CASE IH | 190003140081 | A-190003140081 |
| CASE IH | 190003142532 | A-190003142532 |
| CASE IH | 3142541 | A-3142541 |
| CASE IH | 87304910 | A-87304910 |
| CASE IH | 190003142543 | A-190003142543 |
| CASE IH | 190003140037 | A-190003140037 |
| CASE IH | 190003142557 | A-190003142557 |
| CASE IH | 3142558 | A-3142558 |
| CASE IH | 190003142558 | A-190003142558 |
| CASE IH | 31400010 | A-31400010 |
| CASE IH | 139900270270 | A-139900270270 |
| CASE IH | 190003142503 | A-190003142503 |
| CASE IH | 190003142508 | A-190003142508 |
| CASE IH | 190003142526 | A-190003142526 |
| CASE IH | 190003142516 | A-190003142516 |
| CASE IH | 190003142527 | A-190003142527 |
| CASE IH | 190003142521 | A-190003142521 |
| CASE IH | 190003142504 | A-190003142504 |
| CASE IH | 700711062 | A-700711062 |
| CASE IH | 393271A1 | A-393271A1 |
| CASE IH | 90-8400T1 | A-90-8400T1 |
| CASE IH | 04-133180 | A-04-133180 |
| CASE IH | 98-039777 | A-98-039777 |
| CASE IH | 98-045896 | A-98-045896 |
| CASE IH | 1420001300041 | A-1420001300041 |
| CASE IH | 162000131001 | A-162000131001 |
| CASE IH | 190003140073 | A-190003140073 |
| CASE IH | 190003140064 | A-190003140064 |
| CASE IH | 190003140006 | A-190003140006 |
| CASE IH | 1301001300411 | A-1301001300411 |
| CASE IH | 130300600021 | A-130300600021 |
| CASE IH | 190003140083 | A-190003140083 |
| CASE IH | 01100788 | A-01100788 |
| CASE IH | 190003140047 | A-190003140047 |
| CASE IH | 190003140062 | A-190003140062 |
| CASE IH | 190003149999 | A-190003149999 |
| CASE IH | 01113928 | A-01113928 |
| CASE IH | 98-046005 | A-98-046005 |
| CASE IH | 190003142525 | A-190003142525 |
| CASE IH | 1320001300211 | A-1320001300211 |
| CASE IH | 1401001301321 | A-1401001301321 |
| CASE IH | 1420000600011 | A-1420000600011 |
| CASE IH | 1420000600111 | A-1420000600111 |
| CASE IH | 1399001300031 | A-1399001300031 |
| CASE IH | 190003140053 | A-190003140053 |
| CASE IH | 060191762 | A-060191762 |



CASE IH

| OEM | OEM  Part No. | PIX  Part No. |
|---------|--|--|
| CASE IH | 060500108 | A-060500108 |
| CASE IH | 1420000600121 | A-1420000600121 |
| CASE IH | 1620000600011 | A-1620000600011 |
| CASE IH | 1320000600121 | A-1320000600121 |
| CASE IH | 1620001300031 | A-1620001300031 |
| CASE IH | 060500116 | A-060500116 |
| CASE IH | 1374-310-418 | A-1374-310-418 |
| CASE IH | 98-042446 | A-98-042446 |
| CASE IH | 1401001301311 | A-1401001301311 |
| CASE IH | 190003140020 | A-190003140020 |
| CASE IH | 98-039925 | A-98-039925 |
| CASE IH | 139900270408 | A-139900270408 |
| CASE IH | ND-9003 | A-ND-9003 |
| CASE IH | ND-9317 | A-ND-9317 |
| CASE IH | 060067654 | A-060067654 |
| CASE IH | 01113897 | A-01113897 |
| CASE IH | 01111766 | A-01111766 |
| CASE IH | 01113872 | A-01113872 |
| CASE IH | 190003142590 | A-190003142590 |
| CASE IH | 01111067 | A-01111067 |
| CASE IH | 190003140039 | A-190003140039 |
| CASE IH | 1320001300201 | A-1320001300201 |
| CASE IH | 190003140035 | A-190003140035 |
| CASE IH | 190003140078 | A-190003140078 |
| CASE IH | 700715387 | A-700715387 |
| CASE IH | 700711883 | A-700711883 |
| CASE IH | 86514511 | A-86514511 |
| CASE IH | 610462R1 | A-610462R1 |
| CASE IH | 190003140084 | A-190003140084 |
| CASE IH | 190003142523 | A-190003142523 |
| CASE IH | 700709676 | A-700709676 |
| CASE IH | 542177R2 | A-542177R2 |
| CASE IH | 492102R1 | A-492102R1 |
| CASE IH | 824810C1 | A-824810C1 |
| CASE IH | 190003142710 | A-190003142710 |
| CASE IH | 190003142718 | A-190003142718 |
| CASE IH | 592128R1 | A-592128R1 |
| CASE IH | 181718C1 | A-181718C1 |
| CASE IH | 15166K | A-15166K |
| CASE IH | 824202C1 | A-824202C1 |
| CASE IH | 86517932 | A-86517932 |
| CASE IH | 580026R1 | A-580026R1 |
| CASE IH | 209002C1 | A-209002C1 |
| CASE IH | 824880C1 | A-824880C1 |
| CASE IH | 276565 | A-276565 |
| CASE IH | 824185C1 | A-824185C1 |
| CASE IH | 276799 | A-276799 |



| OEM | OEM  Part No. | PIX  Part No. |
|---------|--|--|
| CASE IH | 1103821 | A-01103821 |
| CASE IH | 98039691 | A-98-039691 |
| CASE IH | 1374310400 | A-1374-310-400 |
| CASE IH | 1104002 | A-01104002 |
| CASE IH | 1101723 | A-01101723 |
| CASE IH | 1113950 | A-01113950 |
| CASE IH | 21206287 | A-021206287 |
| CASE IH | 61015851 | A-061015851 |
| CASE IH | 4240053712 | A-4240053712 |
| CASE IH | 61068992 | A-061068992 |
| CASE IH | 3131095 | A-3131095 |
| CASE IH | 61068984 | A-061068984 |
| CASE IH | 1111661 | A-01111661 |
| CASE IH | 20476355 | A-020476355 |
| CASE IH | 61033443 | A-061033443 |
| CASE IH | 1113550 | A-01113550 |
| CASE IH | 1374310401 | A-1374-310-401 |
| CASE IH | 20953061 | A-020953061 |
| CASE IH | 1113864 | A-01113864 |
| CASE IH | 60007646 | A-060007646 |
| CASE IH | 60067646 | A-060067646 |
| CASE IH | 1111717 | A-01111717 |
| CASE IH | 1113880 | A-01113880 |
| CASE IH | 1112605 | A-01112605 |
| CASE IH | 1374390255 | A-1374-390-255 |
| CASE IH | 20953053 | A-020953053 |
| CASE IH | 1169694 | A-01169694 |
| CASE IH | 61069028 | A-061069028 |
| CASE IH | 190003140080 | A-190003140080 |
| CASE IH | 190003142802 | A-190003142802 |
| CASE IH | 824274C1 | A-824274C1 |
| CASE IH | 87655953 | A-87655953 |
| CASE IH | T32070 | A-T32070 |
| CASE IH | 567947R2 | A-567947R2 |
| CASE IH | 3103014R2 | A-3103014R2 |
| CASE IH | F11139 | A-F11139 |
| CASE IH | 87381877 | A-87381877 |
| CASE IH | 591878R1 | A-591878R1 |
| CASE IH | F7865 | A-F7865 |
| CASE IH | 174637C1 | A-174637C1 |
| CASE IH | 319905A1 | A-319905A1 |
| CASE IH | 86980546 | A-86980546 |
| CASE IH | 824881C1 | A-824881C1 |
| CASE IH | 1108473 | A-01108473 |
| CASE IH | 1169686 | A-01169686 |
| CASE IH | 1111887 | A-01111887 |
| CASE IH | 1374310425 | A-1374-310-425 |



CASE IH

| OEM | OEM  Part No. | PIX  Part No. |
|---------|--|--|
| CASE IH | 21189838 | A-021189838 |
| CASE IH | 60190786 | A-060190786 |
| CASE IH | 1111895 | A-01111895 |
| CASE IH | 1111227 | A-01111227 |
| CASE IH | 1112277 | A-01112277 |
| CASE IH | 60190778 | A-060190778 |
| CASE IH | 1109023 | A-01109023 |
| CASE IH | 3167361R1 | A-3167361R1 |
| CASE IH | 1374310403 | A-1374-310-403 |
| CASE IH | 1374390275 | A-1374-390-275 |
| CASE IH | 51200834 | A-51200834 |
| CASE IH | 217564C1 | A-217564C1 |
| CASE IH | 1265653C1 | A-1265653C1 |
| CASE IH | 98036261 | A-98-036261 |
| CASE IH | 98024334 | A-98-024334 |
| CASE IH | 700717131 | A-700717131 |
| CASE IH | 60178276 | A-060178276 |
| CASE IH | 60187276 | A-060187276 |
| CASE IH | 1113116 | A-01113116 |
| CASE IH | 1170132 | A-01170132 |
| CASE IH | 21365202 | A-021365202 |
| CASE IH | 1251214C1 | A-1251214C1 |
| CASE IH | 61068951 | A-061068951 |
| CASE IH | 11170198 | A-011170198 |
| CASE IH | 1374390129 | A-1374-390-129 |
| CASE IH | 99.0606631 | A-99.060663-1005 |
| CASE IH | T040H02A | A-T040H02-A |
| CASE IH | 181717C1 | A-181717C1 |
| CASE IH | 347157C1 | A-347157C1 |
| CASE IH | 1544594C2 | A-1544594C2 |
| CASE IH | N114635 | A-N114635 |
| CASE IH | 217702C1 | A-217702C1 |
| CASE IH | 1304061C2 | A-1304061C2 |
| CASE IH | 171146C1 | A-171146C1 |
| CASE IH | 217636C1 | A-217636C1 |
| CASE IH | 1418731R1 | A-1418731R1 |
| CASE IH | 599068R1 | A-599068R1 |
| CASE IH | 595921R1 | A-595921R1 |
| CASE IH | 169708C1 | A-169708C1 |
| CASE IH | 856419 | A-856419 |
| CASE IH | 3177182R1 | A-3177182R1 |
| CASE IH | 98039783 | A-98-039783 |
| CASE IH | 98026090 | A-98-026090 |
| CASE IH | 1374310407 | A-1374-310-407 |
| CASE IH | 98042220 | A-98-042220 |
| CASE IH | 98036087 | A-98-036087 |
| CASE IH | 98032070 | A-98-032070 |



| OEM | OEM  Part No. | PIX  Part No. |
|---------|--|--|
| CASE IH | 1374390157 | A-1374-390-157 |
| CASE IH | 99.0607383 | A-99.060738-3023 |
| CASE IH | 99.0607398 | A-99.060739-8023 |
| CASE IH | 98041788 | A-98-041788 |
| CASE IH | 1308489C1 | A-1308489C1 |
| CASE IH | 86976208 | A-86976208 |
| CASE IH | 3167653R1 | A-3167653R1 |
| CASE IH | 87594757 | A-87594757 |
| CASE IH | 1313095C1 | A-1313095C1 |
| CASE IH | 1313097C1 | A-1313097C1 |
| CASE IH | 1015993 | A-1015993 |
| CASE IH | 1015075 | A-1015075 |
| CASE IH | Fh855122 | A-FH855122 |
| CASE IH | 4113598 | A-04-113598 |
| CASE IH | 84262995 | A-84262995 |
| CASE IH | 4109135 | A-04-109135 |
| CASE IH | 4119434 | A-04-119434 |
| CASE IH | 86627797 | A-86627797 |
| CASE IH | 98027803 | A-98-027803 |
| CASE IH | 98039673 | A-98-039673 |
| CASE IH | 98043793 | A-98-043793 |
| CASE IH | 87548076 | A-87548076 |
| CASE IH | 87545997 | A-87545997 |
| CASE IH | 1416604R1 | A-1416604R1 |
| CASE IH | 1406929R1 | A-1406929R1 |
| CASE IH | 139900270478 | A-139900270478 |
| CASE IH | 4122838 | A-04-122838 |
| CASE IH | 4113518 | A-04-113518 |
| CASE IH | 4113516 | A-04-113516 |
| CASE IH | 908383T1 | A-90-8383T1 |
| CASE IH | 906850T1 | A-90-6850T1 |
| CASE IH | 700714140 | A-700714140 |
| CASE IH | 51200293 | A-51200293 |
| CASE IH | 1304181C1 | A-1304181C1 |
| CASE IH | 4114742 | A-04-114742 |
| CASE IH | 461312R1 | A-461312R1 |
| CASE IH | FAR8602680 | A-FAR8602680 |
| CASE IH | 907357T1 | A-90-7357T1 |
| CASE IH | T911557 | A-T911557 |
| CASE IH | 87423309 | A-87423309 |
| CASE IH | J935010 | A-J935010 |
| CASE IH | 87271895 | A-87271895 |
| CASE IH | A77959 | A-A77959 |
| CASE IH | 87398520 | A-87398520 |
| CASE IH | 190003142309 | A-190003142309 |
| CASE IH | 161200090098 | A-161200090098 |
| CASE IH | 190003140079 | A-190003140079 |



CASE IH

| OEM | OEM  Part No. | PIX  Part No. |
|---------|--|--|
| CASE IH | 190003141018 | A-190003141018 |
| CASE IH | 190003142313 | A-190003142313 |
| CASE IH | 190003142325 | A-190003142325 |
| CASE IH | 190003142334 | A-190003142334 |
| CASE IH | 139900270174 | A-139900270174 |
| CASE IH | 190003142284 | A-190003142284 |
| CASE IH | 190003142287 | A-190003142287 |
| CASE IH | 190003142293 | A-190003142293 |
| CASE IH | 3142280 | A-3142280 |
| CASE IH | 190003142291 | A-190003142291 |
| CASE IH | 190003142332 | A-190003142332 |
| CASE IH | 190003142295 | A-190003142295 |
| CASE IH | 190003143470 | A-190003143470 |
| CASE IH | 97-018167 | A-97-018167 |
| CASE IH | 70412C1 | A-70412C1 |
| CASE IH | 706556R2 | A-706556R2 |
| CASE IH | 711118R1 | A-711118R1 |
| CASE IH | 209038C1 | A-209038C1 |
| CASE IH | 599881R1 | A-599881R1 |
| CASE IH | 54857DB | A-54857DB |
| CASE IH | 38331K | A-38331K |
| CASE IH | 489399R1 | A-489399R1 |
| CASE IH | 492923R2 | A-492923R2 |
| CASE IH | 376370R1 | A-376370R1 |
| CASE IH | A22764 | A-A22764 |
| CASE IH | 87451034 | A-87451034 |
| CASE IH | 87755028 | A-87755028 |
| CASE IH | 61546 | A-6-1546 |
| CASE IH | K901111 | A-K901111 |
| CASE IH | 717356R91 | A-717356R91 |
| CASE IH | 3522485M3 | A-3522485M3 |
| CASE IH | D60572 | A-D60572 |
| CASE IH | D59867 | A-D59867 |
| CASE IH | A22765 | A-A22765 |
| CASE IH | 676622R1 | A-676622R1 |
| CASE IH | 596313R1 | A-596313R1 |
| CASE IH | 87715906 | A-87715906 |
| CASE IH | 87393292 | A-87393292 |
| CASE IH | 86989142 | A-86989142 |
| CASE IH | 87492321 | A-87492321 |
| CASE IH | R44131 | A-R44131 |
| CASE IH | 277546A1 | A-277546A1 |
| CASE IH | 51200857 | A-51200857 |
| CASE IH | L105654 | A-L105654 |
| CASE IH | 86514631 | A-86514631 |
| CASE IH | A135826 | A-A135826 |
| CASE IH | L50593 | A-L50593 |



| OEM | OEM  Part No. | PIX  Part No. |
|---------|--|--|
| CASE IH | 2852625 | A-2852625 |
| CASE IH | L57804 | A-L57804 |
| CASE IH | A22608 | A-A22608 |
| CASE IH | 86514609 | A-86514609 |
| CASE IH | 86514617 | A-86514617 |
| CASE IH | 3138935R1 | A-3138935R1 |
| CASE IH | A22763 | A-A22763 |
| CASE IH | D56917 | A-D56917 |
| CASE IH | 904664T1 | A-90-4664T1 |
| CASE IH | L57802 | A-L57802 |
| CASE IH | D60083 | A-D60083 |
| CASE IH | 1420001300051 | A-1420001300051 |
| CASE IH | 87608501 | A-87608501 |
| CASE IH | 1620000600061 | A-1620000600061 |
| CASE IH | 1620000600051 | A-1620000600051 |
| CASE IH | 1620000600071 | A-1620000600071 |
| CASE IH | 1620001300461 | A-1620001300461 |
| CASE IH | 1620001300041 | A-1620001300041 |
| CASE IH | 1620001300071 | A-1620001300071 |
| CASE IH | 1620001300741 | A-1620001300741 |
| CASE IH | A21457 | A-A21457 |
| CASE IH | D73446 | A-D73446 |
| CASE IH | 406097R1 | A-406097R1 |
| CASE IH | 75258258 | A-75258258 |
| CASE IH | 3159827R1 | A-3159827R1 |
| CASE IH | 700715435 | A-700715435 |
| CASE IH | 86401123 | A-86401123 |
| CASE IH | L112651 | A-L112651 |
| CASE IH | A139089 | A-A139089 |
| CASE IH | A11444 | A-A11444 |
| CASE IH | D127502 | A-D127502 |
| CASE IH | 217699C1 | A-217699C1 |
| CASE IH | 1958439C1 | A-1958439C1 |
| CASE IH | 72896C1 | A-72896C1 |
| CASE IH | 612460R1 | A-612460R1 |
| CASE IH | 553079R1 | A-553079R1 |
| CASE IH | 477179R1 | A-477179R1 |
| CASE IH | 203170C1 | A-203170C1 |
| CASE IH | 6135 | A-6-135 |
| CASE IH | 87608414 | A-87608414 |
| CASE IH | 345013R1 | A-345013R1 |
| CASE IH | 306658R1 | A-306658R1 |
| CASE IH | 203651C1 | A-203651C1 |
| CASE IH | 3170159R1 | A-3170159R1 |
| CASE IH | 662901R1 | A-662901R1 |
| CASE IH | 726285R1 | A-726285R1 |
| CASE IH | 1276634C1 | A-1276634C1 |



CASE IH

| OEM | OEM  Part No. | PIX  Part No. |
|---------|--|--|
| CASE IH | 588894R1 | A-588894R1 |
| CASE IH | 11466R | A-11466R |
| CASE IH | 610521C1 | A-610521C1 |
| CASE IH | 201092C1 | A-201092C1 |
| CASE IH | 829356C1 | A-829356C1 |
| CASE IH | 607666R1 | A-607666R1 |
| CASE IH | 3168669R1 | A-3168669R1 |
| CASE IH | 767587R1 | A-767587R1 |
| CASE IH | 665299R1 | A-665299R1 |
| CASE IH | 203644C1 | A-203644C1 |
| CASE IH | 553139R1 | A-553139R1 |
| CASE IH | 555350R2 | A-555350R2 |
| CASE IH | 16651K | A-16651K |
| CASE IH | 561133R2 | A-561133R2 |
| CASE IH | 57158 | A-57158 |
| CASE IH | 217703C1 | A-217703C1 |
| CASE IH | 135462C1 | A-135462C1 |
| CASE IH | 1315244C1 | A-1315244C1 |
| CASE IH | 595348R11 | A-595348R11 |
| CASE IH | 599428R1 | A-599428R1 |
| CASE IH | 1316575C2 | A-1316575C2 |
| CASE IH | 86514497 | A-86514497 |
| CASE IH | 86517915 | A-86517915 |
| CASE IH | 91572 | A-91572 |
| CASE IH | D41985600 | A-D41985600 |
| CASE IH | 599355R1 | A-599355R1 |
| CASE IH | 1101908 | A-01101908 |
| CASE IH | 3175432R1 | A-3175432R1 |
| CASE IH | 832077C1 | A-832077C1 |
| CASE IH | 596222R1 | A-596222R1 |
| CASE IH | 57604 | A-57604 |
| CASE IH | 3136251R1 | A-3136251R1 |
| CASE IH | 793094R1 | A-793094R1 |
| CASE IH | 793094R2 | A-793094R2 |
| CASE IH | 321565C1 | A-321565C1 |
| CASE IH | 668287R2 | A-668287R2 |
| CASE IH | 1253324C2 | A-1253324C2 |
| CASE IH | 607446R1 | A-607446R1 |
| CASE IH | 217698C1 | A-217698C1 |
| CASE IH | 1316574C2 | A-1316574C2 |
| CASE IH | 86509C2 | A-86509C2 |
| CASE IH | 87109130 | A-87109130 |
| CASE IH | 1866324R1 | A-1866324R1 |
| CASE IH | 217700C1 | A-217700C1 |
| CASE IH | 217701C1 | A-217701C1 |
| CASE IH | 3176489R1 | A-3176489R1 |
| CASE IH | 672178R1 | A-672178R1 |



| OEM | OEM  Part No. | PIX  Part No. |
|---------|--|--|
| CASE IH | 203658C1 | A-203658C1 |
| CASE IH | 672177R1 | A-672177R1 |
| CASE IH | 200380C1 | A-200380C1 |
| CASE IH | 200381C2 | A-200381C2 |
| CASE IH | 48042DB | A-48042DB |
| CASE IH | 832044C2 | A-832044C2 |
| CASE IH | 670282R1 | A-670282R1 |
| CASE IH | 667068R1 | A-667068R1 |
| CASE IH | 670144R1 | A-670144R1 |
| CASE IH | 3157738R1 | A-3157738R1 |
| CASE IH | 150816C1 | A-150816C1 |
| CASE IH | 543394R2 | A-543394R2 |
| CASE IH | 1960252C1 | A-1960252C1 |
| CASE IH | 592038R2 | A-592038R2 |
| CASE IH | 87710660 | A-87710660 |
| CASE IH | 89500400185 | A-89500400185 |
| CASE IH | 87710661 | A-87710661 |
| CASE IH | 87564117 | A-87564117 |
| CASE IH | Bn325050 | A-BN325050 |
| CASE IH | 87452843 | A-87452843 |
| CASE IH | 89500341808 | A-89500341808 |
| CASE IH | 902383T1 | A-902383T1 |
| CASE IH | 3911587 | A-3911587 |
| CASE IH | T911567 | A-T911567 |
| CASE IH | A78011 | A-A78011 |
| CASE IH | 56408 | A-56408 |
| CASE IH | 106465C1 | A-106465C1 |
| CASE IH | 87607871 | A-87607871 |
| CASE IH | 87733431 | A-87733431 |
| CASE IH | 492103R1 | A-492103R1 |
| CASE IH | F16447 | A-F16447 |
| CASE IH | 106492C1 | A-106492C1 |
| CASE IH | 555118R1 | A-555118R1 |
| CASE IH | 135594C1 | A-135594C1 |
| CASE IH | 565565R1 | A-565565R1 |
| CASE IH | 457191R2 | A-457191R2 |
| CASE IH | 726278R1 | A-726278R1 |
| CASE IH | 33504 | A-33504 |
| CASE IH | 555048R1 | A-555048R1 |
| CASE IH | 744477R1 | A-744477R1 |
| CASE IH | 1976277C1 | A-1976277C1 |
| CASE IH | 158797C1 | A-158797C1 |
| CASE IH | 562088R1 | A-562088R1 |
| CASE IH | 156445C1 | A-156445C1 |
| CASE IH | 87041779 | A-87041779 |
| CASE IH | 794484R1 | A-794484R1 |
| CASE IH | 87041778 | A-87041778 |

CASE IH



| OEM | OEM  Part No. | PIX  Part No. |
|---------|--|--|
| CASE IH | 3155177R1 | A-3155177R1 |
| CASE IH | 1408855R1 | A-1408855R1 |
| CASE IH | 1407324R1 | A-1407324R1 |
| CASE IH | 153301C1 | A-153301C1 |
| CASE IH | 793398R2 | A-793398R2 |
| CASE IH | 87041731 | A-87041731 |
| CASE IH | 203612C1 | A-203612C1 |
| CASE IH | 185712C1 | A-185712C1 |
| CASE IH | F20033 | A-F20033 |
| CASE IH | 607658R1 | A-607658R1 |
| CASE IH | 793417R1 | A-793417R1 |
| CASE IH | F19549 | A-F19549 |
| CASE IH | F9659 | A-F9659 |
| CASE IH | 1419233R1 | A-1419233R1 |
| CASE IH | M32813 | A-M32813 |
| CASE IH | 172373C1 | A-172373C1 |
| CASE IH | 591881R1 | A-591881R1 |
| CASE IH | 117004C1 | A-117004C1 |
| CASE IH | 793037R2 | A-793037R2 |
| CASE IH | 595621R1 | A-595621R1 |
| CASE IH | F12280 | A-F12280 |
| CASE IH | F14847 | A-F14847 |
| CASE IH | 210185C1 | A-210185C1 |
| CASE IH | 164999C2 | A-164999C2 |
| CASE IH | 55970 | A-55970 |
| CASE IH | 824961C1 | A-824961C1 |
| CASE IH | 189219C1 | A-189219C1 |
| CASE IH | 1374310379 | A-1374-310-379 |
| CASE IH | 1374310381 | A-1374-310-381 |
| CASE IH | 1374310420 | A-1374-310-420 |
| CASE IH | 69791 | A-69791 |
| CASE IH | F20032 | A-F20032 |
| CASE IH | 173109C1 | A-173109C1 |
| CASE IH | 3156216R1 | A-3156216R1 |
| CASE IH | F12604 | A-F12604 |
| CASE IH | F12258 | A-F12258 |
| CASE IH | F13212 | A-F13212 |
| CASE IH | D58998 | A-D58998 |
| CASE IH | 609998R1 | A-609998R1 |
| CASE IH | 1374310380 | A-1374-310-380 |
| CASE IH | 1415197R1 | A-1415197R1 |
| CASE IH | 1374310421 | A-1374-310-421 |
| CASE IH | 98029103 | A-98-029103 |
| CASE IH | 189662C3 | A-189662C3 |
| CASE IH | 3168030R2 | A-3168030R2 |
| CASE IH | 1302174C2 | A-1302174C2 |
| CASE IH | A189285 | A-A189285 |

| OEM | OEM  Part No. | PIX  Part No. |
|---------|--|--|
| CASE IH | 291019C2 | A-291019C2 |
| CASE IH | 907729T1 | A-90-7729T1 |
| CASE IH | 901502T1 | A-90-1502T1 |
| CASE IH | A189039 | A-A189039 |
| CASE IH | 16864 | A-1-6864 |
| CASE IH | 12228 | A-1-2228 |
| CASE IH | 403617R2 | A-403617R2 |
| CASE IH | 829920C1 | A-829920C1 |
| CASE IH | 379966R1 | A-379966R1 |
| CASE IH | 99.0602685 | A-99.060268-5000 |
| CASE IH | 700709214 | A-700709214 |
| CASE IH | 87499975 | A-87499975 |
| CASE IH | D43913 | A-D43913 |
| CASE IH | L51181 | A-L51181 |
| CASE IH | D47563 | A-D47563 |
| CASE IH | R30790 | A-R30790 |
| CASE IH | L71057 | A-L71057 |
| CASE IH | L110293 | A-L110293 |
| CASE IH | 240354R2 | A-240354R2 |
| CASE IH | R28518 | A-R28518 |
| CASE IH | L74972 | A-L74972 |
| CASE IH | R27266 | A-R27266 |
| CASE IH | A64206 | A-A64206 |
| CASE IH | A59296 | A-A59296 |
| CASE IH | 12059 | A-1-2059 |
| CASE IH | 179325C1 | A-179325C1 |
| CASE IH | 190779C1 | A-190779C1 |
| CASE IH | 1407123R | A-1407123R |
| CASE IH | 578096 | A-578096 |
| CASE IH | 1409652R1 | A-1409652R1 |
| CASE IH | 595137R1 | A-595137R1 |
| CASE IH | 3156220R92 | A-3156220R92 |
| CASE IH | F16080 | A-F16080 |
| CASE IH | 169719C1 | A-169719C1 |
| CASE IH | F9468 | A-F9468 |
| CASE IH | 592035R1 | A-592035R1 |
| CASE IH | 3168030R3 | A-3168030R3 |
| CASE IH | 87403165 | A-87403165 |
| CASE IH | 3218477R1 | A-3218477R1 |
| CASE IH | 440085A1 | A-440085A1 |
| CASE IH | D53495 | A-D53495 |
| CASE IH | 98046076 | A-98-046076 |
| CASE IH | 98046372 | A-98-046372 |
| CASE IH | 244423A5 | A-244423A5 |
| CASE IH | 84042180 | A-84042180 |
| CASE IH | 09802AB | A-09802AB |
| CASE IH | 739734R1 | A-739734R1 |



CASE IH



| OEM | OEM  Part No. | PIX  Part No. |
|---------|--|--|
| CASE IH | 247426A1 | A-247426A1 |
| CASE IH | 61068968 | A-61068968 |
| CASE IH | 60206971 | A-60206971 |
| CASE IH | 61069036 | A-61069036 |
| CASE IH | 184796C1 | A-184796C1 |
| CASE IH | 56408 | A-56408 |
| CASE IH | 16651K | A-16651K |
| CASE IH | 60206963 | A-60206963 |
| CASE IH | 191241 | A-191241 |
| CASE IH | 244420 | A-244420 |
| CASE IH | 244422 | A-244422 |
| CASE IH | 1330499 | A-1330499 |
| CASE IH | 1541702A | A-1541702A |
| CASE IH | 218509A1 | A-218509A1 |
| CASE IH | 228332A1 | A-228332A1 |
| CASE IH | 1313097C2 | A-1313097C2 |
| CASE IH | 84365262 | A-84365262 |
| CASE IH | 197414C1 | A-197414C1 |
| CASE IH | 9911861854 | A-9911861854 |
| CASE IH | 044000282 | A-044000282 |
| CASE IH | 47360559 | A-47360559 |
| CASE IH | 47455617 | A-47455617 |
| CASE IH | 47597575 | A-47597575 |
| CASE IH | 47616842 | A-47616842 |
| CASE IH | 1308489C2 | A-1308489C2 |
| CASE IH | 1541569C1 | A-1541569C1 |
| CASE IH | 191241C3 | A-191241C3 |
| CASE IH | 191290C1 | A-191290C1 |
| CASE IH | 194528C2 | A-194528C2 |
| CASE IH | 244420A1 | A-244420A1 |
| CASE IH | 413159A1 | A-413159A1 |
| CASE IH | 47360559 | A-47360559 |
| CASE IH | 47455617 | A-47455617 |
| CASE IH | 47597575 | A-47597575 |
| CASE IH | 47616842 | A-47616842 |
| CASE IH | 1308489C2 | A-1308489C2 |
| CASE IH | 1541569C1 | A-1541569C1 |
| CASE IH | 191241C3 | A-191241C3 |
| CASE IH | 191290C1 | A-191290C1 |
| CASE IH | 194528C2 | A-194528C2 |
| CASE IH | 244420A1 | A-244420A1 |
| CASE IH | 413159A1 | A-413159A1 |

CASE NEW HOLLAND (CNH)



| OEM | OEM  Part No. | PIX  Part No. |
|-----|--|--|
| CNH | 103579 | A-103579 |
| CNH | 106991C1 | A-106991C1 |
| CNH | 11113 | A-11113 |
| CNH | 1136712820 | A-1136712820 |
| CNH | 117120 | A-117120 |
| CNH | 1213572C1 | A-1213572C1 |
| CNH | 121960 | A-121960 |
| CNH | 121961 | A-121961 |
| CNH | 124572A1 | A-124572A1 |
| CNH | 127934 | A-127934 |
| CNH | 1288899C5 | A-1288899C5 |
| CNH | 1288900C3 | A-1288900C3 |
| CNH | 130100130041 | A-130100130041 |
| CNH | 130100130071 | A-130100130071 |
| CNH | 130100130072 | A-130100130072 |
| CNH | 130100130112 | A-130100130112 |
| CNH | 130100130113 | A-130100130113 |
| CNH | 130300060002 | A-130300060002 |
| CNH | 130800060010 | A-130800060010 |
| CNH | 1316573C1 | A-1316573C1 |
| CNH | 1316574C1 | A-1316574C1 |
| CNH | 131725 | A-131725 |
| CNH | 1319245C2 | A-1319245C2 |
| CNH | 132000060012 | A-132000060012 |
| CNH | 132000130020 | A-132000130020 |
| CNH | 1321564C1 | A-1321564C1 |
| CNH | 1321565C | A-1321565C |
| CNH | 132747 | A-132747 |
| CNH | 1330311C1 | A-1330311C1 |
| CNH | 133929 | A-133929 |
| CNH | 13394L | A-13394L |
| CNH | 13414 | A-13414 |
| CNH | 137203 | A-137203 |
| CNH | 1374-310-262 | A-1374-310-262 |
| CNH | 1374312041 | A-1374-312-041 |
| CNH | 139900270236 | A-139900270236 |
| CNH | 140100060002 | A-140100060002 |
| CNH | 140100130131 | A-140100130131 |
| CNH | 140876R1 | A-140876R1 |
| CNH | 1410106R1 | A-1410106R1 |
| CNH | 1410642R1 | A-1410642R1 |
| CNH | 1410655R1 | A-1410655R1 |
| CNH | 1410655R91 | A-1410655R91 |
| CNH | 1410692R1 | A-1410692R1 |
| CNH | 1410692R92 | A-1410692R92 |
| CNH | 1410935R1 | A-1410935R1 |
| CNH | 1410975R1 | A-1410975R1 |



CASE NEW HOLLAND (CNH)

| OEM | OEM  Part No. | PIX  Part No. |
|-----|--|--|
| CNH | 1411204R1 | A-1411204R1 |
| CNH | 1411205R1 | A-1411205R1 |
| CNH | 1413433R1 | A-1413433R1 |
| CNH | 1414584R1 | A-1414584R1 |
| CNH | 1414593R1 | A-1414593R1 |
| CNH | 1414856R91 | A-1414856R91 |
| CNH | 1415141R1 | A-1415141R1 |
| CNH | 1415149R1 | A-1415149R1 |
| CNH | 1415261R1 | A-1415261R1 |
| CNH | 1415360R1 | A-1415360R1 |
| CNH | 1415411R1 | A-1415411R1 |
| CNH | 1416434R1 | A-1416434R1 |
| CNH | 1416543R1 | A-1416543R1 |
| CNH | 1416594R1 | A-1416594R1 |
| CNH | 1416764R1 | A-1416764R1 |
| CNH | 1416852R1 | A-1416852R1 |
| CNH | 1417108R1 | A-1417108R1 |
| CNH | 141714R1 | A-141714R1 |
| CNH | 1417871R1 | A-1417871R1 |
| CNH | 1418296R1 | A-1418296R1 |
| CNH | 1418304R1 | A-1418304R1 |
| CNH | 1418394R1 | A-1418394R1 |
| CNH | 1418410R1 | A-1418410R1 |
| CNH | 1418692R1 | A-1418692R1 |
| CNH | 1419232R1 | A-1419232R1 |
| CNH | 1419381R1 | A-1419381R1 |
| CNH | 142000130004 | A-142000130004 |
| CNH | 142000130005 | A-142000130005 |
| CNH | 142975 | A-142975 |
| CNH | 142976 | A-142976 |
| CNH | 143313 | A-143313 |
| CNH | 1440692R92 | A-1440692R92 |
| CNH | 144313 | A-144313 |
| CNH | 144794 | A-144794 |
| CNH | 147849 | A-147849 |
| CNH | 150670C1 | A-150670C1 |
| CNH | 1537104C1 | A-1537104C1 |
| CNH | 156444C1 | A-156444C1 |
| CNH | 157024 | A-157024 |
| CNH | 159267C1 | A-159267C1 |
| CNH | 159588C1 | A-159588C1 |
| CNH | 161122C1 | A-161122C1 |
| CNH | 162000060001 | A-162000060001 |
| CNH | 162000060006 | A-162000060006 |
| CNH | 162000060007 | A-162000060007 |
| CNH | 162000130003 | A-162000130003 |
| CNH | 162000130007 | A-162000130007 |



| OEM | OEM  Part No. | PIX  Part No. |
|-----|--|--|
| CNH | 162000130046 | A-162000130046 |
| CNH | 162000130074 | A-162000130074 |
| CNH | 163152 | A-163152 |
| CNH | 163437 | A-163437 |
| CNH | 164528 | A-164528 |
| CNH | 164544 | A-164544 |
| CNH | 164899C2 | A-164899C2 |
| CNH | 164900C1 | A-164900C1 |
| CNH | 165419 | A-165419 |
| CNH | 166203 | A-166203 |
| CNH | 168080 | A-168080 |
| CNH | 168141 | A-168141 |
| CNH | 168347 | A-168347 |
| CNH | 175585C1 | A-175585C1 |
| CNH | 179317C1 | A-179317C1 |
| CNH | 179878 | A-179878 |
| CNH | 179944 | A-179944 |
| CNH | 179945 | A-179945 |
| CNH | 179946 | A-179946 |
| CNH | 1813095C1 | A-1813095C1 |
| CNH | 183039C1 | A-183039C1 |
| CNH | 184213 | A-184213 |
| CNH | 185471 | A-185471 |
| CNH | 185953 | A-185953 |
| CNH | 1863473 | A-1863473 |
| CNH | 188827 | A-188827 |
| CNH | 18884K | A-18884K |
| CNH | 191241C2 | A-191241C2 |
| CNH | 191288C2 | A-191288C2 |
| CNH | 192806C1 | A-192806C1 |
| CNH | 1954932C1 | A-1954932C1 |
| CNH | 1959837C1 | A-1959837C1 |
| CNH | 197413C1 | A-197413C1 |
| CNH | 197416C1 | A-197416C1 |
| CNH | 197480C1 | A-197480C1 |
| CNH | 197482C1 | A-197482C1 |
| CNH | 1976906C1 | A-1976906C1 |
| CNH | 1977190C1 | A-1977190C1 |
| CNH | 210629C1 | A-210629C1 |
| CNH | 214252 | A-214252 |
| CNH | 218131 | A-218131 |
| CNH | 219250 | A-219250 |
| CNH | 221458 | A-221458 |
| CNH | 224354 | A-224354 |
| CNH | 225915 | A-225915 |
| CNH | 226485 | A-226485 |
| CNH | 226487 | A-226487 |



CASE NEW HOLLAND (CNH)

| OEM | OEM  Part No. | PIX  Part No. |
|-----|--|--|
| CNH | 226488 | A-226488 |
| CNH | 227247 | A-227247 |
| CNH | 228316A1 | A-228316A1 |
| CNH | 228366 | A-228366 |
| CNH | 228673 | A-228673 |
| CNH | 229760 | A-229760 |
| CNH | 230037 | A-230037 |
| CNH | 230041 | A-230041 |
| CNH | 230043 | A-230043 |
| CNH | 230044 | A-230044 |
| CNH | 230046 | A-230046 |
| CNH | 230048 | A-230048 |
| CNH | 230051 | A-230051 |
| CNH | 230053 | A-230053 |
| CNH | 230054 | A-230054 |
| CNH | 230057 | A-230057 |
| CNH | 230059 | A-230059 |
| CNH | 230060 | A-230060 |
| CNH | 230061 | A-230061 |
| CNH | 230062 | A-230062 |
| CNH | 230064 | A-230064 |
| CNH | 23006A | A-23006A |
| CNH | 230073 | A-230073 |
| CNH | 230074 | A-230074 |
| CNH | 230075 | A-230075 |
| CNH | 230076 | A-230076 |
| CNH | 230079 | A-230079 |
| CNH | 230080 | A-230080 |
| CNH | 230101 | A-230101 |
| CNH | 230103 | A-230103 |
| CNH | 230108 | A-230108 |
| CNH | 230151 | A-230151 |
| CNH | 230153 | A-230153 |
| CNH | 230156 | A-230156 |
| CNH | 230172 | A-230172 |
| CNH | 230267 | A-230267 |
| CNH | 230360 | A-230360 |
| CNH | 231583 | A-231583 |
| CNH | 241895A2 | A-241895A2 |
| CNH | 242307 | A-242307 |
| CNH | 243332 | A-243332 |
| CNH | 244853 | A-244853 |
| CNH | 245213 | A-245213 |
| CNH | 246573 | A-246573 |
| CNH | 246773 | A-246773 |
| CNH | 247428A1 | A-247428A1 |
| CNH | 248265A2 | A-248265A2 |



| OEM | OEM  Part No. | PIX  Part No. |
|-----|--|--|
| CNH | 255402A1 | A-255402A1 |
| CNH | 258442 | A-258442 |
| CNH | 259289A1 | A-259289A1 |
| CNH | 263765 | A-263765 |
| CNH | 263766 | A-263766 |
| CNH | 266319 | A-266319 |
| CNH | 266408 | A-266408 |
| CNH | 271471 | A-271471 |
| CNH | 274223 | A-274223 |
| CNH | 275425 | A-275425 |
| CNH | 275426 | A-275426 |
| CNH | 275427 | A-275427 |
| CNH | 280108 | A-280108 |
| CNH | 283105 | A-283105 |
| CNH | 285236 | A-285236 |
| CNH | 2855568 | A-2855568 |
| CNH | 286497 | A-286497 |
| CNH | 288477 | A-288477 |
| CNH | 293956A1 | A-293956A1 |
| CNH | 301111A1 | A-301111A1 |
| CNH | 301525A1 | A-301525A1 |
| CNH | 3055261R1 | A-3055261R1 |
| CNH | 3055525R1 | A-3055525R1 |
| CNH | 309087 | A-309087 |
| CNH | 309364 | A-309364 |
| CNH | 3113342R1 | A-3113342R1 |
| CNH | 31208 | A-31208 |
| CNH | 312256A1 | A-312256A1 |
| CNH | 312258A1 | A-312258A1 |
| CNH | 312259A1 | A-312259A1 |
| CNH | 312630A1 | A-312630A1 |
| CNH | 31323185 | A-31323185 |
| CNH | 3167189R1 | A-3167189R1 |
| CNH | 320935 | A-320935 |
| CNH | 321582 | A-321582 |
| CNH | 321583 | A-321583 |
| CNH | 323413 | A-323413 |
| CNH | 324391 | A-324391 |
| CNH | 324791 | A-324791 |
| CNH | 326471 | A-326471 |
| CNH | 328424 | A-328424 |
| CNH | 3290 | A-3290 |
| CNH | 330198 | A-330198 |
| CNH | 330204 | A-330204 |
| CNH | 330441 | A-330441 |
| CNH | 333255 | A-333255 |
| CNH | 333347 | A-333347 |



CASE NEW HOLLAND (CNH)

| OEM | OEM  Part No. | PIX  Part No. |
|-----|--|--|
| CNH | 334065A | A-334065A |
| CNH | 335258 | A-335258 |
| CNH | 33552 | A-33552 |
| CNH | 336784 | A-336784 |
| CNH | 337415 | A-337415 |
| CNH | 337415A | A-337415A |
| CNH | 340433279 | A-340433279 |
| CNH | 350776 | A-350776 |
| CNH | 352219 | A-352219 |
| CNH | 353584 | A-353584 |
| CNH | 354115 | A-354115 |
| CNH | 356913 | A-356913 |
| CNH | 362499 | A-362499 |
| CNH | 362500 | A-362500 |
| CNH | 364033 | A-364033 |
| CNH | 364418 | A-364418 |
| CNH | 37004 | A-37004 |
| CNH | 375977 | A-375977 |
| CNH | 378672 | A-378672 |
| CNH | 381489 | A-381489 |
| CNH | 382228R2 | A-382228R2 |
| CNH | 384397 | A-384397 |
| CNH | 386155 | A-386155 |
| CNH | 387452 | A-387452 |
| CNH | 387454 | A-387454 |
| CNH | 387460 | A-387460 |
| CNH | 387469 | A-387469 |
| CNH | 387931 | A-387931 |
| CNH | 389069A1 | A-389069A1 |
| CNH | 389245 | A-389245 |
| CNH | 391143 | A-391143 |
| CNH | 391650 | A-391650 |
| CNH | 392134 | A-392134 |
| CNH | 392361 | A-392361 |
| CNH | 393326 | A-393326 |
| CNH | 394425 | A-394425 |
| CNH | 394426 | A-394426 |
| CNH | 395955 | A-395955 |
| CNH | 396543R1 | A-396543R1 |
| CNH | 396749 | A-396749 |
| CNH | 396750 | A-396750 |
| CNH | 397297 | A-397297 |
| CNH | 397297A | A-397297A |
| CNH | 397298 | A-397298 |
| CNH | 398622 | A-398622 |
| CNH | 401192R | A-401192R |
| CNH | 401192R1 | A-401192R1 |



| OEM | OEM  Part No. | PIX  Part No. |
|-----|--|--|
| CNH | 4015852 | A-4015852 |
| CNH | 402254R91 | A-402254R91 |
| CNH | 410896 | A-410896 |
| CNH | 411543 | A-411543 |
| CNH | 417643 | A-417643 |
| CNH | 42001 | A-42001 |
| CNH | 42002 | A-42002 |
| CNH | 420606 | A-420606 |
| CNH | 422281 | A-422281 |
| CNH | 422441 | A-422441 |
| CNH | 424318 | A-424318 |
| CNH | 427455 | A-427455 |
| CNH | 432642 | A-432642 |
| CNH | 432829 | A-432829 |
| CNH | 433639 | A-433639 |
| CNH | 4336392 | A-4336392 |
| CNH | 4337469 | A-4337469 |
| CNH | 4340200 | A-4340200 |
| CNH | 434045 | A-434045 |
| CNH | 434046 | A-434046 |
| CNH | 434047 | A-434047 |
| CNH | 439495 | A-439495 |
| CNH | 439832 | A-439832 |
| CNH | 443775 | A-443775 |
| CNH | 4456409 | A-4456409 |
| CNH | 446970A | A-446970A |
| CNH | 447041 | A-447041 |
| CNH | 4487947 | A-4487947 |
| CNH | 450552 | A-450552 |
| CNH | 451076 | A-451076 |
| CNH | 451481 | A-451481 |
| CNH | 452197R1 | A-452197R1 |
| CNH | 454990 | A-454990 |
| CNH | 4549901 | A-4549901 |
| CNH | 455865 | A-455865 |
| CNH | 4558657 | A-4558657 |
| CNH | 4582127 | A-4582127 |
| CNH | 4611312 | A-4611312 |
| CNH | 467261 | A-467261 |
| CNH | 467783 | A-467783 |
| CNH | 468291 | A-468291 |
| CNH | 468584 | A-468584 |
| CNH | 468759 | A-468759 |
| CNH | 4688853 | A-4688853 |
| CNH | 46914 | A-46914 |
| CNH | 4702438 | A-4702438 |
| CNH | 4712148 | A-4712148 |



CASE NEW HOLLAND (CNH)

| OEM | OEM  Part No. | PIX  Part No. |
|-----|--|--|
| CNH | 47135840 | A-47135840 |
| CNH | 47137503 | A-47137503 |
| CNH | 4716470 | A-4716470 |
| CNH | 4716471 | A-4716471 |
| CNH | 472177R1 | A-472177R1 |
| CNH | 4728940 | A-4728940 |
| CNH | 4736293 | A-4736293 |
| CNH | 4739709 | A-4739709 |
| CNH | 4745187 | A-4745187 |
| CNH | 47486558 | A-47486558 |
| CNH | 47486562 | A-47486562 |
| CNH | 47503515 | A-47503515 |
| CNH | 475694R1 | A-475694R1 |
| CNH | 475739R1 | A-475739R1 |
| CNH | 47608706 | A-47608706 |
| CNH | 47611637 | A-47611637 |
| CNH | 47611710 | A-47611710 |
| CNH | 47620157 | A-47620157 |
| CNH | 47620214 | A-47620214 |
| CNH | 47624033 | A-47624033 |
| CNH | 47636649 | A-47636649 |
| CNH | 477180R1 | A-477180R1 |
| CNH | 478263R91 | A-478263R91 |
| CNH | 47840644 | A-47840644 |
| CNH | 4796442 | A-4796442 |
| CNH | 4796652 | A-4796652 |
| CNH | 479898 | A-479898 |
| CNH | 4814275 | A-4814275 |
| CNH | 4816716 | A-4816716 |
| CNH | 4819722 | A-4819722 |
| CNH | 482222R2 | A-482222R2 |
| CNH | 482223R2 | A-482223R2 |
| CNH | 48224 | A-48224 |
| CNH | 4838527 | A-4838527 |
| CNH | 483878R1 | A-483878R1 |
| CNH | 4843796 | A-4843796 |
| CNH | 486543R3 | A-486543R3 |
| CNH | 487046R1 | A-487046R1 |
| CNH | 489608R91 | A-489608R91 |
| CNH | 495756R1 | A-495756R1 |
| CNH | 4975233 | A-4975233 |
| CNH | 500344766 | A-500344766 |
| CNH | 500386112 | A-500386112 |
| CNH | 501543 | A-501543 |
| CNH | 504145203 | A-504145203 |
| CNH | 51200826 | A-51200826 |
| CNH | 513220 | A-513220 |



| OEM | OEM  Part No. | PIX  Part No. |
|-----|--|--|
| CNH | 5140011 | A-5140011 |
| CNH | 5140012 | A-5140012 |
| CNH | 5140013 | A-5140013 |
| CNH | 5140014 | A-5140014 |
| CNH | 5140015 | A-5140015 |
| CNH | 518300 | A-518300 |
| CNH | 5186232 | A-5186232 |
| CNH | 529944 | A-529944 |
| CNH | 540547R1 | A-540547R1 |
| CNH | 540609R1 | A-540609R1 |
| CNH | 546372R1 | A-546372R1 |
| CNH | 546499R1 | A-546499R1 |
| CNH | 551911R1 | A-551911R1 |
| CNH | 553456R2 | A-553456R2 |
| CNH | 555045R1 | A-555045R1 |
| CNH | 56212 | A-56212 |
| CNH | 56213 | A-56213 |
| CNH | 56226 | A-56226 |
| CNH | 567451 | A-567451 |
| CNH | 571684 | A-571684 |
| CNH | 573286 | A-573286 |
| CNH | 573957 | A-573957 |
| CNH | 57471 | A-57471 |
| CNH | 575439 | A-575439 |
| CNH | 576135 | A-576135 |
| CNH | 576773 | A-576773 |
| CNH | 576776 | A-576776 |
| CNH | 577900 | A-577900 |
| CNH | 57902 | A-57902 |
| CNH | 57903 | A-57903 |
| CNH | 58532C1 | A-58532C1 |
| CNH | 590153 | A-590153 |
| CNH | 592712 | A-592712 |
| CNH | 593325 | A-593325 |
| CNH | 593648R2 | A-593648R2 |
| CNH | 593802R1 | A-593802R1 |
| CNH | 595185R21 | A-595185R21 |
| CNH | 598436 | A-598436 |
| CNH | 600A02 | A-600A02 |
| CNH | 601388 | A-601388 |
| CNH | 605529 | A-605529 |
| CNH | 605988 | A-605988 |
| CNH | 61320659 | A-61320659 |
| CNH | 614663R1 | A-614663R1 |
| CNH | 616004C1 | A-616004C1 |
| CNH | 616484 | A-616484 |
| CNH | 61-830 | A-61-830 |



CASE NEW HOLLAND (CNH)

| OEM | OEM  Part No. | PIX  Part No. |
|-----|--|--|
| CNH | 619657 | A-619657 |
| CNH | 620945 | A-620945 |
| CNH | 621024 | A-621024 |
| CNH | 6215233 | A-6215233 |
| CNH | 630406 | A-630406 |
| CNH | 63106 | A-63106 |
| CNH | 632243 | A-632243 |
| CNH | 632679 | A-632679 |
| CNH | 632889 | A-632889 |
| CNH | 633512 | A-633512 |
| CNH | 634069 | A-634069 |
| CNH | 634563 | A-634563 |
| CNH | 634564 | A-634564 |
| CNH | 635042 | A-635042 |
| CNH | 637782 | A-637782 |
| CNH | 63804 | A-63804 |
| CNH | 640091 | A-640091 |
| CNH | 640891 | A-640891 |
| CNH | 64212 | A-64212 |
| CNH | 64218 | A-64218 |
| CNH | 64234 | A-64234 |
| CNH | 642920 | A-642920 |
| CNH | 643076 | A-643076 |
| CNH | 643353 | A-643353 |
| CNH | 643574 | A-643574 |
| CNH | 648040 | A-648040 |
| CNH | 65306301 | A-65306301 |
| CNH | 65487 | A-65487 |
| CNH | 66351 | A-66351 |
| CNH | 66813 | A-66813 |
| CNH | 66869 | A-66869 |
| CNH | 668929R1 | A-668929R1 |
| CNH | 66973 | A-66973 |
| CNH | 673685RI | A-673685RI |
| CNH | 676620R1 | A-676620R1 |
| CNH | 679215 | A-679215 |
| CNH | 683846C1 | A-683846C1 |
| CNH | 694676 | A-694676 |
| CNH | 695648 | A-695648 |
| CNH | 696719 | A-696719 |
| CNH | 699351 | A-699351 |
| CNH | 700.055.627K | A-700.055.627K |
| CNH | 700052041 | A-700052041 |
| CNH | 700057604 | A-700057604 |
| CNH | 700705503 | A-700705503 |
| CNH | 700708836 | A-700708836 |
| CNH | 700708968 | A-700708968 |



| OEM | OEM  Part No. | PIX  Part No. |
|-----|--|--|
| CNH | 700709489 | A-700709489 |
| CNH | 700710289 | A-700710289 |
| CNH | 700714215 | A-700714215 |
| CNH | 700717699 | A-700717699 |
| CNH | 700717886 | A-700717886 |
| CNH | 700718206 | A-700718206 |
| CNH | 703274 | A-703274 |
| CNH | 705807 | A-705807 |
| CNH | 70663945 | A-70663945 |
| CNH | 708133 | A-708133 |
| CNH | 708177 | A-708177 |
| CNH | 708178 | A-708178 |
| CNH | 708712 | A-708712 |
| CNH | 709414 | A-709414 |
| CNH | 709502R1 | A-709502R1 |
| CNH | 709806 | A-709806 |
| CNH | 710754 | A-710754 |
| CNH | 711704 | A-711704 |
| CNH | 712320 | A-712320 |
| CNH | 713281 | A-713281 |
| CNH | 713902 | A-713902 |
| CNH | 71419256 | A-71419256 |
| CNH | 71460935 | A-71460935 |
| CNH | 71466146 | A-71466146 |
| CNH | 71470863 | A-71470863 |
| CNH | 71472992 | A-71472992 |
| CNH | 715130 | A-715130 |
| CNH | 715180 | A-715180 |
| CNH | 715782 | A-715782 |
| CNH | 716258 | A-716258 |
| CNH | 716415 | A-716415 |
| CNH | 717075 | A-717075 |
| CNH | 717399 | A-717399 |
| CNH | 719536 | A-719536 |
| CNH | 72106723 | A-72106723 |
| CNH | 72106738 | A-72106738 |
| CNH | 73075783 | A-73075783 |
| CNH | 73128581 | A-73128581 |
| CNH | 73148503 | A-73148503 |
| CNH | 73153341 | A-73153341 |
| CNH | 73157291 | A-73157291 |
| CNH | 73159031 | A-73159031 |
| CNH | 73162121 | A-73162121 |
| CNH | 7436771 | A-7436771 |
| CNH | 747403 | A-747403 |
| CNH | 748004 | A-748004 |
| CNH | 750045 | A-750045 |



CASE NEW HOLLAND (CNH)

| OEM | OEM  Part No. | PIX  Part No. |
|------------|---|---|
| CNH | 750166 | A-750166 |
| CNH | 7502685 | A-7502685 |
| CNH | 75250835 | A-75250835 |
| CNH | 75256773 | A-75256773 |
| CNH | 75257166 | A-75257166 |
| CNH | 75263885 | A-75263885 |
| CNH | 753063 | A-753063 |
| CNH | 75327255 | A-75327255 |
| CNH | 7542859 | A-7542859 |
| CNH | 7543887 | A-7543887 |
| CNH | 7543899 | A-7543899 |
| CNH | 754423 | A-754423 |
| CNH | 755778 | A-755778 |
| CNH | 75629 | A-75629 |
| CNH | 756971 | A-756971 |
| CNH | 757100 | A-757100 |
| CNH | 757725 | A-757725 |
| CNH | 758632 | A-758632 |
| CNH | 758728 | A-758728 |
| CNH | 76017908 | A-76017908 |
| CNH | 76040165 | A-76040165 |
| CNH | 76053579 | A-76053579 |
| CNH | 76073151 | A-76073151 |
| CNH | 76195548 | A-76195548 |
| CNH | 76195551 | A-76195551 |
| CNH | 76195553 | A-76195553 |
| CNH | 76195578 | A-76195578 |
| CNH | 76289 | A-76289 |
| CNH | 763952 | A-763952 |
| CNH | 76610068 | A-76610068 |
| CNH | 782170 | A-782170 |
| CNH | 783511 | A-783511 |
| CNH | 7855265 | A-7855265 |
| CNH | 7855745 | A-7855745 |
| CNH | 785734 | A-785734 |
| CNH | 786310 | A-786310 |
| CNH | 787800 | A-787800 |
| CNH | 79040265 | A-79040265 |
| CNH | 79097149 | A-79097149 |
| CNH | 793037R1 | A-793037R1 |
| CNH | 795008 | A-795008 |
| CNH | 79522R1 | A-79522R1 |
| CNH | 796624 | A-796624 |
| CNH | 79742C1 | A-79742C1 |
| CNH | 798132 | A-798132 |
| CNH | 80066870 | A-80066870 |
| CNH | 80138504 | A-80138504 |

| OEM | OEM  Part No. | PIX  Part No. |
|------------|---|---|
| CNH | 80226486 | A-80226486 |
| CNH | 80230029 | A-80230029 |
| CNH | 80230037 | A-80230037 |
| CNH | 80230038 | A-80230038 |
| CNH | 80230040 | A-80230040 |
| CNH | 80230044 | A-80230044 |
| CNH | 80230045 | A-80230045 |
| CNH | 80230046 | A-80230046 |
| CNH | 80230048 | A-80230048 |
| CNH | 80230049 | A-80230049 |
| CNH | 80230050 | A-80230050 |
| CNH | 80230051 | A-80230051 |
| CNH | 80230052 | A-80230052 |
| CNH | 80230053 | A-80230053 |
| CNH | 80230054 | A-80230054 |
| CNH | 80230061 | A-80230061 |
| CNH | 80230063 | A-80230063 |
| CNH | 80230064 | A-80230064 |
| CNH | 80230065 | A-80230065 |
| CNH | 80230066 | A-80230066 |
| CNH | 80230068 | A-80230068 |
| CNH | 80230069 | A-80230069 |
| CNH | 80230070 | A-80230070 |
| CNH | 80230071 | A-80230071 |
| CNH | 80230074 | A-80230074 |
| CNH | 80230075 | A-80230075 |
| CNH | 80230079 | A-80230079 |
| CNH | 80230101 | A-80230101 |
| CNH | 80230127 | A-80230127 |
| CNH | 80230131 | A-80230131 |
| CNH | 80230143 | A-80230143 |
| CNH | 80230154 | A-80230154 |
| CNH | 80230267 | A-80230267 |
| CNH | 80244025 | A-80244025 |
| CNH | 80246727 | A-80246727 |
| CNH | 80246978 | A-80246978 |
| CNH | 80246980 | A-80246980 |
| CNH | 80247782 | A-80247782 |
| CNH | 80248332 | A-80248332 |
| CNH | 80254093 | A-80254093 |
| CNH | 80259346 | A-80259346 |
| CNH | 80259477 | A-80259477 |
| CNH | 80261000 | A-80261000 |
| CNH | 80261001 | A-80261001 |
| CNH | 80264557 | A-80264557 |
| CNH | 80284521 | A-80284521 |
| CNH | 80309087 | A-80309087 |



CASE NEW HOLLAND (CNH)

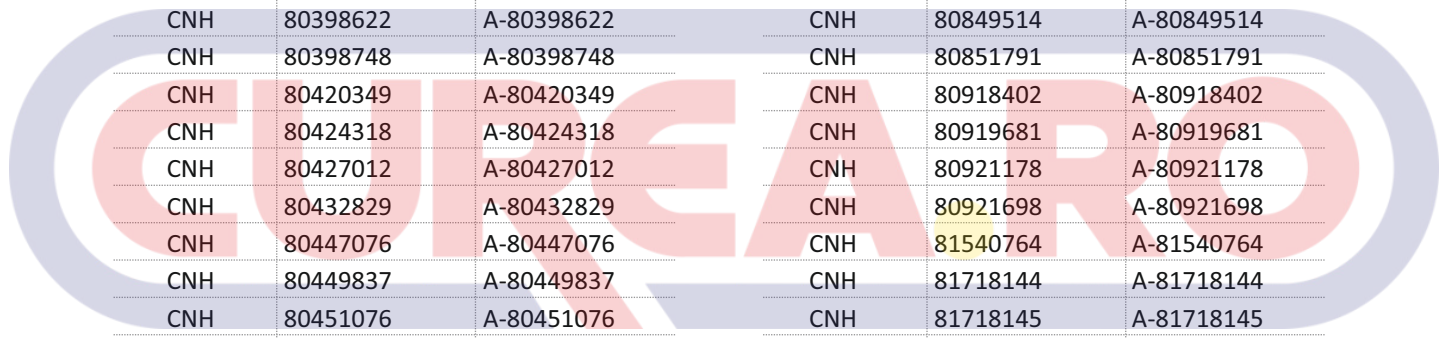

| OEM | OEM  Part No. | PIX  Part No. |
|------------|---|---|
| CNH | 80320059 | A-80320059 |
| CNH | 80326298 | A-80326298 |
| CNH | 80326954 | A-80326954 |
| CNH | 80327024 | A-80327024 |
| CNH | 80327040 | A-80327040 |
| CNH | 80327041 | A-80327041 |
| CNH | 80327062 | A-80327062 |
| CNH | 80328424 | A-80328424 |
| CNH | 80330204 | A-80330204 |
| CNH | 80331019 | A-80331019 |
| CNH | 80355797 | A-80355797 |
| CNH | 80362499 | A-80362499 |
| CNH | 80364418 | A-80364418 |
| CNH | 80367659 | A-80367659 |
| CNH | 80373401 | A-80373401 |
| CNH | 80387452 | A-80387452 |
| CNH | 80391142 | A-80391142 |
| CNH | 80392134 | A-80392134 |
| CNH | 80398622 | A-80398622 |
| CNH | 80398748 | A-80398748 |
| CNH | 80420349 | A-80420349 |
| CNH | 80424318 | A-80424318 |
| CNH | 80427012 | A-80427012 |
| CNH | 80432829 | A-80432829 |
| CNH | 80447076 | A-80447076 |
| CNH | 80449837 | A-80449837 |
| CNH | 80451076 | A-80451076 |
| CNH | 80455649 | A-80455649 |
| CNH | 80457309 | A-80457309 |
| CNH | 80570221 | A-80570221 |
| CNH | 80571926 | A-80571926 |
| CNH | 80576771 | A-80576771 |
| CNH | 80576772 | A-80576772 |
| CNH | 80576774 | A-80576774 |
| CNH | 80577900 | A-80577900 |
| CNH | 80579364 | A-80579364 |
| CNH | 80612305 | A-80612305 |
| CNH | 80614040 | A-80614040 |
| CNH | 80618040 | A-80618040 |
| CNH | 80619748 | A-80619748 |
| CNH | 80621104 | A-80621104 |
| CNH | 80694982 | A-80694982 |
| CNH | 80699268 | A-80699268 |
| CNH | 80703747 | A-80703747 |
| CNH | 80716253 | A-80716253 |
| CNH | 80716254 | A-80716254 |
| CNH | 80716414 | A-80716414 |

| OEM | OEM  Part No. | PIX  Part No. |
|------------|---|---|
| CNH | 80716416 | A-80716416 |
| CNH | 80717699 | A-80717699 |
| CNH | 80717700 | A-80717700 |
| CNH | 80746890 | A-80746890 |
| CNH | 80746893 | A-80746893 |
| CNH | 80746894 | A-80746894 |
| CNH | 80747177 | A-80747177 |
| CNH | 80748004 | A-80748004 |
| CNH | 80750045 | A-80750045 |
| CNH | 80750290 | A-80750290 |
| CNH | 80750318 | A-80750318 |
| CNH | 80751626 | A-80751626 |
| CNH | 80755808 | A-80755808 |
| CNH | 80773300 | A-80773300 |
| CNH | 80774747 | A-80774747 |
| CNH | 807852R1 | A-807852R1 |
| CNH | 80792809 | A-80792809 |
| CNH | 80796623 | A-80796623 |
| CNH | 80849514 | A-80849514 |
| CNH | 80851791 | A-80851791 |
| CNH | 80918402 | A-80918402 |
| CNH | 80919681 | A-80919681 |
| CNH | 80921178 | A-80921178 |
| CNH | 80921698 | A-80921698 |
| CNH | 81540764 | A-81540764 |
| CNH | 81718144 | A-81718144 |
| CNH | 81718145 | A-81718145 |
| CNH | 81718146 | A-81718146 |
| CNH | 81865046 | A-81865046 |
| CNH | 82007330 | A-82007330 |
| CNH | 82012177 | A-82012177 |
| CNH | 82021010 | A-82021010 |
| CNH | 822022 | A-822022 |
| CNH | 822427 | A-822427 |
| CNH | 822811R1 | A-822811R1 |
| CNH | 823233R1 | A-823233R1 |
| CNH | 823244R91 | A-823244R91 |
| CNH | 823244R92 | A-823244R92 |
| CNH | 823644 | A-823644 |
| CNH | 824175 | A-824175 |
| CNH | 824176 | A-824176 |
| CNH | 824182 | A-824182 |
| CNH | 824202R1 | A-824202R1 |
| CNH | 824516 | A-824516 |
| CNH | 824517 | A-824517 |
| CNH | 824801 | A-824801 |
| CNH | 825238 | A-825238 |







CASE NEW HOLLAND (CNH)

| OEM | OEM  Part No. | PIX  Part No. |
|-----|--|--|
| CNH | 825343 | A-825343 |
| CNH | 825399 | A-825399 |
| CNH | 825673R1 | A-825673R1 |
| CNH | 825942C1 | A-825942C1 |
| CNH | 826606R1 | A-826606R1 |
| CNH | 826675R1 | A-826675R1 |
| CNH | 826676R1 | A-826676R1 |
| CNH | 826677R1 | A-826677R1 |
| CNH | 826678R1 | A-826678R1 |
| CNH | 826705R1 | A-826705R1 |
| CNH | 826724R1 | A-826724R1 |
| CNH | 826725R1 | A-826725R1 |
| CNH | 826726R1 | A-826726R1 |
| CNH | 826727R1 | A-826727R1 |
| CNH | 826729R1 | A-826729R1 |
| CNH | 826730R1 | A-826730R1 |
| CNH | 826731R1 | A-826731R1 |
| CNH | 826732R1 | A-826732R1 |
| CNH | 826733R1 | A-826733R1 |
| CNH | 826734R1 | A-826734R1 |
| CNH | 826735R1 | A-826735R1 |
| CNH | 826736R1 | A-826736R1 |
| CNH | 826738R1 | A-826738R1 |
| CNH | 826740R1 | A-826740R1 |
| CNH | 826973R1 | A-826973R1 |
| CNH | 827339R2 | A-827339R2 |
| CNH | 827941R1 | A-827941R1 |
| CNH | 829499R1 | A-829499R1 |
| CNH | 829506R1 | A-829506R1 |
| CNH | 829537R1 | A-829537R1 |
| CNH | 829581R1 | A-829581R1 |
| CNH | 829598R1 | A-829598R1 |
| CNH | 82989064 | A-82989064 |
| CNH | 83910824 | A-83910824 |
| CNH | 84000189 | A-84000189 |
| CNH | 84000190 | A-84000190 |
| CNH | 84000191 | A-84000191 |
| CNH | 84002709 | A-84002709 |
| CNH | 84005357 | A-84005357 |
| CNH | 84012975 | A-84012975 |
| CNH | 84017742 | A-84017742 |
| CNH | 84018998 | A-84018998 |
| CNH | 84021488 | A-84021488 |
| CNH | 84021505 | A-84021505 |
| CNH | 84021588 | A-84021588 |
| CNH | 84021590 | A-84021590 |
| CNH | 84021863 | A-84021863 |



| OEM | OEM  Part No. | PIX  Part No. |
|-----|--|--|
| CNH | 84022215 | A-84022215 |
| CNH | 84022807 | A-84022807 |
| CNH | 84023912 | A-84023912 |
| CNH | 84026761 | A-84026761 |
| CNH | 84036579 | A-84036579 |
| CNH | 84037815 | A-84037815 |
| CNH | 84038109 | A-84038109 |
| CNH | 84043106 | A-84043106 |
| CNH | 84056995 | A-84056995 |
| CNH | 84057578 | A-84057578 |
| CNH | 84057609 | A-84057609 |
| CNH | 84058338 | A-84058338 |
| CNH | 84061953 | A-84061953 |
| CNH | 84064309 | A-84064309 |
| CNH | 84128638 | A-84128638 |
| CNH | 84128639 | A-84128639 |
| CNH | 84144544 | A-84144544 |
| CNH | 84175582 | A-84175582 |
| CNH | 84214719 | A-84214719 |
| CNH | 84214729 | A-84214729 |
| CNH | 84214730 | A-84214730 |
| CNH | 84214731 | A-84214731 |
| CNH | 84214733 | A-84214733 |
| CNH | 84214734 | A-84214734 |
| CNH | 84214735 | A-84214735 |
| CNH | 84214736 | A-84214736 |
| CNH | 84214737 | A-84214737 |
| CNH | 84214738 | A-84214738 |
| CNH | 84214739 | A-84214739 |
| CNH | 84214740 | A-84214740 |
| CNH | 84214741 | A-84214741 |
| CNH | 84214742 | A-84214742 |
| CNH | 84214743 | A-84214743 |
| CNH | 84214744 | A-84214744 |
| CNH | 84214745 | A-84214745 |
| CNH | 84214746 | A-84214746 |
| CNH | 84214747 | A-84214747 |
| CNH | 84214748 | A-84214748 |
| CNH | 84214749 | A-84214749 |
| CNH | 84222986 | A-84222986 |
| CNH | 84222987 | A-84222987 |
| CNH | 84222988 | A-84222988 |
| CNH | 84229205 | A-84229205 |
| CNH | 842516 | A-842516 |
| CNH | 84281470 | A-84281470 |
| CNH | 84345674 | A-84345674 |
| CNH | 84406044 | A-84406044 |



CASE NEW HOLLAND (CNH)

| OEM | OEM  Part No. | PIX  Part No. |
|-----|--|--|
| CNH | 84441893 | A-84441893 |
| CNH | 84447961 | A-84447961 |
| CNH | 84448591 | A-84448591 |
| CNH | 84449048 | A-84449048 |
| CNH | 84449765 | A-84449765 |
| CNH | 84464057 | A-84464057 |
| CNH | 84491659 | A-84491659 |
| CNH | 84492392 | A-84492392 |
| CNH | 84657C1 | A-84657C1 |
| CNH | 84766C1 | A-84766C1 |
| CNH | 84811C1 | A-84811C1 |
| CNH | 84817622 | A-84817622 |
| CNH | 84817628 | A-84817628 |
| CNH | 84817629 | A-84817629 |
| CNH | 84817630 | A-84817630 |
| CNH | 84817632 | A-84817632 |
| CNH | 84817633 | A-84817633 |
| CNH | 84817636 | A-84817636 |
| CNH | 84817639 | A-84817639 |
| CNH | 84817640 | A-84817640 |
| CNH | 84818387 | A-84818387 |
| CNH | 84818393 | A-84818393 |
| CNH | 84981372 | A-84981372 |
| CNH | 849888 | A-849888 |
| CNH | 84994983 | A-84994983 |
| CNH | 84994984 | A-84994984 |
| CNH | 84994987 | A-84994987 |
| CNH | 84995733 | A-84995733 |
| CNH | 84998862 | A-84998862 |
| CNH | 851123 | A-851123 |
| CNH | 855064 | A-855064 |
| CNH | 858900 | A-858900 |
| CNH | 86013676 | A-86013676 |
| CNH | 86502470 | A-86502470 |
| CNH | 86502471 | A-86502471 |
| CNH | 86510178 | A-86510178 |
| CNH | 86514496 | A-86514496 |
| CNH | 86514498 | A-86514498 |
| CNH | 86514499 | A-86514499 |
| CNH | 86514508 | A-86514508 |
| CNH | 86514514 | A-86514514 |
| CNH | 86514517 | A-86514517 |
| CNH | 86514518 | A-86514518 |
| CNH | 86514519 | A-86514519 |
| CNH | 86514522 | A-86514522 |
| CNH | 86514524 | A-86514524 |
| CNH | 86514525 | A-86514525 |

| OEM | OEM  Part No. | PIX  Part No. |
|-----|--|--|
| CNH | 86514527 | A-86514527 |
| CNH | 86514528 | A-86514528 |
| CNH | 86514529 | A-86514529 |
| CNH | 86514532 | A-86514532 |
| CNH | 86514535 | A-86514535 |
| CNH | 86514565 | A-86514565 |
| CNH | 86514566 | A-86514566 |
| CNH | 86514571 | A-86514571 |
| CNH | 86514588 | A-86514588 |
| CNH | 86514595 | A-86514595 |
| CNH | 86514597 | A-86514597 |
| CNH | 86514598 | A-86514598 |
| CNH | 86514599 | A-86514599 |
| CNH | 86514600 | A-86514600 |
| CNH | 86514603 | A-86514603 |
| CNH | 86514605 | A-86514605 |
| CNH | 86514607 | A-86514607 |
| CNH | 86514610 | A-86514610 |
| CNH | 86514613 | A-86514613 |
| CNH | 86514614 | A-86514614 |
| CNH | 86514618 | A-86514618 |
| CNH | 86514621 | A-86514621 |
| CNH | 86514623 | A-86514623 |
| CNH | 86514625 | A-86514625 |
| CNH | 86514629 | A-86514629 |
| CNH | 86514637 | A-86514637 |
| CNH | 86514639 | A-86514639 |
| CNH | 86514641 | A-86514641 |
| CNH | 86514988 | A-86514988 |
| CNH | 86514991 | A-86514991 |
| CNH | 86514994 | A-86514994 |
| CNH | 86514996 | A-86514996 |
| CNH | 86514997 | A-86514997 |
| CNH | 86516456 | A-86516456 |
| CNH | 86516668 | A-86516668 |
| CNH | 86517679 | A-86517679 |
| CNH | 86517684 | A-86517684 |
| CNH | 86517908 | A-86517908 |
| CNH | 86517911 | A-86517911 |
| CNH | 86517912 | A-86517912 |
| CNH | 86517914 | A-86517914 |
| CNH | 86517935 | A-86517935 |
| CNH | 86517939 | A-86517939 |
| CNH | 86517948 | A-86517948 |
| CNH | 86517953 | A-86517953 |
| CNH | 86518884 | A-86518884 |
| CNH | 86518885 | A-86518885 |



CASE NEW HOLLAND (CNH)

| OEM | OEM  Part No. | PIX  Part No. |
|-----|--|--|
| CNH | 8651887 | A-8651887 |
| CNH | 8651889 | A-8651889 |
| CNH | 86518901 | A-86518901 |
| CNH | 86518902 | A-86518902 |
| CNH | 86518903 | A-86518903 |
| CNH | 86518904 | A-86518904 |
| CNH | 86518906 | A-86518906 |
| CNH | 86518907 | A-86518907 |
| CNH | 86518910 | A-86518910 |
| CNH | 86518911 | A-86518911 |
| CNH | 86518912 | A-86518912 |
| CNH | 86518919 | A-86518919 |
| CNH | 86518922 | A-86518922 |
| CNH | 86518924 | A-86518924 |
| CNH | 86518941 | A-86518941 |
| CNH | 86520007 | A-86520007 |
| CNH | 86520008 | A-86520008 |
| CNH | 86527220 | A-86527220 |
| CNH | 86536809 | A-86536809 |
| CNH | 86556030 | A-86556030 |
| CNH | 86564289 | A-86564289 |
| CNH | 86565446 | A-86565446 |
| CNH | 86578110 | A-86578110 |
| CNH | 86584741 | A-86584741 |
| CNH | 86596697 | A-86596697 |
| CNH | 86627789 | A-86627789 |
| CNH | 86627792 | A-86627792 |
| CNH | 86627793 | A-86627793 |
| CNH | 86627794 | A-86627794 |
| CNH | 86627795 | A-86627795 |
| CNH | 86629763 | A-86629763 |
| CNH | 86629783 | A-86629783 |
| CNH | 86729096 | A-86729096 |
| CNH | 86837555 | A-86837555 |
| CNH | 87000216 | A-87000216 |
| CNH | 87020184 | A-87020184 |
| CNH | 87020285 | A-87020285 |
| CNH | 87020286 | A-87020286 |
| CNH | 87031438 | A-87031438 |
| CNH | 87031441 | A-87031441 |
| CNH | 87041732 | A-87041732 |
| CNH | 87053805 | A-87053805 |
| CNH | 87056837 | A-87056837 |
| CNH | 87301964 | A-87301964 |
| CNH | 87309962 | A-87309962 |
| CNH | 87309963 | A-87309963 |
| CNH | 87316555 | A-87316555 |

| OEM | OEM  Part No. | PIX  Part No. |
|-----|--|--|
| CNH | 87316556 | A-87316556 |
| CNH | 87323050 | A-87323050 |
| CNH | 87324567 | A-87324567 |
| CNH | 87344277 | A-87344277 |
| CNH | 87347456 | A-87347456 |
| CNH | 87349745 | A-87349745 |
| CNH | 87359824 | A-87359824 |
| CNH | 87374472 | A-87374472 |
| CNH | 87382455 | A-87382455 |
| CNH | 87427363 | A-87427363 |
| CNH | 87438128 | A-87438128 |
| CNH | 87454410 | A-87454410 |
| CNH | 87485645 | A-87485645 |
| CNH | 87492864 | A-87492864 |
| CNH | 87492866 | A-87492866 |
| CNH | 87492867 | A-87492867 |
| CNH | 87492869 | A-87492869 |
| CNH | 87492875 | A-87492875 |
| CNH | 87492876 | A-87492876 |
| CNH | 87492878 | A-87492878 |
| CNH | 87492881 | A-87492881 |
| CNH | 87492889 | A-87492889 |
| CNH | 87492892 | A-87492892 |
| CNH | 87492898 | A-87492898 |
| CNH | 87528620 | A-87528620 |
| CNH | 87535206 | A-87535206 |
| CNH | 87542623 | A-87542623 |
| CNH | 87546477 | A-87546477 |
| CNH | 87546926 | A-87546926 |
| CNH | 87559043 | A-87559043 |
| CNH | 87561763 | A-87561763 |
| CNH | 87566356 | A-87566356 |
| CNH | 87567251 | A-87567251 |
| CNH | 87590392 | A-87590392 |
| CNH | 87604563 | A-87604563 |
| CNH | 87605390 | A-87605390 |
| CNH | 87611875 | A-87611875 |
| CNH | 87615555 | A-87615555 |
| CNH | 87618427 | A-87618427 |
| CNH | 87646697 | A-87646697 |
| CNH | 87673681 | A-87673681 |
| CNH | 87681147 | A-87681147 |
| CNH | 87685981 | A-87685981 |
| CNH | 87697425 | A-87697425 |
| CNH | 87705866 | A-87705866 |
| CNH | 87709228 | A-87709228 |
| CNH | 87713059 | A-87713059 |



CASE NEW HOLLAND (CNH)

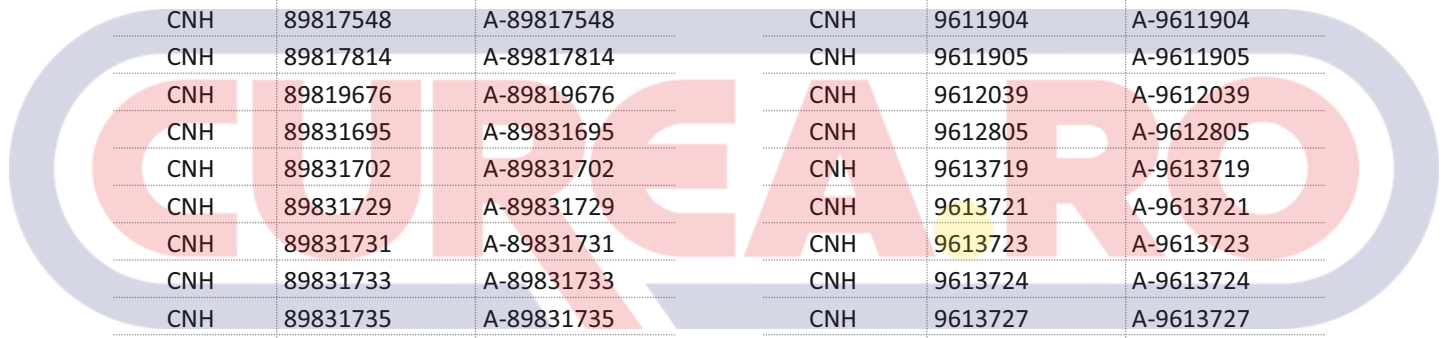

| OEM | OEM  Part No. | PIX  Part No. |
|-----|--|--|
| CNH | 87713097 | A-87713097 |
| CNH | 87743183 | A-87743183 |
| CNH | 87746757 | A-87746757 |
| CNH | 8818153 | A-8818153 |
| CNH | 8819672 | A-8819672 |
| CNH | 89434160 | A-89434160 |
| CNH | 89501863 | A-89501863 |
| CNH | 89504548 | A-89504548 |
| CNH | 89506463 | A-89506463 |
| CNH | 89513386 | A-89513386 |
| CNH | 89514989 | A-89514989 |
| CNH | 89514990 | A-89514990 |
| CNH | 89575153 | A-89575153 |
| CNH | 89811150 | A-89811150 |
| CNH | 89811151 | A-89811151 |
| CNH | 89815437 | A-89815437 |
| CNH | 89817250 | A-89817250 |
| CNH | 89817439 | A-89817439 |
| CNH | 89817548 | A-89817548 |
| CNH | 89817814 | A-89817814 |
| CNH | 89819676 | A-89819676 |
| CNH | 89831695 | A-89831695 |
| CNH | 89831702 | A-89831702 |
| CNH | 89831729 | A-89831729 |
| CNH | 89831731 | A-89831731 |
| CNH | 89831733 | A-89831733 |
| CNH | 89831735 | A-89831735 |
| CNH | 89831737 | A-89831737 |
| CNH | 89831740 | A-89831740 |
| CNH | 89831741 | A-89831741 |
| CNH | 89831742 | A-89831742 |
| CNH | 89835429 | A-89835429 |
| CNH | 89835815 | A-89835815 |
| CNH | 89842660 | A-89842660 |
| CNH | 89850782 | A-89850782 |
| CNH | 903650T1 | A-90-3650T1 |
| CNH | 905529 | A-905529 |
| CNH | 9131519 | A-9131519 |
| CNH | 9131533 | A-9131533 |
| CNH | 919681 | A-919681 |
| CNH | 920012988 | A-920012988 |
| CNH | 920016253 | A-920016253 |
| CNH | 920016255 | A-920016255 |
| CNH | 920018706 | A-920018706 |
| CNH | 920018888 | A-920018888 |
| CNH | 920018889 | A-920018889 |
| CNH | 920019295 | A-920019295 |

| OEM | OEM  Part No. | PIX  Part No. |
|-----|--|--|
| CNH | 920019497 | A-920019497 |
| CNH | 920019570 | A-920019570 |
| CNH | 920019588 | A-920019588 |
| CNH | 922872 | A-922872 |
| CNH | 9228728 | A-9228728 |
| CNH | 9230191 | A-9230191 |
| CNH | 935951R1 | A-935951R1 |
| CNH | 942231C1 | A-942231C1 |
| CNH | 944028926 | A-944028926 |
| CNH | 944032610 | A-944032610 |
| CNH | 95011824 | A-95011824 |
| CNH | 953962C2 | A-953962C2 |
| CNH | 9579546 | A-9579546 |
| CNH | 9600753 | A-9600753 |
| CNH | 9601139 | A-9601139 |
| CNH | 9601666.00 | A-9601666 |
| CNH | 9601699 | A-9601699 |
| CNH | 9607568 | A-9607568 |
| CNH | 9611904 | A-9611904 |
| CNH | 9611905 | A-9611905 |
| CNH | 9612039 | A-9612039 |
| CNH | 9612805 | A-9612805 |
| CNH | 9613719 | A-9613719 |
| CNH | 9613721 | A-9613721 |
| CNH | 9613723 | A-9613723 |
| CNH | 9613724 | A-9613724 |
| CNH | 9613727 | A-9613727 |
| CNH | 9613728 | A-9613728 |
| CNH | 9616745 | A-9616745 |
| CNH | 9622032 | A-9622032 |
| CNH | 9624507 | A-9624507 |
| CNH | 9625879 | A-9625879 |
| CNH | 9636395 | A-9636395 |
| CNH | 9636667 | A-9636667 |
| CNH | 9637348 | A-9637348 |
| CNH | 9671704 | A-9671704 |
| CNH | 9672186 | A-9672186 |
| CNH | 9672187 | A-9672187 |
| CNH | 9672189 | A-9672189 |
| CNH | 9672190 | A-9672190 |
| CNH | 9672191 | A-9672191 |
| CNH | 9672193 | A-9672193 |
| CNH | 9672194 | A-9672194 |
| CNH | 9672207 | A-9672207 |
| CNH | 9672208 | A-9672208 |
| CNH | 9672210 | A-9672210 |
| CNH | 9672211 | A-9672211 |



CASE NEW HOLLAND (CNH)

| OEM | OEM  Part No. | PIX  Part No. |
|-----|--|--|
| CNH | 9672212 | A-9672212 |
| CNH | 9672216 | A-9672216 |
| CNH | 9672221 | A-9672221 |
| CNH | 9707244 | A-9707244 |
| CNH | 9807449 | A-9807449 |
| CNH | 9811479 | A-9811479 |
| CNH | 9811480 | A-9811480 |
| CNH | 9817249 | A-9817249 |
| CNH | 9820480 | A-9820480 |
| CNH | 9828695 | A-9828695 |
| CNH | 9829167 | A-9829167 |
| CNH | 9831515 | A-9831515 |
| CNH | 9838606 | A-9838606 |
| CNH | 98408533 | A-98408533 |
| CNH | 98424142 | A-98424142 |
| CNH | 9842808 | A-9842808 |
| CNH | 98433148 | A-98433148 |
| CNH | 98454854 | A-98454854 |
| CNH | 98454857 | A-98454857 |
| CNH | 98454864 | A-98454864 |
| CNH | 9845513 | A-9845513 |
| CNH | 98465813 | A-98465813 |
| CNH | 98473706 | A-98473706 |
| CNH | 98473747 | A-98473747 |
| CNH | 98473922 | A-98473922 |
| CNH | 98490936 | A-98490936 |
| CNH | 9849524 | A-9849524 |
| CNH | 9850321 | A-9850321 |
| CNH | 9850782 | A-9850782 |
| CNH | 990606631005 | A-990606631005 |
| CNH | 990607383023 | A-990607383023 |
| CNH | 990607398023 | A-990607398023 |
| CNH | 99439812 | A-99439812 |
| CNH | A26660 | A-A26660 |
| CNH | A38824 | A-A38824 |
| CNH | AUB161355 | A-AUB161355 |
| CNH | C22707 | A-C22707 |
| CNH | C25686 | A-C25686 |
| CNH | CUR825343 | A-CUR825343 |
| CNH | D129916 | A-D129916 |
| CNH | D2NN8620A | A-D2NN8620A |
| CNH | D3NN8620B | A-D3NN8620B |
| CNH | D6NN8260A | A-D6NN8260A |
| CNH | D6NN8620B | A-D6NN8620B |
| CNH | D80856 | A-D80856 |
| CNH | D80857 | A-D80857 |
| CNH | DF069791 | A-DF069791 |

| OEM | OEM  Part No. | PIX  Part No. |
|-----|--|--|
| CNH | DF070542 | A-DF070542 |
| CNH | DF091572 | A-DF091572 |
| CNH | E62228 | A-E62228 |
| CNH | E7NN10C318AA | A-E7NN10C318AA |
| CNH | F10280 | A-F10280 |
| CNH | F13541 | A-F13541 |
| CNH | F13799 | A-F13799 |
| CNH | F13800 | A-F13800 |
| CNH | F14857 | A-F14857 |
| CNH | F16745 | A-F16745 |
| CNH | F16867 | A-F16867 |
| CNH | F17082 | A-F17082 |
| CNH | F17445 | A-F17445 |
| CNH | F17460 | A-F17460 |
| CNH | F18303 | A-F18303 |
| CNH | F18661 | A-F18661 |
| CNH | F18662 | A-F18662 |
| CNH | F19498 | A-F19498 |
| CNH | F19939 | A-F19939 |
| CNH | F20061 | A-F20061 |
| CNH | F20854 | A-F20854 |
| CNH | F21990 | A-F21990 |
| CNH | F22398 | A-F22398 |
| CNH | F22765 | A-F22765 |
| CNH | F22821 | A-F22821 |
| CNH | F23028 | A-F23028 |
| CNH | F7868 | A-F7868 |
| CNH | F8047 | A-F8047 |
| CNH | F9587 | A-F9587 |
| CNH | F9935 | A-F9935 |
| CNH | Fh056325 | A-FH056325 |
| CNH | G46083 | A-G46083 |
| CNH | G46234 | A-G46234 |
| CNH | Gi576772 | A-GI576772 |
| CNH | H429357 | A-H429357 |
| CNH | H437092 | A-H437092 |
| CNH | H438262 | A-H438262 |
| CNH | J903090 | A-J903090 |
| CNH | J911558 | A-J911558 |
| CNH | J911568 | A-J911568 |
| CNH | J911569 | A-J911569 |
| CNH | J911570 | A-J911570 |
| CNH | J911575 | A-J911575 |
| CNH | J911577 | A-J911577 |
| CNH | J911578 | A-J911578 |
| CNH | J911584 | A-J911584 |
| CNH | J911671 | D-J911671 |



CASE NEW HOLLAND (CNH)



| OEM | OEM Part No. | PIX Part No. |
|-----|--------------|----------------|
| CNH | J921603 | A-J921603 |
| CNH | K306655 | A-K306655 |
| CNH | K307429 | A-K307429 |
| CNH | K952514 | A-K952514 |
| CNH | L11111 | A-L11111 |
| CNH | L11705 | A-L11705 |
| CNH | L49006 | A-L49006 |
| CNH | MA-42292 | A-MA-42292 |
| CNH | MH014386 | A-MH014386 |
| CNH | S202900 | A-S202900 |
| CNH | VA0591042054 | A-VA0591042054 |
| CNH | VA3134812101 | A-VA3134812101 |
| CNH | VA3434904400 | A-VA3434904400 |
| CNH | VI1136712820 | A-VI1136712820 |
| CNH | VI1136712830 | A-VI1136712830 |
| CNH | VI8972322520 | A-VI8972322520 |
| CNH | YN20M01282D2 | A-YN20M01282D2 |
| CNH | YN20M01282D4 | A-YN20M01282D4 |
| CNH | YN20M01414D2 | A-YN20M01414D2 |
| CNH | YN20M01414D5 | A-YN20M01414D5 |
| CNH | YX20M01025P1 | A-YX20M01025P1 |
| CNH | Z938744 | A-Z938744 |
| CNH | Z938767 | A-Z938767 |
| CNH | 0.061361 | A-0.061361 |
| CNH | 47430047 | A-47430047 |
| CNH | 84150266 | A-84150266 |
| CNH | 84291570 | A-84291570 |
| CNH | 84312027 | A-84312027 |
| CNH | 86036924 | A-86036924 |

CLAAS



| OEM | OEM Part No. | PIX Part No. |
|-------|--------------|--------------|
| CLAAS | 0011035850 | A-0011035850 |
| CLAAS | 0067289.0 | A-0067289.0 |
| CLAAS | 008952.1 | A-008952.1 |
| CLAAS | 20344 | A-020344.0 |
| CLAAS | 020345.0 | A-020345.0 |
| CLAAS | 020600.0 | A-020600.0 |
| CLAAS | 20601 | A-020601.0 |
| CLAAS | 0223.4343 | A-0223.4343 |
| CLAAS | 023999.0 | A-023999.0 |
| CLAAS | 0423318 | A-0423318 |
| CLAAS | 0495067.0 | A-0495067.0 |
| CLAAS | 50090 | A-050090.0 |
| CLAAS | 51689 | A-051689.0 |
| CLAAS | 052393.1 | A-052393.1 |
| CLAAS | 055292.0 | A-055292.0 |
| CLAAS | 055893.0 | A-055893.0 |
| CLAAS | 60162 | A-060162.0 |
| CLAAS | 60239.1 | A-060239.1 |
| CLAAS | 060304.1 | A-060304.1 |
| CLAAS | 60306.4 | A-060306.4 |
| CLAAS | 060916.0 | A-060916.0 |
| CLAAS | 061204.0 | A-061204.0 |
| CLAAS | 061253.1 | A-061253.1 |
| CLAAS | 061306.0 | A-061306.0 |
| CLAAS | 061361.1 | A-061361.1 |
| CLAAS | 061872.1 | A-061872.1 |
| CLAAS | 64874 | A-064874.0 |
| CLAAS | 067290.0 | A-067290.0 |
| CLAAS | 067745.0 | A-067745.0 |
| CLAAS | 067746.0 | A-067746.0 |
| CLAAS | 067747.1 | A-067747.1 |
| CLAAS | 067789.0 | A-067789.0 |
| CLAAS | 68752 | A-068752.0 |
| CLAAS | 68752.1 | A-068752.1 |
| CLAAS | 68786 | A-068786.0 |
| CLAAS | 69925 | A-069925.0 |
| CLAAS | 070052.0 | A-070052.0 |
| CLAAS | 0743910.0 | A-0743910.0 |
| CLAAS | 074771.0 | A-074771.0 |
| CLAAS | 074771.2 | A-074771.2 |
| CLAAS | 076401.0 | A-076401.0 |
| CLAAS | 076403.1 | A-076403.1 |
| CLAAS | 077400.0 | A-077400.0 |
| CLAAS | 77401 | A-077401.0 |
| CLAAS | 077796.0 | A-077796.0 |
| CLAAS | 077797.0 | A-077797.0 |
| CLAAS | 081648.0 | A-081648.0 |



CLAAS

| OEM | OEM  Part No. | PIX  Part No. |
|-------|--|--|
| CLAAS | 083615.0 | A-083615.0 |
| CLAAS | 083668.0 | A-083668.0 |
| CLAAS | 083668.1 | A-083668.1 |
| CLAAS | 090255.0 | A-090255.0 |
| CLAAS | 090256.0 | A-090256.0 |
| CLAAS | 090256.1 | A-090256.1 |
| CLAAS | 094046.1 | A-094046.1 |
| CLAAS | 094046.2 | A-094046.2 |
| CLAAS | 0987883.0 | A-0987883.0 |
| CLAAS | 103735.0 | A-103735.0 |
| CLAAS | 104098.1 | A-104098.1 |
| CLAAS | 104237.1 | A-104237.1 |
| CLAAS | 104497 | A-104497.0 |
| CLAAS | 104914 | A-104914.0 |
| CLAAS | 104990 | A-104990.0 |
| CLAAS | 105580.0 | A-105580.0 |
| CLAAS | 105603.0 | A-105603.0 |
| CLAAS | 105860 | A-105860.0 |
| CLAAS | 105860.1 | A-105860.1 |
| CLAAS | 145265.0 | A-145265.0 |
| CLAAS | 146890.0 | A-146890.0 |
| CLAAS | 147217.0 | A-147217.0 |
| CLAAS | 147228.0 | A-147228.0 |
| CLAAS | 176432.0 | A-176432.0 |
| CLAAS | 176432.1 | A-176432.1 |
| CLAAS | 176440.1 | A-176440.1 |
| CLAAS | 176474.1 | A-176474.1 |
| CLAAS | 1764750 | A-1764750 |
| CLAAS | 176542.1 | A-176542.1 |
| CLAAS | 176544.0 | A-176544.0 |
| CLAAS | 181501.0 | A-181501.0 |
| CLAAS | 207050 | A-207050 |
| CLAAS | 207060 | A-207060 |
| CLAAS | 207080 | A-207080 |
| CLAAS | 207120 | A-207120 |
| CLAAS | 208200 | A-208200 |
| CLAAS | 211148.1 | A-211148.1 |
| CLAAS | 211240.0 | A-211240.0 |
| CLAAS | 212759.0 | A-212759.0 |
| CLAAS | 225850 | A-225850 |
| CLAAS | 233525 | A-233525.0 |
| CLAAS | 2338391 | A-2338391 |
| CLAAS | 2338392 | A-2338392 |
| CLAAS | 233943.1 | A-233943.1 |
| CLAAS | 2339831 | A-2339831 |
| CLAAS | 252420 | A-252420 |
| CLAAS | 261545.0 | A-261545.0 |

| OEM | OEM  Part No. | PIX  Part No. |
|-------|--|--|
| CLAAS | 310939.0 | A-310939.0 |
| CLAAS | 350340.0 | A-350340.0 |
| CLAAS | 350462.0 | A-350462.0 |
| CLAAS | 3504620 | A-3504620 |
| CLAAS | 350517.0 | A-350517.0 |
| CLAAS | 353706.0 | A-353706.0 |
| CLAAS | 495067.1 | A-495067.1 |
| CLAAS | 500273.1 | A-500273.1 |
| CLAAS | 500867.0 | A-500867.0 |
| CLAAS | 500868.0 | A-500868.0 |
| CLAAS | 5017700 | A-5017700 |
| CLAAS | 501771.0 | A-501771.0 |
| CLAAS | 501802.0 | A-501802.0 |
| CLAAS | 501903.0 | A-501903.0 |
| CLAAS | 503459 | A-503459.0 |
| CLAAS | 503969.0 | A-503969.0 |
| CLAAS | 5039690 | A-5039690 |
| CLAAS | 505022 | A-505022.0 |
| CLAAS | 505051 | A-505051 |
| CLAAS | 505112 | A-505112.0 |
| CLAAS | 505113.1 | A-505113.1 |
| CLAAS | 505143.0 | A-505143.0 |
| CLAAS | 505143.1 | A-505143.1 |
| CLAAS | 506792.1 | A-506792.1 |
| CLAAS | 507020.0 | A-507020.0 |
| CLAAS | 507100.0 | A-507100.0 |
| CLAAS | 507278.0 | A-507278.0 |
| CLAAS | 507317 | A-507317.0 |
| CLAAS | 507317.1 | A-507317.1 |
| CLAAS | 507508.0 | A-507508.0 |
| CLAAS | 507626.0 | A-507626.0 |
| CLAAS | 507723.0 | A-507723.0 |
| CLAAS | 507908.0 | A-507908.0 |
| CLAAS | 509035 | A-509035.0 |
| CLAAS | 509206 | A-509206.0 |
| CLAAS | 512087.0 | A-512087.0 |
| CLAAS | 519836 | A-519836 |
| CLAAS | 528305.0 | A-528305.0 |
| CLAAS | 532011.1 | A-532011.1 |
| CLAAS | 544114.0 | A-544114.0 |
| CLAAS | 544115.0 | A-544115.0 |
| CLAAS | 544216.1 | A-544216.1 |
| CLAAS | 545307.0 | A-545307.0 |
| CLAAS | 5491510 | A-5491510 |
| CLAAS | 549238.0 | A-549238.0 |
| CLAAS | 549752.1 | A-549752.1 |
| CLAAS | 5540160 | A-5540160 |



CLAAS

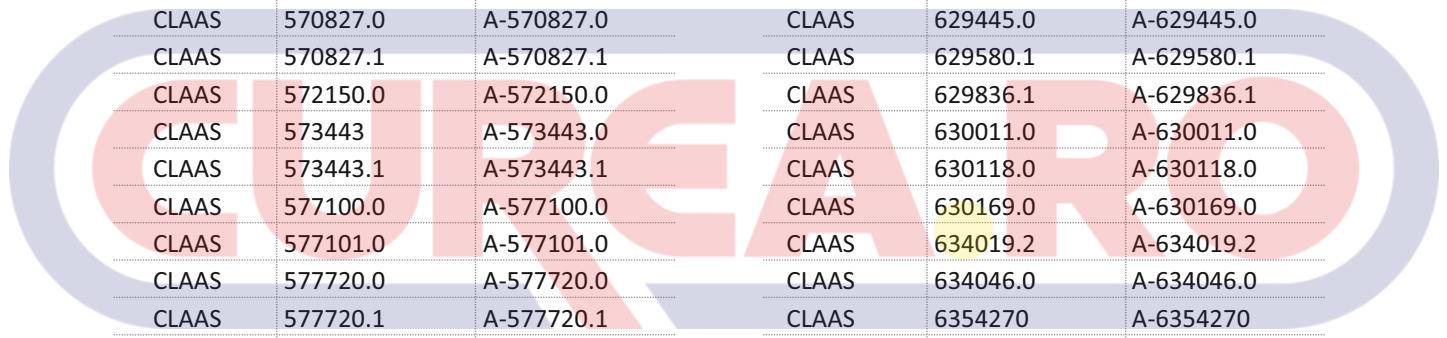

| OEM | OEM  Part No. | PIX  Part No. |
|-------|--|--|
| CLAAS | 554086.0 | A-554086.0 |
| CLAAS | 5540860 | A-5540860 |
| CLAAS | 554172.0 | A-554172.0 |
| CLAAS | 554186.0 | A-554186.0 |
| CLAAS | 5541860 | A-5541860 |
| CLAAS | 554269.0 | A-554269.0 |
| CLAAS | 554339.0 | A-554339.0 |
| CLAAS | 5543650 | A-5543650 |
| CLAAS | 560690.0 | A-560690.0 |
| CLAAS | 566108.0 | A-566108.0 |
| CLAAS | 567824.0 | A-567824.0 |
| CLAAS | 567825.0 | A-567825.0 |
| CLAAS | 569528.0 | A-569528.0 |
| CLAAS | 570195.0 | A-570195.0 |
| CLAAS | 570195.1 | A-570195.1 |
| CLAAS | 5701950 | A-5701950 |
| CLAAS | 570407.0 | A-570407.0 |
| CLAAS | 570407.1 | A-570407.1 |
| CLAAS | 570827.0 | A-570827.0 |
| CLAAS | 570827.1 | A-570827.1 |
| CLAAS | 572150.0 | A-572150.0 |
| CLAAS | 573443 | A-573443.0 |
| CLAAS | 573443.1 | A-573443.1 |
| CLAAS | 577100.0 | A-577100.0 |
| CLAAS | 577101.0 | A-577101.0 |
| CLAAS | 577720.0 | A-577720.0 |
| CLAAS | 577720.1 | A-577720.1 |
| CLAAS | 577721.0 | A-577721.0 |
| CLAAS | 578331.0 | A-578331.0 |
| CLAAS | 578332.0 | A-578332.0 |
| CLAAS | 580166.0 | A-580166.0 |
| CLAAS | 583940 | A-583940 |
| CLAAS | 603013.1 | A-603013.1 |
| CLAAS | 603063 | A-603063 |
| CLAAS | 609491 | A-609491 |
| CLAAS | 60954 | A-60954 |
| CLAAS | 609726 | A-609726 |
| CLAAS | 610144.0 | A-610144.0 |
| CLAAS | 610152.1 | A-610152.1 |
| CLAAS | 610833.1 | A-610833.1 |
| CLAAS | 61252 | A-61252 |
| CLAAS | 612531 | A-612531 |
| CLAAS | 617309.2 | A-617309.2 |
| CLAAS | 618720 | A-618720 |
| CLAAS | 622156.0 | A-622156.0 |
| CLAAS | 622156.1 | A-622156.1 |
| CLAAS | 623252.0 | A-623252.0 |

| OEM | OEM  Part No. | PIX  Part No. |
|-------|--|--|
| CLAAS | 623425.0 | A-623425.0 |
| CLAAS | 628175 | A-628175.0 |
| CLAAS | 628533.0 | A-628533.0 |
| CLAAS | 628579.1 | A-628579.1 |
| CLAAS | 628779.1 | A-628779.1 |
| CLAAS | 628780.0 | A-628780.0 |
| CLAAS | 628782.0 | A-628782.0 |
| CLAAS | 628784.0 | A-628784.0 |
| CLAAS | 628785.0 | A-628785.0 |
| CLAAS | 628787.0 | A-628787.0 |
| CLAAS | 628788.0 | A-628788.0 |
| CLAAS | 628791.0 | A-628791.0 |
| CLAAS | 628981 | A-628981.0 |
| CLAAS | 629081.1 | A-629081.1 |
| CLAAS | 629133.0 | A-629133.0 |
| CLAAS | 629133.1 | A-629133.1 |
| CLAAS | 629410.1 | A-629410.1 |
| CLAAS | 629441.1 | A-629441.1 |
| CLAAS | 629445.0 | A-629445.0 |
| CLAAS | 629580.1 | A-629580.1 |
| CLAAS | 629836.1 | A-629836.1 |
| CLAAS | 630011.0 | A-630011.0 |
| CLAAS | 630118.0 | A-630118.0 |
| CLAAS | 630169.0 | A-630169.0 |
| CLAAS | 634019.2 | A-634019.2 |
| CLAAS | 634046.0 | A-634046.0 |
| CLAAS | 6354270 | A-6354270 |
| CLAAS | 635940 | A-635940 |
| CLAAS | 638037.1 | A-638037.1 |
| CLAAS | 639226.2 | A-639226.2 |
| CLAAS | 639373.0 | A-639373.0 |
| CLAAS | 639417 | A-639417.0 |
| CLAAS | 644209.2 | A-644209.2 |
| CLAAS | 644368.1 | A-644368.1 |
| CLAAS | 644369.1 | A-644369.1 |
| CLAAS | 644391.0 | A-644391.0 |
| CLAAS | 644405.2 | A-644405.2 |
| CLAAS | 644419.1 | A-644419.1 |
| CLAAS | 644509 | A-644509.0 |
| CLAAS | 644514.0 | A-644514.0 |
| CLAAS | 644781.1 | A-644781.1 |
| CLAAS | 644891.0 | A-644891.0 |
| CLAAS | 644893.0 | A-644893.0 |
| CLAAS | 644894.0 | A-644894.0 |
| CLAAS | 644895.0 | A-644895.0 |
| CLAAS | 644896.0 | A-644896.0 |
| CLAAS | 644897.0 | A-644897.0 |







CLAAS

| OEM | OEM  Part No. | PIX  Part No. |
|-------|--|--|
| CLAAS | 644898.0 | A-644898.0 |
| CLAAS | 644899 | A-644899.0 |
| CLAAS | 644927.0 | A-644927.0 |
| CLAAS | 644928.1 | A-644928.1 |
| CLAAS | 644969.0 | A-644969.0 |
| CLAAS | 660315.0 | A-660315.0 |
| CLAAS | 660316.0 | A-660316.0 |
| CLAAS | 660382.0 | A-660382.0 |
| CLAAS | 660423.0 | A-660423.0 |
| CLAAS | 660504 | A-660504 |
| CLAAS | 6605040 | A-6605040 |
| CLAAS | 660566.0 | A-660566.0 |
| CLAAS | 660568.0 | A-660568.0 |
| CLAAS | 660587.0 | A-660587.0 |
| CLAAS | 661031.2 | A-661031.2 |
| CLAAS | 661128.0 | A-661128.0 |
| CLAAS | 661301.1 | A-661301.1 |
| CLAAS | 661337.1 | A-661337.1 |
| CLAAS | 661361 | A-661361.0 |
| CLAAS | 6613622 | A-6613622 |
| CLAAS | 661378.2 | A-661378.2 |
| CLAAS | 661435 | A-661435.0 |
| CLAAS | 661469 | A-661469.0 |
| CLAAS | 663093.0 | A-663093.0 |
| CLAAS | 664017 | A-664017.0 |
| CLAAS | 667219.0 | A-667219.0 |
| CLAAS | 667245 | A-667245.0 |
| CLAAS | 667246 | A-667246.0 |
| CLAAS | 667253.0 | A-667253.0 |
| CLAAS | 667256.0 | A-667256.0 |
| CLAAS | 667454.1 | A-667454.1 |
| CLAAS | 667511 | A-667511.0 |
| CLAAS | 667551.2 | A-667551.2 |
| CLAAS | 667682.0 | A-667682.0 |
| CLAAS | 667788.0 | A-667788.0 |
| CLAAS | 667798 | A-667798.0 |
| CLAAS | 667798.1 | A-667798.1 |
| CLAAS | 667845 | A-667845.0 |
| CLAAS | 667846 | A-667846.0 |
| CLAAS | 667858.0 | A-667858.0 |
| CLAAS | 667958.1 | A-667958.1 |
| CLAAS | 6679583 | A-6679583 |
| CLAAS | 667981.0 | A-667981.0 |
| CLAAS | 667981.1 | A-667981.1 |
| CLAAS | 668619.0 | A-668619.0 |
| CLAAS | 672350.1 | A-672350.1 |
| CLAAS | 672359.1 | A-672359.1 |



| OEM | OEM  Part No. | PIX  Part No. |
|-------|--|--|
| CLAAS | 673639.1 | A-673639.1 |
| CLAAS | 673690.1 | A-673690.1 |
| CLAAS | 701344 | A-701344 |
| CLAAS | 707001.1 | A-707001.1 |
| CLAAS | 712419.0 | A-712419.0 |
| CLAAS | 7124192 | A-7124192 |
| CLAAS | 720607 | A-720607.1 |
| CLAAS | 720607.1 | A-720607.1 |
| CLAAS | 721211.0 | A-721211.0 |
| CLAAS | 721295.0 | A-721295.0 |
| CLAAS | 722107.0 | A-722107.0 |
| CLAAS | 724043.0 | A-724043.0 |
| CLAAS | 7241 | A-7241 |
| CLAAS | 724193.0 | A-724193.0 |
| CLAAS | 724301.1 | A-724301.1 |
| CLAAS | 733308 | A-733308.0 |
| CLAAS | 733309.0 | A-733309.0 |
| CLAAS | 733311 | A-733311.0 |
| CLAAS | 733361.0 | A-733361.0 |
| CLAAS | 742023.0 | A-742023.0 |
| CLAAS | 742024.0 | A-742024.0 |
| CLAAS | 742026.1 | A-742026.1 |
| CLAAS | 742027 | A-742027.0 |
| CLAAS | 742028.0 | A-742028.0 |
| CLAAS | 742030 | A-742030.0 |
| CLAAS | 742131.1 | A-742131.1 |
| CLAAS | 742143 | A-742143.0 |
| CLAAS | 742162.0 | A-742162.0 |
| CLAAS | 742182.0 | A-742182.0 |
| CLAAS | 742206.0 | A-742206.0 |
| CLAAS | 744833.0 | A-744833.0 |
| CLAAS | 744833.1 | A-744833.1 |
| CLAAS | 744913 | A-744913.0 |
| CLAAS | 745025.0 | A-745025.0 |
| CLAAS | 746505.0 | A-746505.0 |
| CLAAS | 746507.0 | A-746507.0 |
| CLAAS | 746508.3 | A-746508.3 |
| CLAAS | 746509 | A-746509 |
| CLAAS | 747508.0 | A-747508.0 |
| CLAAS | 749701.0 | A-749701.0 |
| CLAAS | 749813.0 | A-749813.0 |
| CLAAS | 749817 | A-749817.0 |
| CLAAS | 749819.0 | A-749819.0 |
| CLAAS | 7498240 | A-7498240 |
| CLAAS | 749914 | A-749914.0 |
| CLAAS | 750192 | A-750192.0 |
| CLAAS | 750193.1 | A-750193.1 |

CLAAS

| OEM | OEM  Part No. | PIX  Part No. |
|-------|--|--|
| CLAAS | 750284.0 | A-750284.0 |
| CLAAS | 750288.1 | A-750288.1 |
| CLAAS | 750295.0 | A-750295.0 |
| CLAAS | 750316.0 | A-750316.0 |
| CLAAS | 750382.0 | A-750382.0 |
| CLAAS | 750382.1 | A-750382.1 |
| CLAAS | 750382.2 | A-750382.2 |
| CLAAS | 750451.0 | A-750451.0 |
| CLAAS | 750779 | A-750779.0 |
| CLAAS | 750888.0 | A-750888.0 |
| CLAAS | 755070.2 | A-755070.2 |
| CLAAS | 756446.0 | A-756446.0 |
| CLAAS | 756474.0 | A-756474.0 |
| CLAAS | 758622 | A-758622 |
| CLAAS | 758729 | A-758729 |
| CLAAS | 760869.0 | A-760869.0 |
| CLAAS | 760870.0 | A-760870.0 |
| CLAAS | 760870.1 | A-760870.1 |
| CLAAS | 761412.0 | A-761412.0 |
| CLAAS | 768125.0 | A-768125.0 |
| CLAAS | 769005 | A-769005.0 |
| CLAAS | 7700035746 | A-7700035746 |
| CLAAS | 7700037114 | A-7700037114 |
| CLAAS | 7700037116 | A-7700037116 |
| CLAAS | 7700043752 | A-7700043752 |
| CLAAS | 7700048822 | A-7700048822 |
| CLAAS | 7700050889 | A-7700050889 |
| CLAAS | 7700057145 | A-7700057145 |
| CLAAS | 7700059172 | A-7700059172 |
| CLAAS | 7700062256 | A-7700062256 |
| CLAAS | 7700062485 | A-7700062485 |
| CLAAS | 7700066453 | A-7700066453 |
| CLAAS | 7700066699 | A-7700066699 |
| CLAAS | 7700066725 | A-7700066725 |
| CLAAS | 770718 | A-770718.0 |
| CLAAS | 772647.1 | A-772647.1 |
| CLAAS | 772657.1 | A-772657.1 |
| CLAAS | 772659.0 | A-772659.0 |
| CLAAS | 775049.0 | A-775049.0 |
| CLAAS | 781038 | A-781038.0 |
| CLAAS | 781047.0 | A-781047.0 |
| CLAAS | 781394.0 | A-781394.0 |
| CLAAS | 781399 | A-781399.0 |
| CLAAS | 781400 | A-781400.0 |
| CLAAS | 783429 | A-783429.0 |
| CLAAS | 783430.0 | A-783430.0 |
| CLAAS | 783896 | A-783896 |

| OEM | OEM  Part No. | PIX  Part No. |
|-------|--|--|
| CLAAS | 785168.2 | A-785168.2 |
| CLAAS | 785169.0 | A-785169.0 |
| CLAAS | 785170 | A-785170.0 |
| CLAAS | 785172 | A-785172 |
| CLAAS | 785172.1 | A-785172.1 |
| CLAAS | 785173.0 | A-785173.0 |
| CLAAS | 785174.1 | A-785174.1 |
| CLAAS | 785175 | A-785175.0 |
| CLAAS | 790461.0 | A-790461.0 |
| CLAAS | 790502 | A-790502.0 |
| CLAAS | 791307.0 | A-791307.0 |
| CLAAS | 796343.0 | A-796343.0 |
| CLAAS | 796344.0 | A-796344.0 |
| CLAAS | 798779.0 | A-798779.0 |
| CLAAS | 800306 | A-800306.0 |
| CLAAS | 801491.0 | A-801491.0 |
| CLAAS | 801680 | A-801680.0 |
| CLAAS | 802530 | A-802530.0 |
| CLAAS | 808761 | A-808761.0 |
| CLAAS | 821249.0 | A-821249.0 |
| CLAAS | 821734.0 | A-821734.0 |
| CLAAS | 821813.0 | A-821813.0 |
| CLAAS | 825944.0 | A-825944.0 |
| CLAAS | 829080.0 | A-829080.0 |
| CLAAS | 837192.0 | A-837192.0 |
| CLAAS | 837195.0 | A-837195.0 |
| CLAAS | 837543.0 | A-837543.0 |
| CLAAS | 837546.0 | A-837546.0 |
| CLAAS | 837828.0 | A-837828.0 |
| CLAAS | 838227.0 | A-838227.0 |
| CLAAS | 895105.0 | A-895105.0 |
| CLAAS | 901573.0 | A-901573.0 |
| CLAAS | 906561.0 | A-906561.0 |
| CLAAS | 906736.0 | A-906736.0 |
| CLAAS | 906736.1 | A-906736.1 |
| CLAAS | 9067360 | A-9067360 |
| CLAAS | 9141490 | A-9141490 |
| CLAAS | 916529.0 | A-916529.0 |
| CLAAS | 916529.1 | A-916529.1 |
| CLAAS | 916532.1 | A-916532.1 |
| CLAAS | 917533.0 | A-917533.0 |
| CLAAS | 922188.0 | A-922188.0 |
| CLAAS | 927654 | A-927654.0 |
| CLAAS | 934301.0 | A-934301.0 |
| CLAAS | 934417.2 | A-934417.2 |
| CLAAS | 934418.1 | A-934418.1 |
| CLAAS | 934418.2 | A-934418.2 |



CLAAS

| OEM | OEM  Part No. | PIX  Part No. |
|-------|--|--|
| CLAAS | 934862.0 | A-934862.0 |
| CLAAS | 936409 | A-936409.0 |
| CLAAS | 936718.0 | A-936718.0 |
| CLAAS | 937031.0 | A-937031.0 |
| CLAAS | 937997.0 | A-937997.0 |
| CLAAS | 938171.0 | A-938171.0 |
| CLAAS | 938171.2 | A-938171.2 |
| CLAAS | 938486 | A-938486.0 |
| CLAAS | 938931 | A-938931.0 |
| CLAAS | 939297 | A-939297.0 |
| CLAAS | 943227.0 | A-943227.0 |
| CLAAS | 947112 | A-947112.0 |
| CLAAS | 947916.0 | A-947916.0 |
| CLAAS | 949396.0 | A-949396.0 |
| CLAAS | 949670 | A-949670.0 |
| CLAAS | 949888 | A-949888.0 |
| CLAAS | 950133 | A-950133.0 |
| CLAAS | 950327 | A-950327.0 |
| CLAAS | 950890.0 | A-950890.0 |
| CLAAS | 951003.6 | A-951003.6 |
| CLAAS | 951457.0 | A-951457.0 |
| CLAAS | 951654.0 | A-951654.0 |
| CLAAS | 951655.0 | A-951655.0 |
| CLAAS | 951889 | A-951889.0 |
| CLAAS | 951917 | A-951917.0 |
| CLAAS | 952578 | A-952578.0 |
| CLAAS | 952937 | A-952937.0 |
| CLAAS | 953002.8 | A-953002.8 |
| CLAAS | 980850.0 | A-980850.0 |
| CLAAS | 980852.0 | A-980852.0 |
| CLAAS | 980852.1 | A-980852.1 |
| CLAAS | 980853 | A-980853.0 |
| CLAAS | 981678.0 | A-981678.0 |
| CLAAS | 982376 | A-982376.0 |
| CLAAS | 982376.1 | A-982376.1 |
| CLAAS | 984885.0 | A-984885.0 |
| CLAAS | 984885.1 | A-984885.1 |
| CLAAS | 9848850 | A-9848850 |
| CLAAS | 985517.0 | A-985517.0 |
| CLAAS | 986390.0 | A-986390.0 |
| CLAAS | 986700.1 | A-986700.1 |
| CLAAS | AN1462 | A-AN1462 |
| CLAAS | 01397732 | A-01397732 |
| CLAAS | 545668.2 | A-545668.2 |
| CLAAS | 549055.1 | A-549055.1 |
| CLAAS | 554031.0 | A-554031.0 |
| CLAAS | 554099.1 | A-554099.1 |
| CLAAS | 570195.2 | A-570195.2 |
| CLAAS | 629539.2 | A-629539.2 |
| CLAAS | 644362.1 | A-644362.1 |
| CLAAS | 660488.0 | A-660488.0 |
| CLAAS | 660762.1 | A-660762.1 |
| CLAAS | 667255.1 | A-667255.1 |
| CLAAS | 670796.0 | A-670796.0 |



DEUTZ FAHR

| OEM | OEM  Part No. | PIX  Part No. |
|------------|--|--|
| DEUTZ FAHR | 06215196 | A-06215196 |
| DEUTZ FAHR | 06215199 | A-06215199 |
| DEUTZ FAHR | 06215209 | A-06215209 |
| DEUTZ FAHR | 06215213 | A-06215213 |
| DEUTZ FAHR | 06215237 | A-06215237 |
| DEUTZ FAHR | 06215250 | A-06215250 |
| DEUTZ FAHR | 06215261 | A-06215261 |
| DEUTZ FAHR | 06234476 | A-06234476 |
| DEUTZ FAHR | 06236657 | A-06236657 |
| DEUTZ FAHR | 06240268 | A-06240268 |
| DEUTZ FAHR | 06241305 | A-06241305 |
| DEUTZ FAHR | 088-002215-0.302 | A-088-002215-0.302 |
| DEUTZ FAHR | 088-002215-0.484 | A-088-002215-0.484 |
| DEUTZ FAHR | 088-002215-2.162 | A-088-002215-2.162 |
| DEUTZ FAHR | 088-002215-3.165 | A-088-002215-3.165 |
| DEUTZ FAHR | 088-002215-3.315 | A-088-002215-3.315 |
| DEUTZ FAHR | 088-002215-3.355 | A-088-002215-3.355 |
| DEUTZ FAHR | 088-002215-5.276 | A-088-002215-5.276 |
| DEUTZ FAHR | 088-002215-5.280 | A-088-002215-5.280 |
| DEUTZ FAHR | 088-007753-2.080 | A-088-007753-2.080 |
| DEUTZ FAHR | 088-007753-3.132 | A-088-007753-3.132 |
| DEUTZ FAHR | 088-007753-4.344 | A-088-007753-4.344 |
| DEUTZ FAHR | 088-007753-4.369 | A-088-007753-4.369 |
| DEUTZ FAHR | 088-007753-6.355 | A-088-007753-6.355 |
| DEUTZ FAHR | 088-007753-6.560 | A-088-007753-6.560 |
| DEUTZ FAHR | 089-000946-1.806 | A-089-000946-1.806 |
| DEUTZ FAHR | 089-000946-6.044 | A-089-000946-6.044 |
| DEUTZ FAHR | 089-000946-6.051 | A-089-000946-6.051 |
| DEUTZ FAHR | 089-000946-6.053 | A-089-000946-6.053 |
| DEUTZ FAHR | 089-000946-6.184 | A-089-000946-6.184 |
| DEUTZ FAHR | 089-000946-6.191 | A-089-000946-6.191 |
| DEUTZ FAHR | 1116.140.134.00 | A-1116.140.134.00 |
| DEUTZ FAHR | 1-1207-140-198.00 | A-1-1207-140-198.00 |
| DEUTZ FAHR | 1-1207-370-119.00 | A-1-1207-370-119.00 |
| DEUTZ FAHR | 1123.464.465.000 | A-1123.464.465.000 |
| DEUTZ FAHR | 1123.664.100.00 | A-1123.664.100.00 |
| DEUTZ FAHR | 1123.664.101.00 | A-1123.664.101.00 |
| DEUTZ FAHR | 1123.664.102.00 | A-1123.664.102.00 |
| DEUTZ FAHR | 1130.375.100.00 | A-1130.375.100.00 |
| DEUTZ FAHR | 1142913 | A-1142913 |
| DEUTZ FAHR | 1145330 | A-1145330 |
| DEUTZ FAHR | 117.5766 | A-117.5766 |
| DEUTZ FAHR | 1170.290.108.00 | A-1170.290.108.00 |
| DEUTZ FAHR | 1170.290.110.00 | A-1170.290.110.00 |
| DEUTZ FAHR | 1170.370.156.00 | A-1170.370.156.00 |
| DEUTZ FAHR | 1175.025.184.00 | A-1175.025.184.00 |
| DEUTZ FAHR | 1175.025.185.00 | A-1175.025.185.00 |



DEUTZ FAHR

| OEM | OEM  Part No. | PIX  Part No. |
|------------|--|--|
| DEUTZ FAHR | 1175.026.160.00 | A-1175.026.160.00 |
| DEUTZ FAHR | 1175.091.124.00 | A-1175.091.124.00 |
| DEUTZ FAHR | 1175.120.109.00 | A-1175.120.109.00 |
| DEUTZ FAHR | 1175.185.129.00 | A-1175.185.129.00 |
| DEUTZ FAHR | 1175.225.138.00 | A-1175.225.138.00 |
| DEUTZ FAHR | 1175.295.118.00 | A-1175.295.118.00 |
| DEUTZ FAHR | 1175.300.129.00 | A-1175.300.129.00 |
| DEUTZ FAHR | 1175.375.104.00 | A-1175.375.104.00 |
| DEUTZ FAHR | 1-2107-100-116.00 | A-1-2107-100-116.00 |
| DEUTZ FAHR | 1-2107-120-159.10 | A-1-2107-120-159.10 |
| DEUTZ FAHR | 1-2107-130-139.00 | A-1-2107-130-139.00 |
| DEUTZ FAHR | 16604333 | A-16604333 |
| DEUTZ FAHR | 223.518 | A-223.518 |
| DEUTZ FAHR | 223.5264 | A-223.5264 |
| DEUTZ FAHR | 30012900 | A-30012900 |
| DEUTZ FAHR | 3602 | A-3602 |
| DEUTZ FAHR | 43303430 | A-43303430 |
| DEUTZ FAHR | 6212835 | A-6212835 |
| DEUTZ FAHR | 6215210 | A-6215210 |
| DEUTZ FAHR | 6215252 | A-6215252 |
| DEUTZ FAHR | 6580024 | A-6580024 |
| DEUTZ FAHR | 8800.2215.6.280 | A-8800.2215.6.280 |
| DEUTZ FAHR | 8900094 | A-8900094 |
| DEUTZ FAHR | 890009461888 | A-890009461888 |
| DEUTZ FAHR | 890009466184 | A-890009466184 |
| DEUTZ FAHR | ND9081 | A-ND9081 |
| DEUTZ FAHR | 4221668165 | A-4221668165 |



FORTSCHRITT

| OEM | OEM  Part No. | PIX  Part No. |
|-------------|--|--|
| FORTSCHRITT | 9911861573 | A-9911861573 |
| FORTSCHRITT | 9911861532 | A-9911861532 |
| FORTSCHRITT | 9911861846 | A-9911861846 |
| FORTSCHRITT | 9911861557 | A-9911861557 |
| FORTSCHRITT | 9911861452 | A-9911861452 |
| FORTSCHRITT | 9911861821 | A-9911861821 |
| FORTSCHRITT | 4043403771 | A-4043403771 |
| FORTSCHRITT | 4129785100 | A-4129785100 |
| FORTSCHRITT | 4247040968 | A-4247040968 |
| FORTSCHRITT | 9911860396 | A-9911860396 |
| FORTSCHRITT | 4031827973 | A-4031827973 |
| FORTSCHRITT | 0.61009082 | A-0.61009082 |
| FORTSCHRITT | 4032804306 | A-4032804306 |
| FORTSCHRITT | 9911860757 | A-9911860757 |
| FORTSCHRITT | 9911860765 | A-9911860765 |
| FORTSCHRITT | 4032804291 | A-4032804291 |
| FORTSCHRITT | B9502224 | A-B9502224 |
| FORTSCHRITT | B9502232 | A-B9502232 |
| FORTSCHRITT | B9502225 | A-B9502225 |
| FORTSCHRITT | B9502025 | A-B9502025 |
| FORTSCHRITT | B9502122 | A-B9502122 |
| FORTSCHRITT | B9502134 | A-B9502134 |
| FORTSCHRITT | B9502131 | A-B9502131 |
| FORTSCHRITT | B9502209 | A-B9502209 |
| FORTSCHRITT | B9502207 | A-B9502207 |
| FORTSCHRITT | B9502210 | A-B9502210 |
| FORTSCHRITT | B9502246 | A-B9502246 |
| FORTSCHRITT | B9502260 | A-B9502260 |
| FORTSCHRITT | B9502259 | A-B9502259 |
| FORTSCHRITT | B9502120 | A-B9502120 |
| FORTSCHRITT | B9502226 | A-B9502226 |
| FORTSCHRITT | B9502265 | A-B9502265 |
| FORTSCHRITT | B9502229 | A-B9502229 |
| FORTSCHRITT | B9502247 | A-B9502247 |
| FORTSCHRITT | B9502227 | A-B9502227 |
| FORTSCHRITT | B9502261 | A-B9502261 |
| FORTSCHRITT | 4250212780 | A-4250212780 |
| FORTSCHRITT | 204711250 | A-204711250 |
| FORTSCHRITT | 06014350 | A-06014350 |
| FORTSCHRITT | 4221121885 | A-4221121885 |





GRIMME

| OEM | OEM  Part No. | PIX  Part No. |
|--------|--|--|
| GRIMME | B95.02170 | A-B95.02170 |
| GRIMME | B95.02245 | A-B95.02245 |
| GRIMME | B95.02244 | A-B95.02244 |
| GRIMME | B95.02047 | A-B95.02047 |
| GRIMME | B9502263 | A-B9502263 |
| GRIMME | B9502262 | A-B9502262 |
| GRIMME | B9502228 | A-B9502228 |
| GRIMME | B9502223 | A-B9502223 |
| GRIMME | B9502155 | A-B9502155 |
| GRIMME | B9502004 | A-B9502004 |
| GRIMME | B9502005 | A-B9502005 |
| GRIMME | B9502006 | A-B9502006 |
| GRIMME | B9502166 | A-B9502166 |
| GRIMME | B9502158 | A-B9502158 |
| GRIMME | B9502165 | A-B9502165 |
| GRIMME | B9502167 | A-B9502167 |
| GRIMME | B9502149 | A-B9502149 |
| GRIMME | B9502152 | A-B9502152 |
| GRIMME | B9502205 | A-B9502205 |
| GRIMME | B9502241 | A-B9502241 |
| GRIMME | B9502150 | A-B9502150 |
| GRIMME | B9502162 | A-B9502162 |
| GRIMME | B9502250 | A-B9502250 |
| GRIMME | B9502114 | A-B9502114 |
| GRIMME | B9502188 | A-B9502188 |
| GRIMME | B9502193 | A-B9502193 |
| GRIMME | B9502145 | A-B9502145 |
| GRIMME | B9502208 | A-B9502208 |
| GRIMME | B9502125 | A-B9502125 |
| GRIMME | B9502116 | A-B9502116 |
| GRIMME | B9502045 | A-B9502045 |
| GRIMME | B9502171 | A-B9502171 |
| GRIMME | B9502128 | A-B9502128 |
| GRIMME | B9502070 | A-B9502070 |
| GRIMME | B9502142 | A-B9502142 |
| GRIMME | B9502126 | A-B9502126 |





HORWOOD BAGSHAW (HB)

| OEM | OEM  Part No. | PIX  Part No. |
|-----|--|--|
| HB | 10160 | A-10160 |
| HB | 13526 | A-13526 |
| HB | 530.3120P3 | A-530.3120P3 |
| HB | 10121 | A-10121 |
| HB | 530.3120P4 | A-530.3120P4 |
| HB | 530.1105 | A-530.1105 |
| HB | 530.1108 | A-530.1108 |
| HB | 530.1112 | A-530.1112 |
| HB | 530.112 | A-530.112 |
| HB | 530.1128 | A-530.1128 |
| HB | 530.1136 | A-530.1136 |
| HB | 530.114 | A-530.114 |
| HB | 530.1031 | A-530.1031 |
| HB | 530.0351 | A-530.0351 |
| HB | Cs975 | A-CS975 |
| HB | 530.1035 | A-530.1035 |
| HB | 530.1036 | A-530.1036 |
| HB | 530.1038 | A-530.1038 |
| HB | 530.1402 | A-530.1402 |
| HB | 530.1046 | A-530.1046 |
| HB | 530.1048 | A-530.1048 |
| HB | 530.1051 | A-530.1051 |
| HB | 530.053 | A-530.053 |
| HB | 530.055 | A-530.055 |
| HB | 530.1056 | A-530.1056 |
| HB | 530.1058 | A-530.1058 |
| HB | 0156910001 | A-0156910001 |
| HB | 530.106 | A-530.106 |
| HB | 530.1062 | A-530.1062 |
| HB | 530.1064 | A-530.1064 |
| HB | 530.073 | A-530.073 |
| HB | 530.1074 | A-530.1074 |
| HB | 530.1075 | A-530.1075 |
| HB | 530.1078 | A-530.1078 |
| HB | 530.018 | A-530.018 |
| HB | 530.081 | A-530.081 |
| HB | 530.1085 | A-530.1085 |
| HB | 530.1087 | A-530.1087 |
| HB | 530.1088 | A-530.1088 |
| HB | 530.109 | A-530.109 |
| HB | Cs976 | A-CS976 |
| HB | 530.1093 | A-530.1093 |
| HB | 530.0985 | A-530.0985 |
| HB | 10150 | A-10150 |
| HB | 530.0992 | A-530.0992 |
| HB | 530.1002 | A-530.1002 |
| HB | 10151 | A-10151 |





HORWOOD BAGSHAW (HB)

| OEM | OEM  Part No. | PIX  Part No. | OEM | OEM  Part No. | PIX  Part No. |
|-----|--|--|-----|--|--|
| HB | 530.1026 | A-530.1026 | HB | 530.0516 | A-530.0516 |
| HB | Cs977 | A-CS977 | HB | 10162 | A-10162 |
| HB | 10163 | A-10163 | HB | 530.2051 | A-530.2051 |
| HB | 0156910103 | A-0156910103 | HB | 10148 | A-10148 |
| HB | 10165 | A-10165 | HB | 530.0525 | A-530.0525 |
| HB | 530.2105-3 | A-530.2105-3 | HB | 530.2054 | A-530.2054 |
| HB | 0156910104 | A-0156910104 | HB | 530.2055 | A-530.2055 |
| HB | 530.2107-3 | A-530.2107-3 | HB | 10161 | A-10161 |
| HB | 530.2107 | A-530.2107 | HB | 530.06 | A-530.06 |
| HB | 530.111B2 | A-530.111B2 | HB | 10166 | A-10166 |
| HB | 530.1121 | A-530.1121 | HB | 530.206 | A-530.206 |
| HB | 530.2112 | A-530.2112 | HB | 10141 | A-10141 |
| HB | 10152 | A-10152 | HB | Cs2399 | A-CS2399 |
| HB | 530.1187 | A-530.1187 | HB | 530.2063 | A-530.2063 |
| HB | 530.1211 | A-530.1211 | HB | 0156910102 | A-0156910102 |
| HB | 530.212 | A-530.212 | HB | 13516 | A-13516 |
| HB | 530.412 | A-530.412 | HB | 530.0695 | A-530.0695 |
| HB | 530.1252 | A-530.1252 | HB | 530.2068 | A-530.2068 |
| HB | 530.2124 | A-530.2124 | HB | 530.2069 | A-530.2069 |
| HB | 530.2128 | A-530.2128 | HB | 530.207 | A-530.207 |
| HB | 530.2132 | A-530.2132 | HB | 530.0727 | A-530.0727 |
| HB | 10153 | A-10153 | HB | 530.2071 | A-530.2071 |
| HB | 530.1377 | A-530.1377 | HB | 530.2072 | A-530.2072 |
| HB | 530.2136 | A-530.2136 | HB | 10142 | A-10142 |
| HB | 530.141 | A-530.141 | HB | 10143 | A-10143 |
| HB | 0156910106 | A-0156910106 | HB | 530.0757 | A-530.0757 |
| HB | 530.1455 | A-530.1455 | HB | Cs1479 | A-CS1479 |
| HB | 530.2143 | A-530.2143 | HB | 10145 | A-10145 |
| HB | 530.2144 | A-530.2144 | HB | 530.2075 | A-530.2075 |
| HB | 530.2152 | A-530.2152 | HB | 530.0774 | A-530.0774 |
| HB | 530.216 | A-530.216 | HB | 530.2076 | A-530.2076 |
| HB | 10154 | A-10154 | HB | 530.0802 | A-530.0802 |
| HB | 530.2162 | A-530.2162 | HB | 10144 | A-10144 |
| HB | 530.1701 | A-530.1701 | HB | Cs978 | A-CS978 |
| HB | 10155 | A-10155 | HB | 530.0817 | A-530.0817 |
| HB | 530.218 | A-530.218 | HB | 530.208 | A-530.208 |
| HB | 530.221 | A-530.221 | HB | 530.2080B2 | A-530.2080B2 |
| HB | 10158 | A-10158 | HB | 530.2081 | A-530.2081 |
| HB | 530.2038 | A-530.2038 | HB | 530.0837 | A-530.0837 |
| HB | 530.204 | A-530.204 | HB | 530.2082 | A-530.2082 |
| HB | 530.0426 | A-530.0426 | HB | 530.2083 | A-530.2083 |
| HB | 10139 | A-10139 | HB | 530.2084 | A-530.2084 |
| HB | K228 | A-K228 | HB | 530.2085 | A-530.2085 |
| HB | 13515 | A-13515 | HB | 530.0881 | A-530.0881 |
| HB | 530.2044 | A-530.2044 | HB | 10147 | A-10147 |
| HB | 530.2046 | A-530.2046 | HB | 530.209 | A-530.209 |
| HB | 13487 | A-13487 | HB | 530.0913 | A-530.0913 |



HORWOOD BAGSHAW (HB)

| OEM | OEM  Part No. | PIX  Part No. | OEM | OEM  Part No. | PIX  Part No. |
|-----|--|--|-----|--|--|
| HB | 530.2093 | A-530.2093 | HB | 520.3075 | A-520.3075 |
| HB | 530.2095 | A-530.2095 | HB | 530.0775 | A-530.0775 |
| HB | 10149 | A-10149 | HB | 530.10165 | A-530.10165 |
| HB | 0156910203 | A-0156910203 | HB | 530.3075 | A-530.3075 |
| HB | 10171 | A-10171 | HB | 530.3076 | A-530.3076 |
| HB | 530.3096 | A-530.3096 | HB | 0156910202 | A-0156910202 |
| HB | 530.3099 | A-530.3099 | HB | 10168 | A-10168 |
| HB | 10173 | A-10173 | HB | 530.08 | A-530.08 |
| HB | 0156910205 | A-0156910205 | HB | 530.3078 | A-530.3078 |
| HB | 10176 | A-10176 | HB | K1148 | A-K1148 |
| HB | 530.3112 | A-530.3112 | HB | 10169 | A-10169 |
| HB | 530.3116 | A-530.3116 | HB | K2429 | A-K2429 |
| HB | 10178 | A-10178 | HB | 530.0855 | A-530.0855 |
| HB | 530.312 | A-530.312 | HB | 530.087 | A-530.087 |
| HB | 10157 | A-10157 | HB | 13530 | A-13530 |
| HB | 530.3128 | A-530.3128 | HB | 530.3085 | A-530.3085 |
| HB | 530.3132 | A-530.3132 | HB | 530.0925 | A-530.0925 |
| HB | 0156910208 | A-0156910208 | HB | 530.309 | A-530.309 |
| HB | 10180 | A-10180 | HB | 10172 | A-10172 |
| HB | 530.1465 | A-530.1465 | HB | 530.095 | A-530.095 |
| HB | 530.3144 | A-530.3144 | HB | 530.3092 | A-530.3092 |
| HB | 0156910207 | A-0156910207 | HB | 530.3093 | A-530.3093 |
| HB | 10179 | A-10179 | HB | 0185112130 | A-0185112130 |
| HB | 10183 | A-10183 | HB | 530.11213 | A-530.11213 |
| HB | 530.3152 | A-530.3152 | HB | 1651023 | A-1651023 |
| HB | 10185 | A-10185 | HB | 10186 | A-10186 |
| HB | 530.158 | A-530.158 | HB | 14051 | A-14051 |
| HB | 530.3158 | A-530.3158 | HB | 530.0186 | A-530.0186 |
| HB | K374 | A-K374 | HB | 10146 | A-10146 |
| HB | 530.1972 | A-530.1972 | HB | 10187 | A-10187 |
| HB | 530.3162 | A-530.3162 | HB | 14053 | A-14053 |
| HB | 530.318 | A-530.318 | | | |
| HB | 530.4195 | A-530.4195 | | | |
| HB | 10189 | A-10189 | | | |
| HB | 10190 | A-10190 | | | |
| HB | 10191 | A-10191 | | | |
| HB | 530.3048 | A-530.3048 | | | |
| HB | 530.0532 | A-530.0532 | | | |
| HB | 530.3051 | A-530.3051 | | | |
| HB | 530.0605 | A-530.0605 | | | |
| HB | 10182 | A-10182 | | | |
| HB | 530.062 | A-530.062 | | | |
| HB | 530.306 | A-530.306 | | | |
| HB | 530.0657 | A-530.0657 | | | |
| HB | 530.07 | A-530.07 | | | |
| HB | 530.0725 | A-530.0725 | | | |
| HB | 530.0762 | A-530.0762 | | | |



JF FABRIKEN

| OEM | OEM  Part No. | PIX  Part No. | OEM | OEM  Part No. | PIX  Part No. |
|-------------|--|--|-------------|--|--|
| JF FABRIKEN | 13621001 | A-13621001 | JF FABRIKEN | 13616102 | A-13616102 |
| JF FABRIKEN | 13621005 | A-13621005 | JF FABRIKEN | 13619737 | A-13619737 |
| JF FABRIKEN | 13621002 | A-13621002 | JF FABRIKEN | 13629713 | A-13629713 |
| JF FABRIKEN | 13621007 | A-13621007 | JF FABRIKEN | 13629730 | A-13629730 |
| JF FABRIKEN | 13621205 | A-13621205 | JF FABRIKEN | 13629732 | A-13629732 |
| JF FABRIKEN | 13629733 | A-13629733 | JF FABRIKEN | 13618110 | A-13618110 |
| JF FABRIKEN | 13621207 | A-13621207 | JF FABRIKEN | 13622405 | A-13622405 |
| JF FABRIKEN | 13621008 | A-13621008 | JF FABRIKEN | 13622407 | A-13622407 |
| JF FABRIKEN | 13629724 | A-13629724 | JF FABRIKEN | 13613404 | A-13613404 |
| JF FABRIKEN | 13629803 | A-13629803 | JF FABRIKEN | 13614401 | A-13614401 |
| JF FABRIKEN | 13621208 | A-13621208 | JF FABRIKEN | 13614402 | A-13614402 |
| JF FABRIKEN | 13621012 | A-13621012 | JF FABRIKEN | 13614403 | A-13614403 |
| JF FABRIKEN | 13621209 | A-13621209 | JF FABRIKEN | 13615402 | A-13615402 |
| JF FABRIKEN | 13622202 | A-13622202 | JF FABRIKEN | 13615404 | A-13615404 |
| JF FABRIKEN | 13619805 | A-13619805 | JF FABRIKEN | 13615405 | A-13615405 |
| JF FABRIKEN | 13629702 | A-13629702 | JF FABRIKEN | 13616406 | A-13616406 |
| JF FABRIKEN | 13629722 | A-13629722 | JF FABRIKEN | 13619901 | A-13619901 |
| JF FABRIKEN | 13629716 | A-13629716 | JF FABRIKEN | 13616407 | A-13616407 |
| JF FABRIKEN | 13622106 | A-13622106 | JF FABRIKEN | 13616402 | A-13616402 |
| JF FABRIKEN | 13629727 | A-13629727 | JF FABRIKEN | 13616410 | A-13616410 |
| JF FABRIKEN | 13629725 | A-13629725 | JF FABRIKEN | 13616404 | A-13616404 |
| JF FABRIKEN | 13619804 | A-13619804 | JF FABRIKEN | 13616405 | A-13616405 |
| JF FABRIKEN | 13619703 | A-13619703 | JF FABRIKEN | 13616401 | A-13616401 |
| JF FABRIKEN | 13629721 | A-13629721 | JF FABRIKEN | 13619908 | A-13619908 |
| JF FABRIKEN | 13629705 | A-13629705 | JF FABRIKEN | 13617403 | A-13617403 |
| JF FABRIKEN | 13623205 | A-13623205 | JF FABRIKEN | 13618403 | A-13618403 |
| JF FABRIKEN | 13621004 | A-13621004 | JF FABRIKEN | 13618401 | A-13618401 |
| JF FABRIKEN | 13613202 | A-13613202 | JF FABRIKEN | 13619906 | A-13619906 |
| JF FABRIKEN | 13623105 | A-13623105 | JF FABRIKEN | 13618307 | A-13618307 |
| JF FABRIKEN | 13614101 | A-13614101 | JF FABRIKEN | 13628408 | A-13628408 |
| JF FABRIKEN | 13629723 | A-13629723 | JF FABRIKEN | 13618308 | A-13618308 |
| JF FABRIKEN | 13619707 | A-13619707 | JF FABRIKEN | 13618311 | A-13618311 |
| JF FABRIKEN | 13621013 | A-13621013 | JF FABRIKEN | 13618310 | A-13618310 |
| JF FABRIKEN | 13621003 | A-13621003 | JF FABRIKEN | 13624105 | A-13624105 |
| JF FABRIKEN | 13621009 | A-13621009 | JF FABRIKEN | 13618303 | A-13618303 |
| JF FABRIKEN | 13615202 | A-13615202 | JF FABRIKEN | 13618304 | A-13618304 |
| JF FABRIKEN | 13621010 | A-13621010 | JF FABRIKEN | 13618300 | A-13618300 |
| JF FABRIKEN | 13621006 | A-13621006 | JF FABRIKEN | 13619615 | A-13619615 |
| JF FABRIKEN | 13626101 | A-13626101 | JF FABRIKEN | 13619601 | A-13619601 |
| JF FABRIKEN | 13621016 | A-13621016 | JF FABRIKEN | 13619605 | A-13619605 |
| JF FABRIKEN | 13621014 | A-13621014 | JF FABRIKEN | 13619608 | A-13619608 |
| JF FABRIKEN | 13629720 | A-13629720 | JF FABRIKEN | 13615502 | A-13615502 |
| JF FABRIKEN | 13621017 | A-13621017 | JF FABRIKEN | 13615501 | A-13615501 |
| JF FABRIKEN | 13619706 | A-13619706 | JF FABRIKEN | 13616501 | A-13616501 |
| JF FABRIKEN | 13621011 | A-13621011 | JF FABRIKEN | 13617502 | A-13617502 |
| JF FABRIKEN | 13619709 | A-13619709 | JF FABRIKEN | 13628505 | A-13628505 |
| JF FABRIKEN | 13629719 | A-13629719 | JF FABRIKEN | 13618509 | A-13618509 |

HORWOOD BAGSHAW (HB)



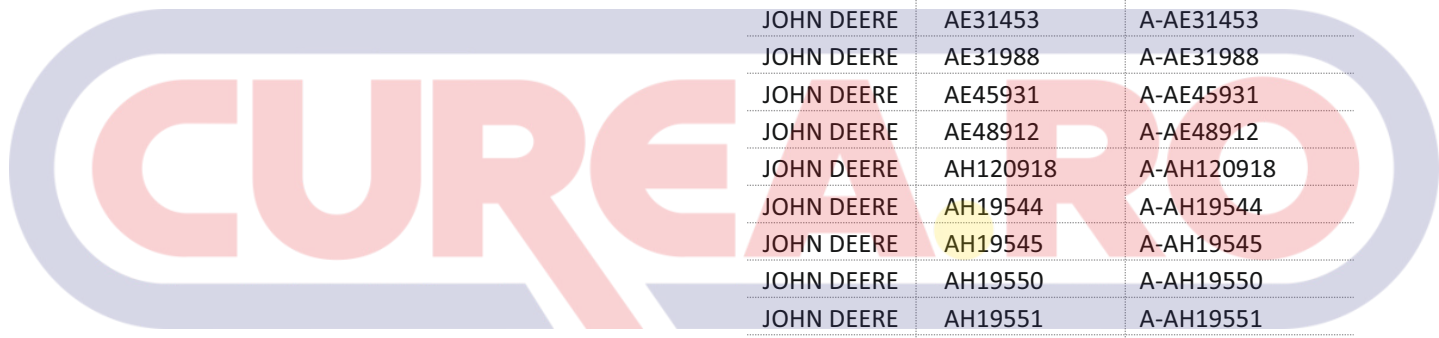

| OEM | OEM  Part No. | PIX  Part No. |
|-------------|--|--|
| JF FABRIKEN | 13618508 | A-13618508 |
| JF FABRIKEN | 13618503 | A-13618503 |
| JF FABRIKEN | 13619618 | A-13619618 |
| JF FABRIKEN | 13618511 | A-13618511 |
| JF FABRIKEN | 13618512 | A-13618512 |

JOHN DEERE





| OEM | OEM  Part No. | PIX  Part No. |
|------------|--|--|
| JOHN DEERE | 175632 | A-175632 |
| JOHN DEERE | 01145789 | A-01145789 |
| JOHN DEERE | 10VX00D | A-10VX00D |
| JOHN DEERE | 155538 | A-155538 |
| JOHN DEERE | 190040211 | A-190040211 |
| JOHN DEERE | 37473 | A-37473 |
| JOHN DEERE | 4032807792 | A-4032807792 |
| JOHN DEERE | 40745/804 | A-40745/804 |
| JOHN DEERE | 41959200 | A-41959200 |
| JOHN DEERE | 60022 | A-60022 |
| JOHN DEERE | 600A01 | A-600A01 |
| JOHN DEERE | 600A07 | A-600A07 |
| JOHN DEERE | 600A11 | A-600A11 |
| JOHN DEERE | 600A16 | A-600A16 |
| JOHN DEERE | 84012974 | A-84012974 |
| JOHN DEERE | A 121116 | A-A121116 |
| JOHN DEERE | A29343 | A-A29343 |
| JOHN DEERE | AE28944 | A-AE28944 |
| JOHN DEERE | AE31453 | A-AE31453 |
| JOHN DEERE | AE31988 | A-AE31988 |
| JOHN DEERE | AE45931 | A-AE45931 |
| JOHN DEERE | AE48912 | A-AE48912 |
| JOHN DEERE | AH120918 | A-AH120918 |
| JOHN DEERE | AH19544 | A-AH19544 |
| JOHN DEERE | AH19545 | A-AH19545 |
| JOHN DEERE | AH19550 | A-AH19550 |
| JOHN DEERE | AH19551 | A-AH19551 |
| JOHN DEERE | AH20314H | A-AH20314H |
| JOHN DEERE | AH21300 | A-AH21300 |
| JOHN DEERE | AH228935 | A-AH228935 |
| JOHN DEERE | AH232955 | A-AH232955 |
| JOHN DEERE | AH62667 | A-AH62667 |
| JOHN DEERE | AH62729 | A-AH62729 |
| JOHN DEERE | AH63075 | A-AH63075 |
| JOHN DEERE | AH75079 | A-AH75079 |
| JOHN DEERE | AH75634 | A-AH75634 |
| JOHN DEERE | AH76142 | A-AH76142 |
| JOHN DEERE | AJ58940 | A-AJ58940 |
| JOHN DEERE | AN103487 | A-AN103487 |
| JOHN DEERE | AN103488 | A-AN103488 |
| JOHN DEERE | AN150062 | A-AN150062 |
| JOHN DEERE | AN190948 | A-AN190948 |
| JOHN DEERE | AN194750 | A-AN194750 |
| JOHN DEERE | AN194751 | A-AN194751 |
| JOHN DEERE | AN194916 | A-AN194916 |
| JOHN DEERE | AN194917 | A-AN194917 |
| JOHN DEERE | AN221414 | A-AN221414 |







JOHN DEERE

| OEM | OEM  Part No. | PIX  Part No. | OEM | OEM  Part No. | PIX  Part No. |
|------------|--|--|------------|--|--|
| JOHN DEERE | AN273251 | A-AN273251 | JOHN DEERE | AZ53569 | A-AZ53569 |
| JOHN DEERE | AN273299 | A-AN273299 | JOHN DEERE | AZ53570 | A-AZ53570 |
| JOHN DEERE | AN274215 | A-AN274215 | JOHN DEERE | AZ56225 | A-AZ56225 |
| JOHN DEERE | AN274672 | A-AN274672 | JOHN DEERE | AZ58519 | A-AZ58519 |
| JOHN DEERE | AN274673 | A-AN274673 | JOHN DEERE | AZ61336 | A-AZ61336 |
| JOHN DEERE | AN373725 | A-AN373725 | JOHN DEERE | AZ61389 | A-AZ61389 |
| JOHN DEERE | AR53099 | A-AR53099 | JOHN DEERE | AZ63463 | A-AZ63463 |
| JOHN DEERE | AR57266 | A-AR57266 | JOHN DEERE | AZ63883 | A-AZ63883 |
| JOHN DEERE | AR86496 | A-AR86496 | JOHN DEERE | B13907B | A-B13907B |
| JOHN DEERE | AS22914 | A-AS22914 | JOHN DEERE | B14826B | A-B14826B |
| JOHN DEERE | AS26639 | A-AS26639 | JOHN DEERE | B17267B | A-B17267B |
| JOHN DEERE | AS33603 | A-AS33603 | JOHN DEERE | B27635 | A-B27635 |
| JOHN DEERE | AS34773 | A-AS34773 | JOHN DEERE | B28170 | A-B28170 |
| JOHN DEERE | AT23317 | A-AT23317 | JOHN DEERE | C11078C | A-C11078C |
| JOHN DEERE | AW10254 | A-AW10254 | JOHN DEERE | C12831CH | A-C12831CH |
| JOHN DEERE | AXE10456 | A-AXE10456 | JOHN DEERE | C17165 | A-C17165 |
| JOHN DEERE | AXE22550 | A-AXE22550 | JOHN DEERE | C17334 | A-C17334 |
| JOHN DEERE | AXE24473 | A-AXE24473 | JOHN DEERE | C19647 | A-C19647 |
| JOHN DEERE | AXE25334 | A-AXE25334 | JOHN DEERE | C22534 | A-C22534 |
| JOHN DEERE | AXE26321 | A-AXE26321 | JOHN DEERE | CC100317 | A-CC100317 |
| JOHN DEERE | AXE29294 | A-AXE29294 | JOHN DEERE | CC100318 | A-CC100318 |
| JOHN DEERE | AXE33418 | A-AXE33418 | JOHN DEERE | CC100752 | A-CC100752 |
| JOHN DEERE | AXE33760 | A-AXE33760 | JOHN DEERE | CC100753 | A-CC100753 |
| JOHN DEERE | AYC10131 | A-AYC10131 | JOHN DEERE | CC100754 | A-CC100754 |
| JOHN DEERE | AYC10132 | A-AYC10132 | JOHN DEERE | CC102733 | A-CC102733 |
| JOHN DEERE | AYC10133 | A-AYC10133 | JOHN DEERE | CC107199 | A-CC107199 |
| JOHN DEERE | AYC18136 | A-AYC18136 | JOHN DEERE | CC18089 | A-CC18089 |
| JOHN DEERE | AZ100806 | A-AZ100806 | JOHN DEERE | CC19065 | A-CC19065 |
| JOHN DEERE | AZ100807 | A-AZ100807 | JOHN DEERE | CC21115 | A-CC21115 |
| JOHN DEERE | AZ100808 | A-AZ100808 | JOHN DEERE | CC26949 | A-CC26949 |
| JOHN DEERE | AZ100809 | A-AZ100809 | JOHN DEERE | CC26973 | A-CC26973 |
| JOHN DEERE | AZ100810 | A-AZ100810 | JOHN DEERE | CC38627 | A-CC38627 |
| JOHN DEERE | AZ101386 | A-AZ101386 | JOHN DEERE | CC38702 | A-CC38702 |
| JOHN DEERE | AZ25400 | A-AZ25400 | JOHN DEERE | CC47554 | A-CC47554 |
| JOHN DEERE | AZ39676 | A-AZ39676 | JOHN DEERE | CH12865 | A-CH12865 |
| JOHN DEERE | AZ39677 | A-AZ39677 | JOHN DEERE | CH40793 | A-CH40793 |
| JOHN DEERE | AZ39678 | A-AZ39678 | JOHN DEERE | CM15519 | A-CM15519 |
| JOHN DEERE | AZ41136 | A-AZ41136 | JOHN DEERE | CM15520 | A-CM15520 |
| JOHN DEERE | AZ43804 | A-AZ43804 | JOHN DEERE | CQ00626 | A-CQ00626 |
| JOHN DEERE | AZ43805 | A-AZ43805 | JOHN DEERE | CQ00628 | A-CQ00628 |
| JOHN DEERE | AZ46283 | A-AZ46283 | JOHN DEERE | CQ02867 | A-CQ02867 |
| JOHN DEERE | AZ51312 | A-AZ51312 | JOHN DEERE | CQ03283 | A-CQ03283 |
| JOHN DEERE | AZ51314 | A-AZ51314 | JOHN DEERE | CQ03457 | A-CQ03457 |
| JOHN DEERE | AZ51638 | A-AZ51638 | JOHN DEERE | CQ05106 | A-CQ05106 |
| JOHN DEERE | AZ51639 | A-AZ51639 | JOHN DEERE | CQ05208 | A-CQ05208 |
| JOHN DEERE | AZ51641 | A-AZ51641 | JOHN DEERE | CQ08238 | A-CQ08238 |
| JOHN DEERE | AZ53559 | A-AZ53559 | JOHN DEERE | CQ12236 | A-CQ12236 |





JOHN DEERE

| OEM | OEM  Part No. | PIX  Part No. | OEM | OEM  Part No. | PIX  Part No. |
|------------|--|--|------------|--|--|
| JOHN DEERE | CQ13375 | A-CQ13375 | JOHN DEERE | E127010 | A-E127010 |
| JOHN DEERE | CQ13673 | A-CQ13673 | JOHN DEERE | E130084 | A-E130084 |
| JOHN DEERE | CQ13800 | A-CQ13800 | JOHN DEERE | E13664 | A-E13664 |
| JOHN DEERE | CQ24186 | A-CQ24186 | JOHN DEERE | E14507 | A-E14507 |
| JOHN DEERE | CQ24340 | A-CQ24340 | JOHN DEERE | E16774 | A-E16774 |
| JOHN DEERE | CQ33577 | A-CQ33577 | JOHN DEERE | E17465E | A-E17465E |
| JOHN DEERE | CQ33886 | A-CQ33886 | JOHN DEERE | E17844 | A-E17844 |
| JOHN DEERE | CQ34122 | A-CQ34122 | JOHN DEERE | E35829 | A-E35829 |
| JOHN DEERE | CQ34237 | A-CQ34237 | JOHN DEERE | E36311 | A-E36311 |
| JOHN DEERE | CQ35417 | A-CQ35417 | JOHN DEERE | E36784 | A-E36784 |
| JOHN DEERE | CQ35531 | A-CQ35531 | JOHN DEERE | E37644 | A-E37644 |
| JOHN DEERE | CQ35559 | A-CQ35559 | JOHN DEERE | E37821 | A-E37821 |
| JOHN DEERE | CQ40221 | A-CQ40221 | JOHN DEERE | E37905 | A-E37905 |
| JOHN DEERE | CQ45617 | A-CQ45617 | JOHN DEERE | E38587 | A-E38587 |
| JOHN DEERE | CQ48048 | A-CQ48048 | JOHN DEERE | E39526 | A-E39526 |
| JOHN DEERE | CQ50143 | A-CQ50143 | JOHN DEERE | E39739 | A-E39739 |
| JOHN DEERE | CQ50144 | A-CQ50144 | JOHN DEERE | E40574 | A-E40574 |
| JOHN DEERE | CQ51920 | A-CQ51920 | JOHN DEERE | E41055 | A-E41055 |
| JOHN DEERE | CQ51921 | A-CQ51921 | JOHN DEERE | E43565 | A-E43565 |
| JOHN DEERE | CQ53362 | A-CQ53362 | JOHN DEERE | E4461E | A-E4461E |
| JOHN DEERE | CQ53363 | A-CQ53363 | JOHN DEERE | E46113 | A-E46113 |
| JOHN DEERE | CQ53364 | A-CQ53364 | JOHN DEERE | E46806 | A-E46806 |
| JOHN DEERE | CQ53367 | A-CQ53367 | JOHN DEERE | E46844 | A-E46844 |
| JOHN DEERE | CQ53369 | A-CQ53369 | JOHN DEERE | E46847 | A-E46847 |
| JOHN DEERE | CQ53370 | A-CQ53370 | JOHN DEERE | E48060 | A-E48060 |
| JOHN DEERE | CQ53371 | A-CQ53371 | JOHN DEERE | E48063 | A-E48063 |
| JOHN DEERE | CQ53372 | A-CQ53372 | JOHN DEERE | E48310 | A-E48310 |
| JOHN DEERE | CQ57311 | A-CQ57311 | JOHN DEERE | E50237 | A-E50237 |
| JOHN DEERE | CQ58873 | A-CQ58873 | JOHN DEERE | E50873 | A-E50873 |
| JOHN DEERE | CQ58875 | A-CQ58875 | JOHN DEERE | E50924 | A-E50924 |
| JOHN DEERE | CQ62911 | A-CQ62911 | JOHN DEERE | E50973 | A-E50973 |
| JOHN DEERE | CQ62912 | A-CQ62912 | JOHN DEERE | E51284 | A-E51284 |
| JOHN DEERE | D21501 | A-D21501 | JOHN DEERE | E51727 | A-E51727 |
| JOHN DEERE | D28125 | A-D28125 | JOHN DEERE | E51728 | A-E51728 |
| JOHN DEERE | D32190 | A-D32190 | JOHN DEERE | E52638 | A-E52638 |
| JOHN DEERE | D34099 | A-D34099 | JOHN DEERE | E52646 | A-E52646 |
| JOHN DEERE | D34405 | A-D34405 | JOHN DEERE | E53108 | A-E53108 |
| JOHN DEERE | D34828 | A-D34828 | JOHN DEERE | E53936 | A-E53936 |
| JOHN DEERE | D41981000 | A-D41981000 | JOHN DEERE | E54089 | A-E54089 |
| JOHN DEERE | DMU210282 | A-DMU210282 | JOHN DEERE | E55668 | A-E55668 |
| JOHN DEERE | DMU210306 | A-DMU210306 | JOHN DEERE | E56262 | A-E56262 |
| JOHN DEERE | DMU210479 | A-DMU210479 | JOHN DEERE | E57428 | A-E57428 |
| JOHN DEERE | DQ20810 | A-DQ20810 | JOHN DEERE | E58483 | A-E58483 |
| JOHN DEERE | DQ23754 | A-DQ23754 | JOHN DEERE | E58548 | A-E58548 |
| JOHN DEERE | DQ29594 | A-DQ29594 | JOHN DEERE | E58967 | A-E58967 |
| JOHN DEERE | E12574 | A-E12574 | JOHN DEERE | E61137 | A-E61137 |
| JOHN DEERE | E126459 | A-E126459 | JOHN DEERE | E62661 | A-E62661 |





JOHN DEERE

| OEM | OEM  Part No. | PIX  Part No. | OEM | OEM  Part No. | PIX  Part No. |
|------------|--|--|------------|--|--|
| JOHN DEERE | E63036 | A-E63036 | JOHN DEERE | H152146 | A-H 152146 |
| JOHN DEERE | E63457 | A-E63457 | JOHN DEERE | H154723 | A-H 154723 |
| JOHN DEERE | E63957 | A-E63957 | JOHN DEERE | H156541 | A-H 156541 |
| JOHN DEERE | E65863 | A-E65863 | JOHN DEERE | H160654 | A-H 160654 |
| JOHN DEERE | E69424 | A-E69424 | JOHN DEERE | H166077 | A-H 166077 |
| JOHN DEERE | E69465 | A-E69465 | JOHN DEERE | H171386 | A-H 171386 |
| JOHN DEERE | E69644 | A-E69644 | JOHN DEERE | H177178 | A-H 177178 |
| JOHN DEERE | E70357 | A-E70357 | JOHN DEERE | H202646 | A-H 202646 |
| JOHN DEERE | E70675 | A-E70675 | JOHN DEERE | H210476 | A-H 210476 |
| JOHN DEERE | E72331 | A-E72331 | JOHN DEERE | H211581 | A-H 211581 |
| JOHN DEERE | E72435 | A-E72435 | JOHN DEERE | H213353 | A-H 213353 |
| JOHN DEERE | E72830 | A-E72830 | JOHN DEERE | H218645 | A-H 218645 |
| JOHN DEERE | E75432 | A-E75432 | JOHN DEERE | H220911 | A-H 220911 |
| JOHN DEERE | E75596 | A-E75596 | JOHN DEERE | H221273 | A-H 221273 |
| JOHN DEERE | E76308 | A-E76308 | JOHN DEERE | H235564 | A-H 235564 |
| JOHN DEERE | E78277 | A-E78277 | JOHN DEERE | H238867 | A-H 238867 |
| JOHN DEERE | E79089 | A-E79089 | JOHN DEERE | HHH10556 | A-H Hh10556 |
| JOHN DEERE | E79907 | A-E79907 | JOHN DEERE | H105040 | A-H105040 |
| JOHN DEERE | E81146 | A-E81146 | JOHN DEERE | H113759 | A-H113759 |
| JOHN DEERE | E81147 | A-E81147 | JOHN DEERE | H132665 | A-H132665 |
| JOHN DEERE | E81892 | A-E81892 | JOHN DEERE | H135417 | A-H135417 |
| JOHN DEERE | E81907 | A-E81907 | JOHN DEERE | H136881 | A-H136881 |
| JOHN DEERE | E83737 | A-E83737 | JOHN DEERE | H136963 | A-H136963 |
| JOHN DEERE | E83777 | A-E83777 | JOHN DEERE | H137224 | A-H137224 |
| JOHN DEERE | E88931 | A-E88931 | JOHN DEERE | H138761 | A-H138761 |
| JOHN DEERE | E91269 | A-E91269 | JOHN DEERE | H139436 | A-H139436 |
| JOHN DEERE | E91575 | A-E91575 | JOHN DEERE | H140623 | A-H140623 |
| JOHN DEERE | EP0020 | A-EP0020 | JOHN DEERE | H145517 | A-H145517 |
| JOHN DEERE | EPC201624 | A-EPC201624 | JOHN DEERE | H145528 | A-H145528 |
| JOHN DEERE | FH10164 | A-FH10164 | JOHN DEERE | H155525 | A-H155525 |
| JOHN DEERE | FH10165 | A-FH10165 | JOHN DEERE | H156863 | A-H156863 |
| JOHN DEERE | FH305097 | A-FH305097 | JOHN DEERE | H157727 | A-H157727 |
| JOHN DEERE | FH318412 | A-FH318412 | JOHN DEERE | H158512 | A-H158512 |
| JOHN DEERE | G6876E | A-G6876E | JOHN DEERE | H160080 | A-H160080 |
| JOHN DEERE | GMJ1341 | A-GMJ1341 | JOHN DEERE | H160831 | A-H160831 |
| JOHN DEERE | GMJ1342 | A-GMJ1342 | JOHN DEERE | H161339 | A-H161339 |
| JOHN DEERE | GMJC19065 | A-GMJC19065 | JOHN DEERE | H161945 | A-H161945 |
| JOHN DEERE | GMJC21115 | A-GMJC21115 | JOHN DEERE | H162310 | A-H162310 |
| JOHN DEERE | GMJC26949 | A-GMJC26949 | JOHN DEERE | H162727 | A-H162727 |
| JOHN DEERE | GMJC26973 | A-GMJC26973 | JOHN DEERE | H163106 | A-H163106 |
| JOHN DEERE | GX10062 | A-GX10062 | JOHN DEERE | H163576 | A-H163576 |
| JOHN DEERE | GX10064 | A-GX10064 | JOHN DEERE | H164368 | A-H164368 |
| JOHN DEERE | GX20072 | A-GX20072 | JOHN DEERE | H164870 | A-H164870 |
| JOHN DEERE | GX21833 | A-GX21833 | JOHN DEERE | H165015 | A-H165015 |
| JOHN DEERE | H115881 | A-H 115881 | JOHN DEERE | H165708 | A-H165708 |
| JOHN DEERE | H131169 | A-H 131169 | JOHN DEERE | H166077 | A-H166077 |
| JOHN DEERE | H146636 | A-H 146636 | JOHN DEERE | H166457 | A-H166457 |





JOHN DEERE

| OEM | OEM  Part No. | PIX  Part No. | OEM | OEM  Part No. | PIX  Part No. |
|------------|--|--|------------|--|--|
| JOHN DEERE | H170047 | A-H170047 | JOHN DEERE | H227098 | A-H227098 |
| JOHN DEERE | H172610 | A-H172610 | JOHN DEERE | H228250 | A-H228250 |
| JOHN DEERE | H173832 | A-H173832 | JOHN DEERE | H228260 | A-H228260 |
| JOHN DEERE | H174367 | A-H174367 | JOHN DEERE | H228261 | A-H228261 |
| JOHN DEERE | H174456 | A-H174456 | JOHN DEERE | H228346 | A-H228346 |
| JOHN DEERE | H174457 | A-H174457 | JOHN DEERE | H228347 | A-H228347 |
| JOHN DEERE | H175631 | A-H175631 | JOHN DEERE | H228348 | A-H228348 |
| JOHN DEERE | H175742 | A-H175742 | JOHN DEERE | H228523 | A-H228523 |
| JOHN DEERE | H176536 | A-H176536 | JOHN DEERE | H229882 | A-H229882 |
| JOHN DEERE | H177186 | A-H177186 | JOHN DEERE | H23178 | A-H23178 |
| JOHN DEERE | H177263 | A-H177263 | JOHN DEERE | H232237 | A-H232237 |
| JOHN DEERE | H177887 | A-H177887 | JOHN DEERE | H232394 | A-H232394 |
| JOHN DEERE | H178037 | A-H178037 | JOHN DEERE | H23725 | A-H23725 |
| JOHN DEERE | H178757 | A-H178757 | JOHN DEERE | H23766 | A-H23766 |
| JOHN DEERE | H201794 | A-H201794 | JOHN DEERE | H23770 | A-H23770 |
| JOHN DEERE | H201851 | A-H201851 | JOHN DEERE | H23771 | A-H23771 |
| JOHN DEERE | H201916 | A-H201916 | JOHN DEERE | H238679 | A-H238679 |
| JOHN DEERE | H202646 | A-H202646 | JOHN DEERE | H238869 | A-H238869 |
| JOHN DEERE | H202647 | A-H202647 | JOHN DEERE | H238870 | A-H238870 |
| JOHN DEERE | H20406 | A-H20406 | JOHN DEERE | H238871 | A-H238871 |
| JOHN DEERE | H205240 | A-H205240 | JOHN DEERE | H240885 | A-H240885 |
| JOHN DEERE | H210001 | A-H210001 | JOHN DEERE | H24472 | A-H24472 |
| JOHN DEERE | H210003 | A-H210003 | JOHN DEERE | H24650 | A-H24650 |
| JOHN DEERE | H211763 | A-H211763 | JOHN DEERE | H24984 | A-H24984 |
| JOHN DEERE | H211764 | A-H211764 | JOHN DEERE | H25151 | A-H25151 |
| JOHN DEERE | H21233 | A-H21233 | JOHN DEERE | H25641 | A-H25641 |
| JOHN DEERE | H214375 | A-H214375 | JOHN DEERE | H25642H | A-H25642H |
| JOHN DEERE | H216026 | A-H216026 | JOHN DEERE | H25647 | A-H25647 |
| JOHN DEERE | H21666 | A-H21666 | JOHN DEERE | H26201H | A-H26201H |
| JOHN DEERE | H217141 | A-H217141 | JOHN DEERE | H27387 | A-H27387 |
| JOHN DEERE | H218197 | A-H218197 | JOHN DEERE | H27527 | A-H27527 |
| JOHN DEERE | H218198 | A-H218198 | JOHN DEERE | H27568 | A-H27568 |
| JOHN DEERE | H21882 | A-H21882 | JOHN DEERE | H27955 | A-H27955 |
| JOHN DEERE | H21925 | A-H21925 | JOHN DEERE | H28671 | A-H28671 |
| JOHN DEERE | H21929H | A-H21929H | JOHN DEERE | H28682 | A-H28682 |
| JOHN DEERE | H220051 | A-H220051 | JOHN DEERE | H28705 | A-H28705 |
| JOHN DEERE | H220052 | A-H220052 | JOHN DEERE | H28708 | A-H28708 |
| JOHN DEERE | H220053 | A-H220053 | JOHN DEERE | H28770 | A-H28770 |
| JOHN DEERE | H220884 | A-H220884 | JOHN DEERE | H29194 | A-H29194 |
| JOHN DEERE | H221324 | A-H221324 | JOHN DEERE | H31227 | A-H31227 |
| JOHN DEERE | H221327 | A-H221327 | JOHN DEERE | H31267 | A-H31267 |
| JOHN DEERE | H223384 | A-H223384 | JOHN DEERE | H31328 | A-H31328 |
| JOHN DEERE | H223916 | A-H223916 | JOHN DEERE | H31329 | A-H31329 |
| JOHN DEERE | H223917 | A-H223917 | JOHN DEERE | H31330 | A-H31330 |
| JOHN DEERE | H224184 | A-H224184 | JOHN DEERE | H31966 | A-H31966 |
| JOHN DEERE | H224185 | A-H224185 | JOHN DEERE | H32099 | A-H32099 |
| JOHN DEERE | H225035 | A-H225035 | JOHN DEERE | H32118 | A-H32118 |





JOHN DEERE

| OEM | OEM  Part No. | PIX  Part No. | OEM | OEM  Part No. | PIX  Part No. |
|------------|--|--|------------|--|--|
| JOHN DEERE | H32801 | A-H32801 | JOHN DEERE | H91814 | A-H91814 |
| JOHN DEERE | H32802 | A-H32802 | JOHN DEERE | H92080 | A-H92080 |
| JOHN DEERE | H33142 | A-H33142 | JOHN DEERE | H94254 | A-H94254 |
| JOHN DEERE | H33311 | A-H33311 | JOHN DEERE | H94508 | A-H94508 |
| JOHN DEERE | H33312 | A-H33312 | JOHN DEERE | H96248 | A-H96248 |
| JOHN DEERE | H33313 | A-H33313 | JOHN DEERE | H97652 | A-H97652 |
| JOHN DEERE | H33314 | A-H33314 | JOHN DEERE | H97692 | A-H97692 |
| JOHN DEERE | H33473 | A-H33473 | JOHN DEERE | H99515 | A-H99515 |
| JOHN DEERE | H33695 | A-H33695 | JOHN DEERE | HXE10785 | A-HXE10785 |
| JOHN DEERE | H34740 | A-H34740 | JOHN DEERE | HXE11255 | A-HXE11255 |
| JOHN DEERE | H34944 | A-H34944 | JOHN DEERE | HXE13951 | A-HXE13951 |
| JOHN DEERE | H35055 | A-H35055 | JOHN DEERE | HXE13957 | A-HXE13957 |
| JOHN DEERE | H35434 | A-H35434 | JOHN DEERE | HXE16940 | A-HXE16940 |
| JOHN DEERE | H35666 | A-H35666 | JOHN DEERE | HXE17071 | A-HXE17071 |
| JOHN DEERE | H35680 | A-H35680 | JOHN DEERE | HXE17164 | A-HXE17164 |
| JOHN DEERE | H35996 | A-H35996 | JOHN DEERE | HXE19401 | A-HXE19401 |
| JOHN DEERE | H35997 | A-H35997 | JOHN DEERE | HXE22087 | A-HXE22087 |
| JOHN DEERE | H35998 | A-H35998 | JOHN DEERE | HXE24210 | A-HXE24210 |
| JOHN DEERE | H62560 | A-H62560 | JOHN DEERE | HXE24687 | A-HXE24687 |
| JOHN DEERE | H62619 | A-H62619 | JOHN DEERE | HXE24688 | A-HXE24688 |
| JOHN DEERE | H62899 | A-H62899 | JOHN DEERE | HXE28843 | A-HXE28843 |
| JOHN DEERE | H63010 | A-H63010 | JOHN DEERE | HXE29021 | A-HXE29021 |
| JOHN DEERE | H63370 | A-H63370 | JOHN DEERE | HXE32806 | A-HXE32806 |
| JOHN DEERE | H63938 | A-H63938 | JOHN DEERE | HXE34473 | A-HXE34473 |
| JOHN DEERE | H63939 | A-H63939 | JOHN DEERE | HXE34567 | A-HXE34567 |
| JOHN DEERE | H64206 | A-H64206 | JOHN DEERE | HXE35822 | A-HXE35822 |
| JOHN DEERE | H64483 | A-H64483 | JOHN DEERE | HXE35957 | A-HXE35957 |
| JOHN DEERE | H64484 | A-H64484 | JOHN DEERE | HXE35958 | A-HXE35958 |
| JOHN DEERE | H64834 | A-H64834 | JOHN DEERE | HXE38000 | A-HXE38000 |
| JOHN DEERE | H64913 | A-H64913 | JOHN DEERE | HXE39119 | A-HXE39119 |
| JOHN DEERE | H75285 | A-H75285 | JOHN DEERE | HXE39397 | A-HXE39397 |
| JOHN DEERE | H75845 | A-H75845 | JOHN DEERE | HXE41402 | A-HXE41402 |
| JOHN DEERE | H76378 | A-H76378 | JOHN DEERE | HXE43428 | A-HXE43428 |
| JOHN DEERE | H77021 | A-H77021 | JOHN DEERE | HXE44273 | A-HXE44273 |
| JOHN DEERE | H77291 | A-H77291 | JOHN DEERE | HXE45928 | A-HXE45928 |
| JOHN DEERE | H79073 | A-H79073 | JOHN DEERE | HXE46515 | A-HXE46515 |
| JOHN DEERE | H79795 | A-H79795 | JOHN DEERE | HXE95935 | A-HXE95935 |
| JOHN DEERE | H81171 | A-H81171 | JOHN DEERE | J0019028 | A-J0019028 |
| JOHN DEERE | H81975 | A-H81975 | JOHN DEERE | J17878 | A-J17878 |
| JOHN DEERE | H81976 | A-H81976 | JOHN DEERE | J18038 | A-J18038 |
| JOHN DEERE | H81977 | A-H81977 | JOHN DEERE | J18470 | A-J18470 |
| JOHN DEERE | H84236 | A-H84236 | JOHN DEERE | J18477 | A-J18477 |
| JOHN DEERE | H84422 | A-H84422 | JOHN DEERE | J18796 | A-J18796 |
| JOHN DEERE | H86017 | A-H86017 | JOHN DEERE | J19214 | A-J19214 |
| JOHN DEERE | H86059 | A-H86059 | JOHN DEERE | J20475 | A-J20475 |
| JOHN DEERE | H87256 | A-H87256 | JOHN DEERE | J57007 | A-J57007 |
| JOHN DEERE | H88455 | A-H88455 | JOHN DEERE | J57065 | A-J57065 |





JOHN DEERE

| OEM | OEM  Part No. | PIX  Part No. | OEM | OEM  Part No. | PIX  Part No. |
|------------|--|--|------------|--|--|
| JOHN DEERE | J57234 | A-J57234 | JOHN DEERE | L155538 | A-L155538 |
| JOHN DEERE | JDE61326 | A-JDE61326 | JOHN DEERE | L155538V | A-L155538V |
| JOHN DEERE | L101166 | A-L101166 | JOHN DEERE | L166309 | A-L166309 |
| JOHN DEERE | L101411 | A-L101411 | JOHN DEERE | L169272 | A-L169272 |
| JOHN DEERE | L110391 | A-L110391 | JOHN DEERE | L169273 | A-L169273 |
| JOHN DEERE | L110599 | A-L110599 | JOHN DEERE | L169990 | A-L169990 |
| JOHN DEERE | L11060 | A-L11060 | JOHN DEERE | L1711 | A-L1711 |
| JOHN DEERE | L110600 | A-L110600 | JOHN DEERE | L172523 | A-L172523 |
| JOHN DEERE | L110602 | A-L110602 | JOHN DEERE | L1887 | A-L1887 |
| JOHN DEERE | L110603 | A-L110603 | JOHN DEERE | L1888 | A-L1888 |
| JOHN DEERE | L110605 | A-L110605 | JOHN DEERE | L1890C | A-L1890C |
| JOHN DEERE | L110606 | A-L110606 | JOHN DEERE | L1894 | A-L1894 |
| JOHN DEERE | L110607 | A-L110607 | JOHN DEERE | L1899 | A-L1899 |
| JOHN DEERE | L110608 | A-L110608 | JOHN DEERE | L200916 | A-L200916 |
| JOHN DEERE | L110609 | A-L110609 | JOHN DEERE | L201806 | A-L201806 |
| JOHN DEERE | L111087 | A-L111087 | JOHN DEERE | L202229 | A-L202229 |
| JOHN DEERE | L1111 | A-L1111 | JOHN DEERE | L202230 | A-L202230 |
| JOHN DEERE | L111148 | A-L111148 | JOHN DEERE | L203293 | A-L203293 |
| JOHN DEERE | L111169 | A-L111169 | JOHN DEERE | L203294 | A-L203294 |
| JOHN DEERE | L111170 | A-L111170 | JOHN DEERE | L203295 | A-L203295 |
| JOHN DEERE | L111600 | A-L111600 | JOHN DEERE | L203299 | A-L203299 |
| JOHN DEERE | L111601 | A-L111601 | JOHN DEERE | L203300 | A-L203300 |
| JOHN DEERE | L111602 | A-L111602 | JOHN DEERE | L203302 | A-L203302 |
| JOHN DEERE | L111685 | A-L111685 | JOHN DEERE | L203305 | A-L203305 |
| JOHN DEERE | L111801 | A-L111801 | JOHN DEERE | L203306 | A-L203306 |
| JOHN DEERE | L111804 | A-L111804 | JOHN DEERE | L203307 | A-L203307 |
| JOHN DEERE | L111933 | A-L111933 | JOHN DEERE | L213022 | A-L213022 |
| JOHN DEERE | L114286 | A-L114286 | JOHN DEERE | L213023 | A-L213023 |
| JOHN DEERE | L114290 | A-L114290 | JOHN DEERE | L2217 | A-L2217 |
| JOHN DEERE | L114292 | A-L114292 | JOHN DEERE | L3700 | A-L3700 |
| JOHN DEERE | L114293 | A-L114293 | JOHN DEERE | L41330 | A-L41330 |
| JOHN DEERE | L114468 | A-L114468 | JOHN DEERE | L41331 | A-L41331 |
| JOHN DEERE | L114487 | A-L114487 | JOHN DEERE | L4319N | A-L4319N |
| JOHN DEERE | L114488 | A-L114488 | JOHN DEERE | L4339 | A-L4339 |
| JOHN DEERE | L114489 | A-L114489 | JOHN DEERE | L4339N | A-L4339N |
| JOHN DEERE | L115657 | A-L115657 | JOHN DEERE | L4490N | A-L4490N |
| JOHN DEERE | L115658 | A-L115658 | JOHN DEERE | L59206 | A-L59206 |
| JOHN DEERE | L115659 | A-L115659 | JOHN DEERE | L64175 | A-L64175 |
| JOHN DEERE | L115660 | A-L115660 | JOHN DEERE | L64406 | A-L64406 |
| JOHN DEERE | L115661 | A-L115661 | JOHN DEERE | L79344 | A-L79344 |
| JOHN DEERE | L1293 | A-L1293 | JOHN DEERE | L79943 | A-L79943 |
| JOHN DEERE | L1305 | A-L1305 | JOHN DEERE | L79945 | A-L79945 |
| JOHN DEERE | L1323 | A-L1323 | JOHN DEERE | LVU11659 | A-LVU11659 |
| JOHN DEERE | L1328 | A-L1328 | JOHN DEERE | M117608 | A-M117608 |
| JOHN DEERE | L153280 | A-L153280 | JOHN DEERE | M118756 | A-M118756 |
| JOHN DEERE | L153281 | A-L153281 | JOHN DEERE | M119872 | A-M119872 |
| JOHN DEERE | L153282 | A-L153282 | JOHN DEERE | M120381 | A-M120381 |





JOHN DEERE

| OEM | OEM  Part No. | PIX  Part No. | OEM | OEM  Part No. | PIX  Part No. |
|------------|--|--|------------|--|--|
| JOHN DEERE | M122075 | A-M122075 | JOHN DEERE | N121116 | A-N121116 |
| JOHN DEERE | M125383 | A-M125383 | JOHN DEERE | N121235 | A-N121235 |
| JOHN DEERE | M140502 | A-M140502 | JOHN DEERE | N121448 | A-N121448 |
| JOHN DEERE | M141627 | A-M141627 | JOHN DEERE | N121874 | A-N121874 |
| JOHN DEERE | M142997 | A-M142997 | JOHN DEERE | N123657 | A-N123657 |
| JOHN DEERE | M143019 | A-M143019 | JOHN DEERE | N124017 | A-N124017 |
| JOHN DEERE | M143888 | A-M143888 | JOHN DEERE | N124460 | A-N124460 |
| JOHN DEERE | M147278 | A-M147278 | JOHN DEERE | N125041 | A-N125041 |
| JOHN DEERE | M148556 | A-M148556 | JOHN DEERE | N12551 | A-N12551 |
| JOHN DEERE | M154157 | A-M154157 | JOHN DEERE | N128466 | A-N128466 |
| JOHN DEERE | M154295 | A-M154295 | JOHN DEERE | N128930 | A-N128930 |
| JOHN DEERE | M154897 | A-M154897 | JOHN DEERE | N129508 | A-N129508 |
| JOHN DEERE | M155368 | A-M155368 | JOHN DEERE | N129916 | A-N129916 |
| JOHN DEERE | M1900T | A-M1900T | JOHN DEERE | N129955 | A-N129955 |
| JOHN DEERE | M40223 | A-M40223 | JOHN DEERE | N150166 | A-N150166 |
| JOHN DEERE | M41592 | A-M41592 | JOHN DEERE | N150864 | A-N150864 |
| JOHN DEERE | M41642 | A-M41642 | JOHN DEERE | N15200 | A-N15200 |
| JOHN DEERE | M42485 | A-M42485 | JOHN DEERE | N15201 | A-N15201 |
| JOHN DEERE | M43569 | A-M43569 | JOHN DEERE | N15202 | A-N15202 |
| JOHN DEERE | M44121 | A-M44121 | JOHN DEERE | N153524 | A-N153524 |
| JOHN DEERE | M44272 | A-M44272 | JOHN DEERE | N154241 | A-N154241 |
| JOHN DEERE | M72031 | A-M72031 | JOHN DEERE | N15527 | A-N15527 |
| JOHN DEERE | M77988 | A-M77988 | JOHN DEERE | N15528 | A-N15528 |
| JOHN DEERE | M82462 | A-M82462 | JOHN DEERE | N15697 | A-N15697 |
| JOHN DEERE | M82538 | A-M82538 | JOHN DEERE | N157368 | A-N157368 |
| JOHN DEERE | M82720 | A-M82720 | JOHN DEERE | N157369 | A-N157369 |
| JOHN DEERE | N10068 | A-N10068 | JOHN DEERE | N15898 | A-N15898 |
| JOHN DEERE | N101027 | A-N101027 | JOHN DEERE | N170856 | A-N170856 |
| JOHN DEERE | N10192 | A-N10192 | JOHN DEERE | N174442 | A-N174442 |
| JOHN DEERE | N105015 | A-N105015 | JOHN DEERE | N190043 | A-N190043 |
| JOHN DEERE | N105016 | A-N105016 | JOHN DEERE | N193822 | A-N193822 |
| JOHN DEERE | N107439 | A-N107439 | JOHN DEERE | N202856 | A-N202856 |
| JOHN DEERE | N110051 | A-N110051 | JOHN DEERE | N210577 | A-N210577 |
| JOHN DEERE | N11057 | A-N11057 | JOHN DEERE | N220907 | A-N220907 |
| JOHN DEERE | N11117 | A-N11117 | JOHN DEERE | N221266 | A-N221266 |
| JOHN DEERE | N111527 | A-N111527 | JOHN DEERE | N221269 | A-N221269 |
| JOHN DEERE | N113642 | A-N113642 | JOHN DEERE | N222344 | A-N222344 |
| JOHN DEERE | N115368 | A-N115368 | JOHN DEERE | N223125 | A-N223125 |
| JOHN DEERE | N117398 | A-N117398 | JOHN DEERE | N274995 | A-N274995 |
| JOHN DEERE | N117674 | A-N117674 | JOHN DEERE | N30716 | A-N30716 |
| JOHN DEERE | N119624 | A-N119624 | JOHN DEERE | N310738 | A-N310738 |
| JOHN DEERE | N120086 | A-N120086 | JOHN DEERE | N31193 | A-N31193 |
| JOHN DEERE | N120289 | A-N120289 | JOHN DEERE | N31233 | A-N31233 |
| JOHN DEERE | N120715 | A-N120715 | JOHN DEERE | N31437 | A-N31437 |
| JOHN DEERE | N120717 | A-N120717 | JOHN DEERE | N31649 | A-N31649 |
| JOHN DEERE | N121113 | A-N121113 | JOHN DEERE | N32249 | A-N32249 |
| JOHN DEERE | N121114 | A-N121114 | JOHN DEERE | N33746 | A-N33746 |





JOHN DEERE

| OEM | OEM  Part No. | PIX  Part No. | OEM | OEM  Part No. | PIX  Part No. |
|------------|--|--|------------|--|--|
| JOHN DEERE | N34820 | A-N34820 | JOHN DEERE | R116492 | A-R116492 |
| JOHN DEERE | N34821 | A-N34821 | JOHN DEERE | R118317 | A-R118317 |
| JOHN DEERE | N34881 | A-N34881 | JOHN DEERE | R118318 | A-R118318 |
| JOHN DEERE | N35158 | A-N35158 | JOHN DEERE | R120524 | A-R120524 |
| JOHN DEERE | N371322 | A-N371322 | JOHN DEERE | R120852 | A-R120852 |
| JOHN DEERE | N372967 | A-N372967 | JOHN DEERE | R122126 | A-R122126 |
| JOHN DEERE | N374493 | A-N374493 | JOHN DEERE | R123292 | A-R123292 |
| JOHN DEERE | N376377 | A-N376377 | JOHN DEERE | R123293 | A-R123293 |
| JOHN DEERE | N377281 | A-N377281 | JOHN DEERE | R123294 | A-R123294 |
| JOHN DEERE | N378575 | A-N378575 | JOHN DEERE | R123296 | A-R123296 |
| JOHN DEERE | N51225 | A-N51225 | JOHN DEERE | R123306 | A-R123306 |
| JOHN DEERE | N51288 | A-N51288 | JOHN DEERE | R123307 | A-R123307 |
| JOHN DEERE | P25217 | A-P25217 | JOHN DEERE | R123308 | A-R123308 |
| JOHN DEERE | P35760 | A-P35760 | JOHN DEERE | R123432 | A-R123432 |
| JOHN DEERE | P40017 | A-P40017 | JOHN DEERE | R123436 | A-R123436 |
| JOHN DEERE | P40023 | A-P40023 | JOHN DEERE | R123437 | A-R123437 |
| JOHN DEERE | P40058H | A-P40058H | JOHN DEERE | R123438 | A-R123438 |
| JOHN DEERE | P40278 | A-P40278 | JOHN DEERE | R123441 | A-R123441 |
| JOHN DEERE | P40281 | A-P40281 | JOHN DEERE | R123442 | A-R123442 |
| JOHN DEERE | P41561 | A-P41561 | JOHN DEERE | R123445 | A-R123445 |
| JOHN DEERE | P43323 | A-P43323 | JOHN DEERE | R123449 | A-R123449 |
| JOHN DEERE | P47192 | A-P47192 | JOHN DEERE | R123450 | A-R123450 |
| JOHN DEERE | P47397 | A-P47397 | JOHN DEERE | R123453 | A-R123453 |
| JOHN DEERE | P48084 | A-P48084 | JOHN DEERE | R123456 | A-R123456 |
| JOHN DEERE | P49414 | A-P49414 | JOHN DEERE | R123457 | A-R123457 |
| JOHN DEERE | P49603 | A-P49603 | JOHN DEERE | R123458 | A-R123458 |
| JOHN DEERE | P49938 | A-P49938 | JOHN DEERE | R123459 | A-R123459 |
| JOHN DEERE | P50749 | A-P50749 | JOHN DEERE | R123460 | A-R123460 |
| JOHN DEERE | P51165 | A-P51165 | JOHN DEERE | R123462 | A-R123462 |
| JOHN DEERE | P55377 | A-P55377 | JOHN DEERE | R123463 | A-R123463 |
| JOHN DEERE | PT9483 | A-PT9483 | JOHN DEERE | R123464 | A-R123464 |
| JOHN DEERE | R101069 | A-R101069 | JOHN DEERE | R123465 | A-R123465 |
| JOHN DEERE | R106120 | A-R106120 | JOHN DEERE | R123466 | A-R123466 |
| JOHN DEERE | R106120V | A-R106120V | JOHN DEERE | R123468 | A-R123468 |
| JOHN DEERE | R106120V | A-R106120V | JOHN DEERE | R123469 | A-R123469 |
| JOHN DEERE | R106122 | A-R106122 | JOHN DEERE | R123470 | A-R123470 |
| JOHN DEERE | R106123 | A-R106123 | JOHN DEERE | R123522 | A-R123522 |
| JOHN DEERE | R107324 | A-R107324 | JOHN DEERE | R124785 | A-R124785 |
| JOHN DEERE | R108842 | A-R108842 | JOHN DEERE | R124786 | A-R124786 |
| JOHN DEERE | R111090 | A-R111090 | JOHN DEERE | R125361 | A-R125361 |
| JOHN DEERE | R115257 | A-R115257 | JOHN DEERE | R125752 | A-R125752 |
| JOHN DEERE | R115614 | A-R115614 | JOHN DEERE | R128196 | A-R128196 |
| JOHN DEERE | R115614V | A-R115614V | JOHN DEERE | R128197 | A-R128197 |
| JOHN DEERE | R115614V | A-R115614V | JOHN DEERE | R128198 | A-R128198 |
| JOHN DEERE | R115935 | A-R115935 | JOHN DEERE | R128199 | A-R128199 |
| JOHN DEERE | R115936 | A-R115936 | JOHN DEERE | R128200 | A-R128200 |
| JOHN DEERE | R116307 | A-R116307 | JOHN DEERE | R128201 | A-R128201 |





JOHN DEERE

| OEM | OEM  Part No. | PIX  Part No. | OEM | OEM  Part No. | PIX  Part No. |
|------------|--|--|------------|--|--|
| JOHN DEERE | R128202 | A-R128202 | JOHN DEERE | R134631 | A-R134631 |
| JOHN DEERE | R128203 | A-R128203 | JOHN DEERE | R134632 | A-R134632 |
| JOHN DEERE | R128204 | A-R128204 | JOHN DEERE | R134634 | A-R134634 |
| JOHN DEERE | R128205 | A-R128205 | JOHN DEERE | R134635 | A-R134635 |
| JOHN DEERE | R128206 | A-R128206 | JOHN DEERE | R134636 | A-R134636 |
| JOHN DEERE | R128208 | A-R128208 | JOHN DEERE | R134637 | A-R134637 |
| JOHN DEERE | R128209 | A-R128209 | JOHN DEERE | R134638 | A-R134638 |
| JOHN DEERE | R128210 | A-R128210 | JOHN DEERE | R135169 | A-R135169 |
| JOHN DEERE | R128502 | A-R128502 | JOHN DEERE | R135188 | A-R135188 |
| JOHN DEERE | R128806 | A-R128806 | JOHN DEERE | R135189 | A-R135189 |
| JOHN DEERE | R129083 | A-R129083 | JOHN DEERE | R135192 | A-R135192 |
| JOHN DEERE | R129738 | A-R129738 | JOHN DEERE | R135193 | A-R135193 |
| JOHN DEERE | R130478 | A-R130478 | JOHN DEERE | R135194 | A-R135194 |
| JOHN DEERE | R130852 | A-R130852 | JOHN DEERE | R135195 | A-R135195 |
| JOHN DEERE | R130889 | A-R130889 | JOHN DEERE | R135198 | A-R135198 |
| JOHN DEERE | R130899 | A-R130899 | JOHN DEERE | R135199 | A-R135199 |
| JOHN DEERE | R131083 | A-R131083 | JOHN DEERE | R135200 | A-R135200 |
| JOHN DEERE | R131213 | A-R131213 | JOHN DEERE | R135438 | A-R135438 |
| JOHN DEERE | R131213 | A-R131213 | JOHN DEERE | R135568 | A-R135568 |
| JOHN DEERE | R131433 | A-R131433 | JOHN DEERE | R135589 | A-R135589 |
| JOHN DEERE | R131434 | A-R131434 | JOHN DEERE | R135590 | A-R135590 |
| JOHN DEERE | R131436 | A-R131436 | JOHN DEERE | R135591 | A-R135591 |
| JOHN DEERE | R132159 | A-R132159 | JOHN DEERE | R135592 | A-R135592 |
| JOHN DEERE | R132925 | A-R132925 | JOHN DEERE | R135593 | A-R135593 |
| JOHN DEERE | R133402 | A-R133402 | JOHN DEERE | R135594 | A-R135594 |
| JOHN DEERE | R133518 | A-R133518 | JOHN DEERE | R135595 | A-R135595 |
| JOHN DEERE | R133693 | A-R133693 | JOHN DEERE | R135596 | A-R135596 |
| JOHN DEERE | R133694 | A-R133694 | JOHN DEERE | R135597 | A-R135597 |
| JOHN DEERE | R133695 | A-R133695 | JOHN DEERE | R135598 | A-R135598 |
| JOHN DEERE | R133696 | A-R133696 | JOHN DEERE | R135599 | A-R135599 |
| JOHN DEERE | R133697 | A-R133697 | JOHN DEERE | R135600 | A-R135600 |
| JOHN DEERE | R133699 | A-R133699 | JOHN DEERE | R135601 | A-R135601 |
| JOHN DEERE | R133700 | A-R133700 | JOHN DEERE | R135602 | A-R135602 |
| JOHN DEERE | R133701 | A-R133701 | JOHN DEERE | R135603 | A-R135603 |
| JOHN DEERE | R133702 | A-R133702 | JOHN DEERE | R135604 | A-R135604 |
| JOHN DEERE | R133703 | A-R133703 | JOHN DEERE | R135605 | A-R135605 |
| JOHN DEERE | R133704 | A-R133704 | JOHN DEERE | R135607 | A-R135607 |
| JOHN DEERE | R133705 | A-R133705 | JOHN DEERE | R135608 | A-R135608 |
| JOHN DEERE | R133706 | A-R133706 | JOHN DEERE | R135611 | A-R135611 |
| JOHN DEERE | R133707 | A-R133707 | JOHN DEERE | R135612 | A-R135612 |
| JOHN DEERE | R133852 | A-R133852 | JOHN DEERE | R135613 | A-R135613 |
| JOHN DEERE | R133853 | A-R133853 | JOHN DEERE | R135614 | A-R135614 |
| JOHN DEERE | R134299 | A-R134299 | JOHN DEERE | R135615 | A-R135615 |
| JOHN DEERE | R134594 | A-R134594 | JOHN DEERE | R135663 | A-R135663 |
| JOHN DEERE | R134599 | A-R134599 | JOHN DEERE | R135664 | A-R135664 |
| JOHN DEERE | R134625 | A-R134625 | JOHN DEERE | R135665 | A-R135665 |
| JOHN DEERE | R134630 | A-R134630 | JOHN DEERE | R135680 | A-R135680 |





JOHN DEERE

| OEM | OEM  Part No. | PIX  Part No. | OEM | OEM  Part No. | PIX  Part No. |
|------------|--|--|------------|--|--|
| JOHN DEERE | R135681 | A-R135681 | JOHN DEERE | R500379 | A-R500379 |
| JOHN DEERE | R135822 | A-R135822 | JOHN DEERE | R500380 | A-R500380 |
| JOHN DEERE | R135823 | A-R135823 | JOHN DEERE | R500381 | A-R500381 |
| JOHN DEERE | R135824 | A-R135824 | JOHN DEERE | R500382 | A-R500382 |
| JOHN DEERE | R135826 | A-R135826 | JOHN DEERE | R500383 | A-R500383 |
| JOHN DEERE | R135977 | A-R135977 | JOHN DEERE | R500384 | A-R500384 |
| JOHN DEERE | R136235 | A-R136235 | JOHN DEERE | R500385 | A-R500385 |
| JOHN DEERE | R136284 | A-R136284 | JOHN DEERE | R500616 | A-R500616 |
| JOHN DEERE | R136384 | A-R136384 | JOHN DEERE | R501007 | A-R501007 |
| JOHN DEERE | R136535 | A-R136535 | JOHN DEERE | R501017 | A-R501017 |
| JOHN DEERE | R156049 | A-R156049 | JOHN DEERE | R501053 | A-R501053 |
| JOHN DEERE | R156050 | A-R156050 | JOHN DEERE | R501191 | A-R501191 |
| JOHN DEERE | R157686 | A-R157686 | JOHN DEERE | R501266 | A-R501266 |
| JOHN DEERE | R157687 | A-R157687 | JOHN DEERE | R501308 | A-R501308 |
| JOHN DEERE | R157688 | A-R157688 | JOHN DEERE | R501526 | A-R501526 |
| JOHN DEERE | R157688 | A-R157688 | JOHN DEERE | R502016 | A-R502016 |
| JOHN DEERE | R174754 | A-R174754 | JOHN DEERE | R502078 | A-R502078 |
| JOHN DEERE | R175712 | A-R175712 | JOHN DEERE | R502086 | A-R502086 |
| JOHN DEERE | R175825 | A-R175825 | JOHN DEERE | R502089 | A-R502089 |
| JOHN DEERE | R175826 | A-R175826 | JOHN DEERE | R502186 | A-R502186 |
| JOHN DEERE | R181917 | A-R181917 | JOHN DEERE | R502306 | A-R502306 |
| JOHN DEERE | R181918 | A-R181918 | JOHN DEERE | R502416 | A-R502416 |
| JOHN DEERE | R190199 | A-R190199 | JOHN DEERE | R502417 | A-R502417 |
| JOHN DEERE | R199163 | A-R199163 | JOHN DEERE | R502418 | A-R502418 |
| JOHN DEERE | R200920 | A-R200920 | JOHN DEERE | R502461 | A-R502461 |
| JOHN DEERE | R202628 | A-R202628 | JOHN DEERE | R502476 | A-R502476 |
| JOHN DEERE | R205438 | A-R205438 | JOHN DEERE | R502599 | A-R502599 |
| JOHN DEERE | R206983 | A-R206983 | JOHN DEERE | R503311 | A-R503311 |
| JOHN DEERE | R208755 | A-R208755 | JOHN DEERE | R503323 | A-R503323 |
| JOHN DEERE | R210808 | A-R210808 | JOHN DEERE | R503324 | A-R503324 |
| JOHN DEERE | R211183 | A-R211183 | JOHN DEERE | R503571 | A-R503571 |
| JOHN DEERE | R216071 | A-R216071 | JOHN DEERE | R503726 | A-R503726 |
| JOHN DEERE | R222393 | A-R222393 | JOHN DEERE | R503932 | A-R503932 |
| JOHN DEERE | R228118 | A-R228118 | JOHN DEERE | R504022 | A-R504022 |
| JOHN DEERE | R228566 | A-R228566 | JOHN DEERE | R504023 | A-R504023 |
| JOHN DEERE | R239551 | A-R239551 | JOHN DEERE | R504963 | A-R504963 |
| JOHN DEERE | R241746 | A-R241746 | JOHN DEERE | R505186 | A-R505186 |
| JOHN DEERE | R267275 | A-R267275 | JOHN DEERE | R505810 | A-R505810 |
| JOHN DEERE | R269530 | A-R269530 | JOHN DEERE | R505812 | A-R505812 |
| JOHN DEERE | R269531 | A-R269531 | JOHN DEERE | R515127 | A-R515127 |
| JOHN DEERE | R288922 | A-R288922 | JOHN DEERE | R515209 | A-R515209 |
| JOHN DEERE | R500089 | A-R500089 | JOHN DEERE | R515217 | A-R515217 |
| JOHN DEERE | R500090 | A-R500090 | JOHN DEERE | R515219 | A-R515219 |
| JOHN DEERE | R500173 | A-R500173 | JOHN DEERE | R515220 | A-R515220 |
| JOHN DEERE | R500244 | A-R500244 | JOHN DEERE | R515222 | A-R515222 |
| JOHN DEERE | R500377 | A-R500377 | JOHN DEERE | R517012 | A-R517012 |
| JOHN DEERE | R500378 | A-R500378 | JOHN DEERE | R517039 | A-R517039 |





JOHN DEERE

| OEM | OEM  Part No. | PIX  Part No. | OEM | OEM  Part No. | PIX  Part No. |
|------------|--|--|------------|--|--|
| JOHN DEERE | R517041 | A-R517041 | JOHN DEERE | SA00901 | A-SA00901 |
| JOHN DEERE | R518368 | A-R518368 | JOHN DEERE | SA01001 | A-SA01001 |
| JOHN DEERE | R71602 | A-R71602 | JOHN DEERE | SA01201 | A-SA01201 |
| JOHN DEERE | R94373 | A-R94373 | JOHN DEERE | SA01401 | A-SA01401 |
| JOHN DEERE | R95917 | A-R95917 | JOHN DEERE | SA01601 | A-SA01601 |
| JOHN DEERE | R95924 | A-R95924 | JOHN DEERE | SA01701 | A-SA01701 |
| JOHN DEERE | R96255 | A-R96255 | JOHN DEERE | SA02001 | A-SA02001 |
| JOHN DEERE | R97758 | A-R97758 | JOHN DEERE | SA35274 | A-SA35274 |
| JOHN DEERE | R98510 | A-R98510 | JOHN DEERE | SA35425 | A-SA35425 |
| JOHN DEERE | RE28721 | A-RE28721 | JOHN DEERE | SA36024 | A-SA36024 |
| JOHN DEERE | RE29018 | A-RE29018 | JOHN DEERE | SA36101 | A-SA36101 |
| JOHN DEERE | RE41942 | A-RE41942 | JOHN DEERE | SA36130 | A-SA36130 |
| JOHN DEERE | S07074 | A-S07074 | JOHN DEERE | SA36192 | A-SA36192 |
| JOHN DEERE | S07075 | A-S07075 | JOHN DEERE | SA36523 | A-SA36523 |
| JOHN DEERE | S08035 | A-S08035 | JOHN DEERE | SA36536 | A-SA36536 |
| JOHN DEERE | S13042 | A-S13042 | JOHN DEERE | SA36701 | A-SA36701 |
| JOHN DEERE | S17045 | A-S17045 | JOHN DEERE | SA36717 | A-SA36717 |
| JOHN DEERE | S20718 | A-S20718 | JOHN DEERE | SAU10552 | A-SAU10552 |
| JOHN DEERE | S33368 | A-S33368 | JOHN DEERE | SAU10691 | A-SAU10691 |
| JOHN DEERE | S33510 | A-S33510 | JOHN DEERE | SAU11073 | A-SAU11073 |
| JOHN DEERE | S33512 | A-S33512 | JOHN DEERE | SAU11158 | A-SAU11158 |
| JOHN DEERE | S33602 | A-S33602 | JOHN DEERE | SAU11284 | A-SAU11284 |
| JOHN DEERE | S33605 | A-S33605 | JOHN DEERE | SAU11321 | A-SAU11321 |
| JOHN DEERE | S33607 | A-S33607 | JOHN DEERE | SAU11644 | A-SAU11644 |
| JOHN DEERE | S33721 | A-S33721 | JOHN DEERE | SAU11645 | A-SAU11645 |
| JOHN DEERE | S37599 | A-S37599 | JOHN DEERE | SAU12081 | A-SAU12081 |
| JOHN DEERE | S37687 | A-S37687 | JOHN DEERE | T10552 | A-T10552 |
| JOHN DEERE | S38916 | A-S38916 | JOHN DEERE | T111546 | A-T111546 |
| JOHN DEERE | S41607 | A-S41607 | JOHN DEERE | T148208 | A-T148208 |
| JOHN DEERE | S41608 | A-S41608 | JOHN DEERE | T155457 | A-T155457 |
| JOHN DEERE | S41884 | A-S41884 | JOHN DEERE | T160034 | A-T160034 |
| JOHN DEERE | S42174 | A-S42174 | JOHN DEERE | T160036 | A-T160036 |
| JOHN DEERE | S43359 | A-S43359 | JOHN DEERE | T164949 | A-T164949 |
| JOHN DEERE | S43537 | A-S43537 | JOHN DEERE | T166823 | A-T166823 |
| JOHN DEERE | S60001 | A-S60001 | JOHN DEERE | T178409 | A-T178409 |
| JOHN DEERE | S60004 | A-S60004 | JOHN DEERE | T178410 | A-T178410 |
| JOHN DEERE | S60011 | A-S60011 | JOHN DEERE | T178411 | A-T178411 |
| JOHN DEERE | S60012 | A-S60012 | JOHN DEERE | T178412 | A-T178412 |
| JOHN DEERE | S60016 | A-S60016 | JOHN DEERE | T178413 | A-T178413 |
| JOHN DEERE | S60018 | A-S60018 | JOHN DEERE | T178414 | A-T178414 |
| JOHN DEERE | S60021 | A-S60021 | JOHN DEERE | T178415 | A-T178415 |
| JOHN DEERE | S60022 | A-S60022 | JOHN DEERE | T178416 | A-T178416 |
| JOHN DEERE | SA00101 | A-SA00101 | JOHN DEERE | T178417 | A-T178417 |
| JOHN DEERE | SA00201 | A-SA00201 | JOHN DEERE | T178418 | A-T178418 |
| JOHN DEERE | SA00301 | A-SA00301 | JOHN DEERE | T178419 | A-T178419 |
| JOHN DEERE | SA00401 | A-SA00401 | JOHN DEERE | T178420 | A-T178420 |
| JOHN DEERE | SA00501 | A-SA00501 | JOHN DEERE | T178421 | A-T178421 |



JOHN DEERE

| OEM | OEM  Part No. | PIX  Part No. | OEM | OEM  Part No. | PIX  Part No. |
|------------|--|--|------------|--|--|
| JOHN DEERE | T178422 | A-T178422 | JOHN DEERE | YC10136 | A-YC10136 |
| JOHN DEERE | T178423 | A-T178423 | JOHN DEERE | YC10139 | A-YC10139 |
| JOHN DEERE | T178465 | A-T178465 | JOHN DEERE | YC10140 | A-YC10140 |
| JOHN DEERE | T178536 | A-T178536 | JOHN DEERE | YC10142 | A-YC10142 |
| JOHN DEERE | T178537 | A-T178537 | JOHN DEERE | YC10144 | A-YC10144 |
| JOHN DEERE | T178538 | A-T178538 | JOHN DEERE | YC10145 | A-YC10145 |
| JOHN DEERE | T178539 | A-T178539 | JOHN DEERE | YC10148 | A-YC10148 |
| JOHN DEERE | T178548 | A-T178548 | JOHN DEERE | YC17499 | A-YC17499 |
| JOHN DEERE | T180368 | A-T180368 | JOHN DEERE | YC19018 | A-YC19018 |
| JOHN DEERE | T182169 | A-T182169 | JOHN DEERE | YC19023 | A-YC19023 |
| JOHN DEERE | T184590 | A-T184590 | JOHN DEERE | YC19024 | A-YC19024 |
| JOHN DEERE | T184592 | A-T184592 | JOHN DEERE | YC19027 | A-YC19027 |
| JOHN DEERE | T184594 | A-T184594 | JOHN DEERE | YC25169 | A-YC25169 |
| JOHN DEERE | T184595 | A-T184595 | JOHN DEERE | YC25170 | A-YC25170 |
| JOHN DEERE | T185061 | A-T185061 | JOHN DEERE | Z101214 | A-Z101214 |
| JOHN DEERE | T185081 | A-T185081 | JOHN DEERE | Z103479 | A-Z103479 |
| JOHN DEERE | T186776 | A-T186776 | JOHN DEERE | Z103583 | A-Z103583 |
| JOHN DEERE | T187391 | A-T187391 | JOHN DEERE | Z103861 | A-Z103861 |
| JOHN DEERE | T187704 | A-T187704 | JOHN DEERE | Z103867 | A-Z103867 |
| JOHN DEERE | T189016 | A-T189016 | JOHN DEERE | Z104104 | A-Z104104 |
| JOHN DEERE | T190384 | A-T190384 | JOHN DEERE | Z104978 | A-Z104978 |
| JOHN DEERE | T190809 | A-T190809 | JOHN DEERE | Z105041 | A-Z105041 |
| JOHN DEERE | T190810 | A-T190810 | JOHN DEERE | Z105506 | A-Z105506 |
| JOHN DEERE | T190817 | A-T190817 | JOHN DEERE | Z115368 | A-Z115368 |
| JOHN DEERE | T26755 | A-T26755 | JOHN DEERE | Z117398 | A-Z117398 |
| JOHN DEERE | TCU12829 | A-TCU12829 | JOHN DEERE | Z20823A | A-Z20823A |
| JOHN DEERE | TCU13749 | A-TCU13749 | JOHN DEERE | Z21113 | A-Z21113 |
| JOHN DEERE | TCU16026 | A-TCU16026 | JOHN DEERE | Z22556 | A-Z22556 |
| JOHN DEERE | TCU16841 | A-TCU16841 | JOHN DEERE | Z22832 | A-Z22832 |
| JOHN DEERE | TCU29452 | A-TCU29452 | JOHN DEERE | Z23086 | A-Z23086 |
| JOHN DEERE | TCU29453 | A-TCU29453 | JOHN DEERE | Z23087 | A-Z23087 |
| JOHN DEERE | TCU29454 | A-TCU29454 | JOHN DEERE | Z23475 | A-Z23475 |
| JOHN DEERE | TCU29455 | A-TCU29455 | JOHN DEERE | Z23476 | A-Z23476 |
| JOHN DEERE | TCU30356 | A-TCU30356 | JOHN DEERE | Z24729 | A-Z24729 |
| JOHN DEERE | TCU30510 | A-TCU30510 | JOHN DEERE | Z24833 | A-Z24833 |
| JOHN DEERE | TCU31132 | A-TCU31132 | JOHN DEERE | Z26628 | A-Z26628 |
| JOHN DEERE | TCU31194 | A-TCU31194 | JOHN DEERE | Z27710 | A-Z27710 |
| JOHN DEERE | VK648204 | A-VK648204 | JOHN DEERE | Z28339 | A-Z28339 |
| JOHN DEERE | VK648215 | A-VK648215 | JOHN DEERE | Z28842 | A-Z28842 |
| JOHN DEERE | VK648216 | A-VK648216 | JOHN DEERE | Z29962 | A-Z29962 |
| JOHN DEERE | VK648223 | A-VK648223 | JOHN DEERE | Z30881 | A-Z30881 |
| JOHN DEERE | W10389 | A-W10389 | JOHN DEERE | Z31376 | A-Z31376 |
| JOHN DEERE | W14431 | A-W14431 | JOHN DEERE | Z32173 | A-Z32173 |
| JOHN DEERE | W26375 | A-W26375 | JOHN DEERE | Z32514 | A-Z32514 |
| JOHN DEERE | W30582 | A-W30582 | JOHN DEERE | Z33368 | A-Z33368 |
| JOHN DEERE | Y55970 | A-Y55970 | JOHN DEERE | Z35356 | A-Z35356 |
| JOHN DEERE | YC10134 | A-YC10134 | JOHN DEERE | Z35357 | A-Z35357 |



JOHN DEERE

| OEM | OEM  Part No. | PIX  Part No. | OEM | OEM  Part No. | PIX  Part No. |
|------------|--|--|------------|--|--|
| JOHN DEERE | Z35358 | A-Z35358 | JOHN DEERE | ZY96548 | A-ZY96548 |
| JOHN DEERE | Z36499 | A-Z36499 | JOHN DEERE | ZY96551 | A-ZY96551 |
| JOHN DEERE | Z36770 | A-Z36770 | JOHN DEERE | ZY96558 | A-ZY96558 |
| JOHN DEERE | Z36771 | A-Z36771 | JOHN DEERE | HXE22617 | A-HXE22617 |
| JOHN DEERE | Z37121 | A-Z37121 | JOHN DEERE | HXE54503 | A-HXE54503 |
| JOHN DEERE | Z37476 | A-Z37476 | JOHN DEERE | AXE42095 | A-AXE42095 |
| JOHN DEERE | Z38698 | A-Z38698 | JOHN DEERE | HXE100455 | A-HXE100455 |
| JOHN DEERE | Z38699 | A-Z38699 | JOHN DEERE | HXE107624 | A-HXE107624 |
| JOHN DEERE | Z38708 | A-Z38708 | JOHN DEERE | HXE11117 | A-HXE11117 |
| JOHN DEERE | Z41889 | A-Z41889 | JOHN DEERE | HXE114322 | A-HXE114322 |
| JOHN DEERE | Z44762 | A-Z44762 | JOHN DEERE | HXE124870 | A-HXE124870 |
| JOHN DEERE | Z44937 | A-Z44937 | JOHN DEERE | HXE150557 | A-HXE150557 |
| JOHN DEERE | Z45359 | A-Z45359 | JOHN DEERE | HXE152482 | A-HXE152482 |
| JOHN DEERE | Z45369 | A-Z45369 | JOHN DEERE | HXE22090 | A-HXE22090 |
| JOHN DEERE | Z46463A | A-Z46463A | JOHN DEERE | HXE23801 | A-HXE23801 |
| JOHN DEERE | Z48472 | A-Z48472 | JOHN DEERE | HXE34465 | A-HXE34465 |
| JOHN DEERE | Z48567 | A-Z48567 | JOHN DEERE | HXE40179 | A-HXE40179 |
| JOHN DEERE | Z51089 | A-Z51089 | JOHN DEERE | HXE40946 | A-HXE40946 |
| JOHN DEERE | Z51202 | A-Z51202 | JOHN DEERE | HXE63990 | A-HXE63990 |
| JOHN DEERE | Z51202 | A-Z51202 | JOHN DEERE | HXE65360 | A-HXE65360 |
| JOHN DEERE | Z51708 | A-Z51708 | JOHN DEERE | HXE65361 | A-HXE65361 |
| JOHN DEERE | Z52009 | A-Z52009 | JOHN DEERE | HXE69280 | A-HXE69280 |
| JOHN DEERE | Z53478 | A-Z53478 | JOHN DEERE | HXE72209 | A-HXE72209 |
| JOHN DEERE | Z53515 | A-Z53515 | JOHN DEERE | HXE72281 | A-HXE72281 |
| JOHN DEERE | Z54332 | A-Z54332 | JOHN DEERE | HXE73027 | A-HXE73027 |
| JOHN DEERE | Z55771 | A-Z55771 | JOHN DEERE | HXE73048 | A-HXE73048 |
| JOHN DEERE | Z56313 | A-Z56313 | JOHN DEERE | HXE73530 | A-HXE73530 |
| JOHN DEERE | Z56351 | A-Z56351 | JOHN DEERE | HXE73868 | A-HXE73868 |
| JOHN DEERE | Z56352 | A-Z56352 | JOHN DEERE | HXE74209 | A-HXE74209 |
| JOHN DEERE | Z56829 | A-Z56829 | JOHN DEERE | HXE74439 | A-HXE74439 |
| JOHN DEERE | Z57235 | A-Z57235 | JOHN DEERE | HXE74517 | A-HXE74517 |
| JOHN DEERE | Z58886 | A-Z58886 | JOHN DEERE | HXE74560 | A-HXE74560 |
| JOHN DEERE | Z59255 | A-Z59255 | JOHN DEERE | HXE75054 | A-HXE75054 |
| JOHN DEERE | Z59930 | A-Z59930 | JOHN DEERE | HXE75142 | A-HXE75142 |
| JOHN DEERE | Z62025 | A-Z62025 | JOHN DEERE | HXE76183 | A-HXE76183 |
| JOHN DEERE | Z63322 | A-Z63322 | JOHN DEERE | HXE79558 | A-HXE79558 |
| JOHN DEERE | Z63327 | A-Z63327 | JOHN DEERE | HXE82335 | A-HXE82335 |
| JOHN DEERE | Z65924 | A-Z65924 | JOHN DEERE | HXE86445 | A-HXE86445 |
| JOHN DEERE | Z66787 | A-Z66787 | JOHN DEERE | HXE87482 | A-HXE87482 |
| JOHN DEERE | Z66873 | A-Z66873 | JOHN DEERE | HXE88939 | A-HXE88939 |
| JOHN DEERE | Z67326 | A-Z67326 | JOHN DEERE | HXE94485 | A-HXE94485 |
| JOHN DEERE | Z73506 | A-Z73506 | JOHN DEERE | HXE94488 | A-HXE94488 |
| JOHN DEERE | Z75245 | A-Z75245 | JOHN DEERE | HXE95150 | A-HXE95150 |
| JOHN DEERE | Z75246 | A-Z75246 | JOHN DEERE | HXE95151 | A-HXE95151 |
| JOHN DEERE | Z77222 | A-Z77222 | JOHN DEERE | HXE95511 | A-HXE95511 |
| JOHN DEERE | Z78860 | A-Z78860 | JOHN DEERE | HXE98150 | A-HXE98150 |
| JOHN DEERE | Z81070 | A-Z81070 | JOHN DEERE | HXE99294 | A-HXE99294 |
| JOHN DEERE | Z9281H | A-Z9281H | JOHN DEERE | R551022 | A-R551022 |
| JOHN DEERE | ZX64616 | A-ZX64616 | JOHN DEERE | Z81937 | A-Z81937 |
| JOHN DEERE | ZY86859 | A-ZY86859 | JOHN DEERE | E94524 | A-E94524 |
| JOHN DEERE | ZY94047 | A-ZY94047 | JOHN DEERE | FH320240 | A-FH320240 |
| JOHN DEERE | ZY94115 | A-ZY94115 | JOHN DEERE | HXE130612 | A-HXE130612 |
| JOHN DEERE | ZY95337 | A-ZY95337 | JOHN DEERE | L69272 | A-L69272 |

KPAB

| OEM | OEM  Part No. | PIX  Part No. |
|------|--|--|
| KPAB | 904020 | A-904020 |
| KPAB | 904022 | A-904022 |
| KPAB | 904030 | A-904030 |
| KPAB | 904033 | A-904033 |
| KPAB | 904036 | A-904036 |
| KPAB | 904041 | A-904041 |
| KPAB | 904042 | A-904042 |
| KPAB | 904043 | A-904043 |
| KPAB | 904045 | A-904045 |
| KPAB | 904047 | A-904047 |



KRONE

| OEM | OEM  Part No. | PIX  Part No. |
|-------|--|--|
| KRONE | 9215232 | A-9215232 |
| KRONE | 9215241 | A-9215241 |
| KRONE | 9215251 | A-9215251 |
| KRONE | 9215260 | A-9215260 |
| KRONE | 9215270 | A-9215270 |
| KRONE | 9215280 | A-9215280 |
| KRONE | 9215290 | A-9215290 |
| KRONE | 9215300 | A-9215300 |
| KRONE | 9215310 | A-9215310 |
| KRONE | 9215320 | A-9215320 |
| KRONE | 9215330 | A-9215330 |
| KRONE | 9215360 | A-9215360 |
| KRONE | 9215370 | A-9215370 |
| KRONE | 9215380 | A-9215380 |
| KRONE | 9215390 | A-9215390 |
| KRONE | 9215400 | A-9215400 |
| KRONE | 9215412 | A-9215412 |
| KRONE | 9215420 | A-9215420 |
| KRONE | 9215450 | A-9215450 |
| KRONE | 9215470 | A-9215470 |
| KRONE | 9215520 | A-9215520 |
| KRONE | 9215530 | A-9215530 |
| KRONE | 9215540 | A-9215540 |
| KRONE | 9215550 | A-9215550 |
| KRONE | 9215560 | A-9215560 |
| KRONE | 9215570 | A-9215570 |
| KRONE | 9215861 | A-9215861 |
| KRONE | 9215931 | A-9215931 |
| KRONE | 9215962 | A-9215962 |
| KRONE | 9215981 | A-9215981 |
| KRONE | 9216000 | A-9216000 |
| KRONE | 9216010 | A-9216010 |
| KRONE | 9216030 | A-9216030 |
| KRONE | 9216070 | A-9216070 |



KRONE

| | | |
|-------|---------|-----------|
| KRONE | 2150791 | A-2150791 |
| KRONE | 2168800 | A-2168800 |
| KRONE | 2211880 | A-2211880 |
| KRONE | 2240410 | A-2240410 |
| KRONE | 2253560 | A-2253560 |
| KRONE | 2253610 | A-2253610 |
| KRONE | 2266930 | A-2266930 |
| KRONE | 2279090 | A-2279090 |
| KRONE | 2279101 | A-2279101 |
| KRONE | 2279251 | A-2279251 |
| KRONE | 2282321 | A-2282321 |
| KRONE | 2282330 | A-2282330 |
| KRONE | 2282340 | A-2282340 |
| KRONE | 2282350 | A-2282350 |
| KRONE | 2282360 | A-2282360 |
| KRONE | 2282430 | A-2282430 |
| KRONE | 9215002 | A-9215002 |
| KRONE | 9215010 | A-9215010 |
| KRONE | 9215030 | A-9215030 |
| KRONE | 9215040 | A-9215040 |
| KRONE | 9215050 | A-9215050 |
| KRONE | 9215060 | A-9215060 |
| KRONE | 9215070 | A-9215070 |
| KRONE | 9215090 | A-9215090 |
| KRONE | 9215101 | A-9215101 |
| KRONE | 9215102 | A-9215102 |
| KRONE | 9215110 | A-9215110 |
| KRONE | 9215121 | A-9215121 |
| KRONE | 9215130 | A-9215130 |
| KRONE | 9215140 | A-9215140 |
| KRONE | 9215151 | A-9215151 |
| KRONE | 9215161 | A-9215161 |
| KRONE | 9215181 | A-9215181 |
| KRONE | 9215190 | A-9215190 |
| KRONE | 9215221 | A-9215221 |





KUHN

| OEM | OEM  Part No. | PIX  Part No. |
|------|--|--|
| KUHN | 83101059 | A-83101059 |
| KUHN | 83101067 | A-83101067 |
| KUHN | 83101252 | A-83101252 |
| KUHN | 83101253 | A-83101253 |
| KUHN | 83101270 | A-83101270 |
| KUHN | 83101286 | A-83101286 |
| KUHN | 83101656 | A-83101656 |
| KUHN | 83101658 | A-83101658 |
| KUHN | 83101670 | A-83101670 |
| KUHN | 83101672 | A-83101672 |
| KUHN | 83101673 | A-83101673 |
| KUHN | 83101680 | A-83101680 |
| KUHN | 83101681 | A-83101681 |
| KUHN | 83101682 | A-83101682 |
| KUHN | 83101687 | A-83101687 |
| KUHN | 83101688 | A-83101688 |
| KUHN | 83101764 | A-83101764 |
| KUHN | 83101778 | A-83101778 |
| KUHN | 83101782 | A-83101782 |
| KUHN | 83101785 | A-83101785 |
| KUHN | 83101791 | A-83101791 |
| KUHN | 83101792 | A-83101792 |
| KUHN | 83101795 | A-83101795 |
| KUHN | 83101796 | A-83101796 |
| KUHN | 83101797 | A-83101797 |
| KUHN | 83101798 | A-83101798 |
| KUHN | 83111677 | A-83111677 |
| KUHN | 83111679 | A-83111679 |
| KUHN | 83111682 | A-83111682 |
| KUHN | 83111683 | A-83111683 |





KVERNELAND

| OEM | OEM  Part No. | PIX  Part No. |
|------------|--|--|
| KVERNELAND | 0000930 | A-0000930 |
| KVERNELAND | 0000930D | A-0000930D |
| KVERNELAND | 0000930M | A-0000930M |
| KVERNELAND | 0000939 | A-0000939 |
| KVERNELAND | 0000942 | A-0000942 |
| KVERNELAND | 0000942D | A-0000942D |
| KVERNELAND | 0000943 | A-0000943 |
| KVERNELAND | 0000944 | A-0000944 |
| KVERNELAND | 0001099 | A-0001099 |
| KVERNELAND | 0001108 | A-0001108 |
| KVERNELAND | 0001160 | A-0001160 |
| KVERNELAND | 0001218 | A-0001218 |
| KVERNELAND | 0001224 | A-0001224 |
| KVERNELAND | 1142085 | A-01142085 |
| KVERNELAND | 37771407 | A-37771407 |
| KVERNELAND | 43301603 | A-43301603 |
| KVERNELAND | 43303407 | A-43303407 |
| KVERNELAND | 43303410 | A-43303410 |
| KVERNELAND | 43303412 | A-43303412 |
| KVERNELAND | 43303413 | A-43303413 |
| KVERNELAND | 43303417 | A-43303417 |
| KVERNELAND | 43303418 | A-43303418 |
| KVERNELAND | 43303420 | A-43303420 |
| KVERNELAND | 43303424 | A-43303424 |
| KVERNELAND | 43303426 | A-43303426 |
| KVERNELAND | 43303427 | A-43303427 |
| KVERNELAND | 43303429 | A-43303429 |
| KVERNELAND | 43303432 | A-43303432 |
| KVERNELAND | 43303434 | A-43303434 |
| KVERNELAND | 99201011 | A-99201011 |
| KVERNELAND | 99201014 | A-99201014 |
| KVERNELAND | 99201017 | A-99201017 |
| KVERNELAND | 99201020 | A-99201020 |
| KVERNELAND | 99201032 | A-99201032 |
| KVERNELAND | 99201038 | A-99201038 |
| KVERNELAND | 99201040 | A-99201040 |
| KVERNELAND | 99201411 | A-99201411 |
| KVERNELAND | 99201412 | A-99201412 |
| KVERNELAND | 99201413 | A-99201413 |
| KVERNELAND | 99201414 | A-99201414 |
| KVERNELAND | 99201418 | A-99201418 |
| KVERNELAND | 99201420 | A-99201420 |
| KVERNELAND | 99201422 | A-99201422 |
| KVERNELAND | 99201424 | A-99201424 |
| KVERNELAND | 99201510 | A-99201510 |
| KVERNELAND | 99202008 | A-99202008 |
| KVERNELAND | 99202009 | A-99202009 |





KVERNELAND

| OEM | OEM  Part No. | PIX  Part No. | OEM | OEM  Part No. | PIX  Part No. |
|------------|--|--|------------|--|--|
| KVERNELAND | 99202011 | A-99202011 | KVERNELAND | 99203010 | A-99203010 |
| KVERNELAND | 99202012 | A-99202012 | KVERNELAND | 99203012 | A-99203012 |
| KVERNELAND | 99202013 | A-99202013 | KVERNELAND | 99203014 | A-99203014 |
| KVERNELAND | 99202014 | A-99202014 | KVERNELAND | 99203015 | A-99203015 |
| KVERNELAND | 99202015 | A-99202015 | KVERNELAND | 99203016 | A-99203016 |
| KVERNELAND | 99202016 | A-99202016 | KVERNELAND | 99203017 | A-99203017 |
| KVERNELAND | 99202017 | A-99202017 | KVERNELAND | 99203018 | A-99203018 |
| KVERNELAND | 99202018 | A-99202018 | KVERNELAND | 99203019 | A-99203019 |
| KVERNELAND | 99202019 | A-99202019 | KVERNELAND | 99203020 | A-99203020 |
| KVERNELAND | 99202021 | A-99202021 | KVERNELAND | 99203021 | A-99203021 |
| KVERNELAND | 99202022 | A-99202022 | KVERNELAND | 99203022 | A-99203022 |
| KVERNELAND | 99202024 | A-99202024 | KVERNELAND | 99203023 | A-99203023 |
| KVERNELAND | 99202025 | A-99202025 | KVERNELAND | 99203024 | A-99203024 |
| KVERNELAND | 99202026 | A-99202026 | KVERNELAND | 99203025 | A-99203025 |
| KVERNELAND | 99202027 | A-99202027 | KVERNELAND | 99203026 | A-99203026 |
| KVERNELAND | 99202028 | A-99202028 | KVERNELAND | 99203027 | A-99203027 |
| KVERNELAND | 99202031 | A-99202031 | KVERNELAND | 99203029 | A-99203029 |
| KVERNELAND | 99202032 | A-99202032 | KVERNELAND | 99203038 | A-99203038 |
| KVERNELAND | 99202035 | A-99202035 | KVERNELAND | 99203039 | A-99203039 |
| KVERNELAND | 99202036 | A-99202036 | KVERNELAND | 99203042 | A-99203042 |
| KVERNELAND | 99202038 | A-99202038 | KVERNELAND | 99203045 | A-99203045 |
| KVERNELAND | 99202039 | A-99202039 | KVERNELAND | 99203046 | A-99203046 |
| KVERNELAND | 99202040 | A-99202040 | KVERNELAND | 99203048 | A-99203048 |
| KVERNELAND | 99202041 | A-99202041 | KVERNELAND | 99203050 | A-99203050 |
| KVERNELAND | 99202042 | A-99202042 | KVERNELAND | 99203052 | A-99203052 |
| KVERNELAND | 99202062 | A-99202062 | KVERNELAND | 99203056 | A-99203056 |
| KVERNELAND | 99202063 | A-99202063 | KVERNELAND | 99203063 | A-99203063 |
| KVERNELAND | 99202220 | A-99202220 | KVERNELAND | 99203082 | A-99203082 |
| KVERNELAND | 99202322 | A-99202322 | KVERNELAND | 99203083 | A-99203083 |
| KVERNELAND | 99202325 | A-99202325 | KVERNELAND | 99203085 | A-99203085 |
| KVERNELAND | A99202409 | A-99202409 | KVERNELAND | 99203086 | A-99203086 |
| KVERNELAND | A99202410 | A-99202410 | KVERNELAND | 99203087 | A-99203087 |
| KVERNELAND | 99202412 | A-99202412 | KVERNELAND | 99203088 | A-99203088 |
| KVERNELAND | 99202413 | A-99202413 | KVERNELAND | 99203090 | A-99203090 |
| KVERNELAND | 99202415 | A-99202415 | KVERNELAND | 99203091 | A-99203091 |
| KVERNELAND | 99202420 | A-99202420 | KVERNELAND | 99203093 | A-99203093 |
| KVERNELAND | 99202423 | A-99202423 | KVERNELAND | 99203203 | A-99203203 |
| KVERNELAND | 99202424 | A-99202424 | KVERNELAND | 99203204 | A-99203204 |
| KVERNELAND | 99202425 | A-99202425 | KVERNELAND | 99203208 | A-99203208 |
| KVERNELAND | 99202428 | A-99202428 | KVERNELAND | 99203210 | A-99203210 |
| KVERNELAND | 99202429 | A-99202429 | KVERNELAND | 99203211 | A-99203211 |
| KVERNELAND | 99202430 | A-99202430 | KVERNELAND | 99203212 | A-99203212 |
| KVERNELAND | 99202431 | A-99202431 | KVERNELAND | 99203213 | A-99203213 |
| KVERNELAND | 99202433 | A-99202433 | KVERNELAND | 99203215 | A-99203215 |
| KVERNELAND | 99203005 | A-99203005 | KVERNELAND | 99203216 | A-99203216 |
| KVERNELAND | 99203006 | A-99203006 | KVERNELAND | 99203218 | A-99203218 |
| KVERNELAND | 99203008 | A-99203008 | KVERNELAND | 99203245 | A-99203245 |





KUHN

| OEM | OEM  Part No. | PIX  Part No. | OEM | OEM  Part No. | PIX  Part No. |
|------------|--|--|------------|--|--|
| KVERNELAND | 99203250 | A-99203250 | KVERNELAND | ND96053 | A-ND96053 |
| KVERNELAND | 99203310 | A-99203310 | KVERNELAND | ND96063 | A-ND96063 |
| KVERNELAND | 99203315 | A-99203315 | KVERNELAND | ND96067 | A-ND96067 |
| KVERNELAND | 99203320 | A-99203320 | KVERNELAND | ND96068 | A-ND96068 |
| KVERNELAND | 99203330 | A-99203330 | KVERNELAND | ND96070 | A-ND96070 |
| KVERNELAND | 99203331 | A-99203331 | KVERNELAND | ND96074 | A-ND96074 |
| KVERNELAND | 99203332 | A-99203332 | KVERNELAND | ND96075 | A-ND96075 |
| KVERNELAND | 99203333 | A-99203333 | KVERNELAND | ND96078 | A-ND96078 |
| KVERNELAND | 99203335 | A-99203335 | KVERNELAND | ND96082 | A-ND96082 |
| KVERNELAND | 99203415 | A-99203415 | KVERNELAND | ND96083 | A-ND96083 |
| KVERNELAND | 99203418 | A-99203418 | KVERNELAND | ND96084 | A-ND96084 |
| KVERNELAND | 99203419 | A-99203419 | KVERNELAND | ND96085 | A-ND96085 |
| KVERNELAND | 99203422 | A-99203422 | KVERNELAND | ND96087 | A-ND96087 |
| KVERNELAND | 99204062 | A-99204062 | KVERNELAND | ND96089 | A-ND96089 |
| KVERNELAND | 99204076 | A-99204076 | KVERNELAND | ND96090 | A-ND96090 |
| KVERNELAND | 99207010 | A-99207010 | KVERNELAND | ND96091 | A-ND96091 |
| KVERNELAND | 99207113 | A-99207113 | KVERNELAND | ND96096 | A-ND96096 |
| KVERNELAND | 99207225 | A-99207225 | KVERNELAND | ND96108 | A-ND96108 |
| KVERNELAND | AC494745 | A-A-C494745 | KVERNELAND | ND96109 | A-ND96109 |
| KVERNELAND | AC494836 | A-A-C494836 | KVERNELAND | ND9629 | A-ND9629 |
| KVERNELAND | AC690011 | A-AC690011 | KVERNELAND | ND9630 | A-ND9630 |
| KVERNELAND | AC690071 | A-AC690071 | KVERNELAND | ND9704 | A-ND9704 |
| KVERNELAND | AC690081 | A-AC690081 | KVERNELAND | ND9732 | A-ND9732 |
| KVERNELAND | AC690115 | A-AC690115 | KVERNELAND | ND9775 | A-ND9775 |
| KVERNELAND | AC690123 | A-AC690123 | KVERNELAND | ND9909 | A-ND9909 |
| KVERNELAND | AC690131 | A-AC690131 | KVERNELAND | ND9928 | A-ND9928 |
| KVERNELAND | AC690132 | A-AC690132 | KVERNELAND | ND9958 | A-ND9958 |
| KVERNELAND | AC690137 | A-AC690137 | KVERNELAND | RG00035618 | A-RG00035618 |
| KVERNELAND | AC690138 | A-AC690138 | KVERNELAND | RG00037276 | A-RG00037276 |
| KVERNELAND | AC690140 | A-A-C690140 | KVERNELAND | RG00040590 | A-RG00040590 |
| KVERNELAND | AC690149 | A-AC690149 | KVERNELAND | RG00040922 | A-RG00040922 |
| KVERNELAND | AC690150 | A-AC690150 | KVERNELAND | RG00040955 | A-RG00040955 |
| KVERNELAND | AC690154 | A-AC690154 | | | |
| KVERNELAND | AC690156 | A-AC690156 | | | |
| KVERNELAND | AC690164 | A-AC690164 | | | |
| KVERNELAND | AC690181 | A-AC690181 | | | |
| KVERNELAND | AC690201 | A-AC690201 | | | |
| KVERNELAND | AC690202 | A-AC690202 | | | |
| KVERNELAND | ND9198 | A-ND9198 | | | |
| KVERNELAND | ND9240 | A-ND9240 | | | |
| KVERNELAND | ND9257 | A-ND9257 | | | |
| KVERNELAND | ND96001 | A-ND96001 | | | |
| KVERNELAND | ND96006 | A-ND96006 | | | |
| KVERNELAND | ND96008 | A-ND96008 | | | |
| KVERNELAND | ND96016 | A-ND96016 | | | |
| KVERNELAND | ND96023 | A-ND96023 | | | |
| KVERNELAND | ND96029 | A-ND96029 | | | |





LAVERDA

| OEM | OEM  Part No. | PIX  Part No. | OEM | OEM  Part No. | PIX  Part No. |
|---------|--|--|---------|--|--|
| LAVERDA | 1909636 | A-1909636 | LAVERDA | 344311418K | A-344311418K |
| LAVERDA | 311127 | A-311127 | LAVERDA | 4310226 | A-4310226 |
| LAVERDA | 311134 | A-311134 | LAVERDA | 4311126 | A-4311126 |
| LAVERDA | 311222 | A-311222 | LAVERDA | 4311127 | A-4311127 |
| LAVERDA | 311230 | A-311230 | LAVERDA | 4311134 | A-4311134 |
| LAVERDA | 311316 | A-311316 | LAVERDA | 4311137 | A-4311137 |
| LAVERDA | 311318 | A-311318 | LAVERDA | 4311212 | A-4311212 |
| LAVERDA | 312128 | A-312128 | LAVERDA | 4311217 | A-4311217 |
| LAVERDA | 323019750 | A-323019750 | LAVERDA | 4311218 | A-4311218 |
| LAVERDA | 340311127 | A-340311127 | LAVERDA | 4311220 | A-4311220 |
| LAVERDA | 340432239 | A-340432239 | LAVERDA | 4311221 | A-4311221 |
| LAVERDA | 340432433 | A-340432433 | LAVERDA | 4311222 | A-4311222 |
| LAVERDA | 340432436 | A-340432436 | LAVERDA | 4311226 | A-4311226 |
| LAVERDA | 340432437 | A-340432437 | LAVERDA | 4311227 | A-4311227 |
| LAVERDA | 340432438 | A-340432438 | LAVERDA | 4311314 | A-4311314 |
| LAVERDA | 340433133 | A-340433133 | LAVERDA | 4311318 | A-4311318 |
| LAVERDA | 340433157 | A-340433157 | LAVERDA | 4311319 | A-4311319 |
| LAVERDA | 340433174 | A-340433174 | LAVERDA | 4311418 | A-4311418 |
| LAVERDA | 340433189 | A-340433189 | LAVERDA | 4311418K | A-4311418K |
| LAVERDA | 340433192 | A-340433192 | LAVERDA | 432232 | A-432232 |
| LAVERDA | 340433237 | A-340433237 | LAVERDA | 432239 | A-432239 |
| LAVERDA | 340433243 | A-340433243 | LAVERDA | 43224 | A-43224 |
| LAVERDA | 340433305 | A-340433305 | LAVERDA | 432243 | A-432243 |
| LAVERDA | 340433308 | A-340433308 | LAVERDA | 432246 | A-432246 |
| LAVERDA | 340433406 | A-340433406 | LAVERDA | 432250 | A-432250 |
| LAVERDA | 340433408 | A-340433408 | LAVERDA | 432436 | A-432436 |
| LAVERDA | 340433413 | A-340433413 | LAVERDA | 432437 | A-432437 |
| LAVERDA | 340433416 | A-340433416 | LAVERDA | 432438 | A-432438 |
| LAVERDA | 340433431 | A-340433431 | LAVERDA | 433045 | A-433045 |
| LAVERDA | 340433442 | A-340433442 | LAVERDA | 433129 | A-433129 |
| LAVERDA | 340433450 | A-340433450 | LAVERDA | 433131 | A-433131 |
| LAVERDA | 340433472 | A-340433472 | LAVERDA | 433132 | A-433132 |
| LAVERDA | 340433473 | A-340433473 | LAVERDA | 433133 | A-433133 |
| LAVERDA | 340433532 | A-340433532 | LAVERDA | 433134 | A-433134 |
| LAVERDA | 340433963 | A-340433963 | Laverda | 433138 | A-433138 |
| LAVERDA | 340434245 | A-340434245 | LAVERDA | 433143 | A-433143 |
| LAVERDA | 340434250 | A-340434250 | LAVERDA | 433144 | A-433144 |
| LAVERDA | 340435117 | A-340435117 | LAVERDA | 433151 | A-433151 |
| LAVERDA | 340435125 | A-340435125 | LAVERDA | 433154 | A-433154 |
| LAVERDA | 340435132 | A-340435132 | LAVERDA | 433157 | A-433157 |
| LAVERDA | 340-435-147 | A-340-435-147 | LAVERDA | 433162 | A-433162 |
| LAVERDA | 344310110 | A-344310110 | LAVERDA | 433176 | A-433176 |
| LAVERDA | 344310226 | A-344310226 | LAVERDA | 433179 | A-433179 |
| LAVERDA | 344311127K | A-344311127K | LAVERDA | 433181 | A-433181 |
| LAVERDA | 344311212K | A-344311212K | LAVERDA | 433182 | A-433182 |
| LAVERDA | 344311225 | A-344311225 | LAVERDA | 433184 | A-433184 |
| LAVERDA | 344311315 | A-344311315 | LAVERDA | 433189 | A-433189 |

LAVERDA





| OEM | OEM  Part No. | PIX  Part No. | OEM | OEM  Part No. | PIX  Part No. |
|---------|--|--|---------|--|--|
| LAVERDA | 433190 | A-433190 | LAVERDA | 433456 | A-433456 |
| LAVERDA | 433191 | A-433191 | LAVERDA | 433457 | A-433457 |
| LAVERDA | 433197 | A-433197 | LAVERDA | 433458 | A-433458 |
| LAVERDA | 433198 | A-433198 | LAVERDA | 433465 | A-433465 |
| LAVERDA | 433223 | A-433223 | LAVERDA | 433467 | A-433467 |
| LAVERDA | 433236 | A-433236 | LAVERDA | 433469 | A-433469 |
| LAVERDA | 433239 | A-433239 | LAVERDA | 433470 | A-433470 |
| LAVERDA | 433243 | A-433243 | LAVERDA | 433471 | A-433471 |
| LAVERDA | 433244 | A-433244 | LAVERDA | 433472 | A-433472 |
| LAVERDA | 433252 | A-433252 | LAVERDA | 433474 | A-433474 |
| LAVERDA | 433253 | A-433253 | LAVERDA | 433475 | A-433475 |
| LAVERDA | 433256 | A-433256 | LAVERDA | 4334751 | A-4334751 |
| LAVERDA | 433257 | A-433257 | LAVERDA | 433475K | A-433475K |
| LAVERDA | 433262 | A-433262 | LAVERDA | 433539 | A-433539 |
| LAVERDA | 433268 | A-433268 | LAVERDA | 433961 | A-433961 |
| LAVERDA | 433272 | A-433272 | LAVERDA | 433963 | A-433963 |
| LAVERDA | 433274 | A-433274 | LAVERDA | 433964 | A-433964 |
| LAVERDA | 433281 | A-433281 | LAVERDA | 433970 | A-433970 |
| LAVERDA | 433283 | A-433283 | LAVERDA | 433980 | A-433980 |
| LAVERDA | 433289 | A-433289 | LAVERDA | 433983 | A-433983 |
| LAVERDA | 433290 | A-433290 | LAVERDA | 433984 | A-433984 |
| LAVERDA | 433305 | A-433305 | LAVERDA | 434138 | A-434138 |
| LAVERDA | 433308 | A-433308 | LAVERDA | 4351146 | A-4351146 |
| LAVERDA | 433316 | A-433316 | LAVERDA | 435117 | A-435117 |
| LAVERDA | 433405 | A-433405 | LAVERDA | 435120 | A-435120 |
| LAVERDA | 433406 | A-433406 | LAVERDA | 435124 | A-435124 |
| LAVERDA | 433409 | A-433409 | LAVERDA | 435130 | A-435130 |
| LAVERDA | 433410 | A-433410 | LAVERDA | 435131 | A-435131 |
| LAVERDA | 433412 | A-433412 | LAVERDA | 435131K | A-435131K |
| LAVERDA | 433413 | A-433413 | LAVERDA | 435135 | A-435135 |
| LAVERDA | 433414 | A-433414 | LAVERDA | 435138 | A-435138 |
| LAVERDA | 433415 | A-433415 | LAVERDA | 435146 | A-435146 |
| LAVERDA | 433418 | A-433418 | LAVERDA | 435147 | A-435147 |
| LAVERDA | 433419 | A-433419 | LAVERDA | 435150 | A-435150 |
| LAVERDA | 433422 | A-433422 | Laverda | 435151 | A-435151 |
| LAVERDA | 433423 | A-433423 | LAVERDA | 435152 | A-435152 |
| LAVERDA | 433424 | A-433424 | LAVERDA | 435158 | A-435158 |
| LAVERDA | 433425 | A-433425 | LAVERDA | 4898546 | A-4898546 |
| LAVERDA | 433427 | A-433427 | LAVERDA | 70108 | A-70108 |
| LAVERDA | 433428 | A-433428 | LAVERDA | 8822704 | A-8822704 |
| LAVERDA | 433430 | A-433430 | LAVERDA | 340435156 | A-340435156 |
| LAVERDA | 433431 | A-433431 | | | |
| LAVERDA | 433432 | A-433432 | | | |
| LAVERDA | 433441 | A-433441 | | | |
| LAVERDA | 433446 | A-433446 | | | |
| LAVERDA | 433453 | A-433453 | | | |
| LAVERDA | 433455 | A-433455 | | | |

MASSEY FERGUSON (MF)

| OEM | OEM  Part No. | PIX  Part No. | OEM | OEM  Part No. | PIX  Part No. |
|-----|--|--|-----|--|--|
| MF | 059169R1 | A-059169R1 | MF | 144720M1 | A-144720M1 |
| MF | 065881T1 | A-065881T1 | MF | 1447778M91 | A-1447778M91 |
| MF | 1008980M1 | A-1008980M1 | MF | 147366M1 | A-147366M1 |
| MF | 1012134M1 | A-1012134M1 | MF | 1480826 | A-1480826 |
| MF | 1014342M1 | A-1014342M1 | MF | 1480826M1 | A-1480826M1 |
| MF | 1015003M1 | A-1015003M1 | MF | 1483277M1 | A-1483277M1 |
| MF | 1027577M91 | A-1027577M91 | MF | 1483372M1 | A-1483372M1 |
| MF | 1030912M91 | A-1030912M91 | MF | 1483881 | A-1483881 |
| MF | 1032843M1 | A-1032843M1 | MF | 1483882M1 | A-1483882M1 |
| MF | 1033077M1 | A-1033077M1 | MF | 1483883 | A-1483883 |
| MF | 1033078M1 | A-1033078M1 | MF | 1603701 | A-1603701 |
| MF | 1033137M1 | A-1033137M1 | MF | 1604055M1 | A-1604055M1 |
| MF | 1033198M1 | A-1033198M1 | MF | 1604524M1 | A-1604524M1 |
| MF | 1033376M1 | A-1033376M1 | MF | 1614333M1 | A-1614333M1 |
| MF | 1033451M1 | A-1033451M1 | MF | 1615254 | A-1615254 |
| MF | 1033685M1 | A-1033685M1 | MF | 1615333 | A-1615333 |
| MF | 1033731M1 | A-1033731M1 | MF | 1615333M | A-1615333M |
| MF | 1033813M1 | A-1033813M1 | MF | 1615715M1 | A-1615715M1 |
| MF | 1034188M1 | A-1034188M1 | MF | 1616477 | A-1616477 |
| MF | 1034707M1 | A-1034707M1 | MF | 1616477M1 | A-1616477M1 |
| MF | 1035667M1 | A-1035667M1 | MF | 1616714 | A-1616714 |
| MF | 1035690M1 | A-1035690M1 | MF | 1616714M1 | A-1616714M1 |
| MF | 1037667M1 | A-1037667M1 | MF | 1616715 | A-1616715 |
| MF | 1039570M1 | A-1039570M1 | MF | 1682684M1 | A-1682684M1 |
| MF | 1041487M1 | A-1041487M1 | MF | 1686614M91 | A-1686614M91 |
| MF | 1041598M1 | A-1041598M1 | MF | 1691764M1 | A-1691764M1 |
| MF | 1041614M1 | A-1041614M1 | MF | 1720255 | A-1720255 |
| MF | 1041621M1 | A-1041621M1 | MF | 1720647M1 | A-1720647M1 |
| MF | 1041658M1 | A-1041658M1 | MF | 1720674M1 | A-1720674M1 |
| MF | 1041659M1 | A-1041659M1 | MF | 1722836M1 | A-1722836M1 |
| MF | 1053399M1 | A-1053399M1 | MF | 1874973M1 | A-1874973M1 |
| MF | 1056409M1 | A-1056409M1 | MF | 195432M1 | A-195432M1 |
| MF | 1056423M1 | A-1056423M1 | MF | 197-6291 | A-197-6291 |
| MF | 1056877M1 | A-1056877M1 | MF | 200327M1 | A-200327M1 |
| MF | 1056914M1 | A-1056914M1 | MF | 200557M1 | A-200557M1 |
| MF | 1175125104 | A-1175-125-104.00 | MF | 201900M1 | A-201900M1 |
| MF | 1175-125-104.00 | A-1175-125-104.00 | MF | 202242M2 | A-202242M2 |
| MF | 140259M1 | A-140259M1 | MF | 202336M1 | A-202336M1 |
| MF | 140260M1 | A-140260M1 | MF | 203415M1 | A-203415M1 |
| MF | 141485M1 | A-141485M1 | MF | 204618M1 | A-204618M1 |
| MF | 141515M1 | A-141515M1 | MF | 210627M1 | A-210627M1 |
| MF | 141653M1 | A-141653M1 | MF | 210628C1 | A-210628C1 |
| MF | 141654M1 | A-141654M1 | MF | 210635M1 | A-210635M1 |
| MF | 141883M1 | A-141883M1 | MF | 210810M1 | A-210810M1 |
| MF | 141899M1 | A-141899M1 | MF | 211097M1 | A-211097M1 |
| MF | 1445437M1 | A-1445437M1 | MF | 211666M1 | A-211666M1 |
| MF | 1446201M1 | A-1446201M1 | MF | 213008M1 | A-213008M1 |





MF: Massey Ferguson

MASSEY FERGUSON (MF)

| OEM | OEM  Part No. | PIX  Part No. | OEM | OEM  Part No. | PIX  Part No. |
|-----|--|--|-----|--|--|
| MF | 213850M1 | A-213850M1 | MF | 2614A158 | A-2614A158 |
| MF | 216286M1 | A-216286M1 | MF | 2614B145 | A-2614B145 |
| MF | 216897M1 | A-216897M1 | MF | 2614B650 | A-2614B650 |
| MF | 220773M1 | A-220773M1 | MF | 2727160M2 | A-2727160M2 |
| MF | 222295M1 | A-222295M1 | MF | 273757 | A-273757 |
| MF | 222347M1 | A-222347M1 | MF | 273757M1 | A-273757M1 |
| MF | 222666M1 | A-222666M1 | MF | 274252M91 | A-274252M91 |
| MF | 222882M1 | A-222882M1 | MF | 2826795M1 | A-2826795M1 |
| MF | 222917M1 | A-222917M1 | MF | 2827362M3 | A-2827362M3 |
| MF | 223006M1 | A-223006M1 | MF | 282779M1 | A-282779M1 |
| MF | 226848 | A-226848 | MF | 283080M1 | A-283080M1 |
| MF | 226848M1 | A-226848M1 | MF | 2833904M2 | A-2833904M2 |
| MF | 227978M1 | A-227978M1 | MF | 2833904M3 | A-2833904M3 |
| MF | 227986 | A-227986 | MF | 2834466M1 | A-2834466M1 |
| MF | 227986M1 | A-227986M1 | MF | 2835234M1 | A-2835234M1 |
| MF | 228113M1 | A-228113M1 | MF | 2835857M1 | A-2835857M1 |
| MF | 228147M9 | A-228147M9 | MF | 2835858M1 | A-2835858M1 |
| MF | 228147M91 | A-228147M91 | MF | 2837191M1 | A-2837191M1 |
| MF | 228722M1 | A-228722M1 | MF | 2839975M1 | A-2839975M1 |
| MF | 228813 | A-228813 | MF | 2839978M1 | A-2839978M1 |
| MF | 229097M1 | A-229097M1 | MF | 3021546M1 | A-3021546M1 |
| MF | 229458M1 | A-229458M1 | MF | 3034474 | A-3034474 |
| MF | 229863M1 | A-229863M1 | MF | 3034474M1 | A-3034474M1 |
| MF | 230097M1 | A-230097M1 | MF | 3055094M1 | A-3055094M1 |
| MF | 230350M1 | A-230350M1 | MF | 3098153M1 | A-3098153M1 |
| MF | 230356M2 | A-230356M2 | MF | 3098211 | A-3098211 |
| MF | 2318 | A-2318 | MF | 3098212M1 | A-3098212M1 |
| MF | 232511M2 | A-232511M2 | MF | 3098212M2 | A-3098212M2 |
| MF | 233124 | A-233124 | MF | 3099082 | A-3099082 |
| MF | 233124M1 | A-233124M1 | MF | 3099082M1 | A-3099082M1 |
| MF | 233213M2 | A-233213M2 | MF | 3099829M1 | A-3099829M1 |
| MF | 233950 | A-233950 | MF | 3101337M1 | A-3101337M1 |
| MF | 234995M1 | A-234995M1 | MF | 31240417 | A-31-240417 |
| MF | 235199M1 | A-235199M1 | MF | 31244952 | A-31-244952 |
| MF | 236670M1 | A-236670M1 | MF | 31249611 | A-31-249611 |
| MF | 236958M1 | A-236958M1 | MF | 31255348 | A-31-255348 |
| MF | 236959M1 | A-236959M1 | MF | 3172001M1 | A-3172001M1 |
| MF | 238859M1 | A-238859M1 | MF | 3175109 | A-3175109 |
| MF | 238891M1 | A-238891M1 | MF | 3180838M1 | A-3180838M1 |
| MF | 240807M1 | A-240807M1 | MF | 3180869M1 | A-3180869M1 |
| MF | 244952M1 | A-244952M1 | MF | 320623M1 | A-320623M1 |
| MF | 252164M1 | A-252164M1 | MF | 3226971M1 | A-3226971M1 |
| MF | 252828950 | A-252828950 | MF | 3287277M1 | A-3287277M1 |
| MF | 252828950M1 | A-252828950M1 | MF | 3288911 | A-3288911 |
| MF | 2543650M1 | A-2543650M1 | MF | 3288999V | A-3288999V |
| MF | 2543650W1 | A-2543650W1 | MF | 3289213 | A-3289213 |
| MF | 2612074 | A-2612074 | MF | 33143A | A-33143A |





MF: Massey Ferguson

MASSEY FERGUSON (MF)

| OEM | OEM  Part No. | PIX  Part No. | OEM | OEM  Part No. | PIX  Part No. |
|-----|--|--|-----|--|--|
| MF | 3315232 | A-3315232 | MF | 619317 | A-619317 |
| MF | 3315232M1 | A-3315232M1 | MF | 619317M1 | A-619317M1 |
| MF | 3439022M1 | A-3439022M1 | MF | 621262 | A-621262 |
| MF | 35615000 | A-35615000 | MF | 621320M1 | A-621320M1 |
| MF | 3568 | A-3568 | MF | 621321 | A-621321 |
| MF | 3616512M91 | A-3616512M91 | MF | 621321M1 | A-621321M1 |
| MF | 3617184M91 | A-3617184M91 | MF | 621588M1 | A-621588M1 |
| MF | 3637978M91 | A-3637978M91 | MF | 621646 | A-621646 |
| MF | 3640790M1 | A-3640790M1 | MF | 621646A | A-621646A |
| MF | 3669118M1 | A-3669118M1 | MF | 675576M1 | A-675576M1 |
| MF | 401109M1 | A-401109M1 | MF | 676135M1 | A-676135M1 |
| MF | 402607 | A-402607 | MF | 703321M1 | A-703321M1 |
| MF | 402608M1 | A-402608M1 | MF | 71188635 | A-71188635 |
| MF | 406888M1 | A-406888M1 | MF | 71322418 | A-71322418 |
| MF | 417441M1 | A-417441M1 | MF | 71396569 | A-71396569 |
| MF | 417441-M1 | A-417441-M1 | MF | 766861M1 | A-766861M1 |
| MF | 417995M1 | A-417995M1 | MF | 782523M1 | A-782523M1 |
| MF | 418192 | A-418192 | MF | 783539 | A-783539 |
| MF | 4273269M1 | A-4273269M1 | MF | 783539-M1 | A-783539-M1 |
| MF | 4275919M1 | A-4275919M1 | MF | 783907M2 | A-783907M2 |
| MF | 4286263M1 | A-4286263M1 | MF | 784170 | A-784170 |
| MF | 4288688M1 | A-4288688M1 | MF | 784170M1 | A-784170M1 |
| MF | 514891M1 | A-514891M1 | MF | 784170M2 | A-784170M2 |
| MF | 521398M91 | A-521398M91 | MF | 784796 | A-784796 |
| MF | 541190M1 | A-541190M1 | MF | 785585 | A-785585 |
| MF | 541390M1 | A-541390M1 | MF | 785585M1 | A-785585M1 |
| MF | 542304M1 | A-542304M1 | MF | 785806M2 | A-785806M2 |
| MF | 542551M1 | A-542551M1 | MF | 788317M1 | A-788317M1 |
| MF | 545000M1 | A-545000M1 | MF | 790833M1 | A-790833M1 |
| MF | 545644M1 | A-545644M1 | MF | 794129M1 | A-794129M1 |
| MF | 545650 | A-545650 | MF | 795514 | A-795514 |
| MF | 545651M1 | A-545651M1 | MF | 795582M1 | A-795582M1 |
| MF | 545652M1 | A-545652M1 | MF | 796487M1 | A-796487M1 |
| MF | 545654M1 | A-545654M1 | MF | 832446M1 | A-832446M1 |
| MF | 550321M1 | A-550321M1 | MF | 832789 | A-832789 |
| MF | 550596M1 | A-550596M1 | MF | 832789M1 | A-832789M1 |
| MF | 551251M1 | A-551251M1 | MF | 832789M2 | A-832789M2 |
| MF | 556779M91 | A-556779M91 | MF | 832790 | A-832790 |
| MF | 557292M1 | A-557292M1 | MF | 832790M1 | A-832790M1 |
| MF | 557514M1 | A-557514M1 | MF | 832822M1 | A-832822M1 |
| MF | 557514M2 | A-557514M2 | MF | 832855M1 | A-832855M1 |
| MF | 557784M1 | A-557784M1 | MF | 832866M1 | A-832866M1 |
| MF | 559808M1 | A-559808M1 | MF | 832869M1 | A-832869M1 |
| MF | 560667M1 | A-560667M1 | MF | 832870M1 | A-832870M1 |
| MF | 561800M1 | A-561800M1 | MF | 832872M1 | A-832872M1 |
| MF | 566844M91 | A-566844M91 | MF | 832876M1 | A-832876M1 |
| MF | 619212M1 | A-619212M1 | MF | 832895M2 | A-832895M2 |





MF: Massey Ferguson

MASSEY FERGUSON (MF)

| OEM | OEM  Part No. | PIX  Part No. | OEM | OEM  Part No. | PIX  Part No. |
|-----|--|--|-----|--|--|
| MF | 832896M1 | A-832896M1 | MF | 905921 | A-905921 |
| MF | 833061M1 | A-833061M1 | MF | 905921A | A-905921A |
| MF | 833127M1 | A-833127M1 | MF | 912717M1 | A-912717M1 |
| MF | 833128M1 | A-833128M1 | MF | 923639M1 | A-923639M1 |
| MF | 833130M1 | A-833130M1 | MF | 923640M1 | A-923640M1 |
| MF | 833131M1 | A-833131M1 | MF | 923802M2 | A-923802M2 |
| MF | 833137M1 | A-833137M1 | MF | 923971M2 | A-923971M2 |
| MF | 833563M1 | A-833563M1 | MF | 924327M1 | A-924327M1 |
| MF | 833655M2 | A-833655M2 | MF | 924329M1 | A-924329M1 |
| MF | 833665M1 | A-833665M1 | MF | 924623M1 | A-924623M1 |
| MF | 833742M1 | A-833742M1 | MF | 924698M1 | A-924698M1 |
| MF | 833854 | A-833854 | MF | 924698M2 | A-924698M2 |
| MF | 833857 | A-833857 | MF | 924769M2 | A-924769M2 |
| MF | 833858 | A-833858 | MF | 925216M1 | A-925216M1 |
| MF | 833859 | A-833859 | MF | 926755M1 | A-926755M1 |
| MF | 833862 | A-833862 | MF | 926781M1 | A-926781M1 |
| MF | 833862M1 | A-833862M1 | MF | 926838M1 | A-926838M1 |
| MF | 833863 | A-833863 | MF | 926838M2 | A-926838M2 |
| MF | 833865 | A-833865 | MF | 927210M1 | A-927210M1 |
| MF | 833866 | A-833866 | MF | 927739M1 | A-927739M1 |
| MF | 833868A | A-833868A | MF | 933139M1 | A-933139M1 |
| MF | 833868M1 | A-833868M1 | MF | 933245M1 | A-933245M1 |
| MF | 833871 | A-833871 | MF | 933505M1 | A-933505M1 |
| MF | 833873 | A-833873 | MF | 947580M1 | A-947580M1 |
| MF | 833874 | A-833874 | MF | 947581M1 | A-947581M1 |
| MF | 833875M1 | A-833875M1 | MF | D41904200 | A-D41904200 |
| MF | 834032M1 | A-834032M1 | MF | D41909000 | A-D41909000 |
| MF | 834057M1 | A-834057M1 | MF | D41911000 | A-D41911000 |
| MF | 834060M1 | A-834060M1 | MF | D41912400 | A-D41912400 |
| MF | 834063M1 | A-834063M1 | MF | D41916800 | A-D41916800 |
| MF | 834110 | A-834110 | MF | D41928100 | A-D41928100 |
| MF | 834110-M1 | A-834110-M1 | MF | D41929000 | A-D41929000 |
| MF | 834148M1 | A-834148M1 | MF | D41930200 | A-D41930200 |
| MF | 834174 | A-834174 | MF | D41933700 | A-D41933700 |
| MF | 834265M1 | A-834265M1 | MF | D41936200 | A-D41936200 |
| MF | 842413 | A-842413 | MF | D41936700 | A-D41936700 |
| MF | 842419M1 | A-842419M1 | MF | D41936800 | A-D41936800 |
| MF | 842851M1 | A-842851M1 | MF | D41937800 | A-D41937800 |
| MF | 843009M1 | A-843009M1 | MF | D41942100 | A-D41942100 |
| MF | 843310 | A-843310 | MF | D41942200 | A-D41942200 |
| MF | 843313 | A-843313 | MF | D41943600 | A-D41943600 |
| MF | 843313M1 | A-843313M1 | MF | D41950100 | A-D41950100 |
| MF | 843732 | A-843732 | MF | D41950400 | A-D41950400 |
| MF | 843732M1 | A-843732M1 | MF | D41963900 | A-D41963900 |
| MF | 843747 | A-843747 | MF | D41979000 | A-D41979000 |
| MF | 844461M1 | A-844461M1 | MF | D41979200 | A-D41979200 |
| MF | 905920 | A-905920 | MF | D41979400 | A-D41979400 |



MF: Massey Ferguson

MASSEY FERGUSON (MF)



| OEM | OEM  Part No. | PIX  Part No. | OEM | OEM  Part No. | PIX  Part No. |
|-----|--|--|-----|--|--|
| MF | D41979600 | A-D41979600 | MF | V684120900 | A-V684120900 |
| MF | D41980400 | A-D41980400 | MF | V684121475 | A-V684121475 |
| MF | D41980500 | A-D41980500 | MF | V685121570 | A-V685121570 |
| MF | D41981300 | A-D41981300 | MF | V685121880 | A-V685121880 |
| MF | D41981400 | A-D41981400 | MF | V836859262 | A-V836859262 |
| MF | D41981500 | A-D41981500 | MF | 229096M1 | A-229096M1 |
| MF | D41982000 | A-D41982000 | | | |
| MF | D41982100 | A-D41982100 | | | |
| MF | D41982300 | A-D41982300 | | | |
| MF | D41982400 | A-D41982400 | | | |
| MF | D41982600 | A-D41982600 | | | |
| MF | D41983300 | A-D41983300 | | | |
| MF | D41983500 | A-D41983500 | | | |
| MF | D41983600 | A-D41983600 | | | |
| MF | D41984100 | A-D41984100 | | | |
| MF | D41985300 | A-D41985300 | | | |
| MF | D41985900 | A-D41985900 | | | |
| MF | D41986100 | A-D41986100 | | | |
| MF | D41986200 | A-D41986200 | | | |
| MF | D41986300 | A-D41986300 | | | |
| MF | D41987300 | A-D41987300 | | | |
| MF | D41987600 | A-D41987600 | | | |
| MF | D41987900 | A-D41987900 | | | |
| MF | D41989200 | A-D41989200 | | | |
| MF | D41989800 | A-D41989800 | | | |
| MF | D41990011 | A-D41990011 | | | |
| MF | D41990012 | A-D41990012 | | | |
| MF | D41990013 | A-D41990013 | | | |
| MF | D41990048 | A-D41990048 | | | |
| MF | D41990050 | A-D41990050 | | | |
| MF | D41990054 | A-D41990054 | | | |
| MF | D41990056 | A-D41990056 | | | |
| MF | D41990061 | A-D41990061 | | | |
| MF | D41990064 | A-D41990064 | | | |
| MF | D41990068 | A-D41990068 | | | |
| MF | D41990100 | A-D41990100 | | | |
| MF | D41990200 | A-D41990200 | | | |
| MF | D41990400 | A-D41990400 | | | |
| MF | D41990700 | A-D41990700 | | | |
| MF | D41991000 | A-D41991000 | | | |
| MF | D41991300 | A-D41991300 | | | |
| MF | D41991700 | A-D41991700 | | | |
| MF | GB5314 | A-GB5314 | | | |
| MF | GH5045 | A-GH5045 | | | |
| MF | GH5046 | A-GH5046 | | | |
| MF | GK5105 | A-GK5105 | | | |
| MF | TX52186 | A-TX52186 | | | |

MF: Massey Ferguson





MENGELE

| OEM | OEM  Part No. | PIX  Part No. |
|---------|--|--|
| MENGELE | 98036276 | A-98036276 |
| MENGELE | 98029383 | A-98029383 |
| MENGELE | 98029384 | A-98029384 |
| MENGELE | 98018167 | A-98018167 |
| MENGELE | 98025521 | A-98025521 |
| MENGELE | 98021123 | A-98021123 |
| MENGELE | 98022200 | A-98022200 |
| MENGELE | 98022731 | A-98022731 |
| MENGELE | 98042619 | A-98042619 |
| MENGELE | 98014367 | A-98014367 |
| MENGELE | 98026937 | A-98026937 |
| MENGELE | 98042380 | A-98042380 |
| MENGELE | 98042202 | A-98042202 |
| MENGELE | 98006272 | A-98006272 |
| MENGELE | 98028271 | A-98028271 |
| MENGELE | 98020849 | A-98020849 |
| MENGELE | 98011048 | A-98011048 |
| MENGELE | 98028266 | A-98028266 |
| MENGELE | 98028267 | A-98028267 |
| MENGELE | 98028268 | A-98028268 |
| MENGELE | 98022265 | A-98022265 |
| MENGELE | 98017686 | A-98017686 |
| MENGELE | 98028264 | A-98028264 |
| MENGELE | 98041414 | A-98041414 |
| MENGELE | 98023422 | A-98023422 |
| MENGELE | 98031590 | A-98031590 |
| MENGELE | 98031801 | A-98031801 |
| MENGELE | 98042442 | A-98042442 |
| MENGELE | 98039955 | A-98039955 |
| MENGELE | 98036045 | A-98036045 |
| MENGELE | 98041779 | A-98041779 |
| MENGELE | 98031803 | A-98031803 |
| MENGELE | 98043776 | A-98043776 |
| MENGELE | 98043777 | A-98043777 |
| MENGELE | 98043775 | A-98043775 |
| MENGELE | 98041435 | A-98041435 |
| MENGELE | 98028534 | A-98028534 |
| MENGELE | 98042197 | A-98042197 |
| MENGELE | 98031800 | A-98031800 |
| MENGELE | 98045896 | A-98045896 |





PÖTTINGER

| OEM | OEM  Part No. | PIX  Part No. |
|-----------|--|--|
| PÖTTINGER | 460216 | A-460216 |
| PÖTTINGER | 460217 | A-460217 |
| PÖTTINGER | 460218 | A-460218 |
| PÖTTINGER | 460195 | A-460195 |
| PÖTTINGER | 460194 | A-460194 |
| PÖTTINGER | 460222 | A-460222 |
| PÖTTINGER | 460197 | A-460197 |
| PÖTTINGER | 460196 | A-460196 |
| PÖTTINGER | 460223 | A-460223 |
| PÖTTINGER | 460212 | A-460212 |
| PÖTTINGER | 460411 | A-460411 |
| PÖTTINGER | 460412 | A-460412 |
| PÖTTINGER | 460013 | A-460013 |
| PÖTTINGER | 460413 | A-460413 |
| PÖTTINGER | 460231 | A-460231 |
| PÖTTINGER | 460201 | A-460201 |
| PÖTTINGER | 460253 | A-460253 |
| PÖTTINGER | 460452 | A-460452 |
| PÖTTINGER | 460047 | A-460047 |
| PÖTTINGER | 460057 | A-460057 |
| PÖTTINGER | 460062 | A-460062 |
| PÖTTINGER | 460061 | A-460061 |
| PÖTTINGER | 460066 | A-460066 |
| PÖTTINGER | 460063 | A-460063 |
| PÖTTINGER | 460186 | A-460186 |
| PÖTTINGER | 460184 | A-460184 |
| PÖTTINGER | 460188 | A-460188 |
| PÖTTINGER | 460189 | A-460189 |
| PÖTTINGER | 460198 | A-460198 |
| PÖTTINGER | 460192 | A-460192 |
| PÖTTINGER | 460199 | A-460199 |
| PÖTTINGER | 460409 | A-460409 |
| PÖTTINGER | 460259 | A-460259 |
| PÖTTINGER | 460420 | A-460420 |
| PÖTTINGER | 460048 | A-460048 |
| PÖTTINGER | 460056 | A-460056 |
| PÖTTINGER | 460408 | A-460408 |
| PÖTTINGER | 460453 | A-460453 |
| PÖTTINGER | 460055 | A-460055 |
| PÖTTINGER | 460000025 | A-460000025 |
| PÖTTINGER | 460000026 | A-460000026 |





ROSTSELMASH

| OEM | OEM  Part No. | PIX  Part No. | OEM | OEM  Part No. | PIX  Part No. |
|-------------|--|--|-------------|--|--|
| ROSTSELMASH | 6201381 | A-6201381 | ROSTSELMASH | 6201413 | A-6201413 |
| ROSTSELMASH | 6201406 | A-6201406 | ROSTSELMASH | 6201195 | A-6201195 |
| ROSTSELMASH | 6201417 | A-6201417 | ROSTSELMASH | 6201408 | A-6201408 |
| ROSTSELMASH | 6201401 | A-6201401 | ROSTSELMASH | 6201196 | A-6201196 |
| ROSTSELMASH | 6201005 | A-6201005 | ROSTSELMASH | 6201085 | A-6201085 |
| ROSTSELMASH | 6201405 | A-6201405 | ROSTSELMASH | 6201322 | A-6201322 |
| ROSTSELMASH | 6201412 | A-6201412 | ROSTSELMASH | 6201320 | A-6201320 |
| ROSTSELMASH | 6201097 | A-6201097 | ROSTSELMASH | 6201083 | A-6201083 |
| ROSTSELMASH | 6201315 | A-6201315 | ROSTSELMASH | 6201418 | A-6201418 |
| ROSTSELMASH | 6201356 | A-6201356 | ROSTSELMASH | 6201416 | A-6201416 |
| ROSTSELMASH | 6201357 | A-6201357 | ROSTSELMASH | 6201422 | A-6201422 |
| ROSTSELMASH | 6201349 | A-6201349 | ROSTSELMASH | 6201081 | A-6201081 |
| ROSTSELMASH | 6201358 | A-6201358 | ROSTSELMASH | 6201414 | A-6201414 |
| ROSTSELMASH | 6201022 | A-6201022 | ROSTSELMASH | 6201387 | A-6201387 |
| ROSTSELMASH | 6201342 | A-6201342 | ROSTSELMASH | 6201324 | A-6201324 |
| ROSTSELMASH | 6201023 | A-6201023 | ROSTSELMASH | 6201396 | A-6201396 |
| ROSTSELMASH | 6201350 | A-6201350 | ROSTSELMASH | 6201421 | A-6201421 |
| ROSTSELMASH | 6201006 | A-6201006 | ROSTSELMASH | 6201339 | A-6201339 |
| ROSTSELMASH | 6201382 | A-6201382 | ROSTSELMASH | 6201087 | A-6201087 |
| ROSTSELMASH | 6201397 | A-6201397 | ROSTSELMASH | 6201091 | A-6201091 |
| ROSTSELMASH | 6201383 | A-6201383 | ROSTSELMASH | 6201277 | A-6201277 |
| ROSTSELMASH | 6201419 | A-6201419 | ROSTSELMASH | 6201298 | A-6201298 |
| ROSTSELMASH | 6201363 | A-6201363 | ROSTSELMASH | 6201080 | A-6201080 |
| ROSTSELMASH | 6201317 | A-6201317 | ROSTSELMASH | 6201411 | A-6201411 |
| ROSTSELMASH | 6201330 | A-6201330 | ROSTSELMASH | 6201432 | A-6201432 |
| ROSTSELMASH | 6201084 | A-6201084 | ROSTSELMASH | 6201393 | A-6201393 |
| ROSTSELMASH | 6201404 | A-6201404 | ROSTSELMASH | 6201426 | A-6201426 |
| ROSTSELMASH | 6201424 | A-6201424 | ROSTSELMASH | 6201380 | A-6201380 |
| ROSTSELMASH | 6201392 | A-6201392 | ROSTSELMASH | 6201379 | A-6201379 |
| ROSTSELMASH | 6201029 | A-6201029 | ROSTSELMASH | 6201384 | A-6201384 |
| ROSTSELMASH | 6201400 | A-6201400 | ROSTSELMASH | 6201403 | A-6201403 |
| ROSTSELMASH | 6201089 | A-6201089 | ROSTSELMASH | 6201461 | A-6201461 |
| ROSTSELMASH | 6201420 | A-6201420 | ROSTSELMASH | 6201437 | A-6201437 |
| ROSTSELMASH | 6201318 | A-6201318 | ROSTSELMASH | 6201428 | A-6201428 |
| ROSTSELMASH | 6201088 | A-6201088 | | | |
| ROSTSELMASH | 6201340 | A-6201340 | | | |
| ROSTSELMASH | 6201096 | A-6201096 | | | |
| ROSTSELMASH | 6201373 | A-6201373 | | | |
| ROSTSELMASH | 6201415 | A-6201415 | | | |
| ROSTSELMASH | 6201086 | A-6201086 | | | |
| ROSTSELMASH | 6201265 | A-6201265 | | | |
| ROSTSELMASH | 6201319 | A-6201319 | | | |
| ROSTSELMASH | 6201335 | A-6201335 | | | |
| ROSTSELMASH | 6201399 | A-6201399 | | | |
| ROSTSELMASH | 6201329 | A-6201329 | | | |
| ROSTSELMASH | 6201341 | A-6201341 | | | |
| ROSTSELMASH | 6201394 | A-6201394 | | | |





SAME-DEUTZ-FAHR (SDF)

| OEM | OEM  Part No. | PIX  Part No. | OEM | OEM  Part No. | PIX  Part No. |
|-----|--|--|-----|--|--|
| SDF | 6215221 | A-6215221 | SDF | 6212900 | A-6212900 |
| SDF | 1145790 | A-1145790 | SDF | 1145959 | A-1145959 |
| SDF | 1181126 | A-1181126 | SDF | 1145625 | A-1145625 |
| SDF | 1145504 | A-1145504 | SDF | 1116094 | A-1116094 |
| SDF | 2235056 | A-2235056 | SDF | 1141788 | A-1141788 |
| SDF | 6528420 | A-6528420 | SDF | 1145940 | A-1145940 |
| SDF | 6215249 | A-6215249 | SDF | 6210894 | A-6210894 |
| SDF | 6215235 | A-6215235 | SDF | 1145977 | A-1145977 |
| SDF | 6255583 | A-6255583 | SDF | 1145782 | A-1145782 |
| SDF | 6212918 | A-6212918 | SDF | 1145725 | A-1145725 |
| SDF | 6241147 | A-6241147 | SDF | 1116095 | A-1116095 |
| SDF | 6211026 | A-6211026 | SDF | 1145685 | A-1145685 |
| SDF | 6211031 | A-6211031 | SDF | 1145631 | A-1145631 |
| SDF | 6215215 | A-6215215 | SDF | 1116096 | A-1116096 |
| SDF | 2235256 | A-2235256 | SDF | 1145973 | A-1145973 |
| SDF | 4342249 | A-4342249 | SDF | 1100903 | A-1100903 |
| SDF | 4325382 | A-4325382 | SDF | 6256381 | A-6256381 |
| SDF | 1397776 | A-1397776 | SDF | 1145214 | A-1145214 |
| SDF | 6212834 | A-6212834 | SDF | 6210904 | A-6210904 |
| SDF | 6228207 | A-6228207 | SDF | 6256547 | A-6256547 |
| SDF | 6580119 | A-6580119 | SDF | 6210906 | A-6210906 |
| SDF | 6580049 | A-6580049 | SDF | 1145215 | A-1145215 |
| SDF | 6212833 | A-6212833 | SDF | 6210912 | A-6210912 |
| SDF | 1168304 | A-1168304 | SDF | 1145989 | A-1145989 |
| SDF | 1160990 | A-1160990 | SDF | 6210913 | A-6210913 |
| SDF | 1163087 | A-1163087 | SDF | 1116097 | A-1116097 |
| SDF | 1145921 | A-1145921 | SDF | 6210915 | A-6210915 |
| SDF | 1145970 | A-1145970 | SDF | 6210916 | A-6210916 |
| SDF | 1162717 | A-1162717 | SDF | 6210918 | A-6210918 |
| SDF | 6204283 | A-6204283 | SDF | 1145003 | A-1145003 |
| SDF | 1116063 | A-1116063 | SDF | 6210919 | A-6210919 |
| SDF | 6210869 | A-6210869 | SDF | 1145216 | A-1145216 |
| SDF | 6210870 | A-6210870 | SDF | 1141840 | A-1141840 |
| SDF | 1145367 | A-1145367 | SDF | 6210921 | A-6210921 |
| SDF | 1116060 | A-1116060 | SDF | 1141765 | A-1141765 |
| SDF | 1116062 | A-1116062 | SDF | 6210924 | A-6210924 |
| SDF | 1116080 | A-1116080 | SDF | 6210925 | A-6210925 |
| SDF | 6210880 | A-6210880 | SDF | 1145697 | A-1145697 |
| SDF | 6210881 | A-6210881 | SDF | 1143497 | A-1143497 |
| SDF | 1116089 | A-1116089 | SDF | 1141850 | A-1141850 |
| SDF | 1116091 | A-1116091 | SDF | 6210853 | A-6210853 |
| SDF | 1397850 | A-1397850 | SDF | 1145263 | A-1145263 |
| SDF | 1116092 | A-1116092 | SDF | 1145218 | A-1145218 |
| SDF | 1145960 | A-1145960 | SDF | 6210929 | A-6210929 |
| SDF | 6210889 | A-6210889 | SDF | 6210930 | A-6210930 |
| SDF | 1145047 | A-1145047 | SDF | 6210874 | A-6210874 |
| SDF | 1116093 | A-1116093 | SDF | 6204315 | A-6204315 |





SAME-DEUTZ-FAHR (SDF)

| OEM | OEM  Part No. | PIX  Part No. | OEM | OEM  Part No. | PIX  Part No. |
|-----|--|--|-----|--|--|
| SDF | 6204317 | A-6204317 | SDF | 1397596 | A-1397596 |
| SDF | 6204318 | A-6204318 | SDF | 6210973 | A-6210973 |
| SDF | 6204325 | A-6204325 | SDF | 6210977 | A-6210977 |
| SDF | 6204326 | A-6204326 | SDF | 6210978 | A-6210978 |
| SDF | 6204327 | A-6204327 | SDF | 1139079 | A-1139079 |
| SDF | 6204329 | A-6204329 | SDF | 1116131 | A-1116131 |
| SDF | 6212909 | A-6212909 | SDF | 6210981 | A-6210981 |
| SDF | 6212919 | A-6212919 | SDF | 1141938 | A-1141938 |
| SDF | 6242124 | A-6242124 | SDF | 1139080 | A-1139080 |
| SDF | 6254069 | A-6254069 | SDF | 6210984 | A-6210984 |
| SDF | 6254070 | A-6254070 | SDF | 1139081 | A-1139081 |
| SDF | 6204310 | A-6204310 | SDF | 1145738 | A-1145738 |
| SDF | 6214290 | A-6214290 | SDF | 6210986 | A-6210986 |
| SDF | 1116113 | A-1116113 | SDF | 1145449 | A-1145449 |
| SDF | 6210932 | A-6210932 | SDF | 1141770 | A-1141770 |
| SDF | 1116114 | A-1116114 | SDF | 6210988 | A-6210988 |
| SDF | 6210934 | A-6210934 | SDF | 6210989 | A-6210989 |
| SDF | 6210938 | A-6210938 | SDF | 6204291 | A-6204291 |
| SDF | 6210939 | A-6210939 | SDF | 1141882 | A-1141882 |
| SDF | 6210941 | A-6210941 | SDF | 1145203 | A-1145203 |
| SDF | 6210943 | A-6210943 | SDF | 1141917 | A-1141917 |
| SDF | 1139070 | A-1139070 | SDF | 1141622 | A-1141622 |
| SDF | 6210947 | A-6210947 | SDF | 1145143 | A-1145143 |
| SDF | 1139071 | A-1139071 | SDF | 6210992 | A-6210992 |
| SDF | 6204289 | A-6204289 | SDF | 1145505 | A-1145505 |
| SDF | 6210951 | A-6210951 | SDF | 1145462 | A-1145462 |
| SDF | 6210953 | A-6210953 | SDF | 6210994 | A-6210994 |
| SDF | 6210954 | A-6210954 | SDF | 1141373 | A-1141373 |
| SDF | 6210955 | A-6210955 | SDF | 1141958 | A-1141958 |
| SDF | 6210957 | A-6210957 | SDF | 1142150 | A-1142150 |
| SDF | 1139073 | A-1139073 | SDF | 1145461 | A-1145461 |
| SDF | 1139074 | A-1139074 | SDF | 6210996 | A-6210996 |
| SDF | 6210960 | A-6210960 | SDF | 1145884 | A-1145884 |
| SDF | 1139076 | A-1139076 | SDF | 1141758 | A-1141758 |
| SDF | 6210963 | A-6210963 | SDF | 1141626 | A-1141626 |
| SDF | 6204295 | A-6204295 | SDF | 6210997 | A-6210997 |
| SDF | 1139078 | A-1139078 | SDF | 1141894 | A-1141894 |
| SDF | 1141554 | A-1141554 | SDF | 1139082 | A-1139082 |
| SDF | 3210969 | A-3210969 | SDF | 6210999 | A-6210999 |
| SDF | 6210969 | A-6210969 | SDF | 1141643 | A-1141643 |
| SDF | 1139252 | A-1139252 | SDF | 1139083 | A-1139083 |
| SDF | 1179132 | A-1179132 | SDF | 6211001 | A-6211001 |
| SDF | 1339252 | A-1339252 | SDF | 1139084 | A-1139084 |
| SDF | 6210970 | A-6210970 | SDF | 6211003 | A-6211003 |
| SDF | 6210971 | A-6210971 | SDF | 1145186 | A-1145186 |
| SDF | 1145990 | A-1145990 | SDF | 6211004 | A-6211004 |
| SDF | 1145699 | A-1145699 | SDF | 1145792 | A-1145792 |





SAME-DEUTZ-FAHR (SDF)

| OEM | OEM  Part No. | PIX  Part No. | OEM | OEM  Part No. | PIX  Part No. |
|-----|--|--|-----|--|--|
| SDF | 1141823 | A-1141823 | SDF | 6204296 | A-6204296 |
| SDF | 1145949 | A-1145949 | SDF | 6204297 | A-6204297 |
| SDF | 1139301 | A-1139301 | SDF | 4453084 | A-4453084 |
| SDF | 1145481 | A-1145481 | SDF | 1180447 | A-1180447 |
| SDF | 6211006 | A-6211006 | SDF | 1180448 | A-1180448 |
| SDF | 1139085 | A-1139085 | SDF | 1180450 | A-1180450 |
| SDF | 1141798 | A-1141798 | SDF | 1181260 | A-1181260 |
| SDF | 1139086 | A-1139086 | SDF | 4437549 | A-4437549 |
| SDF | 1145633 | A-1145633 | SDF | 1145937 | A-1145937 |
| SDF | 6273237 | A-6273237 | SDF | 1145262 | A-1145262 |
| SDF | 1141644 | A-1141644 | SDF | 16031538 | A-16031538 |
| SDF | 1231688 | A-1231688 | SDF | 1145260 | A-1145260 |
| SDF | 6211009 | A-6211009 | SDF | 16015922 | A-16015922 |
| SDF | 1231696 | A-1231696 | SDF | 1145667 | A-1145667 |
| SDF | 6211010 | A-6211010 | SDF | 6204334 | A-6204334 |
| SDF | 1231697 | A-1231697 | SDF | 1141816 | A-1141816 |
| SDF | 1145335 | A-1145335 | SDF | 6215231 | A-6215231 |
| SDF | 6257897 | A-6257897 | SDF | 1141819 | A-1141819 |
| SDF | 1145922 | A-1145922 | SDF | 1141918 | A-1141918 |
| SDF | 1139088 | A-1139088 | SDF | 1145226 | A-1145226 |
| SDF | 6204304 | A-6204304 | SDF | 6215236 | A-6215236 |
| SDF | 6211016 | A-6211016 | SDF | 6215242 | A-6215242 |
| SDF | 1104054 | A-1104054 | SDF | 6215241 | A-6215241 |
| SDF | 6211019 | A-6211019 | SDF | 6215234 | A-6215234 |
| SDF | 6211020 | A-6211020 | SDF | 1141503 | A-1141503 |
| SDF | 6211023 | A-6211023 | SDF | 1141624 | A-1141624 |
| SDF | 6211053 | A-6211053 | SDF | 1141625 | A-1141625 |
| SDF | 6211024 | A-6211024 | SDF | 1141502 | A-1141502 |
| SDF | 6211025 | A-6211025 | SDF | 1145632 | A-1145632 |
| SDF | 6211027 | A-6211027 | SDF | 1145750 | A-1145750 |
| SDF | 1139089 | A-1139089 | SDF | 6215195 | A-6215195 |
| SDF | 6204322 | A-6204322 | SDF | 1145724 | A-1145724 |
| SDF | 6211032 | A-6211032 | SDF | 1141762 | A-1141762 |
| SDF | 6211033 | A-6211033 | SDF | 6215206 | A-6215206 |
| SDF | 6211034 | A-6211034 | SDF | 1145590 | A-1145590 |
| SDF | 1139090 | A-1139090 | SDF | 1141792 | A-01141792 |
| SDF | 1139091 | A-1139091 | SDF | 1145457 | A-1145457 |
| SDF | 1139092 | A-1139092 | SDF | 1145261 | A-1145261 |
| SDF | 6211041 | A-6211041 | SDF | 1141912 | A-1141912 |
| SDF | 6211042 | A-6211042 | SDF | 1145458 | A-1145458 |
| SDF | 6211043 | A-6211043 | SDF | 1174974 | A-1174974 |
| SDF | 1139093 | A-1139093 | SDF | 1141909 | A-1141909 |
| SDF | 6211046 | A-6211046 | SDF | 1145690 | A-1145690 |
| SDF | 6204335 | A-6204335 | SDF | 1145866 | A-1145866 |
| SDF | 6204333 | A-6204333 | SDF | 1145751 | A-1145751 |
| SDF | 6204332 | A-6204332 | SDF | 6204307 | A-6204307 |
| SDF | 6215219 | A-6215219 | SDF | 6204311 | A-6204311 |





SAME-DEUTZ-FAHR (SDF)

| OEM | OEM  Part No. | PIX  Part No. | OEM | OEM  Part No. | PIX  Part No. |
|-----|--|--|-----|--|--|
| SDF | 16015923 | A-16015923 | SDF | 2235421 | A-2235421 |
| SDF | 1145459 | A-1145459 | SDF | 1182429 | A-1182429 |
| SDF | 1145865 | A-1145865 | SDF | 1182429 | A-1182429 |
| SDF | 1145660 | A-1145660 | SDF | 4435634 | A-4435634 |
| SDF | 1145689 | A-1145689 | SDF | 1145668 | A-1145668 |
| SDF | 4452089 | A-4452089 | SDF | 1154357 | A-1154357 |
| SDF | 4452089 | A-4452089 | SDF | 1168325 | A-1168325 |
| SDF | 4454180 | A-04454180 | SDF | 1175765 | A-1175765 |
| SDF | 6215212 | A-6215212 | SDF | 1176330 | A-1176330 |
| SDF | 6215226 | A-6215226 | SDF | 1180516 | A-1180516 |
| SDF | 16042133 | A-16042133 | SDF | 1180517 | A-1180517 |
| SDF | 16031403 | A-16031403 | SDF | 1180848 | A-1180848 |
| SDF | 1145680 | A-1145680 | SDF | 1181185 | A-1181185 |
| SDF | 1145742 | A-1145742 | SDF | 2419104 | A-2419104 |
| SDF | 1145744 | A-1145744 | SDF | 4305745 | A-4305745 |
| SDF | 1145628 | A-1145628 | SDF | 4325871 | A-4325871 |
| SDF | 4455253 | A-4455253 | SDF | 4343181 | A-4343181 |
| SDF | 2235531 | A-02235531 | SDF | 4359336 | A-4359336 |
| SDF | 1139214 | A-1139214 | SDF | 4437559 | A-4437559 |
| SDF | 1139215 | A-1139215 | SDF | 4437560 | A-4437560 |
| SDF | 1139216 | A-1139216 | SDF | 4438414 | A-4438414 |
| SDF | 1139217 | A-1139217 | SDF | 4450657 | A-4450657 |
| SDF | 1139218 | A-1139218 | SDF | 4452801 | A-4452801 |
| SDF | 1139219 | A-1139219 | SDF | 4455177 | A-4455177 |
| SDF | 1139220 | A-1139220 | SDF | 16029939 | A-16029939 |
| SDF | 1139221 | A-1139221 | SDF | 1175765 | A-1175765 |
| SDF | 1139222 | A-1139222 | SDF | 1180516 | A-1180516 |
| SDF | 1181366 | A-1181366 | SDF | 1180517 | A-1180517 |
| SDF | 2231579 | A-2231579 | SDF | 1181185 | A-1181185 |
| SDF | 2235175 | A-2235175 | SDF | 4325871 | A-4325871 |
| SDF | 2235176 | A-2235176 | SDF | 4359336 | A-4359336 |
| SDF | 2235178 | A-2235178 | SDF | 4438414 | A-4438414 |
| SDF | 2235179 | A-2235179 | SDF | 4455177 | A-4455177 |
| SDF | 2235181 | A-2235181 | SDF | 1180553 | A-1180553 |
| SDF | 2235254 | A-2235254 | SDF | 4452440 | A-4452440 |
| SDF | 2235255 | A-2235255 | SDF | 6212871 | A-6212871 |
| SDF | 2235421 | A-2235421 | SDF | 6212872 | A-6212872 |
| SDF | 2235533 | A-2235533 | SDF | 6204284 | A-6204284 |
| SDF | 2239152 | A-2239152 | SDF | 6212874 | A-6212874 |
| SDF | 6212847 | A-6212847 | SDF | 1139300 | A-1139300 |
| SDF | 6212850 | A-6212850 | SDF | 1139234 | A-1139234 |
| SDF | 6212851 | A-6212851 | SDF | 6204287 | A-6204287 |
| SDF | 6212852 | A-6212852 | SDF | 6298998 | A-6298998 |
| SDF | 2235175 | A-2235175 | SDF | 6204285 | A-6204285 |
| SDF | 2235178 | A-2235178 | SDF | 6204286 | A-6204286 |
| SDF | 2235179 | A-2235179 | SDF | 6204288 | A-6204288 |
| SDF | 2235181 | A-2235181 | SDF | 6212883 | A-6212883 |





SAME-DEUTZ-FAHR (SDF)

| OEM | OEM  Part No. | PIX  Part No. | OEM | OEM  Part No. | PIX  Part No. |
|-----|--|--|-----|--|--|
| SDF | 6212885 | A-6212885 | SDF | 1145802 | A-1145802 |
| SDF | 1139235 | A-1139235 | SDF | 16617104 | A-16617104 |
| SDF | 1139237 | A-1139237 | SDF | 1142840 | A-1142840 |
| SDF | 6212890 | A-6212890 | SDF | 0.0183111.0 | A-.0183111.0 |
| SDF | 1145823 | A-1145823 | SDF | 2.4119.211.0 | A-2.4119.211.0 |
| SDF | 6212894 | A-6212894 | SDF | 0.018.3550.0 | A-.018.3550.0 |
| SDF | 1141818 | A-1141818 | SDF | 2.4119.204.0 | A-2.4119.204.0 |
| SDF | 1141801 | A-1141801 | SDF | 16062841 | A-16062841 |
| SDF | 1397518 | A-1397518 | SDF | 2.4119.210.0 | A-2.4119.210.0 |
| SDF | 6212895 | A-6212895 | SDF | 2.4119.208.0 | A-2.4119.208.0 |
| SDF | 1139634 | A-1139634 | SDF | 2.4119.207.0 | A-2.4119.207.0 |
| SDF | 1141642 | A-1141642 | SDF | 0.017.4868.0 | A-.017.4868.0 |
| SDF | 6212896 | A-6212896 | SDF | 0.018.9690.0 | A-.018.9690.0 |
| SDF | 1139207 | A-1139207 | SDF | 16062842 | A-16062842 |
| SDF | 6204331 | A-6204331 | SDF | 16061769 | A-16061769 |
| SDF | 1139240 | A-1139240 | SDF | 36200413 | A-36200413 |
| SDF | 6204314 | A-6204314 | SDF | 3170529 | A-3170529 |
| SDF | 6204324 | A-6204324 | SDF | 33700746 | A-33700746 |
| SDF | 6212907 | A-6212907 | SDF | 3170537 | A-3170537 |
| SDF | 1139253 | A-1139253 | SDF | 3170537 | A-3170537 |
| SDF | 1139254 | A-1139254 | SDF | 4154525 | A-4154525 |
| SDF | 6212925 | A-6212925 | SDF | 9351.0176.00 | A-9351.0176.00 |
| SDF | 6212927 | A-6212927 | SDF | 0.018.9044.0 | A-.018.9044.0 |
| SDF | 6235567 | A-6235567 | SDF | 2.4119.213.0 | A-2.4119.213.0 |
| SDF | 6241910 | A-6241910 | SDF | T040H02 | A-T040H02 |
| SDF | 6301463 | A-6301463 | SDF | 1146033 | A-1146033 |
| SDF | 1139256 | A-1139256 | SDF | 16062885 | A-16062885 |
| SDF | 1139209 | A-1139209 | SDF | 16062737 | A-16062737 |
| SDF | 6212932 | A-6212932 | SDF | 16062737/10 | A-16062737/10 |
| SDF | 6212933 | A-6212933 | SDF | 16062737/30 | A-16062737/30 |
| SDF | 1139210 | A-1139210 | SDF | 16062737/20 | A-16062737/20 |
| SDF | 1141623 | A-1141623 | SDF | 16039033 | A-16039033 |
| SDF | 6212845 | A-6212845 | SDF | 16062738 | A-16062738 |
| SDF | 1139205 | A-1139205 | SDF | 0.017.7465.0 | A-.017.7465.0 |
| SDF | 1139206 | A-1139206 | SDF | 1141820 | A-1141820 |
| SDF | 6212855 | A-6212855 | SDF | 1145064 | A-1145064 |
| SDF | 6212839 | A-6212839 | SDF | 1141888 | A-1141888 |
| SDF | 6212840 | A-6212840 | SDF | 1145224 | A-1145224 |
| SDF | 1139213 | A-1139213 | SDF | 16031404 | A-16031404 |
| SDF | 6212842 | A-6212842 | SDF | 6215207 | A-6215207 |
| SDF | 6212843 | A-6212843 | SDF | 16062883 | A-16062883 |
| SDF | 1141637 | A-1141637 | SDF | 3651575 | A-3651575 |
| SDF | 6273876 | A-6273876 | SDF | 0.018.1907.0 | A-.018.1907.0 |
| SDF | 6215208 | A-6215208 | SDF | 16024474 | A-16024474 |
| SDF | 1141904 | A-1141904 | SDF | 16062265 | A-16062265 |
| SDF | 1145626 | A-1145626 | SDF | 0.018.1930.0 | A-.018.1930.0 |
| SDF | 1145726 | A-1145726 | SDF | 6259006 | A-6259006 |





SAME-DEUTZ-FAHR (SDF)

| OEM | OEM  Part No. | PIX  Part No. | OEM | OEM  Part No. | PIX  Part No. |
|-----|--|--|-----|--|--|
| SDF | 1145334 | A-1145334 | SDF | 1183380 | A-1183380 |
| SDF | 6215211 | A-6215211 | SDF | 1183558 | A-1183558 |
| SDF | 6204313 | A-6204313 | SDF | 1182607 | A-1182607 |
| SDF | 16062735 | A-16062735 | SDF | 1183391 | A-1183391 |
| SDF | 16026321 | A-16026321 | SDF | 1182312 | A-1182312 |
| SDF | 16055471 | A-16055471 | SDF | 1182360 | A-1182360 |
| SDF | 1182599 | A-1182599 | SDF | 1182367 | A-1182367 |
| SDF | 1148874 | A-1148874 | SDF | 1182728 | A-1182728 |
| SDF | 1179988 | A-1179988 | SDF | 1182729 | A-1182729 |
| SDF | 1179565 | A-1179565 | SDF | 1182830 | A-1182830 |
| SDF | 1179565 | A-1179565 | SDF | 1182831 | A-1182831 |
| SDF | 1179564 | A-1179564 | SDF | 1182832 | A-1182832 |
| SDF | 1179564 | A-1179564 | SDF | 1183144 | A-1183144 |
| SDF | 1180173 | A-1180173 | SDF | 1183145 | A-1183145 |
| SDF | 1180173 | A-1180173 | SDF | 1183146 | A-1183146 |
| SDF | 1180833 | A-1180833 | SDF | 1183147 | A-1183147 |
| SDF | 1182499 | A-1182499 | SDF | 1183148 | A-1183148 |
| SDF | 1178461 | A-1178461 | SDF | 1183149 | A-1183149 |
| SDF | 1178461 | A-1178461 | SDF | 1182310 | A-1182310 |
| SDF | 1179777 | A-1179777 | SDF | 1182365 | A-1182365 |
| SDF | 1182339 | A-1182339 | SDF | 1182726 | A-1182726 |
| SDF | 1154352 | A-1154352 | SDF | 1182727 | A-1182727 |
| SDF | 1180468 | A-1180468 | SDF | 1183150 | A-1183150 |
| SDF | 1154352 | A-1154352 | SDF | 1183151 | A-1183151 |
| SDF | 1179088 | A-1179088 | SDF | 1183152 | A-1183152 |
| SDF | 1183205 | A-1183205 | SDF | 1183559 | A-1183559 |
| SDF | 1168314 | A-1168314 | SDF | 1181730 | A-1181730 |
| SDF | 1178737 | A-1178737 | SDF | 1182740 | A-1182740 |
| SDF | 1179479 | A-1179479 | SDF | 1183153 | A-1183153 |
| SDF | 1180619 | A-1180619 | SDF | 1183377 | A-1183377 |
| SDF | 1182063 | A-1182063 | SDF | 1182347 | A-1182347 |
| SDF | 1180172 | A-1180172 | SDF | 1182369 | A-1182369 |
| SDF | 16062763 | A-16062763 | SDF | 1182449 | A-1182449 |
| SDF | 16062884 | A-16062884 | SDF | 1182730 | A-1182730 |
| SDF | 1180150 | A-1180150 | SDF | 1182731 | A-1182731 |
| SDF | 1154311 | A-1154311 | SDF | 1183154 | A-1183154 |
| SDF | 1178685 | A-1178685 | SDF | 1183155 | A-1183155 |
| SDF | 1180847 | A-1180847 | SDF | 1183156 | A-1183156 |
| SDF | 1145693 | A-1145693 | SDF | 1182471 | A-1182471 |
| SDF | 0.017.9350.0 | A-.017.9350.0 | SDF | 1182559 | A-1182559 |
| SDF | 2.4119.203.0 | A-2.4119.203.0 | SDF | 1183164 | A-1183164 |
| SDF | 2.4119.205.0 | A-2.4119.205.0 | SDF | 1182767 | A-1182767 |
| SDF | X221765 | A-X221765 | SDF | 1183165 | A-1183165 |
| SDF | 1181748 | A-1181748 | SDF | 1168311 | A-1168311 |
| SDF | 1182600 | A-1182600 | SDF | 1168313 | A-1168313 |
| SDF | 1183420 | A-1183420 | SDF | 1168316 | A-1168316 |
| SDF | 1181768 | A-1181768 | SDF | 1169889 | A-1169889 |



SAME-DEUTZ-FAHR (SDF)

| OEM | OEM  Part No. | PIX  Part No. | OEM | OEM  Part No. | PIX  Part No. |
|-----|--|--|-----|--|--|
| SDF | 1168318 | A-1168318 | SDF | 1145703 | A-1145703 |
| SDF | 1172391 | A-1172391 | SDF | 1136731 | A-1136731 |
| SDF | 1168322 | A-1168322 | SDF | 1145368 | A-1145368 |
| SDF | 1168328 | A-1168328 | SDF | 6215254 | A-6215254 |
| SDF | 1168330 | A-1168330 | SDF | 1145961 | A-1145961 |
| SDF | 1168334 | A-1168334 | SDF | 1145630 | A-1145630 |
| SDF | 1168333 | A-1168333 | SDF | 6215251 | A-6215251 |
| SDF | 1160050 | A-1160050 | SDF | 19971575 | A-1-99-71575 |
| SDF | 1116064 | A-1116064 | SDF | 1145465 | A-1145465 |
| SDF | 1116059 | A-1116059 | SDF | 19951995 | A-1-99-51995 |
| SDF | 1153065 | A-1153065 | SDF | 1145484 | A-1145484 |
| SDF | 1116061 | A-1116061 | SDF | 1145766 | A-1145766 |
| SDF | 1116078 | A-1116078 | SDF | 1145627 | A-1145627 |
| SDF | 1116087 | A-1116087 | SDF | 1183480 | A-1183480 |
| SDF | 1129779 | A-1129779 | SDF | 1182426 | A-1182426 |
| SDF | 1137509 | A-1137509 | SDF | 1182428 | A-1182428 |
| SDF | 1136717 | A-1136717 | SDF | 1183129 | A-1183129 |
| SDF | 1130742 | A-1130742 | SDF | 1183130 | A-1183130 |
| SDF | 1146013 | A-1146013 | SDF | 1183131 | A-1183131 |
| SDF | 1146045 | A-1146045 | SDF | 1182293 | A-1182293 |
| SDF | 1139067 | A-1139067 | SDF | 1182373 | A-1182373 |
| SDF | 1129780 | A-1129780 | SDF | 1182732 | A-1182732 |
| SDF | 1139068 | A-1139068 | SDF | 1182733 | A-1182733 |
| SDF | 1146027 | A-1146027 | SDF | 1183133 | A-1183133 |
| SDF | 1139248 | A-1139248 | SDF | 1183134 | A-1183134 |
| SDF | 1139250 | A-1139250 | SDF | 1183135 | A-1183135 |
| SDF | 1139251 | A-1139251 | SDF | 1183335 | A-1183335 |
| SDF | 1101674 | A-1101674 | SDF | 1183704 | A-1183704 |
| SDF | 1136724 | A-1136724 | SDF | 1182470 | A-1182470 |
| SDF | 1136747 | A-1136747 | SDF | 1182558 | A-1182558 |
| SDF | 1129970 | A-1129970 | SDF | 1183136 | A-1183136 |
| SDF | 6240407 | A-6240407 | SDF | 1183371 | A-1183371 |
| SDF | 11116150117 | A-11116150117.00 | SDF | 1182432 | A-1182432 |
| SDF | 1136729 | A-1136729 | SDF | 1182423 | A-1182423 |
| SDF | 4156783 | A-4156783 | SDF | 1182425 | A-1182425 |
| SDF | 4154836 | A-4154836 | SDF | 1183137 | A-1183137 |
| SDF | 1180449 | A-1180449 | SDF | 1183138 | A-1183138 |
| SDF | 4156387 | A-4156387 | SDF | 1183139 | A-1183139 |
| SDF | 4154401 | A-4154401 | SDF | 1182294 | A-1182294 |
| SDF | 1181254 | A-1181254 | SDF | 1148079 | A-1148079 |
| SDF | 6215228 | A-6215228 | SDF | 1183398 | A-1183398 |
| SDF | 19951021 | A-1-99-51021 | SDF | 1148492 | A-1148492 |
| SDF | 1145980 | A-1145980 | SDF | 1183361 | A-1183361 |
| SDF | 1145640 | A-1145640 | SDF | 1148512 | A-1148512 |
| SDF | 1146032 | A-1146032 | SDF | 1183364 | A-1183364 |
| SDF | 1145877 | A-1145877 | SDF | 1182718 | A-1182718 |
| SDF | 1145348 | A-1145348 | SDF | 1183362 | A-1183362 |



SAME-DEUTZ-FAHR (SDF)

| OEM | OEM  Part No. | PIX  Part No. | OEM | OEM  Part No. | PIX  Part No. |
|-----|--|--|-----|--|--|
| SDF | 1182651 | A-1182651 | SDF | 2235530 | A-2235530 |
| SDF | 1183363 | A-1183363 | SDF | 1179476 | A-1179476 |
| SDF | 1183367 | A-1183367 | SDF | 1179852 | A-1179852 |
| SDF | 1183073 | A-1183073 | SDF | 1179888 | A-1179888 |
| SDF | 1183173 | A-1183173 | SDF | 2235260 | A-2235260 |
| SDF | 1183366 | A-1183366 | SDF | 603450501300 | A-603450501300 |
| SDF | 1168307 | A-1168307 | SDF | 1179674 | A-1179674 |
| SDF | 1168308 | A-1168308 | SDF | 2235714 | A-2235714 |
| SDF | 1161860 | A-1161860 | SDF | 2235816 | A-2235816 |
| SDF | 1162716 | A-1162716 | SDF | 4232845 | A-4232845 |
| SDF | 1164848 | A-1164848 | SDF | 1183023 | A-1183023 |
| SDF | 1169885 | A-1169885 | SDF | 1183024 | A-1183024 |
| SDF | 1169886 | A-1169886 | SDF | 1179718 | A-1179718 |
| SDF | 1174612 | A-1174612 | SDF | 1179749 | A-1179749 |
| SDF | 1181184 | A-1181184 | SDF | 12270924 | A-12270924 |
| SDF | 1175882 | A-1175882 | SDF | 1180830 | A-1180830 |
| SDF | 1175929 | A-1175929 | SDF | 1176304 | A-1176304 |
| SDF | 1179978 | A-1179978 | SDF | 1179477 | A-1179477 |
| SDF | 1182053 | A-1182053 | SDF | 1179480 | A-1179480 |
| SDF | 1175928 | A-1175928 | SDF | 1175924 | A-1175924 |
| SDF | 1179996 | A-1179996 | SDF | 1179675 | A-1179675 |
| SDF | 1180195 | A-1180195 | SDF | 1180194 | A-1180194 |
| SDF | 1182056 | A-1182056 | SDF | 603450201400 | A-603450201400 |
| SDF | 2235253 | A-2235253 | SDF | 1179720 | A-1179720 |
| SDF | 12500311 | A-12500311 | SDF | 1179722 | A-1179722 |
| SDF | 603450201100 | A-603450201100 | SDF | 2235261 | A-2235261 |
| SDF | 1156921 | A-1156921 | SDF | 1175960 | A-1175960 |
| SDF | 1179461 | A-1179461 | SDF | 1182810 | A-1182810 |
| SDF | 1180027 | A-1180027 | SDF | 603450201450 | A-603450201450 |
| SDF | 1179566 | A-1179566 | SDF | 2235262 | A-2235262 |
| SDF | 2235257 | A-2235257 | SDF | 1175766 | A-1175766 |
| SDF | 1154347 | A-1154347 | SDF | 1179779 | A-1179779 |
| SDF | 1180846 | A-1180846 | SDF | 1179478 | A-1179478 |
| SDF | 1154348 | A-1154348 | SDF | 1179481 | A-1179481 |
| SDF | 1154350 | A-1154350 | SDF | 1179780 | A-1179780 |
| SDF | 1182184 | A-1182184 | SDF | 1179781 | A-1179781 |
| SDF | 603450501200 | A-603450501200 | SDF | 1181897 | A-1181897 |
| SDF | 1176331 | A-1176331 | SDF | 1179782 | A-1179782 |
| SDF | 1179475 | A-1179475 | SDF | 1181675 | A-1181675 |
| SDF | 603450501225 | A-603450501225 | SDF | 1180434 | A-1180434 |
| SDF | 60345051225 | A-60345051225 | SDF | 1179471 | A-1179471 |
| SDF | 1182066 | A-1182066 | SDF | 1180640 | A-1180640 |
| SDF | 2235259 | A-2235259 | SDF | 1182064 | A-1182064 |
| SDF | 1176178 | A-1176178 | SDF | 1179472 | A-1179472 |
| SDF | 1180831 | A-1180831 | SDF | 1179648 | A-1179648 |
| SDF | 1179747 | A-1179747 | SDF | 1182050 | A-1182050 |
| SDF | 1179750 | A-1179750 | SDF | 1180901 | A-1180901 |



SAME-DEUTZ-FAHR (SDF)

| OEM | OEM  Part No. | PIX  Part No. | OEM | OEM  Part No. | PIX  Part No. |
|-----|--|--|-----|--|--|
| SDF | 1180709 | A-1180709 | SDF | 1180350 | A-1180350 |
| SDF | 1182065 | A-1182065 | SDF | 603450211275 | A-603450211275 |
| SDF | 2235377 | A-2235377 | SDF | 1180904 | A-1180904 |
| SDF | 603450200900 | A-603450200900 | SDF | 1182068 | A-1182068 |
| SDF | 1179474 | A-1179474 | SDF | 1154358 | A-1154358 |
| SDF | 1182045 | A-1182045 | SDF | 1174283 | A-1174283 |
| SDF | 1175745 | A-1175745 | SDF | 1178739 | A-1178739 |
| SDF | 1182051 | A-1182051 | SDF | 1180436 | A-1180436 |
| SDF | 1182207 | A-1182207 | SDF | 1182057 | A-1182057 |
| SDF | 673224 | A-0673224 | SDF | 1175974 | A-1175974 |
| SDF | 1179650 | A-1179650 | SDF | 1180612 | A-1180612 |
| SDF | 1179830 | A-1179830 | SDF | 1182062 | A-1182062 |
| SDF | 1182067 | A-1182067 | SDF | 603451111350 | A-603451111350 |
| SDF | 1175933 | A-1175933 | SDF | 1154305 | A-1154305 |
| SDF | 1180467 | A-1180467 | SDF | 1182185 | A-1182185 |
| SDF | 1182060 | A-1182060 | SDF | 12500125 | A-12500125 |
| SDF | 1180849 | A-1180849 | SDF | 1154306 | A-1154306 |
| SDF | 1182061 | A-1182061 | SDF | 1179673 | A-1179673 |
| SDF | 603450211050 | A-603450211050 | SDF | 603450211400 | A-603450211400 |
| SDF | 1154353 | A-1154353 | SDF | 603451111400 | A-603451111400 |
| SDF | 1182046 | A-1182046 | SDF | 603451311400 | A-603451311400 |
| SDF | 1182505 | A-1182505 | SDF | 4123559 | A-4123559 |
| SDF | 2418962 | A-2418962 | SDF | 1175939 | A-1175939 |
| SDF | 603450211075 | A-603450211075 | SDF | 4147300 | A-4147300 |
| SDF | 1178736 | A-1178736 | SDF | 12500285 | A-12500285 |
| SDF | 1179890 | A-1179890 | SDF | 603450211425 | A-603450211425 |
| SDF | 1179891 | A-1179891 | SDF | 1154307 | A-1154307 |
| SDF | 1180182 | A-1180182 | SDF | 1180437 | A-1180437 |
| SDF | 1182052 | A-1182052 | SDF | 1154308 | A-1154308 |
| SDF | 1154354 | A-1154354 | SDF | 1154359 | A-1154359 |
| SDF | 1154355 | A-1154355 | SDF | 1180438 | A-1180438 |
| SDF | 1181076 | A-1181076 | SDF | 603451311500 | A-603451311500 |
| SDF | 1182055 | A-1182055 | SDF | 1151369 | A-1151369 |
| SDF | 1182542 | A-1182542 | SDF | 1154310 | A-1154310 |
| SDF | 1182054 | A-1182054 | SDF | 12272665 | A-12272665 |
| SDF | 1175555 | A-1175555 | SDF | 12500218 | A-12500218 |
| SDF | 1178738 | A-1178738 | SDF | 1174834 | A-1174834 |
| SDF | 1180552 | A-1180552 | SDF | 603451111550 | A-603451111550 |
| SDF | 1181587 | A-1181587 | SDF | 12500121 | A-12500121 |
| SDF | 1183403 | A-1183403 | SDF | 1154312 | A-1154312 |
| SDF | 1175719 | A-1175719 | SDF | 603451111700 | A-603451111700 |
| SDF | 1175968 | A-1175968 | SDF | 1151370 | A-1151370 |
| SDF | 1177873 | A-1177873 | SDF | 1179456 | A-1179456 |
| SDF | 1180435 | A-1180435 | SDF | 1179639 | A-1179639 |
| SDF | 1154304 | A-1154304 | SDF | 1154351 | A-1154351 |
| SDF | 1175969 | A-1175969 | SDF | 1183250 | A-1183250 |
| SDF | 1175970 | A-1175970 | SDF | 12270923 | A-12270923 |

SAME-DEUTZ-FAHR (SDF)

| OEM | OEM  Part No. | PIX  Part No. |
|-------|--|--|
| SDF | 1180464 | A-1180464 |
| SDF | 1180663 | A-1180663 |
| SDF | 1182059 | A-1182059 |
| SDF | 1183019 | A-1183019 |
| SDF | 603451111075 | A-603451111075 |
| SDF | 12500266 | A-12500266 |
| SDF | 603450211375 | A-603450211375 |
| SDF | 110464 | A-110464 |
| SDF | 1139227 | A-1139227 |
| SDF | 1139228 | A-1139228 |
| SDF | 1136734 | A-1136734 |
| SDF | 1139230 | A-1139230 |
| SDF | 1139231 | A-1139231 |
| SDF | 6212870 | A-6212870 |
| SDF | 1139232 | A-1139232 |
| SDF | 1145991 | A-1145991 |
| SDF | 1139224 | A-1139224 |
| SDF | 6212828 | A-6212828 |
| SDF | 1132421 | A-1132421 |
| SDF | 1141555 | A-1141555 |
| SDF | 1141556 | A-1141556 |
| SDF | 1129970 | A-1129970 |
| SDF | 1136747 | A-1136747 |
| SDF | 603451391622 | A-603451391622 |
| SDF | 6215191 | A-6215191 |
| SDF | 6215192 | A-6215192 |
| SDF | 6215193 | A-6215193 |
| SAMPO | 1472227 | A-1472227 |

SAMPO

| OEM | OEM  Part No. | PIX  Part No. |
|-------|--|--|
| SAMPO | 613116 | A-613116 |
| SAMPO | 613122 | A-613122 |
| SAMPO | 613124 | A-613124 |
| SAMPO | 613126 | A-613126 |
| SAMPO | 613128 | A-613128 |
| SAMPO | 614115 | A-614115 |
| SAMPO | 614125 | A-614125 |
| SAMPO | 614148 | A-614148 |
| SAMPO | 614152 | A-614152 |
| SAMPO | 614166 | A-614166 |
| SAMPO | 614212 | A-614212 |
| SAMPO | 614217 | A-614217 |
| SAMPO | 614222 | A-614222 |
| SAMPO | 614224 | A-614224 |
| SAMPO | 614226 | A-614226 |
| SAMPO | 614246 | A-614246 |
| SAMPO | 614260 | A-614260 |
| SAMPO | 615108 | A-615108 |
| SAMPO | 615129 | A-615129 |
| SAMPO | 615130 | A-615130 |
| SAMPO | 615133 | A-615133 |
| SAMPO | 0615135SA | A-615135SA |
| SAMPO | 615142 | A-615142 |
| SAMPO | 615150 | A-615150 |
| SAMPO | 615159 | A-615159 |
| SAMPO | 615161 | A-615161 |
| SAMPO | 615162 | A-615162 |
| SAMPO | 615163 | A-615163 |
| SAMPO | 615165 | A-615165 |
| SAMPO | 615167 | A-615167 |
| SAMPO | 615170 | A-615170 |
| SAMPO | 615173 | A-615173 |
| SAMPO | 615179 | A-615179 |
| SAMPO | 615189 | A-615189 |
| SAMPO | 619044 | A-619044 |
| SAMPO | 619054 | A-619054 |
| SAMPO | 619065 | A-619065 |
| SAMPO | 619071 | A-619071 |
| SAMPO | 619080 | A-619080 |
| SAMPO | 619081 | A-619081 |
| SAMPO | 619082 | A-619082 |
| SAMPO | 619083 | A-619083 |
| SAMPO | 619091 | A-619091 |
| SAMPO | 619092 | A-619092 |
| SAMPO | 619095 | A-619095 |
| SAMPO | 619096 | A-619096 |
| SAMPO | 619168 | A-619168 |



SAMPO



| OEM | OEM Part No. | PIX Part No. |
|-------|--------------|--------------|
| SAMPO | 619169 | A-619169 |
| SAMPO | 619170 | A-619170 |
| SAMPO | 619174 | A-619174 |
| SAMPO | 619175 | A-619175 |
| SAMPO | 619179 | A-619179 |
| SAMPO | 619181 | A-619181 |
| SAMPO | 619182 | A-619182 |
| SAMPO | 619185 | A-619185 |
| SAMPO | R634644 | A-R634644 |
| SAMPO | R634650A | A-R634650A |
| SAMPO | R634655 | A-R634655 |
| SAMPO | R644247A | A-R644247A |
| SAMPO | R652307A | A-R652307A |
| SAMPO | R680791 | A-R680791 |
| SAMPO | R680812B | A-R680812B |
| SAMPO | R694252A | A-R694252A |
| SAMPO | R694253 | A-R694253 |
| SAMPO | R694254 | A-R694254 |
| SAMPO | R694255A | A-R694255A |
| SAMPO | R694256 | A-R694256 |
| SAMPO | R694263 | A-R694263 |
| SAMPO | R694943 | A-R694943 |
| SAMPO | R696665 | A-R696665 |
| SAMPO | R698062 | A-R698062 |
| SAMPO | R698063 | A-R698063 |
| SAMPO | R700327 | A-R700327 |
| SAMPO | R700328 | A-R700328 |
| SAMPO | R701183 | A-R701183 |
| SAMPO | R706495 | A-R706495 |
| ZMAJ | 837223100 | A-837223100 |

ZMAJ



| OEM | OEM Part No. | PIX Part No. |
|------|--------------|--------------|
| ZMAJ | 69011671 | A-69-011671 |
| ZMAJ | 833341369 | A-833341369 |
| ZMAJ | 837171980 | A-837171980 |
| ZMAJ | 833342046 | A-833342046 |
| ZMAJ | 833362380 | A-833362380 |
| ZMAJ | 833362410 | A-833362410 |
| ZMAJ | 833683750 | A-833683750 |
| ZMAJ | 832321213 | A-832321213 |
| ZMAJ | 832321540 | A-832321540 |
| ZMAJ | 832321795 | A-832321795 |
| ZMAJ | 833551959 | A-833551959 |
| ZMAJ | 833553180 | A-833553180 |
| ZMAJ | 833353335 | A-833353335 |
| ZMAJ | 833553520 | A-833553520 |
| ZMAJ | 833553810 | A-833553810 |
| ZMAJ | 832451630 | A-832451630 |
| ZMAJ | 832451715 | A-832451715 |
| ZMAJ | 832451755 | A-832451755 |
| ZMAJ | 832451810 | A-832451810 |
| ZMAJ | 690107/1 | A-69-0107/1 |
| ZMAJ | 832453165 | A-0832453165 |
| ZMAJ | 832503190 | A-0832503190 |
| ZMAJ | 832602130 | A-0832602130 |
| ZMAJ | 720211 | A-72-0211 |
| ZMAJ | 7101556 | A-71-01556 |
| ZMAJ | 690104 | A-69-0104 |
| ZMAJ | 831225600 | A-0831225600 |
| ZMAJ | 832321795 | A-832321795 |
| ZMAJ | 833551959 | A-833551959 |
| ZMAJ | 833553180 | A-833553180 |
| ZMAJ | 833353335 | A-833353335 |
| ZMAJ | 833553520 | A-833553520 |
| ZMAJ | 833553810 | A-833553810 |
| ZMAJ | 832451630 | A-832451630 |
| ZMAJ | 832451715 | A-832451715 |
| ZMAJ | 832451755 | A-832451755 |
| ZMAJ | 832451810 | A-832451810 |
| ZMAJ | 690107/1 | A-69-0107/1 |
| ZMAJ | 832453165 | A-0832453165 |
| ZMAJ | 832503190 | A-0832503190 |
| ZMAJ | 832602130 | A-0832602130 |
| ZMAJ | 720211 | A-72-0211 |
| ZMAJ | 7101556 | A-71-01556 |
| ZMAJ | 690104 | A-69-0104 |
| ZMAJ | 831225600 | A-0831225600 |



AGCO

| OEM | OEM  Part No. | PIX  Part No. |
|------|--|--|
| AGCO | 789931M1 | A-789931M1 |
| AGCO | 4311315 | A-4311315 |
| AGCO | 340433154 | A-340433154 |
| AGCO | 433531 | A-433531 |
| AGCO | 435125 | A-435125 |
| AGCO | 340435155 | A-340435155 |
| AGCO | 340433197 | A-340433197 |
| AGCO | 340433198 | A-340433198 |
| AGCO | 789967M1 | A-789967M1 |
| AGCO | 344311230 | A-344311230 |
| AGCO | 340433045 | A-340433045 |
| AGCO | 87800127 | A-87800127 |
| AGCO | 432244 | A-432244 |
| AGCO | 433417 | A-433417 |
| AGCO | 433537 | A-433537 |
| AGCO | 71161595 | A-71161595 |
| AGCO | 71161596 | A-71161596 |
| AGCO | 71164350 | A-71164350 |
| AGCO | 71165927 | A-71165927 |
| AGCO | 71167409 | A-71167409 |
| AGCO | 71197999 | A-71197999 |
| AGCO | 71310380 | A-71310380 |
| AGCO | 71310381 | A-71310381 |
| AGCO | 71310382 | A-71310382 |
| AGCO | 71322834 | A-71322834 |
| AGCO | 71324690 | A-71324690 |
| AGCO | 71339886 | A-71339886 |
| AGCO | 71347560 | A-71347560 |
| AGCO | 71347561 | A-71347561 |
| AGCO | 71348999 | A-71348999 |
| AGCO | 71356409 | A-71356409 |
| AGCO | 71364922 | A-71364922 |
| AGCO | 226981M1 | A-226981M1 |
| AGCO | 1720255M1 | A-1720255M1 |
| AGCO | 1724154M1 | A-1724154M1 |
| AGCO | 265522M91 | A-265522M91 |
| AGCO | 402607M1 | A-402607M1 |
| AGCO | 833868M2 | A-833868M2 |
| AGCO | 833873M1 | A-833873M1 |
| AGCO | 843310M1 | A-843310M1 |
| AGCO | 71118003 | A-71118003 |
| AGCO | 71139962 | A-71139962 |
| AGCO | 71173472 | A-71173472 |
| AGCO | 71305994 | A-71305994 |
| AGCO | 71326830 | A-71326830 |
| AGCO | 71139966 | A-71139966 |
| AGCO | 71170690 | A-71170690 |



| OEM | OEM  Part No. | PIX  Part No. |
|------|--|--|
| AGCO | 71342142 | A-71342142 |
| AGCO | 71342143 | A-71342143 |
| AGCO | 526369 | A-526369 |
| AGCO | 855122 | A-855122 |
| AGCO | 1710292 | A-1710292 |
| AGCO | 71132108 | A-71132108 |
| AGCO | 71147547 | A-71147547 |
| AGCO | 71164177 | A-71164177 |
| AGCO | 71175575 | A-71175575 |
| AGCO | 71175989 | A-71175989 |
| AGCO | 71176492 | A-71176492 |
| AGCO | 71177537 | A-71177537 |
| AGCO | 71187728 | A-71187728 |
| AGCO | 71187779 | A-71187779 |
| AGCO | 71300867 | A-71300867 |
| AGCO | 71309150 | A-71309150 |
| AGCO | 71309685 | A-71309685 |
| AGCO | 71322828 | A-71322828 |
| AGCO | 71325150 | A-71325150 |
| AGCO | 71359598 | A-71359598 |
| AGCO | 71448483 | A-71448483 |
| AGCO | 700705430 | A-700705430 |
| AGCO | 700711852 | A-700711852 |
| AGCO | 1036940M1 | A-1036940M1 |
| AGCO | 71432802 | A-71432802 |
| AGCO | 842413M2 | A-842413M2 |
| AGCO | 41975300 | A-41975300 |
| AGCO | 509572M1 | A-509572M1 |
| AGCO | 531371M1 | A-531371M1 |
| AGCO | 621259M1 | A-621259M1 |
| AGCO | 832789M3 | A-832789M3 |
| AGCO | 833855M1 | A-833855M1 |
| AGCO | 833874M1 | A-833874M1 |
| AGCO | 3617180M91 | A-3617180M91 |
| AGCO | 71194500 | A-71194500 |
| AGCO | 71135618 | A-71135618 |
| AGCO | 71157414 | A-71157414 |
| AGCO | 71167114 | A-71167114 |
| AGCO | 71300996 | A-71300996 |
| AGCO | 700705773 | A-700705773 |
| AGCO | 621646M1 | A-621646M1 |
| AGCO | 834110M1 | A-834110M1 |
| AGCO | 834174M1 | A-834174M1 |
| AGCO | D41981200 | A-D41981200 |
| AGCO | 417974M1 | A-417974M1 |
| AGCO | 3614706M92 | A-3614706M92 |
| AGCO | 71336307 | A-71336307 |



AGCO

| OEM | OEM  Part No. | PIX  Part No. |
|------|--|--|
| AGCO | 1447778M91 | A-1447778M91 |
| AGCO | 1693746M1 | A-1693746M1 |
| AGCO | 3582952M1 | A-3582952M1 |
| AGCO | 3637306M91 | A-3637306M91 |
| AGCO | 72099473 | A-72099473 |
| AGCO | 71146659 | A-71146659 |
| AGCO | 855635 | A-855635 |
| AGCO | 905921M1 | A-905921M1 |
| AGCO | 71318378 | A-71318378 |
| AGCO | 71188155 | A-71188155 |
| AGCO | 82850751 | A-82850751 |
| AGCO | 855718 | A-855718 |
| AGCO | 70260149 | A-70260149 |
| AGCO | 70267630 | A-70267630 |
| AGCO | 70268485 | A-70268485 |
| AGCO | 70273193 | A-70273193 |
| AGCO | 71139963 | A-71139963 |
| AGCO | 71193749 | A-71193749 |
| AGCO | 71302482 | A-71302482 |
| AGCO | 71309140 | A-71309140 |
| AGCO | 71317254 | A-71317254 |
| AGCO | 71444986 | A-71444986 |
| AGCO | 72501439 | A-72501439 |
| AGCO | 3435748M1 | A-3435748M1 |
| AGCO | 515382M1 | A-515382M1 |
| AGCO | 1612892M91 | A-1612892M91 |
| AGCO | 1686616M91 | A-1686616M91 |
| AGCO | 1690692M1 | A-1690692M1 |
| AGCO | 2801859M1 | A-2801859M1 |
| AGCO | 3383044M91 | A-3383044M91 |
| AGCO | 3612115M1 | A-3612115M1 |
| AGCO | 517951M91 | A-517951M91 |
| AGCO | 518506M92 | A-518506M92 |
| AGCO | 1688988M1 | A-1688988M1 |
| AGCO | 1693745M1 | A-1693745M1 |
| AGCO | 3637597M1 | A-3637597M1 |
| AGCO | 515383M1 | A-515383M1 |
| AGCO | 433435 | A-433435 |
| AGCO | 434140 | A-434140 |
| AGCO | 4311316 | A-4311316 |
| AGCO | 418232M1 | A-418232M1 |
| AGCO | 890982M1 | A-890982M1 |
| AGCO | Cg350620001 | A-CG350620001 |
| AGCO | Sm1675342 | A-SM1675342 |
| AGCO | Sm1713549 | A-SM1713549 |
| AGCO | Sm1716854 | A-SM1716854 |
| AGCO | Sm1716959 | A-SM1716959 |

| OEM | OEM  Part No. | PIX  Part No. |
|------|--|--|
| AGCO | Sm1725557 | A-SM1725557 |
| AGCO | 1604401M1 | A-1604401M1 |
| AGCO | 410647M1 | A-410647M1 |
| AGCO | Cg350628130 | A-CG350628130 |
| AGCO | Cg350628140 | A-CG350628140 |
| AGCO | D41928800 | A-D41928800 |
| AGCO | D41934800 | A-D41934800 |
| AGCO | D41978600 | A-D41978600 |
| AGCO | 3170530M1 | A-3170530M1 |
| AGCO | 916801M2 | A-916801M2 |
| AGCO | D41990069 | A-D41990069 |
| AGCO | D41990053 | A-D41990053 |
| AGCO | 433440 | A-433440 |
| AGCO | 410617M1 | A-410617M1 |
| AGCO | D41998900 | A-D41998900 |
| AGCO | 320496M3 | A-320496M3 |
| AGCO | 623537M1 | A-623537M1 |
| AGCO | 1720205M3 | A-1720205M3 |
| AGCO | 1730782M1 | A-1730782M1 |
| AGCO | 629004M1 | A-629004M1 |
| AGCO | 826960M1 | A-826960M1 |
| AGCO | 1687610M91 | A-1687610M91 |
| AGCO | 962666M1 | A-962666M1 |
| AGCO | X696640500000 | A-X696640500000 |
| AGCO | 3619084M91 | A-3619084M91 |
| AGCO | 3779379M91 | A-3779379M91 |
| AGCO | 3780603M91 | A-3780603M91 |
| AGCO | 3780605M91 | A-3780605M91 |
| AGCO | 3780606M91 | A-3780606M91 |
| AGCO | 3780608M91 | A-3780608M91 |
| AGCO | 3780616M91 | A-3780616M91 |
| AGCO | 4274693M91 | A-4274693M91 |
| AGCO | 1447784M91 | A-1447784M91 |
| AGCO | 3381364M91 | A-3381364M91 |
| AGCO | 3786922M91 | A-3786922M91 |
| AGCO | 3808704M1 | A-3808704M1 |
| AGCO | 4274692M91 | A-4274692M91 |
| AGCO | 5015577M1 | A-5015577M1 |
| AGCO | 5016260M1 | A-5016260M1 |
| AGCO | 828729M1 | A-828729M1 |
| AGCO | D41990014 | A-D41990014 |
| AGCO | D41991100 | A-D41991100 |
| AGCO | Sm1718602 | A-SM1718602 |
| AGCO | V32889500 | A-V32889500 |
| AGCO | V33099800 | A-V33099800 |
| AGCO | V33279300 | A-V33279300 |
| AGCO | V33279600 | A-V33279600 |



AGCO

| OEM | OEM  Part No. | PIX  Part No. |
|------|--|--|
| AGCO | V33764400 | A-V33764400 |
| AGCO | V35380300 | A-V35380300 |
| AGCO | V35615000 | A-V35615000 |
| AGCO | V36763300 | A-V36763300 |
| AGCO | V684121275 | A-V684121275 |
| AGCO | V684121400 | A-V684121400 |
| AGCO | D41929100 | A-D41929100 |
| AGCO | 619317M2 | A-619317M2 |
| AGCO | D41983800 | A-D41983800 |
| AGCO | D41995700 | A-D41995700 |
| AGCO | D41980600 | A-D41980600 |
| AGCO | 412333M1 | A-412333M1 |
| AGCO | D41980000 | A-D41980000 |
| AGCO | D41980700 | A-D41980700 |
| AGCO | D41980100 | A-D41980100 |
| AGCO | D41994300 | A-D41994300 |
| AGCO | V685121370 | A-V685121370 |
| AGCO | V685121610 | A-V685121610 |
| AGCO | V685121905 | A-V685121905 |
| AGCO | 3789028M1 | A-3789028M1 |
| AGCO | 4271806M1 | A-4271806M1 |
| AGCO | 4273270M1 | A-4273270M1 |
| AGCO | 4275784M1 | A-4275784M1 |
| AGCO | 4282444M1 | A-4282444M1 |
| AGCO | V685061755 | A-V685061755 |
| AGCO | 506066D1 | A-506066D1 |
| AGCO | F716200040020 | A-F716200040020 |
| AGCO | V685081660 | A-V685081660 |
| AGCO | X696616800000 | A-X696616800000 |
| AGCO | 1688216M91 | A-1688216M91 |
| AGCO | 3371800M2 | A-3371800M2 |
| AGCO | 3637598M91 | A-3637598M91 |
| AGCO | 3648900M1 | A-3648900M1 |
| AGCO | 3777681M91 | A-3777681M91 |
| AGCO | 3780604M91 | A-3780604M91 |
| AGCO | 3787373M2 | A-3787373M2 |
| AGCO | 4272496M1 | A-4272496M1 |
| AGCO | 4273187M1 | A-4273187M1 |
| AGCO | 4273188M1 | A-4273188M1 |
| AGCO | 4274241M1 | A-4274241M1 |
| AGCO | 4275520M1 | A-4275520M1 |
| AGCO | 4276808M1 | A-4276808M1 |
| AGCO | 4278354M91 | A-4278354M91 |
| AGCO | X696623800000 | A-X696623800000 |
| AGCO | 684101050 | A-684101050 |
| AGCO | 684101225 | A-684101225 |
| AGCO | 684121200 | A-684121200 |



| OEM | OEM  Part No. | PIX  Part No. |
|------|--|--|
| AGCO | 684121275 | A-684121275 |
| AGCO | 684121375 | A-684121375 |
| AGCO | 684121400 | A-684121400 |
| AGCO | 685061675 | A-685061675 |
| AGCO | 685061725 | A-685061725 |
| AGCO | 685061755 | A-685061755 |
| AGCO | 685081660 | A-685081660 |
| AGCO | 685102194 | A-685102194 |
| AGCO | 685121370 | A-685121370 |
| AGCO | 685121530 | A-685121530 |
| AGCO | 685121610 | A-685121610 |
| AGCO | 685121765 | A-685121765 |
| AGCO | 685121905 | A-685121905 |
| AGCO | 685122140 | A-685122140 |
| AGCO | 685121585 | A-685121585 |
| AGCO | 783539M1 | A-783539M1 |
| AGCO | 072728T1 | A-072728T1 |
| AGCO | V684120918 | A-V684120918 |
| AGCO | 782835M1 | A-782835M1 |
| AGCO | 1616715M1 | A-1616715M1 |
| AGCO | 6907 | A-0006907 |
| AGCO | 621261M1 | A-621261M1 |
| AGCO | 905980M1 | A-905980M1 |
| AGCO | 619327M1 | A-619327M1 |
| AGCO | 6215259 | A-6215259 |
| AGCO | 55574 | A-0000055574 |
| AGCO | 311730870 | A-31-1730870 |
| AGCO | 412237M1 | A-412237M1 |
| AGCO | 1616714M1 | A-1616714M1 |
| AGCO | 401110M1 | A-401110M1 |
| AGCO | 621321M2 | A-621321M2 |
| AGCO | 41978300 | A-41978300 |
| AGCO | X696615002000 | A-X696615002000 |
| AGCO | X696615200000 | A-X696615200000 |
| AGCO | X696613501000 | A-X696613501000 |
| AGCO | X696615601000 | A-X696615601000 |
| AGCO | X696612200000 | A-X696612200000 |
| AGCO | X696612600000 | A-X696612600000 |
| AGCO | X696616201000 | A-X696616201000 |
| AGCO | X696612000000 | A-X696612000000 |
| AGCO | X696616702000 | A-X696616702000 |
| AGCO | X696614802000 | A-X696614802000 |
| AGCO | X696615704000 | A-X696615704000 |
| AGCO | X696616600000 | A-X696616600000 |
| AGCO | X696617800000 | A-X696617800000 |
| AGCO | X696623600000 | A-X696623600000 |
| AGCO | X696624300000 | A-X696624300000 |



AGCO

| OEM | OEM  Part No. | PIX  Part No. |
|------|--|--|
| AGCO | X696624200000 | A-X696624200000 |
| AGCO | X696624500000 | A-X696624500000 |
| AGCO | X696624800000 | A-X696624800000 |
| AGCO | X696642000000 | A-X696642000000 |
| AGCO | X696622700000 | A-X696622700000 |
| AGCO | X696623000000 | A-X696623000000 |
| AGCO | X696623200000 | A-X696623200000 |
| AGCO | 71324294 | A-71324294 |
| AGCO | 856591 | A-856591 |
| AGCO | H567947R2 | A-H567947R2 |
| AGCO | X697174000000 | A-X697174000000 |
| AGCO | 916201040200 | A-916201040200 |
| AGCO | 1976291 | A-1976291 |
| AGCO | D41986900 | A-D41986900 |
| AGCO | H558141R1 | A-H558141R1 |
| AGCO | 068918T1 | A-068918T1 |
| AGCO | X696989501000 | A-X696989501000 |
| AGCO | D419943400 | A-D419943400 |
| AGCO | 833874M2 | A-833874M2 |
| AGCO | 435127 | A-435127 |
| AGCO | 833865M2 | A-833865M2 |
| AGCO | 41990061 | A-41990061 |
| AGCO | V685081730 | A-V685081730 |
| AGCO | 524200040160 | A-524200040160 |
| AGCO | 511275M1 | A-511275M1 |
| AGCO | 433128 | A-433128 |
| AGCO | Cg350614260 | A-CG350614260 |
| AGCO | Cg350615010 | A-CG350615010 |
| AGCO | 340433166 | A-340433166 |
| AGCO | 3021251M1 | A-3021251M1 |
| AGCO | 523735M1 | A-523735M1 |
| AGCO | Cg350620010 | A-CG350620010 |
| AGCO | Cg350620100 | A-CG350620100 |
| AGCO | Sm1720402 | A-SM1720402 |
| AGCO | Cg350657000 | A-CG350657000 |
| AGCO | D41987000 | A-D41987000 |
| AGCO | 3808705M1 | A-3808705M1 |
| AGCO | F100002235531 | A-F100002235531 |
| AGCO | F100002235175 | A-F100002235175 |
| AGCO | 3809174M1 | A-3809174M1 |
| AGCO | 3809175M1 | A-3809175M1 |
| AGCO | 3815257M1 | A-3815257M1 |
| AGCO | 3817582M1 | A-3817582M1 |
| AGCO | 3815255M2 | A-3815255M2 |
| AGCO | 1851749M1 | A-1851749M1 |
| AGCO | V684121525 | A-V684121525 |
| AGCO | 3412285M2 | A-3412285M2 |



| OEM | OEM  Part No. | PIX  Part No. |
|------|--|--|
| AGCO | 3041017M1 | A-3041017M1 |
| AGCO | F117200010010 | A-F117200010010 |
| AGCO | V33764500 | A-V33764500 |
| AGCO | 321034M1 | A-321034M1 |
| AGCO | 402603M1 | A-402603M1 |
| AGCO | 916854M1 | A-916854M1 |
| AGCO | 405928M1 | A-405928M1 |
| AGCO | 233950M1 | A-233950M1 |
| AGCO | 903594M2 | A-903594M2 |
| AGCO | 1720674M2 | A-1720674M2 |
| AGCO | 340433257 | A-340433257 |
| AGCO | D41926400 | A-D41926400 |
| AGCO | 228999M1 | A-228999M1 |
| AGCO | 320593M2 | A-320593M2 |
| AGCO | D41955400 | A-D41955400 |
| AGCO | 3170531M1 | A-3170531M1 |
| AGCO | 3371438M1 | A-3371438M1 |
| AGCO | H143874C2 | A-H143874C2 |
| AGCO | Sm1721532 | A-SM1721532 |
| AGCO | Sm1719911 | A-SM1719911 |
| AGCO | Cg350614230 | A-CG350614230 |
| AGCO | Cg350620110 | A-CG350620110 |
| AGCO | Sm1719746 | A-SM1719746 |
| AGCO | 427806M1 | A-427806M1 |
| AGCO | 4277220M1 | A-4277220M1 |
| AGCO | 4273296M1 | A-4273296M1 |
| AGCO | 1603701M1 | A-1603701M1 |
| AGCO | 3098211M2 | A-3098211M2 |
| AGCO | 621262M1 | A-621262M1 |
| AGCO | 785810M1 | A-785810M1 |
| AGCO | 789853M1 | A-789853M1 |
| AGCO | 789930M1 | A-789930M1 |
| AGCO | 833858M5 | A-833858M5 |
| AGCO | 844077M1 | A-844077M1 |
| AGCO | 3617178M91 | A-3617178M91 |
| AGCO | 711148120 | A-711148120 |
| AGCO | 002215U1 | A-002215U1 |
| AGCO | E38713 | A-E38713 |
| AGCO | 3049010M91 | A-3049010M91 |
| AGCO | 228722M1 | A-228722M1 |
| AGCO | 411218M1 | A-411218M1 |
| AGCO | 905982M1 | A-905982M1 |
| AGCO | D41980900 | A-D41980900 |
| AGCO | 3373171M2 | A-3373171M2 |
| AGCO | V35354900 | A-V35354900 |
| AGCO | V33763300 | A-V33763300 |
| AGCO | 832538M1 | A-832538M1 |



AGCO

| OEM | OEM  Part No. | PIX  Part No. |
|------|--|--|
| AGCO | 623537M1 | A-623537M1 |
| AGCO | 1669923M1 | A-1669923M1 |
| AGCO | 1809095M2 | A-1809095M2 |
| AGCO | 832490M1 | A-832490M1 |
| AGCO | 71448482 | A-71448482 |
| AGCO | 513833M1 | A-513833M1 |
| AGCO | 513133M1 | A-513133M1 |
| AGCO | 3040949M1 | A-3040949M1 |
| AGCO | 529900M91 | A-529900M91 |
| AGCO | 71448442 | A-71448442 |
| AGCO | 500685D1 | A-500685D1 |
| AGCO | 410959M1 | A-410959M1 |
| AGCO | X696624100000 | A-X696624100000 |
| AGCO | 517344M2 | A-517344M2 |
| AGCO | 3787792M1 | A-3787792M1 |
| AGCO | 186976M1 | A-186976M1 |
| AGCO | 517456M1 | A-517456M1 |
| AGCO | 843198M1 | A-843198M1 |
| AGCO | 87583785 | A-87583785 |
| AGCO | 4275545M3 | A-4275545M3 |
| AGCO | 344311322 | A-344311322 |
| AGCO | X697173600000 | A-X697173600000 |
| AGCO | X696622900000 | A-X696622900000 |
| AGCO | X696623300000 | A-X696623300000 |
| AGCO | X696623400000 | A-X696623400000 |
| AGCO | 71382504 | A-71382504 |
| AGCO | 71140808 | A-71140808 |
| AGCO | 71135970 | A-71135970 |
| AGCO | 71141744 | A-71141744 |
| AGCO | 71170191 | A-71170191 |
| AGCO | 71125976 | A-71125976 |
| AGCO | 71134654 | A-71134654 |
| AGCO | 71139964 | A-71139964 |
| AGCO | 71125978 | A-71125978 |
| AGCO | 111954W1 | A-111954W1 |
| AGCO | 966427M1 | A-966427M1 |
| AGCO | 038355T1 | A-038355T1 |
| AGCO | 274339M91 | A-274339M91 |
| AGCO | 038357T1 | A-038357T1 |
| AGCO | 240447M3 | A-240447M3 |
| AGCO | 3590943M1 | A-3590943M1 |
| AGCO | 238887M2 | A-238887M2 |
| AGCO | 1483880M1 | A-1483880M1 |
| AGCO | 1483881M1 | A-1483881M1 |
| AGCO | 857219 | A-857219 |
| AGCO | 3316647M1 | A-3316647M1 |
| AGCO | 855007 | A-855007 |



| OEM | OEM  Part No. | PIX  Part No. |
|------|--|--|
| AGCO | 3175109M1 | A-3175109M1 |
| AGCO | 3175160M1 | A-3175160M1 |
| AGCO | 230356M4 | A-230356M4 |
| AGCO | 71146271 | A-71146271 |
| AGCO | 7855810 | A-7855810 |
| AGCO | 71380485 | A-71380485 |
| AGCO | 312449520 | A-31-2449520 |
| AGCO | 059105T1 | A-059105T1 |
| AGCO | 71348989 | A-71348989 |
| AGCO | 833856M1 | A-833856M1 |
| AGCO | 834061M1 | A-834061M1 |
| AGCO | 273837M91 | A-273837M91 |
| AGCO | 521110M1 | A-521110M1 |
| AGCO | 487802M2 | A-487802M2 |
| AGCO | 524413M92 | A-524413M92 |
| AGCO | 3815256M1 | A-3815256M1 |
| AGCO | 3145238M1 | A-3145238M1 |
| AGCO | 1612891M91 | A-1612891M91 |
| AGCO | 3612930M1 | A-3612930M1 |
| AGCO | 064441T1 | A-064441T1 |
| AGCO | 6200432M1 | A-6200432M1 |
| AGCO | 059106T1 | A-059106T1 |
| AGCO | 3226971M2 | A-3226971M2 |
| AGCO | 41982300 | A-41982300 |
| AGCO | X697171901000 | A-X697171901000 |
| AGCO | X697171900000 | A-X697171900000 |
| AGCO | X697172100000 | A-X697172100000 |
| AGCO | 344311121 | A-344311121 |
| AGCO | 344311124 | A-344311124 |
| AGCO | 344311131 | A-344311131 |
| AGCO | X697170100000 | A-X697170100000 |
| AGCO | 41990045 | A-41990045 |
| AGCO | 41990062 | A-41990062 |
| AGCO | 4276375M1 | A-4276375M1 |
| AGCO | 41990060 | A-41990060 |
| AGCO | 3810420M1 | A-3810420M1 |
| AGCO | 121282 | A-121282 |
| AGCO | 124976 | A-124976 |
| AGCO | 122297 | A-122297 |
| AGCO | 122299 | A-122299 |
| AGCO | 122649 | A-122649 |
| AGCO | 122651 | A-122651 |
| AGCO | 122652 | A-122652 |
| AGCO | 122764 | A-122764 |
| AGCO | 122076 | A-122076 |
| AGCO | X696.614.700.000 | A-X696.614.700.000 |
| AGCO | 1630361M1 | A-1630361M1 |



AGCO

| OEM | OEM  Part No. | PIX  Part No. |
|------|--|--|
| AGCO | X696.615.408.000 | A-X696.615.408.000 |
| AGCO | X696.615.600.000 | A-X696.615.600.000 |
| AGCO | X696.610.600.000 | A-X696.610.600.000 |
| AGCO | X696.612.313.000 | A-X696.612.313.000 |
| AGCO | X696.612.500.000 | A-X696.612.500.000 |
| AGCO | X696.611.312.000 | A-X696.611.312.000 |
| AGCO | X696.613.308.000 | A-X696.613.308.000 |
| AGCO | X696.613.600.000 | A-X696.613.600.000 |
| AGCO | 41900000 | A-41900000 |
| AGCO | 624728M1 | A-624728M1 |
| AGCO | 1700120M1 | A-1700120M1 |
| AGCO | X696.619.413.000 | A-X696.619.413.000 |
| AGCO | 1876670M1 | A-1876670M1 |
| AGCO | 906424M1 | A-906424M1 |
| AGCO | 1614629M91 | A-1614629M91 |
| AGCO | 1730034M91 | A-1730034M91 |
| AGCO | 1730033M91 | A-1730033M91 |
| AGCO | X696.618.200.000 | A-X696.618.200.000 |
| AGCO | 511277M3 | A-511277M3 |
| AGCO | 41904900 | A-41904900 |
| AGCO | 41905600 | A-41905600 |
| AGCO | 117029010800 | A-117029010800 |
| AGCO | 3538921M1 | A-3538921M1 |
| AGCO | 84416M1 | A-84416M1 |
| AGCO | 41907500 | A-41907500 |
| AGCO | 3021313M3 | A-3021313M3 |
| AGCO | 41907800 | A-41907800 |
| AGCO | 1718508M91 | A-1718508M91 |
| AGCO | 3021192M1 | A-3021192M1 |
| AGCO | 530756M1 | A-530756M1 |
| AGCO | 41916800 | A-41916800 |
| AGCO | X696.622.000.000 | A-X696.622.000.000 |
| AGCO | 41902600 | A-41902600 |
| AGCO | 340433109 | A-340433109 |
| AGCO | 1617332M1 | A-1617332M1 |
| AGCO | X696.519.400.000 | A-X696.519.400.000 |
| AGCO | 41903000 | A-41903000 |
| AGCO | 41903400 | A-41903400 |
| AGCO | 514806M1 | A-514806M1 |
| AGCO | 340433119 | A-340433119 |
| AGCO | 523733M1 | A-523733M1 |
| AGCO | 530669M1 | A-530669M1 |
| AGCO | 058147P1 | A-058147P1 |
| AGCO | 518125M2 | A-518125M2 |
| AGCO | 669452M91 | A-669452M91 |
| AGCO | 41962600 | A-41962600 |
| AGCO | 1810382M91 | A-1810382M91 |



| OEM | OEM  Part No. | PIX  Part No. |
|------|--|--|
| AGCO | 605638M91 | A-605638M91 |
| AGCO | 1810543M91 | A-1810543M91 |
| AGCO | 403041M1 | A-403041M1 |
| AGCO | X696.633.800.000 | A-X696.633.800.000 |
| AGCO | 340433238 | A-340433238 |
| AGCO | 402604M1 | A-402604M1 |
| AGCO | 41924700 | A-41924700 |
| AGCO | 41925200 | A-41925200 |
| AGCO | 340433240 | A-340433240 |
| AGCO | 340433242 | A-340433242 |
| AGCO | 41924900 | A-41924900 |
| AGCO | 324872M1 | A-324872M1 |
| AGCO | X696.635.500.000 | A-X696.635.500.000 |
| AGCO | 417468M1 | A-417468M1 |
| AGCO | 584850M1 | A-584850M1 |
| AGCO | 604964M1 | A-604964M1 |
| AGCO | 41926100 | A-41926100 |
| AGCO | 340433251 | A-340433251 |
| AGCO | 7855356 | A-0007855356 |
| AGCO | 41926300 | A-41926300 |
| AGCO | 412074M1 | A-412074M1 |
| AGCO | 855650 | A-855650 |
| AGCO | 41926500 | A-41926500 |
| AGCO | 41926600 | A-41926600 |
| AGCO | 41964500 | A-41964500 |
| AGCO | 41964400 | A-41964400 |
| AGCO | 26733247 | A-26733247 |
| AGCO | 41963800 | A-41963800 |
| AGCO | 320596M1 | A-320596M1 |
| AGCO | 41928400 | A-41928400 |
| AGCO | 41928100 | A-41928100 |
| AGCO | 6273869M1 | A-6273869M1 |
| AGCO | 41929400 | A-41929400 |
| AGCO | 41930300 | A-41930300 |
| AGCO | 41930600 | A-41930600 |
| AGCO | 402605M1 | A-402605M1 |
| AGCO | 26733596 | A-26733596 |
| AGCO | 3101337M1 | A-3101337M1 |
| AGCO | 41965100 | A-41965100 |
| AGCO | 403071M1 | A-403071M1 |
| AGCO | 41931600 | A-41931600 |
| AGCO | 526370 | A-526370 |
| AGCO | 41931100 | A-41931100 |
| AGCO | 41932600 | A-41932600 |
| AGCO | 41932800 | A-41932800 |
| AGCO | 320623M2 | A-320623M2 |
| AGCO | 41933400 | A-41933400 |



AGCO

| OEM | OEM  Part No. | PIX  Part No. |
|------|--|--|
| AGCO | 41933900 | A-41933900 |
| AGCO | 26733578 | A-26733578 |
| AGCO | 761757 | A-761757 |
| AGCO | 527976 | A-527976 |
| AGCO | 41966500 | A-41966500 |
| AGCO | 41934900 | A-41934900 |
| AGCO | 41936300 | A-41936300 |
| AGCO | 41935500 | A-41935500 |
| AGCO | 41935700 | A-41935700 |
| AGCO | 832882M1 | A-832882M1 |
| AGCO | 41966900 | A-41966900 |
| AGCO | 26733588 | A-26733588 |
| AGCO | 407692M1 | A-407692M1 |
| AGCO | 41937600 | A-41937600 |
| AGCO | 6211078M1 | A-6211078M1 |
| AGCO | 41936800 | A-41936800 |
| AGCO | 41936500 | A-41936500 |
| AGCO | 41937800 | A-41937800 |
| AGCO | 41937300 | A-41937300 |
| AGCO | 26733248 | A-26733248 |
| AGCO | 3371692M1 | A-3371692M1 |
| AGCO | 41938000 | A-41938000 |
| AGCO | 6209375M1 | A-6209375M1 |
| AGCO | 41941900 | A-41941900 |
| AGCO | 41938900 | A-41938900 |
| AGCO | 41939300 | A-41939300 |
| AGCO | 41940900 | A-41940900 |
| AGCO | 41941100 | A-41941100 |
| AGCO | 3465729M1 | A-3465729M1 |
| AGCO | 41943600 | A-41943600 |
| AGCO | 1715558M91 | A-1715558M91 |
| AGCO | 41922200 | A-41922200 |
| AGCO | 623098M1 | A-623098M1 |
| AGCO | 1641945M1 | A-1641945M1 |
| AGCO | 641696M1 | A-641696M1 |
| AGCO | 41962000 | A-41962000 |
| AGCO | 636208M1 | A-636208M1 |
| AGCO | 636276M1 | A-636276M1 |
| AGCO | 328656M1 | A-328656M1 |
| AGCO | 1810378M91 | A-1810378M91 |
| AGCO | 619595M1 | A-619595M1 |
| AGCO | 782850M2 | A-782850M2 |
| AGCO | 322768M1 | A-322768M1 |
| AGCO | 320595M2 | A-320595M2 |
| AGCO | 41995100 | A-41995100 |
| AGCO | 418192M1 | A-418192M1 |
| AGCO | 41951700 | A-41951700 |

| OEM | OEM  Part No. | PIX  Part No. |
|------|--|--|
| AGCO | 410958M1 | A-410958M1 |
| AGCO | 410957M1 | A-410957M1 |
| AGCO | 604735M1 | A-604735M1 |
| AGCO | 412399M1 | A-412399M1 |
| AGCO | 6239971M1 | A-6239971M1 |
| AGCO | 6210650M1 | A-6210650M1 |
| AGCO | 3049776M1 | A-3049776M1 |
| AGCO | 41981900 | A-41981900 |
| AGCO | 901855M1 | A-901855M1 |
| AGCO | 56325 | A-56325 |
| AGCO | 340433476 | A-340433476 |
| AGCO | 916799M1 | A-916799M1 |
| AGCO | 6203660M1 | A-6203660M1 |
| AGCO | 1722835M1 | A-1722835M1 |
| AGCO | 201108520 | A-201108520 |
| AGCO | 6200242M1 | A-6200242M1 |
| AGCO | 41953700 | A-41953700 |
| AGCO | 41953300 | A-41953300 |
| AGCO | 41987100 | A-41987100 |
| AGCO | 41983300 | A-41983300 |
| AGCO | 41982000 | A-41982000 |
| AGCO | 41950000 | A-41950000 |
| AGCO | 856641 | A-856641 |
| AGCO | 787237M1 | A-787237M1 |
| AGCO | 195672M1 | A-195672M1 |
| AGCO | 200432M1 | A-200432M1 |
| AGCO | 41983900 | A-41983900 |
| AGCO | 402606M1 | A-402606M1 |
| AGCO | 784789M2 | A-784789M2 |
| AGCO | 41954100 | A-41954100 |
| AGCO | 856401 | A-856401 |
| AGCO | 41985900 | A-41985900 |
| AGCO | 7855331 | A-7855331 |
| AGCO | 3050742M1 | A-3050742M1 |
| AGCO | 053928T1 | A-053928T1 |
| AGCO | 41957600 | A-41957600 |
| AGCO | 410919M1 | A-410919M1 |
| AGCO | 41954300 | A-41954300 |
| AGCO | 412236M1 | A-412236M1 |
| AGCO | 41982600 | A-41982600 |
| AGCO | 41957500 | A-41957500 |
| AGCO | 1720488M1 | A-1720488M1 |
| AGCO | 1483884M1 | A-1483884M1 |
| AGCO | 432433 | A-432433 |
| AGCO | 41954800 | A-41954800 |
| AGCO | 41986800 | A-41986800 |
| AGCO | 41985700 | A-41985700 |

AGCO

| OEM | OEM  Part No. | PIX  Part No. |
|------|--|--|
| AGCO | 41950200 | A-41950200 |
| AGCO | 700714423 | A-700714423 |
| AGCO | 6212790M1 | A-6212790M1 |
| AGCO | 41955900 | A-41955900 |
| AGCO | 41957800 | A-41957800 |
| AGCO | 1731015M1 | A-1731015M1 |
| AGCO | 41955500 | A-41955500 |
| AGCO | 41950300 | A-41950300 |
| AGCO | 6203678M1 | A-6203678M1 |
| AGCO | 41984900 | A-41984900 |
| AGCO | 1731023M1 | A-1731023M1 |
| AGCO | 41955400 | A-41955400 |
| AGCO | 6211250M1 | A-6211250M1 |
| AGCO | 6216726M1 | A-6216726M1 |
| AGCO | 433442 | A-433442 |
| AGCO | 41955800 | A-41955800 |
| AGCO | 1615962M1 | A-1615962M1 |
| AGCO | 28284841 | A-28284841 |
| AGCO | 916800M2 | A-916800M2 |
| AGCO | 41956500 | A-41956500 |
| AGCO | 1628951M1 | A-1628951M1 |
| AGCO | 1730687M1 | A-1730687M1 |
| AGCO | 26732833 | A-26732833 |
| AGCO | 843324M1 | A-843324M1 |
| AGCO | 41986500 | A-41986500 |
| AGCO | 41983200 | A-41983200 |
| AGCO | 1730781M1 | A-1730781M1 |
| AGCO | 855791 | A-855791 |
| AGCO | 3173304M1 | A-3173304M1 |
| AGCO | 3172001M1 | A-3172001M1 |
| AGCO | 406681M1 | A-406681M1 |
| AGCO | 41985400 | A-41985400 |
| AGCO | 1730976M1 | A-1730976M1 |
| AGCO | 41987600 | A-41987600 |
| AGCO | 41958500 | A-41958500 |
| AGCO | 41958600 | A-41958600 |
| AGCO | 41987400 | A-41987400 |
| AGCO | 406562M1 | A-406562M1 |
| AGCO | 1730366M1 | A-1730366M1 |
| AGCO | 41987500 | A-41987500 |
| AGCO | 417972M1 | A-417972M1 |
| AGCO | 41984300 | A-41984300 |
| AGCO | 41988900 | A-41988900 |
| AGCO | 41988600 | A-41988600 |
| AGCO | 41988700 | A-41988700 |
| AGCO | 41989800 | A-41989800 |
| AGCO | 41989000 | A-41989000 |

| OEM | OEM  Part No. | PIX  Part No. |
|------|--|--|
| AGCO | 41992700 | A-41992700 |
| AGCO | 41990037 | A-41990037 |
| AGCO | 41989100 | A-41989100 |
| AGCO | 41992400 | A-41992400 |
| AGCO | 41998900 | A-41998900 |
| AGCO | Ag516559 | A-AG516559 |
| AGCO | Ag516861 | A-AG516861 |
| AGCO | Ag516558 | A-AG516558 |
| AGCO | Ag517279 | A-AG517279 |
| AGCO | 233213M1 | A-233213M1 |
| AGCO | Gr17880810 | A-GR17880810 |
| AGCO | 290331 | A-290331 |
| AGCO | 3035569M1 | A-3035569M1 |
| AGCO | 3035568M2 | A-3035568M2 |
| AGCO | X697.170.100.000 | A-X697.170.100.000 |
| AGCO | 46488200 | A-46488200 |
| AGCO | X697.171.900.000 | A-X697.171.900.000 |
| AGCO | X697.171.901.000 | A-X697.171.901.000 |
| AGCO | X697.172.100.000 | A-X697.172.100.000 |
| AGCO | 41991400 | A-41991400 |
| AGCO | 063211T1 | A-063211T1 |
| AGCO | 765173 | A-765173 |
| AGCO | 218560M91 | A-218560M91 |
| AGCO | 765174 | A-765174 |
| AGCO | 039631T1 | A-039631T1 |
| AGCO | 6211081M1 | A-6211081M1 |
| AGCO | 7855349 | A-7855349 |
| AGCO | 6203764M1 | A-6203764M1 |
| AGCO | 41992300 | A-41992300 |
| AGCO | 065188T1 | A-065188T1 |
| AGCO | 063212T1 | A-063212T1 |
| AGCO | 41992000 | A-41992000 |
| AGCO | 41978100 | A-41978100 |
| AGCO | 068154T1 | A-068154T1 |
| AGCO | 6210826M1 | A-6210826M1 |
| AGCO | 26735939 | A-26735939 |
| AGCO | 6209374M1 | A-6209374M1 |
| AGCO | 41992100 | A-41992100 |
| AGCO | 41992200 | A-41992200 |
| AGCO | 6203462M2 | A-6203462M2 |
| AGCO | 41977800 | A-41977800 |
| AGCO | 41977700 | A-41977700 |
| AGCO | 41990049 | A-41990049 |
| AGCO | 41990047 | A-41990047 |
| AGCO | 6210914M1 | A-6210914M1 |
| AGCO | 41990048 | A-41990048 |
| AGCO | 41977600 | A-41977600 |

AGCO



| OEM | OEM  Part No. | PIX  Part No. | OEM | OEM  Part No. | PIX  Part No. |
|------|--|--|------|--|--|
| AGCO | 41977900 | A-41977900 | AGCO | 41990059 | A-41990059 |
| AGCO | 41978700 | A-41978700 | AGCO | 41990064 | A-41990064 |
| AGCO | 3370141M1 | A-3370141M1 | AGCO | 41978000 | A-41978000 |
| AGCO | 26732820 | A-26732820 | AGCO | 700708547 | A-700708547 |
| AGCO | 6201516M1 | A-6201516M1 | AGCO | 700715554 | A-700715554 |
| AGCO | 6211072M1 | A-6211072M1 | AGCO | 685081785 | A-685081785 |
| AGCO | 6219167M1 | A-6219167M1 | AGCO | X696.614.802.000 | A-X696.614.802.000 |
| AGCO | 6212014M1 | A-6212014M1 | AGCO | 3383045M1 | A-3383045M1 |
| AGCO | 6211508M1 | A-6211508M1 | AGCO | 3619357M1 | A-3619357M1 |
| AGCO | 320551M1 | A-320551M1 | AGCO | 3700658M91 | A-3700658M91 |
| AGCO | 856112 | A-856112 | AGCO | 3761507M91 | A-3761507M91 |
| AGCO | 28274029 | A-28274029 | AGCO | X696.611.611.000 | A-X696.611.611.000 |
| AGCO | 270412 | A-270412 | AGCO | X696.612.000.000 | A-X696.612.000.000 |
| AGCO | 41990054 | A-41990054 | AGCO | X696.612.200.000 | A-X696.612.200.000 |
| AGCO | 6202555M1 | A-6202555M1 | AGCO | X696.612.400.000 | A-X696.612.400.000 |
| AGCO | 41990063 | A-41990063 | AGCO | X696.612.600.000 | A-X696.612.600.000 |
| AGCO | 41990055 | A-41990055 | AGCO | X696.612.602.000 | A-X696.612.602.000 |
| AGCO | 270791 | A-270791 | AGCO | X696.612.811.000 | A-X696.612.811.000 |
| AGCO | 41995600 | A-41995600 | AGCO | X696.612.913.000 | A-X696.612.913.000 |
| AGCO | 856047 | A-856047 | AGCO | X696.613.101.000 | A-X696.613.101.000 |
| AGCO | 71390209 | A-71390209 | AGCO | X696.613.501.000 | A-X696.613.501.000 |
| AGCO | 41994600 | A-41994600 | AGCO | X696.613.801.000 | A-X696.613.801.000 |
| AGCO | 71385693 | A-71385693 | AGCO | X696.613.901.000 | A-X696.613.901.000 |
| AGCO | 71387775 | A-71387775 | AGCO | X696.614.513.000 | A-X696.614.513.000 |
| AGCO | 41990053 | A-41990053 | AGCO | X696.614.601.000 | A-X696.614.601.000 |
| AGCO | 71399562 | A-71399562 | AGCO | X696.614.913.000 | A-X696.614.913.000 |
| AGCO | 41991600 | A-41991600 | AGCO | X696.615.002.000 | A-X696.615.002.000 |
| AGCO | 3036551M1 | A-3036551M1 | AGCO | X696.615.200.000 | A-X696.615.200.000 |
| AGCO | 344311320 | A-344311320 | AGCO | X696.615.301.000 | A-X696.615.301.000 |
| AGCO | 26732815 | A-26732815 | AGCO | X696.615.401.000 | A-X696.615.401.000 |
| AGCO | 6211083M1 | A-6211083M1 | AGCO | X696.615.601.000 | A-X696.615.601.000 |
| AGCO | 912877M1 | A-912877M1 | AGCO | X696.615.704.000 | A-X696.615.704.000 |
| AGCO | 843810M1 | A-843810M1 | AGCO | X696.616.000.000 | A-X696.616.000.000 |
| AGCO | 41990058 | A-41990058 | AGCO | X696.616.102.000 | A-X696.616.102.000 |
| AGCO | 41990056 | A-41990056 | AGCO | X696.616.201.000 | A-X696.616.201.000 |
| AGCO | 41990057 | A-41990057 | AGCO | X696.616.300.000 | A-X696.616.300.000 |
| AGCO | 41993800 | A-41993800 | AGCO | X696.616.600.000 | A-X696.616.600.000 |
| AGCO | 526155 | A-526155 | AGCO | X696.616.702.000 | A-X696.616.702.000 |
| AGCO | 527975 | A-527975 | AGCO | X696.616.800.000 | A-X696.616.800.000 |
| AGCO | 6211082M1 | A-6211082M1 | AGCO | X696.616.913.000 | A-X696.616.913.000 |
| AGCO | 41990065 | A-41990065 | AGCO | X696.617.800.000 | A-X696.617.800.000 |
| AGCO | 41994500 | A-41994500 | AGCO | X696.617.900.000 | A-X696.617.900.000 |
| AGCO | 105654W1 | A-105654W1 | AGCO | 1686615M91 | A-1686615M91 |
| AGCO | 6202933M1 | A-6202933M1 | AGCO | X696.617.701.000 | A-X696.617.701.000 |
| AGCO | 6211079M1 | A-6211079M1 | AGCO | 3581635M1 | A-3581635M1 |
| AGCO | X697.173.600.000 | A-X697.173.600.000 | AGCO | 3780908M91 | A-3780908M91 |
| AGCO | 26733312 | A-26733312 | AGCO | 5115483M1 | A-5115483M1 |

AGCO

| OEM | OEM  Part No. | PIX  Part No. |
|------|--|--|
| AGCO | 6216981M1 | A-6216981M1 |
| AGCO | X696.619.200.000 | A-X696.619.200.000 |
| AGCO | X696.622.700.000 | A-X696.622.700.000 |
| AGCO | X696.622.800.000 | A-X696.622.800.000 |
| AGCO | X696.622.900.000 | A-X696.622.900.000 |
| AGCO | X696.623.000.000 | A-X696.623.000.000 |
| AGCO | X696.623.200.000 | A-X696.623.200.000 |
| AGCO | X696.623.300.000 | A-X696.623.300.000 |
| AGCO | X696.623.400.000 | A-X696.623.400.000 |
| AGCO | X696.623.600.000 | A-X696.623.600.000 |
| AGCO | X696.623.700.000 | A-X696.623.700.000 |
| AGCO | X696.623.800.000 | A-X696.623.800.000 |
| AGCO | X696.623.900.000 | A-X696.623.900.000 |
| AGCO | X696.624.100.000 | A-X696.624.100.000 |
| AGCO | X696.624.200.000 | A-X696.624.200.000 |
| AGCO | X696.624.300.000 | A-X696.624.300.000 |
| AGCO | X696.624.400.000 | A-X696.624.400.000 |
| AGCO | X696.624.500.000 | A-X696.624.500.000 |
| AGCO | X696.624.800.000 | A-X696.624.800.000 |
| AGCO | X696.642.000.000 | A-X696.642.000.000 |
| AGCO | 049880T1 | A-049880T1 |
| AGCO | 3777748M2 | A-3777748M2 |
| AGCO | 3808730M1 | A-3808730M1 |
| AGCO | 1614371M1 | A-1614371M1 |
| AGCO | 3386190M91 | A-3386190M91 |
| AGCO | 3595070M91 | A-3595070M91 |
| AGCO | 3614715M2 | A-3614715M2 |
| AGCO | 3780061M91 | A-3780061M91 |
| AGCO | 521370M1 | A-521370M1 |
| AGCO | 3614715M1 | A-3614715M1 |
| AGCO | Wr10487 | A-WR10487 |
| AGCO | 41972100 | A-41972100 |
| AGCO | 41972200 | A-41972200 |
| AGCO | 41972300 | A-41972300 |
| AGCO | 583824M1 | A-583824M1 |
| AGCO | 41972800 | A-41972800 |
| AGCO | 41973000 | A-41973000 |
| AGCO | 41974300 | A-41974300 |
| AGCO | 41976200 | A-41976200 |
| AGCO | 3404339850 | A-3404339850 |
| AGCO | 3404339860 | A-3404339860 |
| AGCO | 41978500 | A-41978500 |
| AGCO | 41989900 | A-41989900 |
| AGCO | 969186M1 | A-969186M1 |
| AGCO | 3372217M1 | A-3372217M1 |
| AGCO | 3036278M1 | A-3036278M1 |
| AGCO | 45055100 | A-45055100 |



| OEM | OEM  Part No. | PIX  Part No. |
|------|--|--|
| AGCO | 960972M1 | A-960972M1 |
| AGCO | 49906200 | A-49906200 |
| AGCO | 1604464M1 | A-1604464M1 |
| AGCO | 3106033M1 | A-3106033M1 |
| AGCO | 41995000 | A-41995000 |
| AGCO | 407189M91 | A-407189M91 |
| AGCO | 41996400 | A-41996400 |
| AGCO | 41996100 | A-41996100 |
| AGCO | 121745 | A-121745 |
| AGCO | 531316M1 | A-531316M1 |
| AGCO | 1721710M1 | A-1721710M1 |
| AGCO | 122129 | A-122129 |
| AGCO | 41990007 | A-41990007 |
| AGCO | 41997200 | A-41997200 |
| AGCO | 41996500 | A-41996500 |
| AGCO | 122968 | A-122968 |
| AGCO | 123027 | A-123027 |
| AGCO | 41997500 | A-41997500 |
| AGCO | 26732797 | A-26732797 |
| AGCO | 41997600 | A-41997600 |
| AGCO | 41996300 | A-41996300 |
| AGCO | 41999800 | A-41999800 |
| AGCO | 41999700 | A-41999700 |
| AGCO | 407218M1 | A-407218M1 |
| AGCO | 1621182M1 | A-1621182M1 |
| AGCO | 3193693M2 | A-3193693M2 |
| AGCO | 46301055 | A-46301055 |
| AGCO | 410195M1 | A-410195M1 |
| AGCO | X696.640.500.000 | A-X696.640.500.000 |
| AGCO | X696.640.600.000 | A-X696.640.600.000 |
| AGCO | 3920712M | A-3920712M |
| AGCO | 3042011M1 | A-3042011M1 |
| AGCO | 3042012M1 | A-3042012M1 |
| AGCO | 201108473 | A-201108473 |
| AGCO | 3043154M1 | A-3043154M1 |
| AGCO | 3043153M1 | A-3043153M1 |
| AGCO | 41995700 | A-41995700 |
| AGCO | 41981400 | A-41981400 |
| AGCO | 41980300 | A-41980300 |
| AGCO | 703899 | A-703899 |
| AGCO | 340435126 | A-340435126 |
| AGCO | 71170490 | A-71170490 |
| AGCO | 833857M3 | A-833857M3 |
| AGCO | 621320M2 | A-621320M2 |
| AGCO | 71197876 | A-71197876 |
| AGCO | 41980800 | A-41980800 |
| AGCO | 053640T1 | A-053640T1 |



AGCO

| OEM | OEM  Part No. | PIX  Part No. |
|------|--|--|
| AGCO | 41981500 | A-41981500 |
| AGCO | 41990014 | A-41990014 |
| AGCO | 41990022 | A-41990022 |
| AGCO | 41990021 | A-41990021 |
| AGCO | 3920203M | A-3920203M |
| AGCO | 41999100 | A-41999100 |
| AGCO | 3656765M1 | A-3656765M1 |
| AGCO | 41991100 | A-41991100 |
| AGCO | 122253 | A-122253 |
| AGCO | 41990019 | A-41990019 |
| AGCO | 41990026 | A-41990026 |
| AGCO | 41990011 | A-41990011 |
| AGCO | 41990020 | A-41990020 |
| AGCO | 41990012 | A-41990012 |
| AGCO | 3700656M1 | A-3700656M1 |
| AGCO | 41921700 | A-41921700 |
| AGCO | 122075 | A-122075 |
| AGCO | X696615401000 | A-X696615401000 |
| AGCO | X697.174.000.000 | A-X697.174.000.000 |
| AGCO | X696619413000 | A-X696619413000 |
| AGCO | X696618200000 | A-X696618200000 |
| AGCO | 685121555 | A-685121555 |
| AGCO | V685121555 | A-V685121555 |
| AGCO | 685121570 | A-685121570 |
| AGCO | 685121725 | A-685121725 |
| AGCO | V685121725 | A-V685121725 |
| AGCO | 685121845 | A-685121845 |
| AGCO | V685121845 | A-V685121845 |
| AGCO | 685121860 | A-685121860 |
| AGCO | 685121880 | A-685121880 |
| AGCO | V685121860 | A-V685121860 |
| AGCO | 685121945 | A-685121945 |
| AGCO | V685121945 | A-V685121945 |
| AGCO | 685121965 | A-685121965 |
| AGCO | V685121965 | A-V685121965 |
| AGCO | 685122020 | A-685122020 |
| AGCO | V685122020 | A-V685122020 |
| AGCO | 4293007M2 | A-4293007M2 |
| AGCO | 6290138M1 | A-6290138M1 |
| AGCO | 340433141 | A-340433141 |
| AGCO | 700719689 | A-700719689 |
| AGCO | 41910400 | A-41910400 |
| AGCO | D41910400 | A-D41910400 |
| AGCO | 340433195 | A-340433195 |
| AGCO | X696622000000 | A-X696622000000 |
| AGCO | X696519400000 | A-X696519400000 |
| AGCO | 685141585 | A-685141585 |



| OEM | OEM  Part No. | PIX  Part No. |
|------|--|--|
| AGCO | V685141585 | A-V685141585 |
| AGCO | 3315897M1 | A-3315897M1 |
| AGCO | 836007765 | A-836007765 |
| AGCO | V836007765 | A-V836007765 |
| AGCO | X696633800000 | A-X696633800000 |
| AGCO | 6263504M1 | A-6263504M1 |
| AGCO | X696635500000 | A-X696635500000 |
| AGCO | 3590944M1 | A-3590944M1 |
| AGCO | 340433280 | A-340433280 |
| AGCO | 402177M1 | A-402177M1 |
| AGCO | 340344276 | A-340344276 |
| AGCO | 26746958 | A-26746958 |
| AGCO | D41932800 | A-D41932800 |
| AGCO | 6247232M1 | A-6247232M1 |
| AGCO | 6247231M1 | A-6247231M1 |
| AGCO | 26746968 | A-26746968 |
| AGCO | 321034M3 | A-321034M3 |
| AGCO | 6230964M1 | A-6230964M1 |
| AGCO | 26746970 | A-26746970 |
| AGCO | 6248667M1 | A-6248667M1 |
| AGCO | 41944700 | A-41944700 |
| AGCO | D41944700 | A-D41944700 |
| AGCO | 26746971 | A-26746971 |
| AGCO | X696.629.509.000 | A-X696.629.509.000 |
| AGCO | X696629509000 | A-X696629509000 |
| AGCO | 600P02 | A-600P02 |
| AGCO | 411020M1 | A-411020M1 |
| AGCO | 1604055M2 | A-1604055M2 |
| AGCO | 418209M1 | A-418209M1 |
| AGCO | 6220987M1 | A-6220987M1 |
| AGCO | 112366410100 | A-112366410100 |
| AGCO | 6284282M1 | A-6284282M1 |
| AGCO | 063971T2 | A-063971T2 |
| AGCO | 6231843M1 | A-6231843M1 |
| AGCO | 1731014M1 | A-1731014M1 |
| AGCO | 87041732C | A-87041732C |
| AGCO | 340433477 | A-340433477 |
| AGCO | 6217977M1 | A-6217977M1 |
| AGCO | 6230739M1 | A-6230739M1 |
| AGCO | 048392T1 | A-048392T1 |
| AGCO | D41957800 | A-D41957800 |
| AGCO | Xp12472 | A-XP12472 |
| AGCO | 71447314 | A-71447314 |
| AGCO | 26746972 | A-26746972 |
| AGCO | 1730367M1 | A-1730367M1 |
| AGCO | 6248670M1 | A-6248670M1 |
| AGCO | 6266289M1 | A-6266289M1 |



AGCO

| OEM | OEM  Part No. | PIX  Part No. |
|------|--|--|
| AGCO | 6268912M1 | A-6268912M1 |
| AGCO | 6237301M1 | A-6237301M1 |
| AGCO | 28263120 | A-28263120 |
| AGCO | 6220817M1 | A-6220817M1 |
| AGCO | 6213293M1 | A-6213293M1 |
| AGCO | 6213293M2 | A-6213293M2 |
| AGCO | 6248653M1 | A-6248653M1 |
| AGCO | 6235815M1 | A-6235815M1 |
| AGCO | 6248647M1 | A-6248647M1 |
| AGCO | 6235825M1 | A-6235825M1 |
| AGCO | 6248658M1 | A-6248658M1 |
| AGCO | 344311171 | A-344311171 |
| AGCO | 6298767M1 | A-6298767M1 |
| AGCO | 6232489M1 | A-6232489M1 |
| AGCO | 6230741M1 | A-6230741M1 |
| AGCO | 6289543M1 | A-6289543M1 |
| AGCO | 6298761M1 | A-6298761M1 |
| AGCO | 344311278 | A-344311278 |
| AGCO | 34431128 | A-34431128 |
| AGCO | 6290856M1 | A-6290856M1 |
| AGCO | 71442230 | A-71442230 |
| AGCO | 71440999 | A-71440999 |
| AGCO | 6289544M1 | A-6289544M1 |
| AGCO | 6303174M1 | A-6303174M1 |
| AGCO | 71442255 | A-71442255 |
| AGCO | 344311132 | A-344311132 |
| AGCO | 6231546M1 | A-6231546M1 |
| AGCO | 71448503 | A-71448503 |
| AGCO | 6289545M1 | A-6289545M1 |
| AGCO | 6268436M1 | A-6268436M1 |
| AGCO | 700719205 | A-700719205 |
| AGCO | 71462784 | A-71462784 |
| AGCO | 6294242M1 | A-6294242M1 |
| AGCO | 71462787 | A-71462787 |
| AGCO | 71447401 | A-71447401 |
| AGCO | 71449576 | A-71449576 |
| AGCO | 6154998 | A-6154998 |
| AGCO | 6231547M1 | A-6231547M1 |
| AGCO | 344312129 | A-344312129 |
| AGCO | 6159053 | A-6159053 |
| AGCO | 71448508 | A-71448508 |
| AGCO | 6153715 | A-6153715 |
| AGCO | 26746997 | A-26746997 |
| AGCO | 26746996 | A-26746996 |
| AGCO | X696.989.501.000 | A-X696.989.501.000 |
| AGCO | 71441902 | A-71441902 |
| AGCO | 6227303M1 | A-6227303M1 |

| OEM | OEM  Part No. | PIX  Part No. |
|------|--|--|
| AGCO | 71440993 | A-71440993 |
| AGCO | 6220518M1 | A-6220518M1 |
| AGCO | 6237294M1 | A-6237294M1 |
| AGCO | 28263240 | A-28263240 |
| AGCO | 344311238 | A-344311238 |
| AGCO | 344311240 | A-344311240 |
| AGCO | 344311233 | A-344311233 |
| AGCO | 344311237 | A-344311237 |
| AGCO | 344411229 | A-344411229 |
| AGCO | 6303185M1 | A-6303185M1 |
| AGCO | 26746995 | A-26746995 |
| AGCO | 1141641 | A-1141641 |
| AGCO | 344311235 | A-344311235 |
| AGCO | 344311232 | A-344311232 |
| AGCO | 3443112320 | A-3443112320 |
| AGCO | 71441879 | A-71441879 |
| AGCO | 344311231 | A-344311231 |
| AGCO | 3443112310 | A-3443112310 |
| AGCO | 344311229 | A-344311229 |
| AGCO | 344311236 | A-344311236 |
| AGCO | 344311234 | A-344311234 |
| AGCO | 6289542M1 | A-6289542M1 |
| AGCO | 71430816 | A-71430816 |
| AGCO | E040T07 | A-E040T07 |
| AGCO | 6219415M1 | A-6219415M1 |
| AGCO | 71448515 | A-71448515 |
| AGCO | 6154285 | A-6154285 |
| AGCO | 6237302M1 | A-6237302M1 |
| AGCO | 7061016M1 | A-7061016M1 |
| AGCO | 1671988M1 | A-1671988M1 |
| AGCO | 700721267 | A-700721267 |
| AGCO | 344311309 | A-344311309 |
| AGCO | 344311311 | A-344311311 |
| AGCO | 6219414M1 | A-6219414M1 |
| AGCO | 6232589M1 | A-6232589M1 |
| AGCO | 344411318 | A-344411318 |
| AGCO | 6218984M1 | A-6218984M1 |
| AGCO | 344311239 | A-344311239 |
| AGCO | 6217825M1 | A-6217825M1 |
| AGCO | 344311313 | A-344311313 |
| AGCO | 26746973 | A-26746973 |
| AGCO | 6247944M1 | A-6247944M1 |
| AGCO | 7059737M1 | A-7059737M1 |
| AGCO | 6247230M1 | A-6247230M1 |
| AGCO | 71427343 | A-71427343 |
| AGCO | 6219408M1 | A-6219408M1 |
| AGCO | 28263409 | A-28263409 |



AGCO

| OEM | OEM  Part No. | PIX  Part No. |
|------|--|--|
| AGCO | 6272560M1 | A-6272560M1 |
| AGCO | 41994300 | A-41994300 |
| AGCO | 28264254 | A-28264254 |
| AGCO | 6153723 | A-6153723 |
| AGCO | 6153386 | A-6153386 |
| AGCO | 26749057 | A-26749057 |
| AGCO | 3920419M | A-3920419M |
| AGCO | 3920562M | A-3920562M |
| AGCO | 26746998 | A-26746998 |
| AGCO | 6247946M1 | A-6247946M1 |
| AGCO | 6237300M1 | A-6237300M1 |
| AGCO | 28263119 | A-28263119 |
| AGCO | 650.623.030.550 | A-650.623.030.550 |
| AGCO | 685061555 | A-685061555 |
| AGCO | V685061555 | A-V685061555 |
| AGCO | 685061585 | A-685061585 |
| AGCO | V685061585 | A-V685061585 |
| AGCO | 685061740 | A-685061740 |
| AGCO | V685061740 | A-V685061740 |
| AGCO | 685081290 | A-685081290 |
| AGCO | V685081290 | A-V685081290 |
| AGCO | 685081315 | A-685081315 |
| AGCO | V685081315 | A-V685081315 |
| AGCO | 685081680 | A-685081680 |
| AGCO | V685081680 | A-V685081680 |
| AGCO | 685081710 | A-685081710 |
| AGCO | V685081710 | A-V685081710 |
| AGCO | 685081730 | A-685081730 |
| AGCO | 685081745 | A-685081745 |
| AGCO | V685081745 | A-V685081745 |
| AGCO | F718202040010 | A-F718202040010 |
| AGCO | 685081800 | A-685081800 |
| AGCO | V685081800 | A-V685081800 |
| AGCO | 685081850 | A-685081850 |
| AGCO | V685081850 | A-V685081850 |
| AGCO | 685081895 | A-685081895 |
| AGCO | V685081895 | A-V685081895 |
| AGCO | 685081920 | A-685081920 |
| AGCO | V685081920 | A-V685081920 |
| AGCO | 500252D1 | A-500252D1 |
| AGCO | 500251D1 | A-500251D1 |
| AGCO | 685082300 | A-685082300 |
| AGCO | V685082300 | A-V685082300 |
| AGCO | F524200040160 | A-F524200040160 |
| AGCO | X696614700000 | A-X696614700000 |
| AGCO | X696615408000 | A-X696615408000 |
| AGCO | X696615600000 | A-X696615600000 |



| OEM | OEM  Part No. | PIX  Part No. |
|------|--|--|
| AGCO | X696610600000 | A-X696610600000 |
| AGCO | X696612313000 | A-X696612313000 |
| AGCO | X696612500000 | A-X696612500000 |
| AGCO | X696.612.900.000 | A-X696.612.900.000 |
| AGCO | X696612900000 | A-X696612900000 |
| AGCO | X696.613.313.000 | A-X696.613.313.000 |
| AGCO | X696613308000 | A-X696613308000 |
| AGCO | X696613313000 | A-X696613313000 |
| AGCO | X696613600000 | A-X696613600000 |
| AGCO | 684101000 | A-684101000 |
| AGCO | V684101000 | A-V684101000 |
| AGCO | 684101025 | A-684101025 |
| AGCO | V684101025 | A-V684101025 |
| AGCO | X696614513000 | A-X696614513000 |
| AGCO | X696.614.602.000 | A-X696.614.602.000 |
| AGCO | X696614601000 | A-X696614601000 |
| AGCO | 684101100 | A-684101100 |
| AGCO | V684101100 | A-V684101100 |
| AGCO | 684101125 | A-684101125 |
| AGCO | V684101125 | A-V684101125 |
| AGCO | 684101150 | A-684101150 |
| AGCO | V684101150 | A-V684101150 |
| AGCO | 056148T1 | A-056148T1 |
| AGCO | 684101175 | A-684101175 |
| AGCO | V684101175 | A-V684101175 |
| AGCO | X696613901000 | A-X696613901000 |
| AGCO | 684101238 | A-684101238 |
| AGCO | V684101238 | A-V684101238 |
| AGCO | X696616000000 | A-X696616000000 |
| AGCO | X696617900000 | A-X696617900000 |
| AGCO | X696612602000 | A-X696612602000 |
| AGCO | X696612400000 | A-X696612400000 |
| AGCO | 684101350 | A-684101350 |
| AGCO | V684101350 | A-V684101350 |
| AGCO | X696615301000 | A-X696615301000 |
| AGCO | 072729T1 | A-072729T1 |
| AGCO | 054315T1 | A-054315T1 |
| AGCO | 053650T1 | A-053650T1 |
| AGCO | 069998T1 | A-069998T1 |
| AGCO | 070460T1 | A-070460T1 |
| AGCO | X696.616.702.010 | A-X696.616.702.010 |
| AGCO | 069999T1 | A-069999T1 |
| AGCO | 070461T1 | A-070461T1 |
| AGCO | 6217950M1 | A-6217950M1 |
| AGCO | X696611611000 | A-X696611611000 |
| AGCO | X696616102000 | A-X696616102000 |
| AGCO | X696616300000 | A-X696616300000 |



AGCO

| OEM | OEM  Part No. | PIX  Part No. |
|------|--|--|
| AGCO | 056150T1 | A-056150T1 |
| AGCO | X696612811000 | A-X696612811000 |
| AGCO | X696613101000 | A-X696613101000 |
| AGCO | X696613801000 | A-X696613801000 |
| AGCO | X696640600000 | A-X696640600000 |
| AGCO | 6236823M1 | A-6236823M1 |
| AGCO | 684121050 | A-684121050 |
| AGCO | V684121050 | A-V684121050 |
| AGCO | 684121075 | A-684121075 |
| AGCO | V684121075 | A-V684121075 |
| AGCO | X696624600000 | A-X696624600000 |
| AGCO | 684121100 | A-684121100 |
| AGCO | 054607T1 | A-054607T1 |
| AGCO | V684121100 | A-V684121100 |
| AGCO | X696619200000 | A-X696619200000 |
| AGCO | 684121125 | A-684121125 |
| AGCO | V684121125 | A-V684121125 |
| AGCO | X696623700000 | A-X696623700000 |
| AGCO | 6201102M1 | A-6201102M1 |
| AGCO | 049798T1 | A-049798T1 |
| AGCO | X696623900000 | A-X696623900000 |
| AGCO | 1682684M2 | A-1682684M2 |
| AGCO | 6902 | A-0006902 |
| AGCO | V684121225 | A-V684121225 |
| AGCO | 684121225 | A-684121225 |
| AGCO | 684121250 | A-684121250 |
| AGCO | V684121250 | A-V684121250 |
| AGCO | X696624400000 | A-X696624400000 |
| AGCO | 6906 | A-0006906 |
| AGCO | 1482511M2 | A-1482511M2 |
| AGCO | 3148053M91 | A-3148053M91 |
| AGCO | 072727T1 | A-072727T1 |
| AGCO | 489734M2 | A-489734M2 |
| AGCO | 040560T1 | A-040560T1 |
| AGCO | 984909360 | A-984909360 |
| AGCO | 3815255M1 | A-3815255M1 |
| AGCO | 6201932M1 | A-6201932M1 |
| AGCO | 6201602M91 | A-6201602M91 |
| AGCO | 6203323M91 | A-6203323M91 |
| AGCO | 054269T1 | A-054269T1 |
| AGCO | 6900 | A-6900 |
| AGCO | 026160T1 | A-026160T1 |
| AGCO | 026161T1 | A-026161T1 |
| AGCO | 056149T1 | A-056149T1 |
| AGCO | 3145135M91 | A-3145135M91 |
| AGCO | 684121550 | A-684121550 |
| AGCO | V684121550 | A-V684121550 |

| OEM | OEM  Part No. | PIX  Part No. |
|------|--|--|
| AGCO | 684121575 | A-684121575 |
| AGCO | V684121575 | A-V684121575 |
| AGCO | 6214645M1 | A-6214645M1 |
| AGCO | 684121600 | A-684121600 |
| AGCO | V684121600 | A-V684121600 |
| AGCO | 036720T1 | A-036720T1 |
| AGCO | 684121625 | A-684121625 |
| AGCO | V684121625 | A-V684121625 |
| AGCO | 684121650 | A-684121650 |
| AGCO | V684121650 | A-V684121650 |
| AGCO | 684121675 | A-684121675 |
| AGCO | V684121675 | A-V684121675 |
| AGCO | 034699T1 | A-034699T1 |
| AGCO | 034948T1 | A-034948T1 |
| AGCO | 3587700M1 | A-3587700M1 |
| AGCO | 3587701M91 | A-3587701M91 |
| AGCO | 021077T1 | A-021077T1 |
| AGCO | 021078T1 | A-021078T1 |
| AGCO | X696622800000 | A-X696622800000 |
| AGCO | 684120825 | A-684120825 |
| AGCO | V684120825 | A-V684120825 |
| AGCO | 684120875 | A-684120875 |
| AGCO | V684120875 | A-V684120875 |
| AGCO | 684120900 | A-684120900 |
| AGCO | 684120918 | A-684120918 |
| AGCO | 684120925 | A-684120925 |
| AGCO | V684120925 | A-V684120925 |
| AGCO | 684120950 | A-684120950 |
| AGCO | V684120950 | A-V684120950 |
| AGCO | 684120975 | A-684120975 |
| AGCO | V684120975 | A-V684120975 |
| AGCO | 684120992 | A-684120992 |
| AGCO | V684120992 | A-V684120992 |
| AGCO | 7061235M1 | A-7061235M1 |
| AGCO | 10487 | A-10487 |
| AGCO | D41972300 | A-D41972300 |
| AGCO | 6230869M1 | A-6230869M1 |
| AGCO | 340433988 | A-340433988 |
| AGCO | 6230019M1 | A-6230019M1 |
| AGCO | 340433985 | A-340433985 |
| AGCO | 340433986 | A-340433986 |
| AGCO | 41978600 | A-41978600 |
| AGCO | 6275380M1 | A-6275380M1 |
| AGCO | 6275381M1 | A-6275381M1 |
| AGCO | 340435120K | A-340435120K |
| AGCO | 833857M5 | A-833857M5 |
| AGCO | 340435146K | A-340435146K |

AGCO



| OEM | OEM  Part No. | PIX  Part No. |
|------|--|--|
| AGCO | 069361T1 | A-069361T1 |
| AGCO | 069362T1 | A-069362T1 |
| AGCO | 344435155 | A-344435155 |
| AGCO | 41980500 | A-41980500 |
| AGCO | 117510515000 | A-117510515000 |
| AGCO | 6230012M1 | A-6230012M1 |
| AGCO | 6219396M1 | A-6219396M1 |
| AGCO | 124977 | A-124977 |
| AGCO | 41990007X | A-41990007X |
| AGCO | 6801631 | A-6801631 |
| AGCO | 650.203.040.010 | A-650.203.040.010 |
| AGCO | 7061926M1 | A-7061926M1 |
| AGCO | 41990027 | A-41990027 |
| AGCO | D41921801 | A-D41921801 |
| AGCO | 41921801 | A-41921801 |
| AGCO | 402608M3 | A-402608M3 |
| AGCO | X696614913000 | A-X696614913000 |
| AGCO | X696616913000 | A-X696616913000 |
| AGCO | X696612913000 | A-X696612913000 |
| AGCO | 6154847 | A-06154847 |
| AGCO | 1170290108 | A-1170-290-108.00 |
| AGCO | X696617701000 | A-X696617701000 |
| AGCO | 1976292 | A-197-6292 |
| AGCO | 1976290 | A-197-6290 |
| AGCO | 1123664101 | A-1123-664-101.00 |
| AGCO | 6155819 | A-06155819 |
| AGCO | 71444306 | A-71444306 |
| AGCO | Ag518702 | A-AG518702 |
| AGCO | Ag518297 | A-AG518297 |
| AGCO | Ag519946 | A-AG519946 |
| AGCO | Ag516760 | A-AG516760 |
| AGCO | 71380653 | A-71380653 |
| AGCO | 71381952 | A-71381952 |
| AGCO | 71440983 | A-71440983 |
| AGCO | 709979 | A-709979 |
| AGCO | 7855661 | A-7855661 |
| AGCO | 856328 | A-856328 |
| AGCO | 1D68066 | A-1D68066 |
| AGCO | 71390210 | A-71390210 |
| AGCO | 650623030550 | A-650623030550 |
| AGCO | 410215M1 | A-410215M1 |
| AGCO | V685081785 | A-V685081785 |
| AGCO | 650633020010 | A-650633020010 |
| AGCO | 651200010220 | A-651200010220 |
| AGCO | 650203010870 | A-650203010870 |
| AGCO | 2072949 | A-207-2949 |
| AGCO | X696611312000 | A-X696611312000 |

| OEM | OEM  Part No. | PIX  Part No. |
|------|--|--|
| AGCO | X696613902000 | A-X696613902000 |
| AGCO | 1686837M1 | A-1686837M1 |
| AGCO | 400875 | A-400875 |
| AGCO | 72028727 | A-72028727 |
| AGCO | 71409522 | A-71409522 |
| AGCO | 515757D1 | A-515757D1 |
| AGCO | Ag605632 | A-AG605632 |
| AGCO | Ag720324 | A-AG720324 |
| AGCO | 5016906M1 | A-5016906M1 |
| AGCO | 520305D1 | A-520305D1 |
| AGCO | Ag027148 | A-AG027148 |
| AGCO | 71399607 | A-71399607 |
| AGCO | Ag605631 | A-AG605631 |
| AGCO | 740640 | A-740640 |
| AGCO | 72120245 | A-72120245 |
| AGCO | 72120454 | A-72120454 |
| AGCO | 72120455 | A-72120455 |
| AGCO | 1057488M1 | A-1057488M1 |
| AGCO | 1055562M1 | A-1055562M1 |
| AGCO | 1065431M1 | A-1065431M1 |
| AGCO | 1042396M1 | A-1042396M1 |
| AGCO | Ag516922 | A-AG516922 |
| AGCO | 700704407 | A-700704407 |
| AGCO | 76171 | A-7617-1 |
| AGCO | 76172 | A-7617-2 |
| AGCO | Wr38791 | A-WR38791 |
| AGCO | 71500256 | A-71500256 |
| AGCO | Y855106 | A-Y855106 |
| AGCO | 742527 | A-742527 |
| AGCO | 834191M1 | A-834191M1 |
| AGCO | 743800 | A-743800 |
| AGCO | H153301C1 | A-H153301C1 |
| AGCO | W9810080 | A-W9810080 |
| AGCO | 740726 | A-740726 |
| AGCO | 70548863 | A-70548863 |
| AGCO | 747255 | A-747255 |
| AGCO | Y56580 | A-Y56580 |
| AGCO | Y57604 | A-Y57604 |
| AGCO | 70805114 | A-70805114 |
| AGCO | Y855254 | A-Y855254 |
| AGCO | H143876C1 | A-H143876C1 |
| AGCO | 747256 | A-747256 |
| AGCO | 857805 | A-857805 |
| AGCO | 747254 | A-747254 |
| AGCO | 743795 | A-743795 |
| AGCO | 71380655 | A-71380655 |
| AGCO | H143875C1 | A-H143875C1 |





AGCO

| OEM | OEM  Part No. | PIX  Part No. |
|------|--|--|
| AGCO | 744282 | A-744282 |
| AGCO | 56333 | A-56333 |
| AGCO | Y57083 | A-Y57083 |
| AGCO | 856062 | A-856062 |
| AGCO | 7855224 | A-7855224 |
| AGCO | N712489 | A-N712489 |
| AGCO | Y57760 | A-Y57760 |
| AGCO | 70548868 | A-70548868 |
| AGCO | 71130179 | A-71130179 |
| AGCO | 71140810 | A-71140810 |
| AGCO | 71172514 | A-71172514 |
| AGCO | 70508971 | A-70508971 |
| AGCO | 71381413 | A-71381413 |
| AGCO | 71364789 | A-71364789 |
| AGCO | 1175105150 | A-1175-105-150.00 |
| AGCO | 6627918 | A-6627918 |
| AGCO | 650203040011 | A-650203040010 |
| AGCO | D41979800 | A-D41979800 |
| AGCO | 55574 | A-0000055574 |
| AGCO | 6215259 | A-6215259 |
| AGCO | 3443111171 | A-3443111171 |
| AGCO | 340433198 | A-340433198 |
| AGCO | 340433197 | A-340433197 |
| AGCO | 340433476 | A-340433476 |
| AGCO | 340433985 | A-340433985 |
| AGCO | 340433986 | A-340433986 |



ALLIS GLEANER

| OEM | OEM  Part No. | PIX  Part No. |
|---------------|--|--|
| ALLIS GLEANER | 71336199 | A-71336199 |
| ALLIS GLEANER | 71312339 | A-71312339 |
| ALLIS GLEANER | 71188075 | A-71188075 |
| ALLIS GLEANER | 71316263 | A-71316263 |
| ALLIS GLEANER | 71319657 | A-71319657 |
| ALLIS GLEANER | 71325847 | A-71325847 |
| ALLIS GLEANER | 71339772 | A-71339772 |
| ALLIS GLEANER | 71354210 | A-71354210 |
| ALLIS GLEANER | 71358486 | A-71358486 |
| ALLIS GLEANER | 71363968 | A-71363968 |
| ALLIS GLEANER | 71139961 | A-71139961 |
| ALLIS GLEANER | 71153532 | A-71153532 |
| ALLIS GLEANER | 71194122 | A-71194122 |
| ALLIS GLEANER | 1320449 | A-1320449 |
| ALLIS GLEANER | 1336210 | A-1336210 |
| ALLIS GLEANER | 71183767 | A-71183767 |
| ALLIS GLEANER | 71358134 | A-71358134 |
| ALLIS GLEANER | 1322418 | A-1322418 |
| ALLIS GLEANER | 1347561 | A-1347561 |
| ALLIS GLEANER | 1347560 | A-1347560 |
| ALLIS GLEANER | 1175713 | A-1175713 |
| ALLIS GLEANER | 1176492 | A-1176492 |
| ALLIS GLEANER | 1334919 | A-1334919 |
| ALLIS GLEANER | 1316263 | A-1316263 |
| ALLIS GLEANER | 1309140 | A-1309140 |
| ALLIS GLEANER | 1328523 | A-1328523 |
| ALLIS GLEANER | 1339886 | A-1339886 |
| ALLIS GLEANER | 1325847 | A-1325847 |
| ALLIS GLEANER | 1118003 | A-1118003 |
| ALLIS GLEANER | 1309685 | A-1309685 |
| ALLIS GLEANER | 1188635 | A-1188635 |
| ALLIS GLEANER | 1139961 | A-1139961 |
| ALLIS GLEANER | 1189170 | A-1189170 |
| ALLIS GLEANER | 1337795 | A-1337795 |
| ALLIS GLEANER | 1147547 | A-1147547 |
| ALLIS GLEANER | 1147546 | A-1147546 |
| ALLIS GLEANER | 1310382 | A-1310382 |
| ALLIS GLEANER | 1164177 | A-1164177 |
| ALLIS GLEANER | 1309214 | A-1309214 |
| ALLIS GLEANER | 1161595 | A-1161595 |
| ALLIS GLEANER | 1342142 | A-1342142 |
| ALLIS GLEANER | 1165927 | A-1165927 |
| ALLIS GLEANER | 1139966 | A-1139966 |
| ALLIS GLEANER | 1188636 | A-1188636 |
| ALLIS GLEANER | 1177537 | A-1177537 |
| ALLIS GLEANER | 1173998 | A-1173998 |
| ALLIS GLEANER | 1336997 | A-1336997 |

ALLIS GLEANER

| OEM | OEM  Part No. | PIX  Part No. | OEM | OEM  Part No. | PIX  Part No. |
|---------------|--|--|---------------|--|--|
| ALLIS GLEANER | 1348999 | A-1348999 | ALLIS GLEANER | 1197878 | A-1197878 |
| ALLIS GLEANER | 1342143 | A-1342143 | ALLIS GLEANER | 11978782 | A-1197878-2 |
| ALLIS GLEANER | 1164350 | A-1164350 | ALLIS GLEANER | 1184327 | A-1184327 |
| ALLIS GLEANER | 1310381 | A-1310381 | ALLIS GLEANER | 1309571 | A-1309571 |
| ALLIS GLEANER | 1307200 | A-1307200 | ALLIS GLEANER | 1345785 | A-1345785 |
| ALLIS GLEANER | 1176400 | A-1176400 | ALLIS GLEANER | 70559863 | A-70559863 |
| ALLIS GLEANER | 1319657 | A-1319657 | ALLIS GLEANER | 1119007 | A-1119007 |
| ALLIS GLEANER | 1300867 | A-1300867 | ALLIS GLEANER | 71320499 | A-71320499 |
| ALLIS GLEANER | 1139622 | A-1139622 | ALLIS GLEANER | 713645141 | A-71364514-1 |
| ALLIS GLEANER | 1324690 | A-1324690 | ALLIS GLEANER | 1172562 | A-1172562 |
| ALLIS GLEANER | 1326830 | A-1326830 | ALLIS GLEANER | 621089 | A-621089 |
| ALLIS GLEANER | 1187728 | A-1187728 | ALLIS GLEANER | 1186454 | A-1186454 |
| ALLIS GLEANER | 1310380 | A-1310380 | ALLIS GLEANER | 1306200 | A-1306200 |
| ALLIS GLEANER | 1139962 | A-1139962 | ALLIS GLEANER | 1177795 | A-1177795 |
| ALLIS GLEANER | 1309150 | A-1309150 | ALLIS GLEANER | 1183251 | A-1183251 |
| ALLIS GLEANER | 1313804 | A-1313804 | ALLIS GLEANER | 1342839 | A-1342839 |
| ALLIS GLEANER | 1306291 | A-1306291 | ALLIS GLEANER | 71342839 | A-71342839 |
| ALLIS GLEANER | 1135618 | A-1135618 | ALLIS GLEANER | 1340653 | A-1340653 |
| ALLIS GLEANER | 1139963 | A-1139963 | ALLIS GLEANER | 1321691 | A-1321691 |
| ALLIS GLEANER | 1300996 | A-1300996 | ALLIS GLEANER | 1337000 | A-1337000 |
| ALLIS GLEANER | 1318378 | A-1318378 | ALLIS GLEANER | 1349687 | A-1349687 |
| ALLIS GLEANER | 1316268 | A-1316268 | ALLIS GLEANER | 71349687 | A-71349687 |
| ALLIS GLEANER | 1167114 | A-1167114 | ALLIS GLEANER | 1305090 | A-1305090 |
| ALLIS GLEANER | 1188155 | A-1188155 | ALLIS GLEANER | 1321590 | A-1321590 |
| ALLIS GLEANER | 1194500 | A-1194500 | ALLIS GLEANER | 1342690 | A-1342690 |
| ALLIS GLEANER | 1302482 | A-1302482 | ALLIS GLEANER | 1309967 | A-1309967 |
| ALLIS GLEANER | 1336307 | A-1336307 | ALLIS GLEANER | 71361155 | A-71361155 |
| ALLIS GLEANER | 1346200 | A-1346200 | ALLIS GLEANER | 71336210 | A-71336210 |
| ALLIS GLEANER | 71359681 | A-71359681 | ALLIS GLEANER | 1125976 | A-1125976 |
| ALLIS GLEANER | 71333673 | A-71333673 | ALLIS GLEANER | 71351992 | A-71351992 |
| ALLIS GLEANER | 1188075 | A-1188075 | ALLIS GLEANER | 1322395 | A-1322395 |
| ALLIS GLEANER | 1177548 | A-1177548 | ALLIS GLEANER | 1135748 | A-1135748 |
| ALLIS GLEANER | 1325150 | A-1325150 | ALLIS GLEANER | 71135748 | A-71135748 |
| ALLIS GLEANER | 1159351 | A-1159351 | ALLIS GLEANER | 1116659 | A-1116659 |
| ALLIS GLEANER | 1164776 | A-1164776 | ALLIS GLEANER | 1172514 | A-1172514 |
| ALLIS GLEANER | 1159352 | A-1159352 | ALLIS GLEANER | 70527095 | A-70527095 |
| ALLIS GLEANER | 71344423 | A-71344423 | ALLIS GLEANER | 1197876 | A-1197876 |
| ALLIS GLEANER | 71330756 | A-71330756 | ALLIS GLEANER | 71375178 | A-71375178 |
| ALLIS GLEANER | 1197999 | A-1197999 | ALLIS GLEANER | 713641546 | A-71364154-6 |
| ALLIS GLEANER | 1188638 | A-1188638 | ALLIS GLEANER | 1125975 | A-1125975 |
| ALLIS GLEANER | 1314273 | A-1314273 | ALLIS GLEANER | 1170490 | A-1170490 |
| ALLIS GLEANER | 1334993 | A-1334993 | ALLIS GLEANER | 30653380 | A-30653-380 |
| ALLIS GLEANER | 1336993 | A-1336993 | ALLIS GLEANER | 71355788 | A-71355788 |
| ALLIS GLEANER | 1348989 | A-1348989 | ALLIS GLEANER | 1197899 | A-1197899 |
| ALLIS GLEANER | 71390120 | A-71390120 | ALLIS GLEANER | 1328562 | A-1328562 |
| ALLIS GLEANER | 1301877 | A-1301877 | ALLIS GLEANER | 71328562 | A-71328562 |
| ALLIS GLEANER | 1312339 | A-1312339 | ALLIS GLEANER | 1399514 | A-1399514 |



ALLIS GLEANER

| OEM | OEM  Part No. | PIX  Part No. |
|---------------|--|--|
| ALLIS GLEANER | 71363246 | A-71363246 |

BIZON

| | | |
|-------|-------------|----------------|
| BIZON | 9515076 | A-9515076 |
| BIZON | 825117 | A-825117 |
| BIZON | 9515075 | A-9515075 |
| BIZON | 9818873 | A-9818873 |
| BIZON | 51101131525 | A-51101131525 |
| BIZON | 51101131570 | A-51101131570 |
| BIZON | 51101132800 | A-51101132800 |
| BIZON | 51101171335 | A-51101171335 |
| BIZON | 51101171375 | A-51101171375 |
| BIZON | 51101171750 | A-51101171750 |
| BIZON | 51101171981 | A-51101171981 |
| BIZON | 51101172438 | A-51101172438 |
| BIZON | 51101222525 | A-51101222525 |
| BIZON | 51101321750 | A-51101321750 |
| BIZON | 51101622375 | A-51101622375 |
| BIZON | 51102173550 | A-51102173550 |
| BIZON | 51103172120 | A-51103172120 |
| BIZON | 51103172380 | A-51103172380 |
| BIZON | 51103172650 | A-51103172650 |
| BIZON | 51103173062 | A-51103173062 |
| BIZON | 51103173220 | A-51103173220 |
| BIZON | 51104172270 | A-51104172270 |
| BIZON | 51104173940 | A-51104173940 |
| BIZON | 51651222360 | A-51651222360 |
| BIZON | 51101132175 | A-51101132175 |
| BIZON | 51101171670 | A-51101171670 |
| BIZON | 51101171800 | A-51101171800 |
| BIZON | 51651175000 | A-51651175000 |
| BIZON | 51101222360 | A-51101222360 |
| BIZON | 51202175000 | A-51202175000 |
| BIZON | 84026042 | A-84026042 |
| BIZON | 84996133 | A-84996133 |
| BIZON | 615146 | A-615146 |
| BIZON | 51651221725 | A-51651221725 |
| BIZON | 51101255970 | A-51101255970 |
| BIZON | 51654172420 | A-51654172420 |
| BIZON | 639226.1 | A-639226.1 |
| BIZON | 614136 | A-614136 |
| BIZON | 615116 | A-615116 |
| BIZON | 51652172210 | A-51652172210 |
| BIZON | 972511286 | A-972511286 |
| BIZON | 1374310409 | A-1374-310-409 |
| BIZON | 51101173861 | A-51101173861 |



BIZON



| OEM | OEM  Part No. | PIX  Part No. |
|-------|--|--|
| BIZON | 972411280 | A-972411280 |
| BIZON | 615146 | A-615146 |
| BIZON | 614136 | A-614136 |
| BIZON | 615116 | A-615116 |

CASE IH



| | | |
|---------|------------|--------------|
| CASE IH | 440498A3 | A-440498A3 |
| CASE IH | 4221668157 | A-4221668157 |
| CASE IH | 87564450 | A-87564450 |
| CASE IH | 87527868 | A-87527868 |
| CASE IH | 380041A1 | A-380041A1 |
| CASE IH | 402368A1 | A-402368A1 |
| CASE IH | 402370A1 | A-402370A1 |
| CASE IH | A77938 | A-A77938 |
| CASE IH | 431784 | A-431784 |
| CASE IH | 5094418 | A-5094418 |
| CASE IH | A138001 | A-A138001 |
| CASE IH | 462133R1 | A-462133R1 |
| CASE IH | 400427A1 | A-400427A1 |
| CASE IH | 500371653 | A-500371653 |
| CASE IH | 317904A1 | A-317904A1 |
| CASE IH | 87282305 | A-87282305 |
| CASE IH | 87061591 | A-87061591 |
| CASE IH | 80921330 | A-80921330 |
| CASE IH | 825013 | A-825013 |
| CASE IH | 87375325 | A-87375325 |
| CASE IH | 4032808262 | A-4032808262 |
| CASE IH | 5140009 | A-5140009 |
| CASE IH | 87309958 | A-87309958 |
| CASE IH | 87402831 | A-87402831 |
| CASE IH | 87282333 | A-87282333 |
| CASE IH | 500369112 | A-500369112 |
| CASE IH | 98473705 | A-98473705 |
| CASE IH | 5140010 | A-5140010 |
| CASE IH | 4809680 | A-4809680 |
| CASE IH | 1966512C1 | A-1966512C1 |
| CASE IH | 47129821 | A-47129821 |
| CASE IH | 86514611 | A-86514611 |
| CASE IH | 86514616 | A-86514616 |
| CASE IH | 87567471 | A-87567471 |
| CASE IH | 87800129 | A-87800129 |
| CASE IH | 1806189C1 | A-1806189C1 |
| CASE IH | 5154152 | A-5154152 |
| CASE IH | 4760486 | A-4760486 |
| CASE IH | 84817624 | A-84817624 |
| CASE IH | 87300105 | A-87300105 |
| CASE IH | 87437226 | A-87437226 |



CASE IH

| OEM | OEM  Part No. | PIX  Part No. |
|---------|--|--|
| CASE IH | 87366407 | A-87366407 |
| CASE IH | 87840341 | A-87840341 |
| CASE IH | 87531428 | A-87531428 |
| CASE IH | 87441272 | A-87441272 |
| CASE IH | 87325327 | A-87325327 |
| CASE IH | A189040 | A-A189040 |
| CASE IH | 87301455 | A-87301455 |
| CASE IH | 244423A3 | A-244423A3 |
| CASE IH | 334065 | A-334065 |
| CASE IH | 603720 | A-603720 |
| CASE IH | 413159A1 | A-413159A1 |
| CASE IH | 274224 | A-274224 |
| CASE IH | 49341D | A-49341D |
| CASE IH | 55418 | A-55418 |
| CASE IH | 558141R1 | A-558141R1 |
| CASE IH | 700713435 | A-700713435 |
| CASE IH | 700714715 | A-700714715 |
| CASE IH | 829131C1 | A-829131C1 |
| CASE IH | A59762 | A-A59762 |
| CASE IH | A65717 | A-A65717 |
| CASE IH | 86627796 | A-86627796 |
| CASE IH | 87317063 | A-87317063 |
| CASE IH | 393750A1 | A-393750A1 |
| CASE IH | 84817625 | A-84817625 |
| CASE IH | 84817631 | A-84817631 |
| CASE IH | 84817634 | A-84817634 |
| CASE IH | 323646 | A-323646 |
| CASE IH | 356024 | A-356024 |
| CASE IH | 356025 | A-356025 |
| CASE IH | 387469 | A-387469 |
| CASE IH | 422731 | A-422731 |
| CASE IH | 424563 | A-424563 |
| CASE IH | 753053 | A-753053 |
| CASE IH | 31301147 | A-31301147 |
| CASE IH | 31318645 | A-31318645 |
| CASE IH | 80046914 | A-80046914 |
| CASE IH | 80913524 | A-80913524 |
| CASE IH | 84058255 | A-84058255 |
| CASE IH | 84074273 | A-84074273 |
| CASE IH | 87628477 | A-87628477 |
| CASE IH | 4131775313 | A-4131775313 |
| CASE IH | 4131781055 | A-4131781055 |
| CASE IH | 4240053761 | A-4240053761 |
| CASE IH | 4255643332 | A-4255643332 |
| CASE IH | 9911861524 | A-9911861524 |
| CASE IH | 9911861901 | A-9911861901 |



| OEM | OEM  Part No. | PIX  Part No. |
|---------|--|--|
| CASE IH | 9911862043 | A-9911862043 |
| CASE IH | 51102171670 | A-51102171670 |
| CASE IH | 51102174610 | A-51102174610 |
| CASE IH | 3129140R1 | A-3129140R1 |
| CASE IH | 86975809 | A-86975809 |
| CASE IH | 80396749 | A-80396749 |
| CASE IH | 84172256 | A-84172256 |
| CASE IH | 87283139 | A-87283139 |
| CASE IH | 87673234 | A-87673234 |
| CASE IH | 60206971 | A-060206971 |
| CASE IH | 61068968 | A-061068968 |
| CASE IH | 107671C1 | A-107671C1 |
| CASE IH | 131403C1 | A-131403C1 |
| CASE IH | 320344A1 | A-320344A1 |
| CASE IH | 52318DA | A-52318DA |
| CASE IH | A145325 | A-A145325 |
| CASE IH | A18426 | A-A18426 |
| CASE IH | A30585 | A-A30585 |
| CASE IH | A61048 | A-A61048 |
| CASE IH | A65143 | A-A65143 |
| CASE IH | A78022 | A-A78022 |
| CASE IH | 403617R1 | A-403617R1 |
| CASE IH | 244422A4 | A-244422A4 |
| CASE IH | 48032DA | A-48032DA |
| CASE IH | 86011009 | A-86011009 |
| CASE IH | 86013678 | A-86013678 |
| CASE IH | A22766 | A-A22766 |
| CASE IH | T38546 | A-T38546 |
| CASE IH | J911567 | A-J911567 |
| CASE IH | J911580 | A-J911580 |
| CASE IH | 439129 | A-439129 |
| CASE IH | 755808 | A-755808 |
| CASE IH | 9575059 | A-9575059 |
| CASE IH | 4031832698 | A-4031832698 |
| CASE IH | 4032804396 | A-4032804396 |
| CASE IH | 4032807784 | A-4032807784 |
| CASE IH | 4131775305 | A-4131775305 |
| CASE IH | 123306A1 | A-123306A1 |
| CASE IH | 16131DA | A-16131DA |
| CASE IH | 244420A4 | A-244420A4 |
| CASE IH | 244422A3 | A-244422A3 |
| CASE IH | J911557 | A-J911557 |
| CASE IH | K903050 | A-K903050 |
| CASE IH | 47131754 | A-47131754 |
| CASE IH | 87800858 | A-87800858 |
| CASE IH | J911561 | A-J911561 |
| CASE IH | 403348R1 | A-403348R1 |



CASE IH

| OEM | OEM  Part No. | PIX  Part No. |
|---------|--|--|
| CASE IH | 396830R1 | A-396830R1 |
| CASE IH | 385738R1 | A-385738R1 |
| CASE IH | 244423A1 | A-244423A1 |
| CASE IH | 193923C4 | A-193923C4 |
| CASE IH | 9604339 | A-9604339 |
| CASE IH | 87699094 | A-87699094 |
| CASE IH | K311714 | A-K311714 |
| CASE IH | 87402830 | A-87402830 |
| CASE IH | 87441267 | A-87441267 |
| CASE IH | 243373A1 | A-243373A1 |
| CASE IH | 48878D | A-48878D |
| CASE IH | 49291D | A-49291D |
| CASE IH | 237153R1 | A-237153R1 |
| CASE IH | 380060R1 | A-380060R1 |
| CASE IH | 60712D | A-60712D |
| CASE IH | 46869D | A-46869D |
| CASE IH | 532746R2 | A-532746R2 |
| CASE IH | 385120R2 | A-385120R2 |
| CASE IH | 534311R1 | A-534311R1 |
| CASE IH | 532030R2 | A-532030R2 |
| CASE IH | A135265 | A-A135265 |
| CASE IH | 80130C1 | A-80130C1 |
| CASE IH | 362828R1 | A-362828R1 |
| CASE IH | 68386C1 | A-68386C1 |
| CASE IH | 530076R1 | A-530076R1 |
| CASE IH | 367697R1 | A-367697R1 |
| CASE IH | 251428R1 | A-251428R1 |
| CASE IH | 434044 | A-434044 |
| CASE IH | 330715 | A-330715 |
| CASE IH | 230056 | A-230056 |
| CASE IH | 9911860435 | A-9911860435 |
| CASE IH | 230078 | A-230078 |
| CASE IH | 321559 | A-321559 |
| CASE IH | 230077 | A-230077 |
| CASE IH | 84078581 | A-84078581 |
| CASE IH | 1410094R1 | A-1410094R1 |
| CASE IH | 3157009R1 | A-3157009R1 |
| CASE IH | 3155127R1 | A-3155127R1 |
| CASE IH | 794464R2 | A-794464R2 |
| CASE IH | 446970 | A-446970 |
| CASE IH | 194528C2 | A-194528C2 |
| CASE IH | 325289A1 | A-325289A1 |
| CASE IH | 87747431 | A-87747431 |
| CASE IH | 87489502 | A-87489502 |
| CASE IH | 3228131R1 | A-3228131R1 |
| CASE IH | 3228279R1 | A-3228279R1 |
| CASE IH | 1319245C1 | A-1319245C1 |



| OEM | OEM  Part No. | PIX  Part No. |
|---------|--|--|
| CASE IH | 151529R2 | A-151529R2 |
| CASE IH | 23898K | A-23898K |
| CASE IH | 247430A1 | A-247430A1 |
| CASE IH | 319904A1 | A-319904A1 |
| CASE IH | 65337C2 | A-65337C2 |
| CASE IH | 829627C1 | A-829627C1 |
| CASE IH | 86582818 | A-86582818 |
| CASE IH | 86627791 | A-86627791 |
| CASE IH | 89817249 | A-89817249 |
| CASE IH | 937931R1 | A-937931R1 |
| CASE IH | A28129 | A-A28129 |
| CASE IH | A34820 | A-A34820 |
| CASE IH | 86514615 | A-86514615 |
| CASE IH | 86633896 | A-86633896 |
| CASE IH | 1315074C2 | A-1315074C2 |
| CASE IH | 1316573C2 | A-1316573C2 |
| CASE IH | 1336609C1 | A-1336609C1 |
| CASE IH | 333958 | A-333958 |
| CASE IH | 378989 | A-378989 |
| CASE IH | 86627810 | A-86627810 |
| CASE IH | R32782 | A-R32782 |
| CASE IH | 60206963 | A-060206963 |
| CASE IH | 61009396 | A-061009396 |
| CASE IH | 704449R1 | A-704449R1 |
| CASE IH | 84449662 | A-84449662 |
| CASE IH | 60067605 | A-60067605 |
| CASE IH | 447031 | A-447031 |
| CASE IH | 440780 | A-440780 |
| CASE IH | 84005861 | A-84005861 |
| CASE IH | 4895249 | A-4895249 |
| CASE IH | 87397416 | A-87397416 |
| CASE IH | 84023913 | A-84023913 |
| CASE IH | 31302076 | A-31302076 |
| CASE IH | 1170157 | A-1170157 |
| CASE IH | 87354138 | A-87354138 |
| CASE IH | 31275280N1 | A-31275280N1 |
| CASE IH | 3119750R1 | A-3119750R1 |
| CASE IH | K913631 | A-K913631 |
| CASE IH | 89831701 | A-89831701 |
| CASE IH | 89831704 | A-89831704 |
| CASE IH | 140100060001 | A-140100060001 |
| CASE IH | 130100060017 | A-130100060017 |
| CASE IH | 130100060018 | A-130100060018 |
| CASE IH | 84995734 | A-84995734 |
| CASE IH | 87373569 | A-87373569 |
| CASE IH | K308448 | A-K308448 |
| CASE IH | 1113936 | A-1113936 |



CASE IH

| OEM | OEM  Part No. | PIX  Part No. |
|---------|--|--|
| CASE IH | 238990A1 | A-238990A1 |
| CASE IH | 84817670 | A-84817670 |
| CASE IH | 84449518 | A-84449518 |
| CASE IH | 83949803 | A-83949803 |
| CASE IH | 754165 | A-754165 |
| CASE IH | 87354141 | A-87354141 |
| CASE IH | 81549846 | A-81549846 |
| CASE IH | 89831736 | A-89831736 |
| CASE IH | 89831738 | A-89831738 |
| CASE IH | 89831739 | A-89831739 |
| CASE IH | 81845565 | A-81845565 |
| CASE IH | 3218952R1 | A-3218952R1 |
| CASE IH | 89831749 | A-89831749 |
| CASE IH | 98490935 | A-98490935 |
| CASE IH | 397175R1 | A-397175R1 |
| CASE IH | 378113R2 | A-378113R2 |
| CASE IH | 385674R1 | A-385674R1 |
| CASE IH | 394013R1 | A-394013R1 |
| CASE IH | 132000130021 | A-132000130021 |
| CASE IH | 379966R2 | A-379966R2 |
| CASE IH | 140100130132 | A-140100130132 |
| CASE IH | 142000060001 | A-142000060001 |
| CASE IH | 142000060011 | A-142000060011 |
| CASE IH | 139900130003 | A-139900130003 |
| CASE IH | 142000060012 | A-142000060012 |
| CASE IH | 162000060005 | A-162000060005 |
| CASE IH | 59969C91 | A-59969C91 |
| CASE IH | 379629R1 | A-379629R1 |
| CASE IH | 162000130004 | A-162000130004 |
| CASE IH | 393519 | A-393519 |
| CASE IH | 500380059 | A-500380059 |
| CASE IH | 87802644 | A-87802644 |
| CASE IH | 82010895 | A-82010895 |
| CASE IH | 87802911 | A-87802911 |
| CASE IH | 82850750 | A-82850750 |
| CASE IH | 82850752 | A-82850752 |
| CASE IH | J911587 | A-J911587 |
| CASE IH | 87415774 | A-87415774 |
| CASE IH | 85826230 | A-85826230 |
| CASE IH | J925953 | A-J925953 |
| CASE IH | J911571 | A-J911571 |
| CASE IH | J911563 | A-J911563 |
| CASE IH | 4899178 | A-4899178 |
| CASE IH | J911573 | A-J911573 |
| CASE IH | J911559 | A-J911559 |
| CASE IH | J911566 | A-J911566 |
| CASE IH | J911564 | A-J911564 |



| OEM | OEM  Part No. | PIX  Part No. |
|---------|--|--|
| CASE IH | 2853208 | A-2853208 |
| CASE IH | 2856151 | A-2856151 |
| CASE IH | 437033 | A-437033 |
| CASE IH | 60500044 | A-60500044 |
| CASE IH | 340433153 | A-340433153 |
| CASE IH | 84073615 | A-84073615 |
| CASE IH | 86595191 | A-86595191 |
| CASE IH | 61067790 | A-61067790 |
| CASE IH | 80159837 | A-80159837 |
| CASE IH | 31317917 | A-31317917 |
| CASE IH | 913524 | A-913524 |
| CASE IH | 84026892 | A-84026892 |
| CASE IH | 87061270 | A-87061270 |
| CASE IH | 84026668 | A-84026668 |
| CASE IH | 87027209 | A-87027209 |
| CASE IH | 80746891 | A-80746891 |
| CASE IH | 84440188 | A-84440188 |
| CASE IH | 452864R1 | A-452864R1 |
| CASE IH | 790522R1 | A-790522R1 |
| CASE IH | 60187284 | A-60187284 |
| CASE IH | 214522C1 | A-214522C1 |
| CASE IH | 87393905 | A-87393905 |
| CASE IH | 1113501 | A-01113501 |
| CASE IH | 84041094 | A-84041094 |
| CASE IH | 86988710 | A-86988710 |
| CASE IH | 61036454 | A-61036454 |
| CASE IH | 89819509 | A-89819509 |
| CASE IH | 84996134 | A-84996134 |
| CASE IH | 31343437 | A-31343437 |
| CASE IH | 1101811 | A-1101811 |
| CASE IH | 60519150 | A-60519150 |
| CASE IH | 87368902 | A-87368902 |
| CASE IH | 84817637 | A-84817637 |
| CASE IH | 87628478 | A-87628478 |
| CASE IH | 84041095 | A-84041095 |
| CASE IH | 87346514 | A-87346514 |
| CASE IH | 1407123R1 | A-1407123R1 |
| CASE IH | 84054417 | A-84054417 |
| CASE IH | 61068935 | A-61068935 |
| CASE IH | 60068286 | A-60068286 |
| CASE IH | 9817374 | A-9817374 |
| CASE IH | 60067590 | A-60067590 |
| CASE IH | 393751A1 | A-393751A1 |
| CASE IH | 84459680 | A-84459680 |
| CASE IH | 84435248 | A-84435248 |
| CASE IH | 851792 | A-851792 |
| CASE IH | 1170011 | A-1170011 |



CASE IH

| OEM | OEM  Part No. | PIX  Part No. |
|---------|--|--|
| CASE IH | 9593464 | A-9593464 |
| CASE IH | 60124334 | A-60124334 |
| CASE IH | 743877 | A-743877 |
| CASE IH | 61068927 | A-61068927 |
| CASE IH | 61068943 | A-61068943 |
| CASE IH | 89516212 | A-89516212 |
| CASE IH | 84449232 | A-84449232 |
| CASE IH | 84448759 | A-84448759 |
| CASE IH | 84449861 | A-84449861 |
| CASE IH | 1169991 | A-1169991 |
| CASE IH | 1170116 | A-1170116 |
| CASE IH | 1170124 | A-1170124 |
| CASE IH | 3069379R1 | A-3069379R1 |
| CASE IH | 84045751 | A-84045751 |
| CASE IH | 427456 | A-427456 |
| CASE IH | 674965R1 | A-674965R1 |
| CASE IH | 756900 | A-756900 |
| CASE IH | 84817621 | A-84817621 |
| CASE IH | 450511 | A-450511 |
| CASE IH | 89505865 | A-89505865 |
| CASE IH | 61068976 | A-61068976 |
| CASE IH | 60067638 | A-60067638 |
| CASE IH | 1725666 | A-1725666 |
| CASE IH | 1590486 | A-1590486 |
| CASE IH | 60206988 | A-60206988 |
| CASE IH | 87531466 | A-87531466 |
| CASE IH | 1170060 | A-1170060 |
| CASE IH | 3129139R1 | A-3129139R1 |
| CASE IH | A184652 | A-A184652 |
| CASE IH | 228332A2 | A-228332A2 |
| CASE IH | 920019592 | A-920019592 |
| CASE IH | 401191R1 | A-401191R1 |
| CASE IH | 9818705 | A-9818705 |
| CASE IH | 1108520 | A-01108520 |
| CASE IH | 395539R1 | A-395539R1 |
| CASE IH | 1111725 | A-1111725 |
| CASE IH | 60187034 | A-60187034 |
| CASE IH | K912196 | A-K912196 |
| CASE IH | K68073 | A-K68073 |
| CASE IH | 80516776 | A-80516776 |
| CASE IH | P938712 | A-P938712 |
| CASE IH | 388280 | A-388280 |
| CASE IH | 465059 | A-465059 |
| CASE IH | 465058 | A-465058 |
| CASE IH | 72049753 | A-72049753 |
| CASE IH | 80446970 | A-80446970 |
| CASE IH | E128625 | A-E128625 |



| OEM | OEM  Part No. | PIX  Part No. |
|---------|--|--|
| CASE IH | 1111678 | A-1111678 |
| CASE IH | 61069036 | A-061069036 |
| CASE IH | 31310695 | A-31310695 |
| CASE IH | 700710498 | A-700710498 |
| CASE IH | 1546118C1 | A-1546118C1 |
| CASE IH | 1313094C1 | A-1313094C1 |
| CASE IH | 1338328C1 | A-1338328C1 |
| CASE IH | 87283315 | A-87283315 |
| CASE IH | 86517680 | A-86517680 |
| CASE IH | 87351975 | A-87351975 |
| CASE IH | 9800111 | A-9800111 |
| CASE IH | 1710326 | A-1710326 |
| CASE IH | 235414A1 | A-235414A1 |
| CASE IH | 857938 | A-857938 |
| CASE IH | 403580R1 | A-403580R1 |
| CASE IH | 527621R1 | A-527621R1 |
| CASE IH | 534310R1 | A-534310R1 |
| CASE IH | 401691R1 | A-401691R1 |
| CASE IH | 857029 | A-857029 |
| CASE IH | 403303R1 | A-403303R1 |
| CASE IH | 80754423 | A-80754423 |
| CASE IH | 89833888 | A-89833888 |
| CASE IH | 87441270 | A-87441270 |
| CASE IH | B506234 | A-B506234 |
| CASE IH | 86516699 | A-86516699 |
| CASE IH | 826761C1 | A-826761C1 |
| CASE IH | 830123C1 | A-830123C1 |
| CASE IH | 3136258R1 | A-3136258R1 |
| CASE IH | 171434C1 | A-171434C1 |
| CASE IH | 236161R2 | A-236161R2 |
| CASE IH | 830122C1 | A-830122C1 |
| CASE IH | 829921C1 | A-829921C1 |
| CASE IH | 6-1428 | A-6-1428 |
| CASE IH | 315969R1 | A-315969R1 |
| CASE IH | 352095C1 | A-352095C1 |
| CASE IH | 274705R1 | A-274705R1 |
| CASE IH | 401128R2 | A-401128R2 |
| CASE IH | 1607227C1 | A-1607227C1 |
| CASE IH | 530186R1 | A-530186R1 |
| CASE IH | 172230C1 | A-172230C1 |
| CASE IH | 171994C1 | A-171994C1 |
| CASE IH | 196370C1 | A-196370C1 |
| CASE IH | 656349R1 | A-656349R1 |
| CASE IH | 178763C1 | A-178763C1 |
| CASE IH | 187415C2 | A-187415C2 |
| CASE IH | 184796C1 | A-184796C1 |
| CASE IH | 666390R1 | A-666390R1 |



CASE IH

| OEM | OEM  Part No. | PIX  Part No. |
|---------|--|--|
| CASE IH | 550950R1 | A-550950R1 |
| CASE IH | 673685R1 | A-673685R1 |
| CASE IH | 552747R2 | A-552747R2 |
| CASE IH | 672974R2 | A-672974R2 |
| CASE IH | 665970R1 | A-665970R1 |
| CASE IH | 488082R2 | A-488082R2 |
| CASE IH | 413159A2 | A-413159A2 |
| CASE IH | 674620R1 | A-674620R1 |
| CASE IH | 1979149C1 | A-1979149C1 |
| CASE IH | 277448R1 | A-277448R1 |
| CASE IH | 243372A1 | A-243372A1 |
| CASE IH | A169970 | A-A169970 |
| CASE IH | 3055715R1 | A-3055715R1 |
| CASE IH | 4270717737 | A-4270717737 |
| CASE IH | H938752 | A-H938752 |
| CASE IH | 3143002 | A-3143002 |
| CASE IH | W938719 | A-W938719 |
| CASE IH | 3050382R1 | A-3050382R1 |
| CASE IH | 716404R1 | A-716404R1 |
| CASE IH | 3142286 | A-3142286 |
| CASE IH | 190003142290 | A-190003142290 |
| CASE IH | 190003142304 | A-190003142304 |
| CASE IH | 3142287 | A-3142287 |
| CASE IH | 1609B130009 | A-1609B130009 |
| CASE IH | M138747 | A-M138747 |
| CASE IH | 3068879R1 | A-3068879R1 |
| CASE IH | T38726 | A-T38726 |
| CASE IH | Q938736 | A-Q938736 |
| CASE IH | 303416R1 | A-303416R1 |
| CASE IH | 3136257R1 | A-3136257R1 |
| CASE IH | 1413C060017 | A-1413C060017 |
| CASE IH | 3060802R2 | A-3060802R2 |
| CASE IH | 3136663R1 | A-3136663R1 |
| CASE IH | 3055526R1 | A-3055526R1 |
| CASE IH | 3218802R1 | A-3218802R1 |
| CASE IH | S438718 | A-S438718 |
| CASE IH | MGP1112 | A-MGP1112 |
| CASE IH | 758866R1 | A-758866R1 |
| CASE IH | 712216R1 | A-712216R1 |
| CASE IH | 714241R1 | A-714241R1 |
| CASE IH | 764956R1 | A-764956R1 |
| CASE IH | K38718 | A-K38718 |
| CASE IH | 51651131427 | A-51651131427 |
| CASE IH | R138705 | A-R138705 |
| CASE IH | 51652131450 | A-51652131450 |
| CASE IH | 3171057R2 | A-3171057R2 |
| CASE IH | 9514310 | A-9514310 |



| OEM | OEM  Part No. | PIX  Part No. |
|---------|--|--|
| CASE IH | 51651132765 | A-51651132765 |
| CASE IH | 457643 | A-457643 |
| CASE IH | 89509459 | A-89509459 |
| CASE IH | 358213R1 | A-358213R1 |
| CASE IH | 756232R1 | A-756232R1 |
| CASE IH | 84024926 | A-84024926 |
| CASE IH | Q938713 | A-Q938713 |
| CASE IH | J38717 | A-J38717 |
| CASE IH | P138703 | A-P138703 |
| CASE IH | 51652171372 | A-51652171372 |
| CASE IH | G38715 | A-G38715 |
| CASE IH | 1979606C2 | A-1979606C2 |
| CASE IH | 3172232R1 | A-3172232R1 |
| CASE IH | B506236 | A-B506236 |
| CASE IH | 51651171700 | A-51651171700 |
| CASE IH | 61521R1 | A-61521R1 |
| CASE IH | B506238 | A-B506238 |
| CASE IH | 51651171930 | A-51651171930 |
| CASE IH | 3175457R1 | A-3175457R1 |
| CASE IH | 3781694 | A-3781694 |
| CASE IH | 89510091 | A-89510091 |
| CASE IH | 89507997 | A-89507997 |
| CASE IH | 89515713 | A-89515713 |
| CASE IH | 1145629 | A-01145629 |
| CASE IH | 80749145 | A-80749145 |
| CASE IH | B506239 | A-B506239 |
| CASE IH | 51651172413 | A-51651172413 |
| CASE IH | 3172404R1 | A-3172404R1 |
| CASE IH | 84045444 | A-84045444 |
| CASE IH | 419375000 | A-419375000 |
| CASE IH | B506237 | A-B506237 |
| CASE IH | Nd9674 | A-ND-9674 |
| CASE IH | 1407035R1 | A-1407035R1 |
| CASE IH | 3157739R1 | A-3157739R1 |
| CASE IH | 1408761R1 | A-1408761R1 |
| CASE IH | 51651173861 | A-51651173861 |
| CASE IH | 31275207N1 | A-31275207N1 |
| CASE IH | 89813594 | A-89813594 |
| CASE IH | 58622R1 | A-58622R1 |
| CASE IH | 80449701 | A-80449701 |
| CASE IH | 756237R1 | A-756237R1 |
| CASE IH | 769543R91 | A-769543R91 |
| CASE IH | 51651170965 | A-51651170965 |
| CASE IH | 51651170975 | A-51651170975 |
| CASE IH | 69490DA | A-69490DA |
| CASE IH | 662213R1 | A-662213R1 |
| CASE IH | 89515167 | A-89515167 |



CASE IH

| OEM | OEM  Part No. | PIX  Part No. |
|---------|--|--|
| CASE IH | 89515172 | A-89515172 |
| CASE IH | N38744 | A-N38744 |
| CASE IH | 80749144 | A-80749144 |
| CASE IH | K138722 | A-K138722 |
| CASE IH | L38742 | A-L38742 |
| CASE IH | P38745 | A-P38745 |
| CASE IH | 9837412 | A-9837412 |
| CASE IH | 51651221981 | A-51651221981 |
| CASE IH | 3167489R1 | A-3167489R1 |
| CASE IH | 80531558 | A-80531558 |
| CASE IH | 80727852 | A-80727852 |
| CASE IH | 9911860628 | A-9911860628 |
| CASE IH | 51651222413 | A-51651222413 |
| CASE IH | 178019R1 | A-178019R1 |
| CASE IH | 1970116C2 | A-1970116C2 |
| CASE IH | 4264715364 | A-4264715364 |
| CASE IH | 3167361R2 | A-3167361R2 |
| CASE IH | 51651222650 | A-51651222650 |
| CASE IH | 51651222800 | A-51651222800 |
| CASE IH | 616355 | A-616355 |
| CASE IH | 1410279R1 | A-1410279R1 |
| CASE IH | 9819676 | A-9819676 |
| CASE IH | 84045959 | A-84045959 |
| CASE IH | 3175336R1 | A-3175336R1 |
| CASE IH | 3170210R1 | A-3170210R1 |
| CASE IH | B506235 | A-B506235 |
| CASE IH | 769830R2 | A-769830R2 |
| CASE IH | 3795185 | A-3795185 |
| CASE IH | 3157994R1 | A-3157994R1 |
| CASE IH | 84045018 | A-84045018 |
| CASE IH | 51651223505 | A-51651223505 |
| CASE IH | 3173717R1 | A-3173717R1 |
| CASE IH | 89835010 | A-89835010 |
| CASE IH | 989271C1 | A-989271C1 |
| CASE IH | 98927C | A-98927C |
| CASE IH | 80746889 | A-80746889 |
| CASE IH | 3173164R1 | A-3173164R1 |
| CASE IH | 793417R2 | A-793417R2 |
| CASE IH | 182819C1 | A-182819C1 |
| CASE IH | 1325050C1 | A-1325050C1 |
| CASE IH | 3155178R1 | A-3155178R1 |
| CASE IH | 3167797R1 | A-3167797R1 |
| CASE IH | 9839375 | A-9839375 |
| CASE IH | 921330 | A-921330 |
| CASE IH | 9593418 | A-9593418 |
| CASE IH | 9593440 | A-9593440 |
| CASE IH | 84005971 | A-84005971 |



| OEM | OEM  Part No. | PIX  Part No. |
|---------|--|--|
| CASE IH | 89835047 | A-89835047 |
| CASE IH | 84005972 | A-84005972 |
| CASE IH | 84019385 | A-84019385 |
| CASE IH | 4221613143 | A-4221613143 |
| CASE IH | 3158455R1 | A-3158455R1 |
| CASE IH | 3173480R1 | A-3173480R1 |
| CASE IH | 3173115R1 | A-3173115R1 |
| CASE IH | 51651255246 | A-51651255246 |
| CASE IH | 51101256000 | A-51101256000 |
| CASE IH | 3175036R2 | A-3175036R2 |
| CASE IH | 793051R2 | A-793051R2 |
| CASE IH | 9502828 | A-9502828 |
| CASE IH | 9814069 | A-9814069 |
| CASE IH | 51652171800 | A-51652171800 |
| CASE IH | 51652172200 | A-51652172200 |
| CASE IH | 51652172500 | A-51652172500 |
| CASE IH | 770000722 | A-770000722 |
| CASE IH | 9351.0174.00 | A-9351.0174.00 |
| CASE IH | 4270722236 | A-4270722236 |
| CASE IH | 51652174225 | A-51652174225 |
| CASE IH | 51652174350 | A-51652174350 |
| CASE IH | 51652175000 | A-51652175000 |
| CASE IH | 89811480 | A-89811480 |
| CASE IH | 89819506 | A-89819506 |
| CASE IH | 89811963 | A-89811963 |
| CASE IH | 89819507 | A-89819507 |
| CASE IH | 904029 | A-904029 |
| CASE IH | 770002330 | A-770002330 |
| CASE IH | 904031 | A-904031 |
| CASE IH | 904038 | A-904038 |
| CASE IH | 904027 | A-904027 |
| CASE IH | 9351.0274.00 | A-9351.0274.00 |
| CASE IH | 3167149R1 | A-3167149R1 |
| CASE IH | 84007006 | A-84007006 |
| CASE IH | 1113096X1 | A-1113096X1 |
| CASE IH | 9835120 | A-9835120 |
| CASE IH | 84007677 | A-84007677 |
| CASE IH | 1410106R1 | A-1410106R1 |
| CASE IH | 1410462R1 | A-1410462R1 |
| CASE IH | 3157094R1 | A-3157094R1 |
| CASE IH | 3157738R2 | A-3157738R2 |
| CASE IH | 3157741R1 | A-3157741R1 |
| CASE IH | 797475 | A-797475 |
| CASE IH | 51653173180 | A-51653173180 |
| CASE IH | 31295188 | A-31295188 |
| CASE IH | 51653173762 | A-51653173762 |
| CASE IH | 3175078R1 | A-3175078R1 |



CASE IH

| OEM | OEM  Part No. | PIX  Part No. |
|---------|--|--|
| CASE IH | 3173726R1 | A-3173726R1 |
| CASE IH | 1113097C2 | A-1113097C2 |
| CASE IH | 80851792 | A-80851792 |
| CASE IH | 84814035 | A-84814035 |
| CASE IH | 80392361 | A-80392361 |
| CASE IH | 3167653R2 | A-3167653R2 |
| CASE IH | 84012390 | A-84012390 |
| CASE IH | 9593400 | A-9593400 |
| CASE IH | 4250121885 | A-4250121885 |
| CASE IH | 8602680 | A-8602680 |
| CASE IH | 87802822 | A-87802822 |
| CASE IH | 87441268 | A-87441268 |
| CASE IH | 87403145 | A-87403145 |
| CASE IH | 31314408 | A-31314408 |
| CASE IH | 87403144 | A-87403144 |
| CASE IH | 9835683 | A-9835683 |
| CASE IH | 84215838 | A-84215838 |
| CASE IH | 84075677 | A-84075677 |
| CASE IH | 716415R1 | A-716415R1 |
| CASE IH | 716417R1 | A-716417R1 |
| CASE IH | 89831693 | A-89831693 |
| CASE IH | 89831694 | A-89831694 |
| CASE IH | 89831696 | A-89831696 |
| CASE IH | 89831697 | A-89831697 |
| CASE IH | 89831698 | A-89831698 |
| CASE IH | 89831699 | A-89831699 |
| CASE IH | 89831700 | A-89831700 |
| CASE IH | 89831703 | A-89831703 |
| CASE IH | 89831705 | A-89831705 |
| CASE IH | 89831706 | A-89831706 |
| CASE IH | 89831707 | A-89831707 |
| CASE IH | 89831708 | A-89831708 |
| CASE IH | 89831709 | A-89831709 |
| CASE IH | 89831710 | A-89831710 |
| CASE IH | 89831711 | A-89831711 |
| CASE IH | 89831712 | A-89831712 |
| CASE IH | 89831713 | A-89831713 |
| CASE IH | 89831714 | A-89831714 |
| CASE IH | 89831715 | A-89831715 |
| CASE IH | 89831716 | A-89831716 |
| CASE IH | 89831717 | A-89831717 |
| CASE IH | 89831718 | A-89831718 |
| CASE IH | 89831719 | A-89831719 |
| CASE IH | 89831720 | A-89831720 |
| CASE IH | 89831721 | A-89831721 |
| CASE IH | 14010060002 | A-14010060002 |
| CASE IH | 299659A1 | A-299659A1 |



| OEM | OEM  Part No. | PIX  Part No. |
|---------|--|--|
| CASE IH | A938768 | A-A938768 |
| CASE IH | B938746 | A-B938746 |
| CASE IH | C338723 | A-C338723 |
| CASE IH | E84994 | A-E84994 |
| CASE IH | S938738 | A-S938738 |
| CASE IH | T938762 | A-T938762 |
| CASE IH | U938740 | A-U938740 |
| CASE IH | V938741 | A-V938741 |
| CASE IH | V938764 | A-V938764 |
| CASE IH | W938742 | A-W938742 |
| CASE IH | X938743 | A-X938743 |
| CASE IH | 80452023 | A-80452023 |
| CASE IH | 3228287R91 | A-3228287R91 |
| CASE IH | 130013 | A-130013 |
| CASE IH | 381236 | A-381236 |
| CASE IH | 748003 | A-748003 |
| CASE IH | 6500261 | A-6500261 |
| CASE IH | 9508557 | A-9508557 |
| CASE IH | 9835815 | A-9835815 |
| CASE IH | 87366024 | A-87366024 |
| CASE IH | 89831722 | A-89831722 |
| CASE IH | 89831723 | A-89831723 |
| CASE IH | 89831724 | A-89831724 |
| CASE IH | 89831725 | A-89831725 |
| CASE IH | 89831726 | A-89831726 |
| CASE IH | 89831727 | A-89831727 |
| CASE IH | 89831728 | A-89831728 |
| CASE IH | 89831730 | A-89831730 |
| CASE IH | 89831732 | A-89831732 |
| CASE IH | 89831734 | A-89831734 |
| CASE IH | 89831743 | A-89831743 |
| CASE IH | 89831744 | A-89831744 |
| CASE IH | 89831745 | A-89831745 |
| CASE IH | 89831746 | A-89831746 |
| CASE IH | 89831747 | A-89831747 |
| CASE IH | 89831748 | A-89831748 |
| CASE IH | 89831750 | A-89831750 |
| CASE IH | 89831751 | A-89831751 |
| CASE IH | 89831752 | A-89831752 |
| CASE IH | 082.383/28 | A-082.383/28 |
| CASE IH | 082.383/42 | A-082.383/42 |
| CASE IH | 162000060007(1) | A-162000060007(1) |
| CASE IH | 3043167R1 | A-3043167R1 |
| CASE IH | 3055715R91 | A-3055715R91 |
| CASE IH | 3068901R1 | A-3068901R1 |
| CASE IH | 3136421R1 | A-3136421R1 |
| CASE IH | 3139157R91 | A-3139157R91 |



CASE IH

| OEM | OEM  Part No. | PIX  Part No. |
|---------|--|--|
| CASE IH | 3144098R91 | A-3144098R91 |
| CASE IH | 3144678R1 | A-3144678R1 |
| CASE IH | 3218043R1 | A-3218043R1 |
| CASE IH | 3218951R1 | A-3218951R1 |
| CASE IH | 3228274R1 | A-3228274R1 |
| CASE IH | 3228282R1 | A-3228282R1 |
| CASE IH | 3228287R1 | A-3228287R1 |
| CASE IH | 3228641R1 | A-3228641R1 |
| CASE IH | 3522468M3 | A-3522468M3 |
| CASE IH | 6102366M1 | A-6102366M1 |
| CASE IH | 84766X1 | A-84766X1 |
| CASE IH | 3172275R1 | A-3172275R1 |
| CASE IH | 3176321R1 | A-3176321R1 |
| CASE IH | 1408840R1 | A-1408840R1 |
| CASE IH | 3158811R1 | A-3158811R1 |
| CASE IH | 3157600R1 | A-3157600R1 |
| CASE IH | 181055C11 | A-181055C11 |
| CASE IH | B506233 | A-B506233 |
| CASE IH | Q138796 | A-Q138796 |
| CASE IH | R138797 | A-R138797 |
| CASE IH | N938757 | A-N938757 |
| CASE IH | 9911861477 | A-9911861477 |
| CASE IH | 9911861918 | A-9911861918 |
| CASE IH | Nd9240 | A-ND9240 |
| CASE IH | 768220R91 | A-768220R91 |
| CASE IH | 767585R91 | A-767585R91 |
| CASE IH | R938760 | A-R938760 |
| CASE IH | C938770 | A-C938770 |
| CASE IH | Nd9036 | A-ND-9036 |
| CASE IH | 3175578R1 | A-3175578R1 |
| CASE IH | Nd9073 | A-ND-9073 |
| CASE IH | Nd9050 | A-ND9050 |
| CASE IH | Ap706228207 | A-AP706228207 |
| CASE IH | 3176558R1 | A-3176558R1 |
| CASE IH | 769482R1 | A-769482R1 |
| CASE IH | 9911861717 | A-9911861717 |
| CASE IH | 89515166 | A-89515166 |
| CASE IH | 209553078 | A-209553078 |
| CASE IH | 9911861493 | A-9911861493 |
| CASE IH | H938775 | A-H938775 |
| CASE IH | K938731 | A-K938731 |
| CASE IH | 80543226 | A-80543226 |
| CASE IH | 80565498 | A-80565498 |
| CASE IH | 89513440 | A-89513440 |
| CASE IH | 89850532 | A-89850532 |
| CASE IH | 9911861612 | A-9911861612 |
| CASE IH | ND9471 | A-ND-9471 |



| OEM | OEM  Part No. | PIX  Part No. |
|---------|--|--|
| CASE IH | Nd9359 | A-ND-9359 |
| CASE IH | Nd9092 | A-ND-9092 |
| CASE IH | 31360374 | A-31360374 |
| CASE IH | 9911861516 | A-9911861516 |
| CASE IH | 4131781578 | A-4131781578 |
| CASE IH | 9911861540 | A-9911861540 |
| CASE IH | 9911861862 | A-9911861862 |
| CASE IH | 9911861926 | A-9911861926 |
| CASE IH | 762861R1 | A-762861R1 |
| CASE IH | A138759 | A-A138759 |
| CASE IH | G138788 | A-G138788 |
| CASE IH | 31302068 | A-31302068 |
| CASE IH | 6100645M1 | A-6100645M1 |
| CASE IH | 288648A1 | A-288648A1 |
| CASE IH | 683548C91 | A-683548C91 |
| CASE IH | 760285R1 | A-760285R1 |
| CASE IH | 3061786R2 | A-3061786R2 |
| CASE IH | 80603720 | A-80603720 |
| CASE IH | 51651321480 | A-51651321480 |
| CASE IH | 3155068R1 | A-3155068R1 |
| CASE IH | 3156215R1 | A-3156215R1 |
| CASE IH | 3158242R1 | A-3158242R1 |
| CASE IH | 446969 | A-446969 |
| CASE IH | 80446969 | A-80446969 |
| CASE IH | 51651453200 | A-51651453200 |
| CASE IH | 314115 | A-314115 |
| CASE IH | 3175110R1 | A-3175110R1 |
| CASE IH | 51651502130 | A-51651502130 |
| CASE IH | 4270722244 | A-4270722244 |
| CASE IH | 244420A3 | A-244420A3 |
| CASE IH | 4254138496 | A-4254138496 |
| CASE IH | S938761 | A-S938761 |
| CASE IH | 1966513C1 | A-1966513C1 |
| CASE IH | 9833888 | A-9833888 |
| CASE IH | N938734 | A-N938734 |
| CASE IH | 4102/50063 | A-4102/50063 |
| CASE IH | A34359 | A-A34359 |
| CASE IH | 907190T1 | A-90-7190T1 |
| CASE IH | A75577 | A-A75577 |
| CASE IH | 903806T1 | A-90-3806T1 |
| CASE IH | A76758 | A-A76758 |
| CASE IH | 901375T1 | A-90-1375T1 |
| CASE IH | A138760 | A-A138760 |
| CASE IH | A164473 | A-A164473 |
| CASE IH | A164474 | A-A164474 |
| CASE IH | A65716 | A-A65716 |
| CASE-IH | 937806R1 | A-937806R1 |



CASE IH

| OEM | OEM  Part No. | PIX  Part No. |
|---------|--|--|
| CASE IH | A57123 | A-A57123 |
| CASE IH | 903861T1 | A-90-3861T1 |
| CASE IH | A57130 | A-A57130 |
| CASE IH | A76745 | A-A76745 |
| CASE IH | 903807T1 | A-90-3807T1 |
| CASE IH | 1285320C1 | A-1285320C1 |
| CASE IH | 1546117C2 | A-1546117C2 |
| CASE IH | 700707578 | A-700707578 |
| CASE IH | 1260258C2 | A-1260258C2 |
| CASE IH | 167031C2 | A-167031C2 |
| CASE IH | 131303C91 | A-131303C91 |
| CASE IH | 13988K | A-13988K |
| CASE IH | 161820C1 | A-161820C1 |
| CASE IH | 1315169C1 | A-1315169C1 |
| CASE IH | 165676C1 | A-165676C1 |
| CASE IH | 98041408 | A-98-041408 |
| CASE IH | 98028535 | A-98-028535 |
| CASE IH | 98029076 | A-98-029076 |
| CASE IH | 98031256 | A-98-031256 |
| CASE IH | 98039778 | A-98-039778 |
| CASE IH | 1113985 | A-1113985 |
| CASE IH | 10VX00C | A-10VX00C |
| CASE IH | 247426A1 | A-247426A1 |
| CASE IH | 98039776 | A-98-039776 |
| CASE IH | 84299873 | A-84299873 |
| CASE IH | 73180336 | A-73180336 |
| CASE IH | 84021589 | A-84021589 |
| CASE IH | 50404925 | A-50404925 |
| CASE IH | 87518813 | A-87518813 |
| CASE IH | 294462A1 | A-294462A1 |
| CASE IH | 87656225 | A-87656225 |
| CASE IH | 87641387 | A-87641387 |
| CASE IH | 84026762 | A-84026762 |
| CASE IH | 86514512 | A-86514512 |
| CASE IH | 87758085 | A-87758085 |
| CASE IH | 47406268 | A-47406268 |
| CASE IH | 84455765 | A-84455765 |
| CASE IH | 600P09 | A-600P09 |
| CASE IH | 600P05 | A-600P05 |
| CASE IH | 87739437 | A-87739437 |
| CASE IH | 86514520 | A-86514520 |
| CASE IH | 677419 | A-677419 |
| CASE IH | 87683178 | A-87683178 |
| CASE IH | 861731 | A-861731 |
| CASE IH | 87572660 | A-87572660 |
| CASE IH | 84056914 | A-84056914 |
| CASE IH | 84455758 | A-84455758 |



| OEM | OEM  Part No. | PIX  Part No. |
|---------|--|--|
| CASE IH | 84455766 | A-84455766 |
| CASE IH | 709998 | A-709998 |
| CASE IH | 904034 | A-904034 |
| CASE IH | 86629764 | A-86629764 |
| CASE IH | 84043107 | A-84043107 |
| CASE IH | 84057610 | A-84057610 |
| CASE IH | 84075053 | A-84075053 |
| CASE IH | 159837 | A-159837 |
| CASE IH | 84452723 | A-84452723 |
| CASE IH | 84452979 | A-84452979 |
| CASE IH | 80453267 | A-80453267 |
| CASE IH | 84180490 | A-84180490 |
| CASE IH | 516776 | A-516776 |
| CASE IH | 904035 | A-904035 |
| CASE IH | 47413433 | A-47413433 |
| CASE IH | 433747 | A-433747 |
| CASE IH | 80433747 | A-80433747 |
| CASE IH | 600J04 | A-600J04 |
| CASE IH | 600J06 | A-600J06 |
| CASE IH | 326298 | A-326298 |
| CASE IH | 600A10 | A-600A10 |
| CASE IH | 186347 | A-186347 |
| CASE IH | 84320459 | A-84320459 |
| CASE IH | 84226318 | A-84226318 |
| CASE IH | 47419045 | A-47419045 |
| CASE IH | 188213C3 | A-188213C3 |
| CASE IH | 600J09 | A-600J09 |
| CASE IH | 80347469 | A-80347469 |
| CASE IH | 84256364 | A-84256364 |
| CASE IH | 9351.0039.00 | A-9351.0039.00 |
| CASE IH | 87528805 | A-87528805 |
| CASE IH | 9351.0047.00 | A-9351.0047.00 |
| CASE IH | 600A12 | A-600A12 |
| CASE IH | 600A77 | A-600A77 |
| CASE IH | 9351.0055.00 | A-9351.0055.00 |
| CASE IH | 600A06 | A-600A06 |
| CASE IH | 600A715 | A-600A715 |
| CASE IH | 600A701 | A-600A701 |
| CASE IH | 84139175 | A-84139175 |
| CASE IH | 84411381 | A-84411381 |
| CASE IH | 84513766 | A-84513766 |
| CASE IH | 84284322 | A-84284322 |
| CASE IH | 8520042 | A-8520042 |
| CASE IH | 84376536 | A-84376536 |
| CASE IH | 904009 | A-904009 |
| CASE IH | 87564452 | A-87564452 |
| CASE IH | 87564549 | A-87564549 |



CASE IH

| OEM | OEM  Part No. | PIX  Part No. |
|---------|--|--|
| CASE IH | 84171789 | A-84171789 |
| CASE IH | 84256369 | A-84256369 |
| CASE IH | 904011 | A-904011 |
| CASE IH | 9351017400 | A-9351017400 |
| CASE IH | 717699 | A-717699 |
| CASE IH | 84311543 | A-84311543 |
| CASE IH | 84533502 | A-84533502 |
| CASE IH | 9351.0179.00 | A-9351.0179.00 |
| CASE IH | 84287970 | A-84287970 |
| CASE IH | 84381274 | A-84381274 |
| CASE IH | 84286835 | A-84286835 |
| CASE IH | 84284468 | A-84284468 |
| CASE IH | 87664231 | A-87664231 |
| CASE IH | 746894 | A-746894 |
| CASE IH | E020T12 | A-E020T12 |
| CASE IH | 1170140 | A-1170140 |
| CASE IH | 87671748 | A-87671748 |
| CASE IH | 1114576 | A-01114576 |
| CASE IH | 770001008 | A-770001008 |
| CASE IH | 1114568 | A-01114568 |
| CASE IH | 84191907 | A-84191907 |
| CASE IH | 84192753 | A-84192753 |
| CASE IH | 20471086 | A-20471086 |
| CASE IH | 767564R1 | A-767564R1 |
| CASE IH | 1113390 | A-1113390 |
| CASE IH | 1170044 | A-01170044 |
| CASE IH | 47439480 | A-47439480 |
| CASE IH | 84254495 | A-84254495 |
| CASE IH | 47434574 | A-47434574 |
| CASE IH | 84514757 | A-84514757 |
| CASE IH | 87491779 | A-87491779 |
| CASE IH | 84582506 | A-84582506 |
| CASE IH | 60203060 | A-060203060 |
| CASE IH | 47415905 | A-47415905 |
| CASE IH | 60186515 | A-060186515 |
| CASE IH | 20797305 | A-20797305 |
| CASE IH | 60038063 | A-60038063 |
| CASE IH | 60520763 | A-60520763 |
| CASE IH | 770000980 | A-770000980 |
| CASE IH | 84298887 | A-84298887 |
| CASE IH | 47441074 | A-47441074 |
| CASE IH | E040T09 | A-E040T09 |
| CASE IH | 84036578 | A-84036578 |
| CASE IH | 84017753 | A-84017753 |
| CASE IH | 1114295 | A-01114295 |
| CASE IH | 9911860958 | A-9911860958 |
| CASE IH | 86627809 | A-86627809 |



| OEM | OEM  Part No. | PIX  Part No. |
|---------|--|--|
| CASE IH | 1169428 | A-1169428 |
| CASE IH | 86627808 | A-86627808 |
| CASE IH | 84012562 | A-84012562 |
| CASE IH | 87030923 | A-87030923 |
| CASE IH | 87012453 | A-87012453 |
| CASE IH | 84262973 | A-84262973 |
| CASE IH | 1170028 | A-1170028 |
| CASE IH | 61063633 | A-061063633 |
| CASE IH | 84582509 | A-84582509 |
| CASE IH | 87671939 | A-87671939 |
| CASE IH | 84356659 | A-84356659 |
| CASE IH | 84127377 | A-84127377 |
| CASE IH | 84223612 | A-84223612 |
| CASE IH | 84518497 | A-84518497 |
| CASE IH | 84531713 | A-84531713 |
| CASE IH | 84305213 | A-84305213 |
| CASE IH | S619146 | A-S619146 |
| CASE IH | 20797483 | A-20797483 |
| CASE IH | 4221668181 | A-4221668181 |
| CASE IH | 20797491 | A-20797491 |
| CASE IH | 1112638 | A-1112638 |
| CASE IH | 851791 | A-851791 |
| CASE IH | 4990/20555 | A-4990/20555 |
| CASE IH | 72023391 | A-72023391 |
| CASE IH | 1170036 | A-1170036 |
| CASE IH | 1169983 | A-1169983 |
| CASE IH | 84148387 | A-84148387 |
| CASE IH | 47414501 | A-47414501 |
| CASE IH | 1113831 | A-1113831 |
| CASE IH | 84449233 | A-84449233 |
| CASE IH | 84511734 | A-84511734 |
| CASE IH | 84296393 | A-84296393 |
| CASE IH | 87656270 | A-87656270 |
| CASE IH | 1170204 | A-01170204 |
| CASE IH | 1170003 | A-1170003 |
| CASE IH | 72048753 | A-72048753 |
| CASE IH | 1170181 | A-01170181 |
| CASE IH | 84458482 | A-84458482 |
| CASE IH | 84397971 | A-84397971 |
| CASE IH | 87472997 | A-87472997 |
| CASE IH | 87705737 | A-87705737 |
| CASE IH | 84413724 | A-84413724 |
| CASE IH | 3288757 | A-3288757 |
| CASE IH | 3288768 | A-3288768 |
| CASE IH | 82989326 | A-82989326 |
| CASE IH | 84412878 | A-84412878 |
| CASE IH | 3288812 | A-3288812 |



CASE IH

| OEM | OEM  Part No. | PIX  Part No. |
|---------|--|--|
| CASE IH | 86982450 | A-86982450 |
| CASE IH | 87630521 | A-87630521 |
| CASE IH | 82989350 | A-82989350 |
| CASE IH | 3288922 | A-3288922 |
| CASE IH | 84127292 | A-84127292 |
| CASE IH | 3288999 | A-3288999 |
| CASE IH | 2855970 | A-2855970 |
| CASE IH | 3289078 | A-3289078 |
| CASE IH | 86974844 | A-86974844 |
| CASE IH | 3972386 | A-3972386 |
| CASE IH | 3289224 | A-3289224 |
| CASE IH | 3289279 | A-3289279 |
| CASE IH | 84590653 | A-84590653 |
| CASE IH | 873541380 | A-873541380 |
| CASE IH | 84346830 | A-84346830 |
| CASE IH | 3289481 | A-3289481 |
| CASE IH | 3289593 | A-3289593 |
| CASE IH | 3289604 | A-3289604 |
| CASE IH | 87519458 | A-87519458 |
| CASE IH | 3289648 | A-3289648 |
| CASE IH | 84257945 | A-84257945 |
| CASE IH | 87357455 | A-87357455 |
| CASE IH | 3288867 | A-3288867 |
| CASE IH | 3290158 | A-3290158 |
| CASE IH | 3289768 | A-3289768 |
| CASE IH | 84373502 | A-84373502 |
| CASE IH | 842373502 | A-842373502 |
| CASE IH | 835683 | A-835683 |
| CASE IH | 84423385 | A-84423385 |
| CASE IH | 504380539 | A-504380539 |
| CASE IH | 2976405 | A-2976405 |
| CASE IH | Br11018 | A-BR11018 |
| CASE IH | 219498 | A-219498 |
| CASE IH | 270174 | A-270174 |
| CASE IH | 142273 | A-142273 |
| CASE IH | 84457069 | A-84457069 |
| CASE IH | 875556830 | A-875556830 |
| CASE IH | 178623 | A-178623 |
| CASE IH | 51400100 | A-51400100 |
| CASE IH | 5095203 | A-5095203 |
| CASE IH | 80443635 | A-80443635 |
| CASE IH | 87643267 | A-87643267 |
| CASE IH | 5088081 | A-5088081 |
| CASE IH | 60010 | A-60010 |
| CASE IH | 600101 | A-600101 |
| CASE IH | 3140085 | A-3140085 |
| CASE IH | 600021 | A-600021 |



| OEM | OEM  Part No. | PIX  Part No. |
|---------|--|--|
| CASE IH | 21486 | A-21486 |
| CASE IH | 5186233 | A-5186233 |
| CASE IH | 84243629 | A-84243629 |
| CASE IH | 47408557 | A-47408557 |
| CASE IH | 2929681 | A-2929681 |
| CASE IH | 873735690 | A-873735690 |
| CASE IH | 602211 | A-602211 |
| CASE IH | 900611 | A-900611 |
| CASE IH | S80928 | A-S80928 |
| CASE IH | 3140058 | A-3140058 |
| CASE IH | 60518004 | A-060518004 |
| CASE IH | 3140109 | A-3140109 |
| CASE IH | 938787 | A-938787 |
| CASE IH | 84185053 | A-84185053 |
| CASE IH | 3140006 | A-3140006 |
| CASE IH | 87429954 | A-87429954 |
| CASE IH | 9508558 | A-9508558 |
| CASE IH | 444045 | A-444045 |
| CASE IH | 99466943 | A-99466943 |
| CASE IH | 99466947 | A-99466947 |
| CASE IH | 421173 | A-421173 |
| CASE IH | 84185033 | A-84185033 |
| CASE IH | 60517261 | A-60517261 |
| CASE IH | 60517253 | A-60517253 |
| CASE IH | 130071 | A-130071 |
| CASE IH | 3140053 | A-3140053 |
| CASE IH | 130012 | A-130012 |
| CASE IH | 84240788 | A-84240788 |
| CASE IH | 456216 | A-456216 |
| CASE IH | 1791046 | A-1791046 |
| CASE IH | 87526139 | A-87526139 |
| CASE IH | 87526140 | A-87526140 |
| CASE IH | 130072 | A-130072 |
| CASE IH | 1300721 | A-1300721 |
| CASE IH | 452022 | A-452022 |
| CASE IH | 80452022 | A-80452022 |
| CASE IH | 87671290 | A-87671290 |
| CASE IH | 87671291 | A-87671291 |
| CASE IH | 1301131 | A-1301131 |
| CASE IH | 399058 | A-399058 |
| CASE IH | 84286546 | A-84286546 |
| CASE IH | 87346859 | A-87346859 |
| CASE IH | 9850080 | A-9850080 |
| CASE IH | 9833619 | A-9833619 |
| CASE IH | 87374574 | A-87374574 |
| CASE IH | 3145900 | A-3145900 |
| CASE IH | 84271496 | A-84271496 |



CASE IH

| OEM | OEM  Part No. | PIX  Part No. |
|---------|--|--|
| CASE IH | 3142590 | A-3142590 |
| CASE IH | 379461A1 | A-379461A1 |
| CASE IH | 873541410 | A-873541410 |
| CASE IH | 84075683 | A-84075683 |
| CASE IH | 86634492 | A-86634492 |
| CASE IH | 84342685 | A-84342685 |
| CASE IH | 84342686 | A-84342686 |
| CASE IH | 446971 | A-446971 |
| CASE IH | 60121284 | A-60121284 |
| CASE IH | 244423A4 | A-244423A4 |
| CASE IH | 8403693 | A-8403693 |
| CASE IH | 8403632 | A-8403632 |
| CASE IH | 84074272 | A-84074272 |
| CASE IH | 159639A1 | A-159639A1 |
| CASE IH | 289199A1 | A-289199A1 |
| CASE IH | 289198A1 | A-289198A1 |
| CASE IH | 87456836 | A-87456836 |
| CASE IH | 2213342 | A-2213342 |
| CASE IH | 2929932 | A-2929932 |
| CASE IH | 3012326 | A-3012326 |
| CASE IH | 2900435 | A-2900435 |
| CASE IH | 2928981 | A-2928981 |
| CASE IH | 87528118 | A-87528118 |
| CASE IH | 84365709 | A-84365709 |
| CASE IH | 1966513C2 | A-1966513C2 |
| CASE IH | 190003140029 | A-190003140029 |
| CASE IH | 190003142357 | A-190003142357 |
| CASE IH | 1109080 | A-01109080 |
| CASE IH | 140100600021 | A-140100600021 |
| CASE IH | 190003140007 | A-190003140007 |
| CASE IH | 190003140032 | A-190003140032 |
| CASE IH | 130100600181 | A-130100600181 |
| CASE IH | 141100600141 | A-141100600141 |
| CASE IH | 190003140041 | A-190003140041 |
| CASE IH | 060506933 | A-060506933 |
| CASE IH | 190003142340 | A-190003142340 |
| CASE IH | 190003140013 | A-190003140013 |
| CASE IH | 98-045851 | A-98-045851 |
| CASE IH | 190003142358 | A-190003142358 |
| CASE IH | 190003142350 | A-190003142350 |
| CASE IH | 060038666 | A-060038666 |
| CASE IH | 190003140054 | A-190003140054 |
| CASE IH | 190003142278 | A-190003142278 |
| CASE IH | 190003142270 | A-190003142270 |
| CASE IH | 190003142272 | A-190003142272 |
| CASE IH | 190003142275 | A-190003142275 |
| CASE IH | 190003140030 | A-190003140030 |



| OEM | OEM  Part No. | PIX  Part No. |
|---------|--|--|
| CASE IH | 190003142273 | A-190003142273 |
| CASE IH | 190003140081 | A-190003140081 |
| CASE IH | 190003142532 | A-190003142532 |
| CASE IH | 3142541 | A-3142541 |
| CASE IH | 87304910 | A-87304910 |
| CASE IH | 190003142543 | A-190003142543 |
| CASE IH | 190003140037 | A-190003140037 |
| CASE IH | 190003142557 | A-190003142557 |
| CASE IH | 3142558 | A-3142558 |
| CASE IH | 190003142558 | A-190003142558 |
| CASE IH | 31400010 | A-31400010 |
| CASE IH | 139900270270 | A-139900270270 |
| CASE IH | 190003142503 | A-190003142503 |
| CASE IH | 190003142508 | A-190003142508 |
| CASE IH | 190003142526 | A-190003142526 |
| CASE IH | 190003142516 | A-190003142516 |
| CASE IH | 190003142527 | A-190003142527 |
| CASE IH | 190003142521 | A-190003142521 |
| CASE IH | 190003142504 | A-190003142504 |
| CASE IH | 700711062 | A-700711062 |
| CASE IH | 393271A1 | A-393271A1 |
| CASE IH | 90-8400T1 | A-90-8400T1 |
| CASE IH | 04-133180 | A-04-133180 |
| CASE IH | 98-039777 | A-98-039777 |
| CASE IH | 98-045896 | A-98-045896 |
| CASE IH | 1420001300041 | A-1420001300041 |
| CASE IH | 162000131001 | A-162000131001 |
| CASE IH | 190003140073 | A-190003140073 |
| CASE IH | 190003140064 | A-190003140064 |
| CASE IH | 190003140006 | A-190003140006 |
| CASE IH | 1301001300411 | A-1301001300411 |
| CASE IH | 130300600021 | A-130300600021 |
| CASE IH | 190003140083 | A-190003140083 |
| CASE IH | 01100788 | A-01100788 |
| CASE IH | 190003140047 | A-190003140047 |
| CASE IH | 190003140062 | A-190003140062 |
| CASE IH | 190003149999 | A-190003149999 |
| CASE IH | 01113928 | A-01113928 |
| CASE IH | 98-046005 | A-98-046005 |
| CASE IH | 190003142525 | A-190003142525 |
| CASE IH | 1320001300211 | A-1320001300211 |
| CASE IH | 1401001301321 | A-1401001301321 |
| CASE IH | 1420000600011 | A-1420000600011 |
| CASE IH | 1420000600111 | A-1420000600111 |
| CASE IH | 1399001300031 | A-1399001300031 |
| CASE IH | 190003140053 | A-190003140053 |
| CASE IH | 060191762 | A-060191762 |



CASE IH

| OEM | OEM  Part No. | PIX  Part No. |
|---------|--|--|
| CASE IH | 060500108 | A-060500108 |
| CASE IH | 1420000600121 | A-1420000600121 |
| CASE IH | 1620000600011 | A-1620000600011 |
| CASE IH | 1320000600121 | A-1320000600121 |
| CASE IH | 1620001300031 | A-1620001300031 |
| CASE IH | 060500116 | A-060500116 |
| CASE IH | 1374-310-418 | A-1374-310-418 |
| CASE IH | 98-042446 | A-98-042446 |
| CASE IH | 1401001301311 | A-1401001301311 |
| CASE IH | 190003140020 | A-190003140020 |
| CASE IH | 98-039925 | A-98-039925 |
| CASE IH | 139900270408 | A-139900270408 |
| CASE IH | ND-9003 | A-ND-9003 |
| CASE IH | ND-9317 | A-ND-9317 |
| CASE IH | 060067654 | A-060067654 |
| CASE IH | 01113897 | A-01113897 |
| CASE IH | 01111766 | A-01111766 |
| CASE IH | 01113872 | A-01113872 |
| CASE IH | 190003142590 | A-190003142590 |
| CASE IH | 01111067 | A-01111067 |
| CASE IH | 190003140039 | A-190003140039 |
| CASE IH | 1320001300201 | A-1320001300201 |
| CASE IH | 190003140035 | A-190003140035 |
| CASE IH | 190003140078 | A-190003140078 |
| CASE IH | 700715387 | A-700715387 |
| CASE IH | 700711883 | A-700711883 |
| CASE IH | 86514511 | A-86514511 |
| CASE IH | 610462R1 | A-610462R1 |
| CASE IH | 190003140084 | A-190003140084 |
| CASE IH | 190003142523 | A-190003142523 |
| CASE IH | 700709676 | A-700709676 |
| CASE IH | 542177R2 | A-542177R2 |
| CASE IH | 492102R1 | A-492102R1 |
| CASE IH | 824810C1 | A-824810C1 |
| CASE IH | 190003142710 | A-190003142710 |
| CASE IH | 190003142718 | A-190003142718 |
| CASE IH | 592128R1 | A-592128R1 |
| CASE IH | 181718C1 | A-181718C1 |
| CASE IH | 15166K | A-15166K |
| CASE IH | 824202C1 | A-824202C1 |
| CASE IH | 86517932 | A-86517932 |
| CASE IH | 580026R1 | A-580026R1 |
| CASE IH | 209002C1 | A-209002C1 |
| CASE IH | 824880C1 | A-824880C1 |
| CASE IH | 276565 | A-276565 |
| CASE IH | 824185C1 | A-824185C1 |
| CASE IH | 276799 | A-276799 |



| OEM | OEM  Part No. | PIX  Part No. |
|---------|--|--|
| CASE IH | 1103821 | A-01103821 |
| CASE IH | 98039691 | A-98-039691 |
| CASE IH | 1374310400 | A-1374-310-400 |
| CASE IH | 1104002 | A-01104002 |
| CASE IH | 1101723 | A-01101723 |
| CASE IH | 1113950 | A-01113950 |
| CASE IH | 21206287 | A-021206287 |
| CASE IH | 61015851 | A-061015851 |
| CASE IH | 4240053712 | A-4240053712 |
| CASE IH | 61068992 | A-061068992 |
| CASE IH | 3131095 | A-3131095 |
| CASE IH | 61068984 | A-061068984 |
| CASE IH | 1111661 | A-01111661 |
| CASE IH | 20476355 | A-020476355 |
| CASE IH | 61033443 | A-061033443 |
| CASE IH | 1113550 | A-01113550 |
| CASE IH | 1374310401 | A-1374-310-401 |
| CASE IH | 20953061 | A-020953061 |
| CASE IH | 1113864 | A-01113864 |
| CASE IH | 60007646 | A-060007646 |
| CASE IH | 60067646 | A-060067646 |
| CASE IH | 1111717 | A-01111717 |
| CASE IH | 1113880 | A-01113880 |
| CASE IH | 1112605 | A-01112605 |
| CASE IH | 1374390255 | A-1374-390-255 |
| CASE IH | 20953053 | A-020953053 |
| CASE IH | 1169694 | A-01169694 |
| CASE IH | 61069028 | A-061069028 |
| CASE IH | 190003140080 | A-190003140080 |
| CASE IH | 190003142802 | A-190003142802 |
| CASE IH | 824274C1 | A-824274C1 |
| CASE IH | 87655953 | A-87655953 |
| CASE IH | T32070 | A-T32070 |
| CASE IH | 567947R2 | A-567947R2 |
| CASE IH | 3103014R2 | A-3103014R2 |
| CASE IH | F11139 | A-F11139 |
| CASE IH | 87381877 | A-87381877 |
| CASE IH | 591878R1 | A-591878R1 |
| CASE IH | F7865 | A-F7865 |
| CASE IH | 174637C1 | A-174637C1 |
| CASE IH | 319905A1 | A-319905A1 |
| CASE IH | 86980546 | A-86980546 |
| CASE IH | 824881C1 | A-824881C1 |
| CASE IH | 1108473 | A-01108473 |
| CASE IH | 1169686 | A-01169686 |
| CASE IH | 1111887 | A-01111887 |
| CASE IH | 1374310425 | A-1374-310-425 |



CASE IH

| OEM | OEM  Part No. | PIX  Part No. |
|---------|--|--|
| CASE IH | 21189838 | A-021189838 |
| CASE IH | 60190786 | A-060190786 |
| CASE IH | 1111895 | A-01111895 |
| CASE IH | 1111227 | A-01111227 |
| CASE IH | 1112277 | A-01112277 |
| CASE IH | 60190778 | A-060190778 |
| CASE IH | 1109023 | A-01109023 |
| CASE IH | 3167361R1 | A-3167361R1 |
| CASE IH | 1374310403 | A-1374-310-403 |
| CASE IH | 1374390275 | A-1374-390-275 |
| CASE IH | 51200834 | A-51200834 |
| CASE IH | 217564C1 | A-217564C1 |
| CASE IH | 1265653C1 | A-1265653C1 |
| CASE IH | 98036261 | A-98-036261 |
| CASE IH | 98024334 | A-98-024334 |
| CASE IH | 700717131 | A-700717131 |
| CASE IH | 60178276 | A-060178276 |
| CASE IH | 60187276 | A-060187276 |
| CASE IH | 1113116 | A-01113116 |
| CASE IH | 1170132 | A-01170132 |
| CASE IH | 21365202 | A-021365202 |
| CASE IH | 1251214C1 | A-1251214C1 |
| CASE IH | 61068951 | A-061068951 |
| CASE IH | 11170198 | A-011170198 |
| CASE IH | 1374390129 | A-1374-390-129 |
| CASE IH | 99.0606631 | A-99.060663-1005 |
| CASE IH | T040H02A | A-T040H02-A |
| CASE IH | 181717C1 | A-181717C1 |
| CASE IH | 347157C1 | A-347157C1 |
| CASE IH | 1544594C2 | A-1544594C2 |
| CASE IH | N114635 | A-N114635 |
| CASE IH | 217702C1 | A-217702C1 |
| CASE IH | 1304061C2 | A-1304061C2 |
| CASE IH | 171146C1 | A-171146C1 |
| CASE IH | 217636C1 | A-217636C1 |
| CASE IH | 1418731R1 | A-1418731R1 |
| CASE IH | 599068R1 | A-599068R1 |
| CASE IH | 595921R1 | A-595921R1 |
| CASE IH | 169708C1 | A-169708C1 |
| CASE IH | 856419 | A-856419 |
| CASE IH | 3177182R1 | A-3177182R1 |
| CASE IH | 98039783 | A-98-039783 |
| CASE IH | 98026090 | A-98-026090 |
| CASE IH | 1374310407 | A-1374-310-407 |
| CASE IH | 98042220 | A-98-042220 |
| CASE IH | 98036087 | A-98-036087 |
| CASE IH | 98032070 | A-98-032070 |



| OEM | OEM  Part No. | PIX  Part No. |
|---------|--|--|
| CASE IH | 1374390157 | A-1374-390-157 |
| CASE IH | 99.0607383 | A-99.060738-3023 |
| CASE IH | 99.0607398 | A-99.060739-8023 |
| CASE IH | 98041788 | A-98-041788 |
| CASE IH | 1308489C1 | A-1308489C1 |
| CASE IH | 86976208 | A-86976208 |
| CASE IH | 3167653R1 | A-3167653R1 |
| CASE IH | 87594757 | A-87594757 |
| CASE IH | 1313095C1 | A-1313095C1 |
| CASE IH | 1313097C1 | A-1313097C1 |
| CASE IH | 1015993 | A-1015993 |
| CASE IH | 1015075 | A-1015075 |
| CASE IH | Fh855122 | A-FH855122 |
| CASE IH | 4113598 | A-04-113598 |
| CASE IH | 84262995 | A-84262995 |
| CASE IH | 4109135 | A-04-109135 |
| CASE IH | 4119434 | A-04-119434 |
| CASE IH | 86627797 | A-86627797 |
| CASE IH | 98027803 | A-98-027803 |
| CASE IH | 98039673 | A-98-039673 |
| CASE IH | 98043793 | A-98-043793 |
| CASE IH | 87548076 | A-87548076 |
| CASE IH | 87545997 | A-87545997 |
| CASE IH | 1416604R1 | A-1416604R1 |
| CASE IH | 1406929R1 | A-1406929R1 |
| CASE IH | 139900270478 | A-139900270478 |
| CASE IH | 4122838 | A-04-122838 |
| CASE IH | 4113518 | A-04-113518 |
| CASE IH | 4113516 | A-04-113516 |
| CASE IH | 908383T1 | A-90-8383T1 |
| CASE IH | 906850T1 | A-90-6850T1 |
| CASE IH | 700714140 | A-700714140 |
| CASE IH | 51200293 | A-51200293 |
| CASE IH | 1304181C1 | A-1304181C1 |
| CASE IH | 4114742 | A-04-114742 |
| CASE IH | 461312R1 | A-461312R1 |
| CASE IH | FAR8602680 | A-FAR8602680 |
| CASE IH | 907357T1 | A-90-7357T1 |
| CASE IH | T911557 | A-T911557 |
| CASE IH | 87423309 | A-87423309 |
| CASE IH | J935010 | A-J935010 |
| CASE IH | 87271895 | A-87271895 |
| CASE IH | A77959 | A-A77959 |
| CASE IH | 87398520 | A-87398520 |
| CASE IH | 190003142309 | A-190003142309 |
| CASE IH | 161200090098 | A-161200090098 |
| CASE IH | 190003140079 | A-190003140079 |



CASE IH

| OEM | OEM  Part No. | PIX  Part No. |
|---------|--|--|
| CASE IH | 190003141018 | A-190003141018 |
| CASE IH | 190003142313 | A-190003142313 |
| CASE IH | 190003142325 | A-190003142325 |
| CASE IH | 190003142334 | A-190003142334 |
| CASE IH | 139900270174 | A-139900270174 |
| CASE IH | 190003142284 | A-190003142284 |
| CASE IH | 190003142287 | A-190003142287 |
| CASE IH | 190003142293 | A-190003142293 |
| CASE IH | 3142280 | A-3142280 |
| CASE IH | 190003142291 | A-190003142291 |
| CASE IH | 190003142332 | A-190003142332 |
| CASE IH | 190003142295 | A-190003142295 |
| CASE IH | 190003143470 | A-190003143470 |
| CASE IH | 97-018167 | A-97-018167 |
| CASE IH | 70412C1 | A-70412C1 |
| CASE IH | 706556R2 | A-706556R2 |
| CASE IH | 711118R1 | A-711118R1 |
| CASE IH | 209038C1 | A-209038C1 |
| CASE IH | 599881R1 | A-599881R1 |
| CASE IH | 54857DB | A-54857DB |
| CASE IH | 38331K | A-38331K |
| CASE IH | 489399R1 | A-489399R1 |
| CASE IH | 492923R2 | A-492923R2 |
| CASE IH | 376370R1 | A-376370R1 |
| CASE IH | A22764 | A-A22764 |
| CASE IH | 87451034 | A-87451034 |
| CASE IH | 87755028 | A-87755028 |
| CASE IH | 61546 | A-6-1546 |
| CASE IH | K901111 | A-K901111 |
| CASE IH | 717356R91 | A-717356R91 |
| CASE IH | 3522485M3 | A-3522485M3 |
| CASE IH | D60572 | A-D60572 |
| CASE IH | D59867 | A-D59867 |
| CASE IH | A22765 | A-A22765 |
| CASE IH | 676622R1 | A-676622R1 |
| CASE IH | 596313R1 | A-596313R1 |
| CASE IH | 87715906 | A-87715906 |
| CASE IH | 87393292 | A-87393292 |
| CASE IH | 86989142 | A-86989142 |
| CASE IH | 87492321 | A-87492321 |
| CASE IH | R44131 | A-R44131 |
| CASE IH | 277546A1 | A-277546A1 |
| CASE IH | 51200857 | A-51200857 |
| CASE IH | L105654 | A-L105654 |
| CASE IH | 86514631 | A-86514631 |
| CASE IH | A135826 | A-A135826 |
| CASE IH | L50593 | A-L50593 |



| OEM | OEM  Part No. | PIX  Part No. |
|---------|--|--|
| CASE IH | 2852625 | A-2852625 |
| CASE IH | L57804 | A-L57804 |
| CASE IH | A22608 | A-A22608 |
| CASE IH | 86514609 | A-86514609 |
| CASE IH | 86514617 | A-86514617 |
| CASE IH | 3138935R1 | A-3138935R1 |
| CASE IH | A22763 | A-A22763 |
| CASE IH | D56917 | A-D56917 |
| CASE IH | 904664T1 | A-90-4664T1 |
| CASE IH | L57802 | A-L57802 |
| CASE IH | D60083 | A-D60083 |
| CASE IH | 1420001300051 | A-1420001300051 |
| CASE IH | 87608501 | A-87608501 |
| CASE IH | 1620000600061 | A-1620000600061 |
| CASE IH | 1620000600051 | A-1620000600051 |
| CASE IH | 1620000600071 | A-1620000600071 |
| CASE IH | 1620001300461 | A-1620001300461 |
| CASE IH | 1620001300041 | A-1620001300041 |
| CASE IH | 1620001300071 | A-1620001300071 |
| CASE IH | 1620001300741 | A-1620001300741 |
| CASE IH | A21457 | A-A21457 |
| CASE IH | D73446 | A-D73446 |
| CASE IH | 406097R1 | A-406097R1 |
| CASE IH | 75258258 | A-75258258 |
| CASE IH | 3159827R1 | A-3159827R1 |
| CASE IH | 700715435 | A-700715435 |
| CASE IH | 86401123 | A-86401123 |
| CASE IH | L112651 | A-L112651 |
| CASE IH | A139089 | A-A139089 |
| CASE IH | A11444 | A-A11444 |
| CASE IH | D127502 | A-D127502 |
| CASE IH | 217699C1 | A-217699C1 |
| CASE IH | 1958439C1 | A-1958439C1 |
| CASE IH | 72896C1 | A-72896C1 |
| CASE IH | 612460R1 | A-612460R1 |
| CASE IH | 553079R1 | A-553079R1 |
| CASE IH | 477179R1 | A-477179R1 |
| CASE IH | 203170C1 | A-203170C1 |
| CASE IH | 6135 | A-6-135 |
| CASE IH | 87608414 | A-87608414 |
| CASE IH | 345013R1 | A-345013R1 |
| CASE IH | 306658R1 | A-306658R1 |
| CASE IH | 203651C1 | A-203651C1 |
| CASE IH | 3170159R1 | A-3170159R1 |
| CASE IH | 662901R1 | A-662901R1 |
| CASE IH | 726285R1 | A-726285R1 |
| CASE IH | 1276634C1 | A-1276634C1 |



CASE IH

| OEM | OEM  Part No. | PIX  Part No. |
|---------|--|--|
| CASE IH | 588894R1 | A-588894R1 |
| CASE IH | 11466R | A-11466R |
| CASE IH | 610521C1 | A-610521C1 |
| CASE IH | 201092C1 | A-201092C1 |
| CASE IH | 829356C1 | A-829356C1 |
| CASE IH | 607666R1 | A-607666R1 |
| CASE IH | 3168669R1 | A-3168669R1 |
| CASE IH | 767587R1 | A-767587R1 |
| CASE IH | 665299R1 | A-665299R1 |
| CASE IH | 203644C1 | A-203644C1 |
| CASE IH | 553139R1 | A-553139R1 |
| CASE IH | 555350R2 | A-555350R2 |
| CASE IH | 16651K | A-16651K |
| CASE IH | 561133R2 | A-561133R2 |
| CASE IH | 57158 | A-57158 |
| CASE IH | 217703C1 | A-217703C1 |
| CASE IH | 135462C1 | A-135462C1 |
| CASE IH | 1315244C1 | A-1315244C1 |
| CASE IH | 595348R11 | A-595348R11 |
| CASE IH | 599428R1 | A-599428R1 |
| CASE IH | 1316575C2 | A-1316575C2 |
| CASE IH | 86514497 | A-86514497 |
| CASE IH | 86517915 | A-86517915 |
| CASE IH | 91572 | A-91572 |
| CASE IH | D41985600 | A-D41985600 |
| CASE IH | 599355R1 | A-599355R1 |
| CASE IH | 1101908 | A-01101908 |
| CASE IH | 3175432R1 | A-3175432R1 |
| CASE IH | 832077C1 | A-832077C1 |
| CASE IH | 596222R1 | A-596222R1 |
| CASE IH | 57604 | A-57604 |
| CASE IH | 3136251R1 | A-3136251R1 |
| CASE IH | 793094R1 | A-793094R1 |
| CASE IH | 793094R2 | A-793094R2 |
| CASE IH | 321565C1 | A-321565C1 |
| CASE IH | 668287R2 | A-668287R2 |
| CASE IH | 1253324C2 | A-1253324C2 |
| CASE IH | 607446R1 | A-607446R1 |
| CASE IH | 217698C1 | A-217698C1 |
| CASE IH | 1316574C2 | A-1316574C2 |
| CASE IH | 86509C2 | A-86509C2 |
| CASE IH | 87109130 | A-87109130 |
| CASE IH | 1866324R1 | A-1866324R1 |
| CASE IH | 217700C1 | A-217700C1 |
| CASE IH | 217701C1 | A-217701C1 |
| CASE IH | 3176489R1 | A-3176489R1 |
| CASE IH | 672178R1 | A-672178R1 |



| OEM | OEM  Part No. | PIX  Part No. |
|---------|--|--|
| CASE IH | 203658C1 | A-203658C1 |
| CASE IH | 672177R1 | A-672177R1 |
| CASE IH | 200380C1 | A-200380C1 |
| CASE IH | 200381C2 | A-200381C2 |
| CASE IH | 48042DB | A-48042DB |
| CASE IH | 832044C2 | A-832044C2 |
| CASE IH | 670282R1 | A-670282R1 |
| CASE IH | 667068R1 | A-667068R1 |
| CASE IH | 670144R1 | A-670144R1 |
| CASE IH | 3157738R1 | A-3157738R1 |
| CASE IH | 150816C1 | A-150816C1 |
| CASE IH | 543394R2 | A-543394R2 |
| CASE IH | 1960252C1 | A-1960252C1 |
| CASE IH | 592038R2 | A-592038R2 |
| CASE IH | 87710660 | A-87710660 |
| CASE IH | 89500400185 | A-89500400185 |
| CASE IH | 87710661 | A-87710661 |
| CASE IH | 87564117 | A-87564117 |
| CASE IH | Bn325050 | A-BN325050 |
| CASE IH | 87452843 | A-87452843 |
| CASE IH | 89500341808 | A-89500341808 |
| CASE IH | 902383T1 | A-902383T1 |
| CASE IH | 3911587 | A-3911587 |
| CASE IH | T911567 | A-T911567 |
| CASE IH | A78011 | A-A78011 |
| CASE IH | 56408 | A-56408 |
| CASE IH | 106465C1 | A-106465C1 |
| CASE IH | 87607871 | A-87607871 |
| CASE IH | 87733431 | A-87733431 |
| CASE IH | 492103R1 | A-492103R1 |
| CASE IH | F16447 | A-F16447 |
| CASE IH | 106492C1 | A-106492C1 |
| CASE IH | 555118R1 | A-555118R1 |
| CASE IH | 135594C1 | A-135594C1 |
| CASE IH | 565565R1 | A-565565R1 |
| CASE IH | 457191R2 | A-457191R2 |
| CASE IH | 726278R1 | A-726278R1 |
| CASE IH | 33504 | A-33504 |
| CASE IH | 555048R1 | A-555048R1 |
| CASE IH | 744477R1 | A-744477R1 |
| CASE IH | 1976277C1 | A-1976277C1 |
| CASE IH | 158797C1 | A-158797C1 |
| CASE IH | 562088R1 | A-562088R1 |
| CASE IH | 156445C1 | A-156445C1 |
| CASE IH | 87041779 | A-87041779 |
| CASE IH | 794484R1 | A-794484R1 |
| CASE IH | 87041778 | A-87041778 |

CASE IH



| OEM | OEM  Part No. | PIX  Part No. |
|---------|--|--|
| CASE IH | 3155177R1 | A-3155177R1 |
| CASE IH | 1408855R1 | A-1408855R1 |
| CASE IH | 1407324R1 | A-1407324R1 |
| CASE IH | 153301C1 | A-153301C1 |
| CASE IH | 793398R2 | A-793398R2 |
| CASE IH | 87041731 | A-87041731 |
| CASE IH | 203612C1 | A-203612C1 |
| CASE IH | 185712C1 | A-185712C1 |
| CASE IH | F20033 | A-F20033 |
| CASE IH | 607658R1 | A-607658R1 |
| CASE IH | 793417R1 | A-793417R1 |
| CASE IH | F19549 | A-F19549 |
| CASE IH | F9659 | A-F9659 |
| CASE IH | 1419233R1 | A-1419233R1 |
| CASE IH | M32813 | A-M32813 |
| CASE IH | 172373C1 | A-172373C1 |
| CASE IH | 591881R1 | A-591881R1 |
| CASE IH | 117004C1 | A-117004C1 |
| CASE IH | 793037R2 | A-793037R2 |
| CASE IH | 595621R1 | A-595621R1 |
| CASE IH | F12280 | A-F12280 |
| CASE IH | F14847 | A-F14847 |
| CASE IH | 210185C1 | A-210185C1 |
| CASE IH | 164999C2 | A-164999C2 |
| CASE IH | 55970 | A-55970 |
| CASE IH | 824961C1 | A-824961C1 |
| CASE IH | 189219C1 | A-189219C1 |
| CASE IH | 1374310379 | A-1374-310-379 |
| CASE IH | 1374310381 | A-1374-310-381 |
| CASE IH | 1374310420 | A-1374-310-420 |
| CASE IH | 69791 | A-69791 |
| CASE IH | F20032 | A-F20032 |
| CASE IH | 173109C1 | A-173109C1 |
| CASE IH | 3156216R1 | A-3156216R1 |
| CASE IH | F12604 | A-F12604 |
| CASE IH | F12258 | A-F12258 |
| CASE IH | F13212 | A-F13212 |
| CASE IH | D58998 | A-D58998 |
| CASE IH | 609998R1 | A-609998R1 |
| CASE IH | 1374310380 | A-1374-310-380 |
| CASE IH | 1415197R1 | A-1415197R1 |
| CASE IH | 1374310421 | A-1374-310-421 |
| CASE IH | 98029103 | A-98-029103 |
| CASE IH | 189662C3 | A-189662C3 |
| CASE IH | 3168030R2 | A-3168030R2 |
| CASE IH | 1302174C2 | A-1302174C2 |
| CASE IH | A189285 | A-A189285 |

| OEM | OEM  Part No. | PIX  Part No. |
|---------|--|--|
| CASE IH | 291019C2 | A-291019C2 |
| CASE IH | 907729T1 | A-90-7729T1 |
| CASE IH | 901502T1 | A-90-1502T1 |
| CASE IH | A189039 | A-A189039 |
| CASE IH | 16864 | A-1-6864 |
| CASE IH | 12228 | A-1-2228 |
| CASE IH | 403617R2 | A-403617R2 |
| CASE IH | 829920C1 | A-829920C1 |
| CASE IH | 379966R1 | A-379966R1 |
| CASE IH | 99.0602685 | A-99.060268-5000 |
| CASE IH | 700709214 | A-700709214 |
| CASE IH | 87499975 | A-87499975 |
| CASE IH | D43913 | A-D43913 |
| CASE IH | L51181 | A-L51181 |
| CASE IH | D47563 | A-D47563 |
| CASE IH | R30790 | A-R30790 |
| CASE IH | L71057 | A-L71057 |
| CASE IH | L110293 | A-L110293 |
| CASE IH | 240354R2 | A-240354R2 |
| CASE IH | R28518 | A-R28518 |
| CASE IH | L74972 | A-L74972 |
| CASE IH | R27266 | A-R27266 |
| CASE IH | A64206 | A-A64206 |
| CASE IH | A59296 | A-A59296 |
| CASE IH | 12059 | A-1-2059 |
| CASE IH | 179325C1 | A-179325C1 |
| CASE IH | 190779C1 | A-190779C1 |
| CASE IH | 1407123R | A-1407123R |
| CASE IH | 578096 | A-578096 |
| CASE IH | 1409652R1 | A-1409652R1 |
| CASE IH | 595137R1 | A-595137R1 |
| CASE IH | 3156220R92 | A-3156220R92 |
| CASE IH | F16080 | A-F16080 |
| CASE IH | 169719C1 | A-169719C1 |
| CASE IH | F9468 | A-F9468 |
| CASE IH | 592035R1 | A-592035R1 |
| CASE IH | 3168030R3 | A-3168030R3 |
| CASE IH | 87403165 | A-87403165 |
| CASE IH | 3218477R1 | A-3218477R1 |
| CASE IH | 440085A1 | A-440085A1 |
| CASE IH | D53495 | A-D53495 |
| CASE IH | 98046076 | A-98-046076 |
| CASE IH | 98046372 | A-98-046372 |
| CASE IH | 244423A5 | A-244423A5 |
| CASE IH | 84042180 | 84042180 |
| CASE IH | 09802AB | 09802AB |
| CASE IH | 739734R1 | 739734R1 |



CASE IH



| OEM | OEM  Part No. | PIX  Part No. |
|---------|--|--|
| CASE IH | 247426A1 | 247426A1 |
| CASE IH | 61068968 | 61068968 |
| CASE IH | 60206971 | 60206971 |
| CASE IH | 61069036 | 61069036 |
| CASE IH | 184796C1 | 184796C1 |
| CASE IH | 56408 | 56408 |
| CASE IH | 16651K | 16651K |
| CASE IH | 60206963 | 60206963 |
| CASE IH | 191241 | 191241 |
| CASE IH | 244420 | 244420 |
| CASE IH | 244422 | 244422 |
| CASE IH | 1330499 | 1330499 |
| CASE IH | 1541702A | 1541702A |
| CASE IH | 218509A1 | 218509A1 |
| CASE IH | 228332A1 | 228332A1 |
| CASE IH | 1313097C2 | 1313097C2 |
| CASE IH | 84365262 | 84365262 |
| CASE IH | 197414C1 | 197414C1 |
| CASE IH | 9911861854 | 9911861854 |
| CASE IH | 044000282 | 044000282 |
| CASE IH | 188213C2 | A-188213C2 |
| CASE IH | 80682008 | A-80682008 |
| CASE IH | 89842665 | A-89842665 |
| CASE IH | 84534020 | A-84534020 |
| CASE IH | 84548651 | A-84548651 |
| CASE IH | 124572A1 | A-124572A1 |
| CASE IH | 1308489C2 | A-1308489C2 |
| CASE IH | 1541569C1 | A-1541569C1 |
| CASE IH | 191241C3 | A-191241C3 |
| CASE IH | 191290C1 | A-191290C1 |
| CASE IH | 194528C2 | A-194528C2 |
| CASE IH | 244420A1 | A-244420A1 |
| CASE IH | 413159A1 | A-413159A1 |
| CASE IH | 440498A3 | A-440498A3 |

CASE NEW HOLLAND (CNH)



| OEM | OEM  Part No. | PIX  Part No. |
|-----|--|--|
| CNH | 103579 | A-044000282 |
| CNH | 106991C1 | A-103579 |
| CNH | 11113 | A-106991C1 |
| CNH | 1136712820 | A-11113 |
| CNH | 117120 | A-1136712820 |
| CNH | 1213572C1 | A-117120 |
| CNH | 121960 | A-1213572C1 |
| CNH | 121961 | A-121960 |
| CNH | 124572A1 | A-121961 |
| CNH | 127934 | A-124572A1 |
| CNH | 1288899C5 | A-127934 |
| CNH | 1288900C3 | A-1288899C5 |
| CNH | 130100130041 | A-1288900C3 |
| CNH | 130100130071 | A-130100130041 |
| CNH | 130100130072 | A-130100130071 |
| CNH | 130100130112 | A-130100130072 |
| CNH | 130100130113 | A-130100130112 |
| CNH | 130300060002 | A-130100130113 |
| CNH | 130800060010 | A-130300060002 |
| CNH | 1316573C1 | A-130800060010 |
| CNH | 1316574C1 | A-1316573C1 |
| CNH | 131725 | A-1316574C1 |
| CNH | 1319245C2 | A-131725 |
| CNH | 132000060012 | A-1319245C2 |
| CNH | 132000130020 | A-132000060012 |
| CNH | 1321564C1 | A-132000130020 |
| CNH | 1321565C | A-1321564C1 |
| CNH | 132747 | A-1321565C |
| CNH | 1330311C1 | A-132747 |
| CNH | 133929 | A-1330311C1 |
| CNH | 13394L | A-133929 |
| CNH | 13414 | A-13394L |
| CNH | 137203 | A-13414 |
| CNH | 1374-310-262 | A-137203 |
| CNH | 1374312041 | A-1374-310-262 |
| CNH | 139900270236 | A-1374-312-041 |
| CNH | 140100060002 | A-139900270236 |
| CNH | 140100130131 | A-140100060002 |
| CNH | 140876R1 | A-140100130131 |
| CNH | 1410106R1 | A-140876R1 |
| CNH | 1410642R1 | A-1410106R1 |
| CNH | 1410655R1 | A-1410642R1 |
| CNH | 1410655R91 | A-1410655R1 |
| CNH | 1410692R1 | A-1410655R91 |
| CNH | 1410692R92 | A-1410692R1 |
| CNH | 1410935R1 | A-1410692R92 |
| CNH | 1410975R1 | A-1410935R1 |



CASE NEW HOLLAND (CNH)

| OEM | OEM  Part No. | PIX  Part No. |
|-----|--|--|
| CNH | 1411204R1 | A-1410975R1 |
| CNH | 1411205R1 | A-1411204R1 |
| CNH | 1413433R1 | A-1411205R1 |
| CNH | 1414584R1 | A-1413433R1 |
| CNH | 1414593R1 | A-1414584R1 |
| CNH | 1414856R91 | A-1414593R1 |
| CNH | 1415141R1 | A-1414856R91 |
| CNH | 1415149R1 | A-1415141R1 |
| CNH | 1415261R1 | A-1415149R1 |
| CNH | 1415360R1 | A-1415261R1 |
| CNH | 1415411R1 | A-1415360R1 |
| CNH | 1416434R1 | A-1415411R1 |
| CNH | 1416543R1 | A-1416434R1 |
| CNH | 1416594R1 | A-1416543R1 |
| CNH | 1416764R1 | A-1416594R1 |
| CNH | 1416852R1 | A-1416764R1 |
| CNH | 1417108R1 | A-1416852R1 |
| CNH | 141714R1 | A-1417108R1 |
| CNH | 1417871R1 | A-141714R1 |
| CNH | 1418296R1 | A-1417871R1 |
| CNH | 1418304R1 | A-1418296R1 |
| CNH | 1418394R1 | A-1418304R1 |
| CNH | 1418410R1 | A-1418394R1 |
| CNH | 1418692R1 | A-1418410R1 |
| CNH | 1419232R1 | A-1418692R1 |
| CNH | 1419381R1 | A-1419232R1 |
| CNH | 142000130004 | A-1419381R1 |
| CNH | 142000130005 | A-142000130004 |
| CNH | 142975 | A-142000130005 |
| CNH | 142976 | A-142975 |
| CNH | 143313 | A-142976 |
| CNH | 1440692R92 | A-143313 |
| CNH | 144313 | A-1440692R92 |
| CNH | 144794 | A-144313 |
| CNH | 147849 | A-144794 |
| CNH | 150670C1 | A-147849 |
| CNH | 1537104C1 | A-150670C1 |
| CNH | 156444C1 | A-1537104C1 |
| CNH | 157024 | A-156444C1 |
| CNH | 159267C1 | A-157024 |
| CNH | 159588C1 | A-159267C1 |
| CNH | 161122C1 | A-159588C1 |
| CNH | 162000060001 | A-161122C1 |
| CNH | 162000060006 | A-162000060001 |
| CNH | 162000060007 | A-162000060006 |
| CNH | 162000130003 | A-162000060007 |
| CNH | 162000130007 | A-162000130003 |



| OEM | OEM  Part No. | PIX  Part No. |
|-----|--|--|
| CNH | 162000130046 | A-162000130007 |
| CNH | 162000130074 | A-162000130046 |
| CNH | 163152 | A-162000130074 |
| CNH | 163437 | A-163152 |
| CNH | 164528 | A-163437 |
| CNH | 164544 | A-164528 |
| CNH | 164899C2 | A-164544 |
| CNH | 164900C1 | A-164899C2 |
| CNH | 165419 | A-164900C1 |
| CNH | 166203 | A-165419 |
| CNH | 168080 | A-166203 |
| CNH | 168141 | A-168080 |
| CNH | 168347 | A-168141 |
| CNH | 175585C1 | A-168347 |
| CNH | 179317C1 | A-175585C1 |
| CNH | 179878 | A-179317C1 |
| CNH | 179944 | A-179878 |
| CNH | 179945 | A-179944 |
| CNH | 179946 | A-179945 |
| CNH | 1813095C1 | A-179946 |
| CNH | 183039C1 | A-1813095C1 |
| CNH | 184213 | A-183039C1 |
| CNH | 185471 | A-184213 |
| CNH | 185953 | A-185471 |
| CNH | 1863473 | A-185953 |
| CNH | 188827 | A-1863473 |
| CNH | 18884K | A-188827 |
| CNH | 191241C2 | A-18884K |
| CNH | 191288C2 | A-191241C2 |
| CNH | 192806C1 | A-191288C2 |
| CNH | 1954932C1 | A-192806C1 |
| CNH | 1959837C1 | A-1954932C1 |
| CNH | 197413C1 | A-1959837C1 |
| CNH | 197416C1 | A-197413C1 |
| CNH | 197480C1 | A-197416C1 |
| CNH | 197482C1 | A-197480C1 |
| CNH | 1976906C1 | A-197482C1 |
| CNH | 1977190C1 | A-1976906C1 |
| CNH | 210629C1 | A-1977190C1 |
| CNH | 214252 | A-210629C1 |
| CNH | 218131 | A-214252 |
| CNH | 219250 | A-218131 |
| CNH | 221458 | A-219250 |
| CNH | 224354 | A-221458 |
| CNH | 225915 | A-224354 |
| CNH | 226485 | A-225915 |
| CNH | 226487 | A-226485 |



CASE NEW HOLLAND (CNH)

| OEM | OEM  Part No. | PIX  Part No. |
|-----|--|--|
| CNH | 226488 | A-226487 |
| CNH | 227247 | A-226488 |
| CNH | 228316A1 | A-227247 |
| CNH | 228366 | A-228316A1 |
| CNH | 228673 | A-228366 |
| CNH | 229760 | A-228673 |
| CNH | 230037 | A-229760 |
| CNH | 230041 | A-230037 |
| CNH | 230043 | A-230041 |
| CNH | 230044 | A-230043 |
| CNH | 230046 | A-230044 |
| CNH | 230048 | A-230046 |
| CNH | 230051 | A-230048 |
| CNH | 230053 | A-230051 |
| CNH | 230054 | A-230053 |
| CNH | 230057 | A-230054 |
| CNH | 230059 | A-230057 |
| CNH | 230060 | A-230059 |
| CNH | 230061 | A-230060 |
| CNH | 230062 | A-230061 |
| CNH | 230064 | A-230062 |
| CNH | 23006A | A-230064 |
| CNH | 230073 | A-23006A |
| CNH | 230074 | A-230073 |
| CNH | 230075 | A-230074 |
| CNH | 230076 | A-230075 |
| CNH | 230079 | A-230076 |
| CNH | 230080 | A-230079 |
| CNH | 230101 | A-230080 |
| CNH | 230103 | A-230101 |
| CNH | 230108 | A-230103 |
| CNH | 230151 | A-230108 |
| CNH | 230153 | A-230151 |
| CNH | 230156 | A-230153 |
| CNH | 230172 | A-230156 |
| CNH | 230267 | A-230172 |
| CNH | 230360 | A-230267 |
| CNH | 231583 | A-230360 |
| CNH | 241895A2 | A-231583 |
| CNH | 242307 | A-241895A2 |
| CNH | 243332 | A-242307 |
| CNH | 244853 | A-243332 |
| CNH | 245213 | A-244853 |
| CNH | 246573 | A-245213 |
| CNH | 246773 | A-246573 |
| CNH | 247428A1 | A-246773 |
| CNH | 248265A2 | A-247428A1 |



| OEM | OEM  Part No. | PIX  Part No. |
|-----|--|--|
| CNH | 255402A1 | A-248265A2 |
| CNH | 258442 | A-255402A1 |
| CNH | 259289A1 | A-258442 |
| CNH | 263765 | A-259289A1 |
| CNH | 263766 | A-263765 |
| CNH | 266319 | A-263766 |
| CNH | 266408 | A-266319 |
| CNH | 271471 | A-266408 |
| CNH | 274223 | A-271471 |
| CNH | 275425 | A-274223 |
| CNH | 275426 | A-275425 |
| CNH | 275427 | A-275426 |
| CNH | 280108 | A-275427 |
| CNH | 283105 | A-280108 |
| CNH | 285236 | A-283105 |
| CNH | 2855568 | A-285236 |
| CNH | 286497 | A-2855568 |
| CNH | 288477 | A-286497 |
| CNH | 293956A1 | A-288477 |
| CNH | 301111A1 | A-293956A1 |
| CNH | 301525A1 | A-301111A1 |
| CNH | 3055261R1 | A-301525A1 |
| CNH | 3055525R1 | A-3055261R1 |
| CNH | 309087 | A-3055525R1 |
| CNH | 309364 | A-309087 |
| CNH | 3113342R1 | A-309364 |
| CNH | 31208 | A-3113342R1 |
| CNH | 312256A1 | A-31208 |
| CNH | 312258A1 | A-312256A1 |
| CNH | 312259A1 | A-312258A1 |
| CNH | 312630A1 | A-312259A1 |
| CNH | 31323185 | A-312630A1 |
| CNH | 3167189R1 | A-31323185 |
| CNH | 320935 | A-3167189R1 |
| CNH | 321582 | A-320935 |
| CNH | 321583 | A-321582 |
| CNH | 323413 | A-321583 |
| CNH | 324391 | A-323413 |
| CNH | 324791 | A-324391 |
| CNH | 326471 | A-324791 |
| CNH | 328424 | A-326471 |
| CNH | 3290 | A-328424 |
| CNH | 330198 | A-3290 |
| CNH | 330204 | A-330198 |
| CNH | 330441 | A-330204 |
| CNH | 333255 | A-330441 |
| CNH | 333347 | A-333255 |



CASE NEW HOLLAND (CNH)

| OEM | OEM  Part No. | PIX  Part No. |
|-----|--|--|
| CNH | 334065A | A-333347 |
| CNH | 335258 | A-334065A |
| CNH | 33552 | A-335258 |
| CNH | 336784 | A-33552 |
| CNH | 337415 | A-336784 |
| CNH | 337415A | A-337415 |
| CNH | 340433279 | A-337415A |
| CNH | 350776 | A-340433279 |
| CNH | 352219 | A-350776 |
| CNH | 353584 | A-352219 |
| CNH | 354115 | A-353584 |
| CNH | 356913 | A-354115 |
| CNH | 362499 | A-356913 |
| CNH | 362500 | A-362499 |
| CNH | 364033 | A-362500 |
| CNH | 364418 | A-364033 |
| CNH | 37004 | A-364418 |
| CNH | 375977 | A-37004 |
| CNH | 378672 | A-375977 |
| CNH | 381489 | A-378672 |
| CNH | 382228R2 | A-381489 |
| CNH | 384397 | A-382228R2 |
| CNH | 386155 | A-384397 |
| CNH | 387452 | A-386155 |
| CNH | 387454 | A-387452 |
| CNH | 387460 | A-387454 |
| CNH | 387469 | A-387460 |
| CNH | 387931 | A-387469 |
| CNH | 389069A1 | A-387931 |
| CNH | 389245 | A-389069A1 |
| CNH | 391143 | A-389245 |
| CNH | 391650 | A-391143 |
| CNH | 392134 | A-391650 |
| CNH | 392361 | A-392134 |
| CNH | 393326 | A-392361 |
| CNH | 394425 | A-393326 |
| CNH | 394426 | A-394425 |
| CNH | 395955 | A-394426 |
| CNH | 396543R1 | A-395955 |
| CNH | 396749 | A-396543R1 |
| CNH | 396750 | A-396749 |
| CNH | 397297 | A-396750 |
| CNH | 397297A | A-397297 |
| CNH | 397298 | A-397297A |
| CNH | 398622 | A-397298 |
| CNH | 401192R | A-398622 |
| CNH | 401192R1 | A-401192R |



| OEM | OEM  Part No. | PIX  Part No. |
|-----|--|--|
| CNH | 4015852 | A-401192R1 |
| CNH | 402254R91 | A-4015852 |
| CNH | 410896 | A-402254R91 |
| CNH | 411543 | A-410896 |
| CNH | 417643 | A-411543 |
| CNH | 42001 | A-417643 |
| CNH | 42002 | A-42001 |
| CNH | 420606 | A-42002 |
| CNH | 422281 | A-420606 |
| CNH | 422441 | A-422281 |
| CNH | 424318 | A-422441 |
| CNH | 427455 | A-424318 |
| CNH | 432642 | A-427455 |
| CNH | 432829 | A-432642 |
| CNH | 433639 | A-432829 |
| CNH | 4336392 | A-433639 |
| CNH | 4337469 | A-4336392 |
| CNH | 4340200 | A-4337469 |
| CNH | 434045 | A-4340200 |
| CNH | 434046 | A-434045 |
| CNH | 434047 | A-434046 |
| CNH | 439495 | A-434047 |
| CNH | 439832 | A-439495 |
| CNH | 443775 | A-439832 |
| CNH | 4456409 | A-443775 |
| CNH | 446970A | A-4456409 |
| CNH | 447041 | A-446970A |
| CNH | 4487947 | A-447041 |
| CNH | 450552 | A-4487947 |
| CNH | 451076 | A-450552 |
| CNH | 451481 | A-451076 |
| CNH | 452197R1 | A-451481 |
| CNH | 454990 | A-452197R1 |
| CNH | 4549901 | A-454990 |
| CNH | 455865 | A-4549901 |
| CNH | 4558657 | A-455865 |
| CNH | 4582127 | A-4558657 |
| CNH | 4611312 | A-4582127 |
| CNH | 467261 | A-4611312 |
| CNH | 467783 | A-467261 |
| CNH | 468291 | A-467783 |
| CNH | 468584 | A-468291 |
| CNH | 468759 | A-468584 |
| CNH | 4688853 | A-468759 |
| CNH | 46914 | A-4688853 |
| CNH | 4702438 | A-46914 |
| CNH | 4712148 | A-4702438 |



CASE NEW HOLLAND (CNH)

| OEM | OEM  Part No. | PIX  Part No. |
|-----|--|--|
| CNH | 47135840 | A-4712148 |
| CNH | 47137503 | A-47135840 |
| CNH | 4716470 | A-47137503 |
| CNH | 4716471 | A-4716470 |
| CNH | 472177R1 | A-4716471 |
| CNH | 4728940 | A-472177R1 |
| CNH | 4736293 | A-4728940 |
| CNH | 4739709 | A-4736293 |
| CNH | 4745187 | A-4739709 |
| CNH | 47486558 | A-4745187 |
| CNH | 47486562 | A-47486558 |
| CNH | 47503515 | A-47486562 |
| CNH | 475694R1 | A-47503515 |
| CNH | 475739R1 | A-475694R1 |
| CNH | 47608706 | A-475739R1 |
| CNH | 47611637 | A-47608706 |
| CNH | 47611710 | A-47611637 |
| CNH | 47620157 | A-47611710 |
| CNH | 47620214 | A-47620157 |
| CNH | 47624033 | A-47620214 |
| CNH | 47636649 | A-47624033 |
| CNH | 477180R1 | A-47636649 |
| CNH | 478263R91 | A-477180R1 |
| CNH | 47840644 | A-478263R91 |
| CNH | 4796442 | A-47840644 |
| CNH | 4796652 | A-4796442 |
| CNH | 479898 | A-4796652 |
| CNH | 4814275 | A-479898 |
| CNH | 4816716 | A-4814275 |
| CNH | 4819722 | A-4816716 |
| CNH | 482222R2 | A-4819722 |
| CNH | 482223R2 | A-482222R2 |
| CNH | 48224 | A-482223R2 |
| CNH | 4838527 | A-48224 |
| CNH | 483878R1 | A-4838527 |
| CNH | 4843796 | A-483878R1 |
| CNH | 486543R3 | A-4843796 |
| CNH | 487046R1 | A-486543R3 |
| CNH | 489608R91 | A-487046R1 |
| CNH | 495756R1 | A-489608R91 |
| CNH | 4975233 | A-495756R1 |
| CNH | 500344766 | A-4975233 |
| CNH | 500386112 | A-500344766 |
| CNH | 501543 | A-500386112 |
| CNH | 504145203 | A-501543 |
| CNH | 51200826 | A-504145203 |
| CNH | 513220 | A-51200826 |



| OEM | OEM  Part No. | PIX  Part No. |
|-----|--|--|
| CNH | 5140011 | A-513220 |
| CNH | 5140012 | A-5140011 |
| CNH | 5140013 | A-5140012 |
| CNH | 5140014 | A-5140013 |
| CNH | 5140015 | A-5140014 |
| CNH | 518300 | A-5140015 |
| CNH | 5186232 | A-518300 |
| CNH | 529944 | A-5186232 |
| CNH | 540547R1 | A-529944 |
| CNH | 540609R1 | A-540547R1 |
| CNH | 546372R1 | A-540609R1 |
| CNH | 546499R1 | A-546372R1 |
| CNH | 551911R1 | A-546499R1 |
| CNH | 553456R2 | A-551911R1 |
| CNH | 555045R1 | A-553456R2 |
| CNH | 56212 | A-555045R1 |
| CNH | 56213 | A-56212 |
| CNH | 56226 | A-56213 |
| CNH | 567451 | A-56226 |
| CNH | 571684 | A-567451 |
| CNH | 573286 | A-571684 |
| CNH | 573957 | A-573286 |
| CNH | 57471 | A-573957 |
| CNH | 575439 | A-57471 |
| CNH | 576135 | A-575439 |
| CNH | 576773 | A-576135 |
| CNH | 576776 | A-576773 |
| CNH | 577900 | A-576776 |
| CNH | 57902 | A-577900 |
| CNH | 57903 | A-57902 |
| CNH | 58532C1 | A-57903 |
| CNH | 590153 | A-58532C1 |
| CNH | 592712 | A-590153 |
| CNH | 593325 | A-592712 |
| CNH | 593648R2 | A-593325 |
| CNH | 593802R1 | A-593648R2 |
| CNH | 595185R21 | A-593802R1 |
| CNH | 598436 | A-595185R21 |
| CNH | 600A02 | A-598436 |
| CNH | 601388 | A-600A02 |
| CNH | 605529 | A-601388 |
| CNH | 605988 | A-605529 |
| CNH | 61320659 | A-605988 |
| CNH | 614663R1 | A-61320659 |
| CNH | 616004C1 | A-614663R1 |
| CNH | 616484 | A-616004C1 |
| CNH | 61-830 | A-616484 |



CASE NEW HOLLAND (CNH)

| OEM | OEM  Part No. | PIX  Part No. |
|-----|--|--|
| CNH | 619657 | A-61-830 |
| CNH | 620945 | A-619657 |
| CNH | 621024 | A-620945 |
| CNH | 6215233 | A-621024 |
| CNH | 630406 | A-6215233 |
| CNH | 63106 | A-630406 |
| CNH | 632243 | A-63106 |
| CNH | 632679 | A-632243 |
| CNH | 632889 | A-632679 |
| CNH | 633512 | A-632889 |
| CNH | 634069 | A-633512 |
| CNH | 634563 | A-634069 |
| CNH | 634564 | A-634563 |
| CNH | 635042 | A-634564 |
| CNH | 637782 | A-635042 |
| CNH | 63804 | A-637782 |
| CNH | 640091 | A-63804 |
| CNH | 640891 | A-640091 |
| CNH | 64212 | A-640891 |
| CNH | 64218 | A-64212 |
| CNH | 64234 | A-64218 |
| CNH | 642920 | A-64234 |
| CNH | 643076 | A-642920 |
| CNH | 643353 | A-643076 |
| CNH | 643574 | A-643353 |
| CNH | 648040 | A-643574 |
| CNH | 65306301 | A-648040 |
| CNH | 65487 | A-65306301 |
| CNH | 66351 | A-65487 |
| CNH | 66813 | A-66351 |
| CNH | 66869 | A-66813 |
| CNH | 668929R1 | A-66869 |
| CNH | 66973 | A-668929R1 |
| CNH | 673685RI | A-66973 |
| CNH | 676620R1 | A-673685RI |
| CNH | 679215 | A-676620R1 |
| CNH | 683846C1 | A-679215 |
| CNH | 694676 | A-683846C1 |
| CNH | 695648 | A-694676 |
| CNH | 696719 | A-695648 |
| CNH | 699351 | A-696719 |
| CNH | 700.055.627K | A-699351 |
| CNH | 700052041 | A-700.055.627K |
| CNH | 700057604 | A-700052041 |
| CNH | 700705503 | A-700057604 |
| CNH | 700708836 | A-700705503 |
| CNH | 700708968 | A-700708836 |



| OEM | OEM  Part No. | PIX  Part No. |
|-----|--|--|
| CNH | 700709489 | A-700708968 |
| CNH | 700710289 | A-700709489 |
| CNH | 700714215 | A-700710289 |
| CNH | 700717699 | A-700714215 |
| CNH | 700717886 | A-700717699 |
| CNH | 700718206 | A-700717886 |
| CNH | 703274 | A-700718206 |
| CNH | 705807 | A-703274 |
| CNH | 70663945 | A-705807 |
| CNH | 708133 | A-70663945 |
| CNH | 708177 | A-708133 |
| CNH | 708178 | A-708177 |
| CNH | 708712 | A-708178 |
| CNH | 709414 | A-708712 |
| CNH | 709502R1 | A-709414 |
| CNH | 709806 | A-709502R1 |
| CNH | 710754 | A-709806 |
| CNH | 711704 | A-710754 |
| CNH | 712320 | A-711704 |
| CNH | 713281 | A-712320 |
| CNH | 713902 | A-713281 |
| CNH | 71419256 | A-713902 |
| CNH | 71460935 | A-71419256 |
| CNH | 71466146 | A-71460935 |
| CNH | 71470863 | A-71466146 |
| CNH | 71472992 | A-71470863 |
| CNH | 715130 | A-71472992 |
| CNH | 715180 | A-715130 |
| CNH | 715782 | A-715180 |
| CNH | 716258 | A-715782 |
| CNH | 716415 | A-716258 |
| CNH | 717075 | A-716415 |
| CNH | 717399 | A-717075 |
| CNH | 719536 | A-717399 |
| CNH | 72106723 | A-719536 |
| CNH | 72106738 | A-72106723 |
| CNH | 73075783 | A-72106738 |
| CNH | 73128581 | A-73075783 |
| CNH | 73148503 | A-73128581 |
| CNH | 73153341 | A-73148503 |
| CNH | 73157291 | A-73153341 |
| CNH | 73159031 | A-73157291 |
| CNH | 73162121 | A-73159031 |
| CNH | 7436771 | A-73162121 |
| CNH | 747403 | A-7436771 |
| CNH | 748004 | A-747403 |
| CNH | 750045 | A-748004 |



CASE NEW HOLLAND (CNH)

| OEM | OEM  Part No. | PIX  Part No. |
|-----|--|--|
| CNH | 750166 | A-750045 |
| CNH | 7502685 | A-750166 |
| CNH | 75250835 | A-7502685 |
| CNH | 75256773 | A-75250835 |
| CNH | 75257166 | A-75256773 |
| CNH | 75263885 | A-75257166 |
| CNH | 753063 | A-75263885 |
| CNH | 75327255 | A-753063 |
| CNH | 7542859 | A-75327255 |
| CNH | 7543887 | A-7542859 |
| CNH | 7543899 | A-7543887 |
| CNH | 754423 | A-7543899 |
| CNH | 755778 | A-754423 |
| CNH | 75629 | A-755778 |
| CNH | 756971 | A-75629 |
| CNH | 757100 | A-756971 |
| CNH | 757725 | A-757100 |
| CNH | 758632 | A-757725 |
| CNH | 758728 | A-758632 |
| CNH | 76017908 | A-758728 |
| CNH | 76040165 | A-76017908 |
| CNH | 76053579 | A-76040165 |
| CNH | 76073151 | A-76053579 |
| CNH | 76195548 | A-76073151 |
| CNH | 76195551 | A-76195548 |
| CNH | 76195553 | A-76195551 |
| CNH | 76195578 | A-76195553 |
| CNH | 76289 | A-76195578 |
| CNH | 763952 | A-76289 |
| CNH | 76610068 | A-763952 |
| CNH | 782170 | A-76610068 |
| CNH | 783511 | A-782170 |
| CNH | 7855265 | A-783511 |
| CNH | 7855745 | A-7855265 |
| CNH | 785734 | A-7855745 |
| CNH | 786310 | A-785734 |
| CNH | 787800 | A-786310 |
| CNH | 79040265 | A-787800 |
| CNH | 79097149 | A-79040265 |
| CNH | 793037R1 | A-79097149 |
| CNH | 795008 | A-793037R1 |
| CNH | 79522R1 | A-795008 |
| CNH | 796624 | A-79522R1 |
| CNH | 79742C1 | A-796624 |
| CNH | 798132 | A-79742C1 |
| CNH | 80066870 | A-798132 |
| CNH | 80138504 | A-80066870 |

| OEM | OEM  Part No. | PIX  Part No. |
|-----|--|--|
| CNH | 80226486 | A-80138504 |
| CNH | 80230029 | A-80226486 |
| CNH | 80230037 | A-80230029 |
| CNH | 80230038 | A-80230037 |
| CNH | 80230040 | A-80230038 |
| CNH | 80230044 | A-80230040 |
| CNH | 80230045 | A-80230044 |
| CNH | 80230046 | A-80230045 |
| CNH | 80230048 | A-80230046 |
| CNH | 80230049 | A-80230048 |
| CNH | 80230050 | A-80230049 |
| CNH | 80230051 | A-80230050 |
| CNH | 80230052 | A-80230051 |
| CNH | 80230053 | A-80230052 |
| CNH | 80230054 | A-80230053 |
| CNH | 80230061 | A-80230054 |
| CNH | 80230063 | A-80230061 |
| CNH | 80230064 | A-80230063 |
| CNH | 80230065 | A-80230064 |
| CNH | 80230066 | A-80230065 |
| CNH | 80230068 | A-80230066 |
| CNH | 80230069 | A-80230068 |
| CNH | 80230070 | A-80230069 |
| CNH | 80230071 | A-80230070 |
| CNH | 80230074 | A-80230071 |
| CNH | 80230075 | A-80230074 |
| CNH | 80230079 | A-80230075 |
| CNH | 80230101 | A-80230079 |
| CNH | 80230127 | A-80230101 |
| CNH | 80230131 | A-80230127 |
| CNH | 80230143 | A-80230131 |
| CNH | 80230154 | A-80230143 |
| CNH | 80230267 | A-80230154 |
| CNH | 80244025 | A-80230267 |
| CNH | 80246727 | A-80244025 |
| CNH | 80246978 | A-80246727 |
| CNH | 80246980 | A-80246978 |
| CNH | 80247782 | A-80246980 |
| CNH | 80248332 | A-80247782 |
| CNH | 80254093 | A-80248332 |
| CNH | 80259346 | A-80254093 |
| CNH | 80259477 | A-80259346 |
| CNH | 80261000 | A-80259477 |
| CNH | 80261001 | A-80261000 |
| CNH | 80264557 | A-80261001 |
| CNH | 80284521 | A-80264557 |
| CNH | 80309087 | A-80284521 |



CASE NEW HOLLAND (CNH)

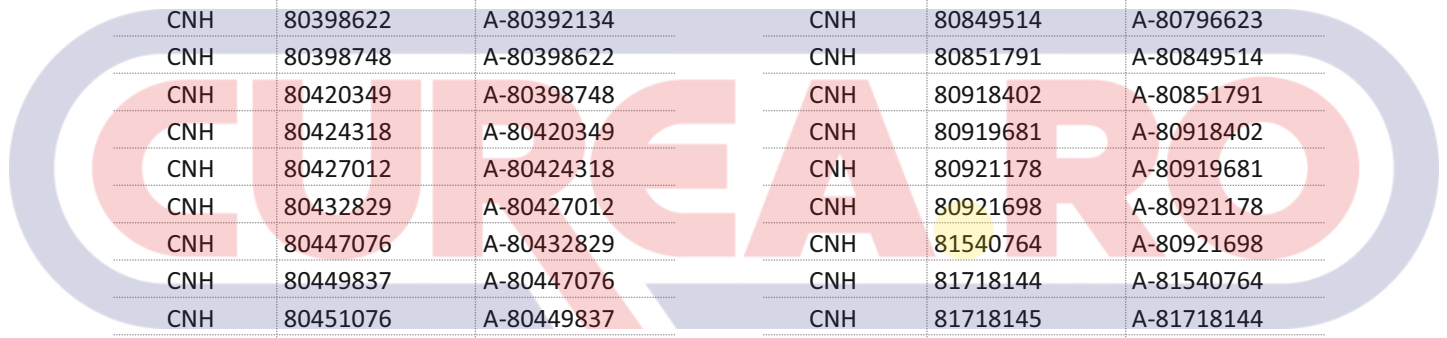

| OEM | OEM  Part No. | PIX  Part No. |
|------------|---|---|
| CNH | 80320059 | A-80309087 |
| CNH | 80326298 | A-80320059 |
| CNH | 80326954 | A-80326298 |
| CNH | 80327024 | A-80326954 |
| CNH | 80327040 | A-80327024 |
| CNH | 80327041 | A-80327040 |
| CNH | 80327062 | A-80327041 |
| CNH | 80328424 | A-80327062 |
| CNH | 80330204 | A-80328424 |
| CNH | 80331019 | A-80330204 |
| CNH | 80355797 | A-80331019 |
| CNH | 80362499 | A-80355797 |
| CNH | 80364418 | A-80362499 |
| CNH | 80367659 | A-80364418 |
| CNH | 80373401 | A-80367659 |
| CNH | 80387452 | A-80373401 |
| CNH | 80391142 | A-80387452 |
| CNH | 80392134 | A-80391142 |
| CNH | 80398622 | A-80392134 |
| CNH | 80398748 | A-80398622 |
| CNH | 80420349 | A-80398748 |
| CNH | 80424318 | A-80420349 |
| CNH | 80427012 | A-80424318 |
| CNH | 80432829 | A-80427012 |
| CNH | 80447076 | A-80432829 |
| CNH | 80449837 | A-80447076 |
| CNH | 80451076 | A-80449837 |
| CNH | 80455649 | A-80451076 |
| CNH | 80457309 | A-80455649 |
| CNH | 80570221 | A-80457309 |
| CNH | 80571926 | A-80570221 |
| CNH | 80576771 | A-80571926 |
| CNH | 80576772 | A-80576771 |
| CNH | 80576774 | A-80576772 |
| CNH | 80577900 | A-80576774 |
| CNH | 80579364 | A-80577900 |
| CNH | 80612305 | A-80579364 |
| CNH | 80614040 | A-80612305 |
| CNH | 80618040 | A-80614040 |
| CNH | 80619748 | A-80618040 |
| CNH | 80621104 | A-80619748 |
| CNH | 80694982 | A-80621104 |
| CNH | 80699268 | A-80694982 |
| CNH | 80703747 | A-80699268 |
| CNH | 80716253 | A-80703747 |
| CNH | 80716254 | A-80716253 |
| CNH | 80716414 | A-80716254 |

| OEM | OEM  Part No. | PIX  Part No. |
|------------|---|---|
| CNH | 80716416 | A-80716414 |
| CNH | 80717699 | A-80716416 |
| CNH | 80717700 | A-80717699 |
| CNH | 80746890 | A-80717700 |
| CNH | 80746893 | A-80746890 |
| CNH | 80746894 | A-80746893 |
| CNH | 80747177 | A-80746894 |
| CNH | 80748004 | A-80747177 |
| CNH | 80750045 | A-80748004 |
| CNH | 80750290 | A-80750045 |
| CNH | 80750318 | A-80750290 |
| CNH | 80751626 | A-80750318 |
| CNH | 80755808 | A-80751626 |
| CNH | 80773300 | A-80755808 |
| CNH | 80774747 | A-80773300 |
| CNH | 807852R1 | A-80774747 |
| CNH | 80792809 | A-807852R1 |
| CNH | 80796623 | A-80792809 |
| CNH | 80849514 | A-80796623 |
| CNH | 80851791 | A-80849514 |
| CNH | 80918402 | A-80851791 |
| CNH | 80919681 | A-80918402 |
| CNH | 80921178 | A-80919681 |
| CNH | 80921698 | A-80921178 |
| CNH | 81540764 | A-80921698 |
| CNH | 81718144 | A-81540764 |
| CNH | 81718145 | A-81718144 |
| CNH | 81718146 | A-81718145 |
| CNH | 81865046 | A-81718146 |
| CNH | 82007330 | A-81865046 |
| CNH | 82012177 | A-82007330 |
| CNH | 82021010 | A-82012177 |
| CNH | 822022 | A-82021010 |
| CNH | 822427 | A-822022 |
| CNH | 822811R1 | A-822427 |
| CNH | 823233R1 | A-822811R1 |
| CNH | 823244R91 | A-823233R1 |
| CNH | 823244R92 | A-823244R91 |
| CNH | 823644 | A-823244R92 |
| CNH | 824175 | A-823644 |
| CNH | 824176 | A-824175 |
| CNH | 824182 | A-824176 |
| CNH | 824202R1 | A-824182 |
| CNH | 824516 | A-824202R1 |
| CNH | 824517 | A-824516 |
| CNH | 824801 | A-824517 |
| CNH | 825238 | A-824801 |







CASE NEW HOLLAND (CNH)

| OEM | OEM  Part No. | PIX  Part No. |
|-----|--|--|
| CNH | 825343 | A-825238 |
| CNH | 825399 | A-825343 |
| CNH | 825673R1 | A-825399 |
| CNH | 825942C1 | A-825673R1 |
| CNH | 826606R1 | A-825942C1 |
| CNH | 826675R1 | A-826606R1 |
| CNH | 826676R1 | A-826675R1 |
| CNH | 826677R1 | A-826676R1 |
| CNH | 826678R1 | A-826677R1 |
| CNH | 826705R1 | A-826678R1 |
| CNH | 826724R1 | A-826705R1 |
| CNH | 826725R1 | A-826724R1 |
| CNH | 826726R1 | A-826725R1 |
| CNH | 826727R1 | A-826726R1 |
| CNH | 826729R1 | A-826727R1 |
| CNH | 826730R1 | A-826729R1 |
| CNH | 826731R1 | A-826730R1 |
| CNH | 826732R1 | A-826731R1 |
| CNH | 826733R1 | A-826732R1 |
| CNH | 826734R1 | A-826733R1 |
| CNH | 826735R1 | A-826734R1 |
| CNH | 826736R1 | A-826735R1 |
| CNH | 826738R1 | A-826736R1 |
| CNH | 826740R1 | A-826738R1 |
| CNH | 826973R1 | A-826740R1 |
| CNH | 827339R2 | A-826973R1 |
| CNH | 827941R1 | A-827339R2 |
| CNH | 829499R1 | A-827941R1 |
| CNH | 829506R1 | A-829499R1 |
| CNH | 829537R1 | A-829506R1 |
| CNH | 829581R1 | A-829537R1 |
| CNH | 829598R1 | A-829581R1 |
| CNH | 82989064 | A-829598R1 |
| CNH | 83910824 | A-82989064 |
| CNH | 84000189 | A-83910824 |
| CNH | 84000190 | A-84000189 |
| CNH | 84000191 | A-84000190 |
| CNH | 84002709 | A-84000191 |
| CNH | 84005357 | A-84002709 |
| CNH | 84012975 | A-84005357 |
| CNH | 84017742 | A-84012975 |
| CNH | 84018998 | A-84017742 |
| CNH | 84021488 | A-84018998 |
| CNH | 84021505 | A-84021488 |
| CNH | 84021588 | A-84021505 |
| CNH | 84021590 | A-84021588 |
| CNH | 84021863 | A-84021590 |



| OEM | OEM  Part No. | PIX  Part No. |
|-----|--|--|
| CNH | 84022215 | A-84021863 |
| CNH | 84022807 | A-84022215 |
| CNH | 84023912 | A-84022807 |
| CNH | 84026761 | A-84023912 |
| CNH | 84036579 | A-84026761 |
| CNH | 84037815 | A-84036579 |
| CNH | 84038109 | A-84037815 |
| CNH | 84043106 | A-84038109 |
| CNH | 84056995 | A-84043106 |
| CNH | 84057578 | A-84056995 |
| CNH | 84057609 | A-84057578 |
| CNH | 84058338 | A-84057609 |
| CNH | 84061953 | A-84058338 |
| CNH | 84064309 | A-84061953 |
| CNH | 84128638 | A-84064309 |
| CNH | 84128639 | A-84128638 |
| CNH | 84144544 | A-84128639 |
| CNH | 84175582 | A-84144544 |
| CNH | 84214719 | A-84175582 |
| CNH | 84214729 | A-84214719 |
| CNH | 84214730 | A-84214729 |
| CNH | 84214731 | A-84214730 |
| CNH | 84214733 | A-84214731 |
| CNH | 84214734 | A-84214733 |
| CNH | 84214735 | A-84214734 |
| CNH | 84214736 | A-84214735 |
| CNH | 84214737 | A-84214736 |
| CNH | 84214738 | A-84214737 |
| CNH | 84214739 | A-84214738 |
| CNH | 84214740 | A-84214739 |
| CNH | 84214741 | A-84214740 |
| CNH | 84214742 | A-84214741 |
| CNH | 84214743 | A-84214742 |
| CNH | 84214744 | A-84214743 |
| CNH | 84214745 | A-84214744 |
| CNH | 84214746 | A-84214745 |
| CNH | 84214747 | A-84214746 |
| CNH | 84214748 | A-84214747 |
| CNH | 84214749 | A-84214748 |
| CNH | 84222986 | A-84214749 |
| CNH | 84222987 | A-84222986 |
| CNH | 84222988 | A-84222987 |
| CNH | 84229205 | A-84222988 |
| CNH | 842516 | A-84229205 |
| CNH | 84281470 | A-842516 |
| CNH | 84345674 | A-84281470 |
| CNH | 84406044 | A-84345674 |



CASE NEW HOLLAND (CNH)

| OEM | OEM  Part No. | PIX  Part No. |
|-----|--|--|
| CNH | 84441893 | A-84406044 |
| CNH | 84447961 | A-84441893 |
| CNH | 84448591 | A-84447961 |
| CNH | 84449048 | A-84448591 |
| CNH | 84449765 | A-84449048 |
| CNH | 84464057 | A-84449765 |
| CNH | 84491659 | A-84464057 |
| CNH | 84492392 | A-84491659 |
| CNH | 84657C1 | A-84492392 |
| CNH | 84766C1 | A-84657C1 |
| CNH | 84811C1 | A-84766C1 |
| CNH | 84817622 | A-84811C1 |
| CNH | 84817628 | A-84817622 |
| CNH | 84817629 | A-84817628 |
| CNH | 84817630 | A-84817629 |
| CNH | 84817632 | A-84817630 |
| CNH | 84817633 | A-84817632 |
| CNH | 84817636 | A-84817633 |
| CNH | 84817639 | A-84817636 |
| CNH | 84817640 | A-84817639 |
| CNH | 84818387 | A-84817640 |
| CNH | 84818393 | A-84818387 |
| CNH | 84981372 | A-84818393 |
| CNH | 849888 | A-84981372 |
| CNH | 84994983 | A-849888 |
| CNH | 84994984 | A-84994983 |
| CNH | 84994987 | A-84994984 |
| CNH | 84995733 | A-84994987 |
| CNH | 84998862 | A-84995733 |
| CNH | 851123 | A-84998862 |
| CNH | 855064 | A-851123 |
| CNH | 858900 | A-855064 |
| CNH | 86013676 | A-858900 |
| CNH | 86502470 | A-86013676 |
| CNH | 86502471 | A-86502470 |
| CNH | 86510178 | A-86502471 |
| CNH | 86514496 | A-86510178 |
| CNH | 86514498 | A-86514496 |
| CNH | 86514499 | A-86514498 |
| CNH | 86514508 | A-86514499 |
| CNH | 86514514 | A-86514508 |
| CNH | 86514517 | A-86514514 |
| CNH | 86514518 | A-86514517 |
| CNH | 86514519 | A-86514518 |
| CNH | 86514522 | A-86514519 |
| CNH | 86514524 | A-86514522 |
| CNH | 86514525 | A-86514524 |



| OEM | OEM  Part No. | PIX  Part No. |
|-----|--|--|
| CNH | 86514527 | A-86514525 |
| CNH | 86514528 | A-86514527 |
| CNH | 86514529 | A-86514528 |
| CNH | 86514532 | A-86514529 |
| CNH | 86514535 | A-86514532 |
| CNH | 86514565 | A-86514535 |
| CNH | 86514566 | A-86514565 |
| CNH | 86514571 | A-86514566 |
| CNH | 86514588 | A-86514571 |
| CNH | 86514595 | A-86514588 |
| CNH | 86514597 | A-86514595 |
| CNH | 86514598 | A-86514597 |
| CNH | 86514599 | A-86514598 |
| CNH | 86514600 | A-86514599 |
| CNH | 86514603 | A-86514600 |
| CNH | 86514605 | A-86514603 |
| CNH | 86514607 | A-86514605 |
| CNH | 86514610 | A-86514607 |
| CNH | 86514613 | A-86514610 |
| CNH | 86514614 | A-86514613 |
| CNH | 86514618 | A-86514614 |
| CNH | 86514621 | A-86514618 |
| CNH | 86514623 | A-86514621 |
| CNH | 86514625 | A-86514623 |
| CNH | 86514629 | A-86514625 |
| CNH | 86514637 | A-86514629 |
| CNH | 86514639 | A-86514637 |
| CNH | 86514641 | A-86514639 |
| CNH | 86514988 | A-86514641 |
| CNH | 86514991 | A-86514988 |
| CNH | 86514994 | A-86514991 |
| CNH | 86514996 | A-86514994 |
| CNH | 86514997 | A-86514996 |
| CNH | 86516456 | A-86514997 |
| CNH | 86516668 | A-86516456 |
| CNH | 86517679 | A-86516668 |
| CNH | 86517684 | A-86517679 |
| CNH | 86517908 | A-86517684 |
| CNH | 86517911 | A-86517908 |
| CNH | 86517912 | A-86517911 |
| CNH | 86517914 | A-86517912 |
| CNH | 86517935 | A-86517914 |
| CNH | 86517939 | A-86517935 |
| CNH | 86517948 | A-86517939 |
| CNH | 86517953 | A-86517948 |
| CNH | 86518884 | A-86517953 |
| CNH | 86518885 | A-86518884 |



CASE NEW HOLLAND (CNH)

| OEM | OEM  Part No. | PIX  Part No. |
|-----|--|--|
| CNH | 86518887 | A-86518885 |
| CNH | 86518889 | A-86518887 |
| CNH | 86518901 | A-86518889 |
| CNH | 86518902 | A-86518901 |
| CNH | 86518903 | A-86518902 |
| CNH | 86518904 | A-86518903 |
| CNH | 86518906 | A-86518904 |
| CNH | 86518907 | A-86518906 |
| CNH | 86518910 | A-86518907 |
| CNH | 86518911 | A-86518910 |
| CNH | 86518912 | A-86518911 |
| CNH | 86518919 | A-86518912 |
| CNH | 86518922 | A-86518919 |
| CNH | 86518924 | A-86518922 |
| CNH | 86518941 | A-86518924 |
| CNH | 86520007 | A-86518941 |
| CNH | 86520008 | A-86520007 |
| CNH | 86527220 | A-86520008 |
| CNH | 86536809 | A-86527220 |
| CNH | 86556030 | A-86536809 |
| CNH | 86564289 | A-86556030 |
| CNH | 86565446 | A-86564289 |
| CNH | 86578110 | A-86565446 |
| CNH | 86584741 | A-86578110 |
| CNH | 86596697 | A-86584741 |
| CNH | 86627789 | A-86596697 |
| CNH | 86627792 | A-86627789 |
| CNH | 86627793 | A-86627792 |
| CNH | 86627794 | A-86627793 |
| CNH | 86627795 | A-86627794 |
| CNH | 86629763 | A-86627795 |
| CNH | 86629783 | A-86629763 |
| CNH | 86729096 | A-86629783 |
| CNH | 86837555 | A-86729096 |
| CNH | 87000216 | A-86837555 |
| CNH | 87020184 | A-87000216 |
| CNH | 87020285 | A-87020184 |
| CNH | 87020286 | A-87020285 |
| CNH | 87031438 | A-87020286 |
| CNH | 87031441 | A-87031438 |
| CNH | 87041732 | A-87031441 |
| CNH | 87053805 | A-87041732 |
| CNH | 87056837 | A-87053805 |
| CNH | 87301964 | A-87056837 |
| CNH | 87309962 | A-87301964 |
| CNH | 87309963 | A-87309962 |
| CNH | 87316555 | A-87309963 |



| OEM | OEM  Part No. | PIX  Part No. |
|-----|--|--|
| CNH | 87316556 | A-87316555 |
| CNH | 87323050 | A-87316556 |
| CNH | 87324567 | A-87323050 |
| CNH | 87344277 | A-87324567 |
| CNH | 87347456 | A-87344277 |
| CNH | 87349745 | A-87347456 |
| CNH | 87359824 | A-87349745 |
| CNH | 87374472 | A-87359824 |
| CNH | 87382455 | A-87374472 |
| CNH | 87427363 | A-87382455 |
| CNH | 87438128 | A-87427363 |
| CNH | 87454410 | A-87438128 |
| CNH | 87485645 | A-87454410 |
| CNH | 87492864 | A-87485645 |
| CNH | 87492866 | A-87492864 |
| CNH | 87492867 | A-87492866 |
| CNH | 87492869 | A-87492867 |
| CNH | 87492875 | A-87492869 |
| CNH | 87492876 | A-87492875 |
| CNH | 87492878 | A-87492876 |
| CNH | 87492881 | A-87492878 |
| CNH | 87492889 | A-87492881 |
| CNH | 87492892 | A-87492889 |
| CNH | 87492898 | A-87492892 |
| CNH | 87528620 | A-87492898 |
| CNH | 87535206 | A-87528620 |
| CNH | 87542623 | A-87535206 |
| CNH | 87546477 | A-87542623 |
| CNH | 87546926 | A-87546477 |
| CNH | 87559043 | A-87546926 |
| CNH | 87561763 | A-87559043 |
| CNH | 87566356 | A-87561763 |
| CNH | 87567251 | A-87566356 |
| CNH | 87590392 | A-87567251 |
| CNH | 87604563 | A-87590392 |
| CNH | 87605390 | A-87604563 |
| CNH | 87611875 | A-87605390 |
| CNH | 87615555 | A-87611875 |
| CNH | 87618427 | A-87615555 |
| CNH | 87646697 | A-87618427 |
| CNH | 87673681 | A-87646697 |
| CNH | 87681147 | A-87673681 |
| CNH | 87685981 | A-87681147 |
| CNH | 87697425 | A-87685981 |
| CNH | 87705866 | A-87697425 |
| CNH | 87709228 | A-87705866 |
| CNH | 87713059 | A-87709228 |



CASE NEW HOLLAND (CNH)

| OEM | OEM  Part No. | PIX  Part No. |
|-----|--|--|
| CNH | 87713097 | A-87713059 |
| CNH | 87743183 | A-87713097 |
| CNH | 87746757 | A-87743183 |
| CNH | 8818153 | A-87746757 |
| CNH | 8819672 | A-8818153 |
| CNH | 89434160 | A-8819672 |
| CNH | 89501863 | A-89434160 |
| CNH | 89504548 | A-89501863 |
| CNH | 89506463 | A-89504548 |
| CNH | 89513386 | A-89506463 |
| CNH | 89514989 | A-89513386 |
| CNH | 89514990 | A-89514989 |
| CNH | 89575153 | A-89514990 |
| CNH | 89811150 | A-89575153 |
| CNH | 89811151 | A-89811150 |
| CNH | 89815437 | A-89811151 |
| CNH | 89817250 | A-89815437 |
| CNH | 89817439 | A-89817250 |
| CNH | 89817548 | A-89817439 |
| CNH | 89817814 | A-89817548 |
| CNH | 89819676 | A-89817814 |
| CNH | 89831695 | A-89819676 |
| CNH | 89831702 | A-89831695 |
| CNH | 89831729 | A-89831702 |
| CNH | 89831731 | A-89831729 |
| CNH | 89831733 | A-89831731 |
| CNH | 89831735 | A-89831733 |
| CNH | 89831737 | A-89831735 |
| CNH | 89831740 | A-89831737 |
| CNH | 89831741 | A-89831740 |
| CNH | 89831742 | A-89831741 |
| CNH | 89835429 | A-89831742 |
| CNH | 89835815 | A-89835429 |
| CNH | 89842660 | A-89835815 |
| CNH | 89850782 | A-89842660 |
| CNH | 903650T1 | A-89850782 |
| CNH | 905529 | A-90-3650T1 |
| CNH | 9131519 | A-905529 |
| CNH | 9131533 | A-9131519 |
| CNH | 919681 | A-9131533 |
| CNH | 920012988 | A-919681 |
| CNH | 920016253 | A-920012988 |
| CNH | 920016255 | A-920016253 |
| CNH | 920018706 | A-920016255 |
| CNH | 920018888 | A-920018706 |
| CNH | 920018889 | A-920018888 |
| CNH | 920019295 | A-920018889 |

| OEM | OEM  Part No. | PIX  Part No. |
|-----|--|--|
| CNH | 920019497 | A-920019295 |
| CNH | 920019570 | A-920019497 |
| CNH | 920019588 | A-920019570 |
| CNH | 922872 | A-920019588 |
| CNH | 9228728 | A-922872 |
| CNH | 9230191 | A-9228728 |
| CNH | 935951R1 | A-9230191 |
| CNH | 942231C1 | A-935951R1 |
| CNH | 944028926 | A-942231C1 |
| CNH | 944032610 | A-944028926 |
| CNH | 95011824 | A-944032610 |
| CNH | 953962C2 | A-95011824 |
| CNH | 9579546 | A-953962C2 |
| CNH | 9600753 | A-9579546 |
| CNH | 9601139 | A-9600753 |
| CNH | 9601666.00 | A-9601139 |
| CNH | 9601699 | A-9601666 |
| CNH | 9607568 | A-9601699 |
| CNH | 9611904 | A-9607568 |
| CNH | 9611905 | A-9611904 |
| CNH | 9612039 | A-9611905 |
| CNH | 9612805 | A-9612039 |
| CNH | 9613719 | A-9612805 |
| CNH | 9613721 | A-9613719 |
| CNH | 9613723 | A-9613721 |
| CNH | 9613724 | A-9613723 |
| CNH | 9613727 | A-9613724 |
| CNH | 9613728 | A-9613727 |
| CNH | 9616745 | A-9613728 |
| CNH | 9622032 | A-9616745 |
| CNH | 9624507 | A-9622032 |
| CNH | 9625879 | A-9624507 |
| CNH | 9636395 | A-9625879 |
| CNH | 9636667 | A-9636395 |
| CNH | 9637348 | A-9636667 |
| CNH | 9671704 | A-9637348 |
| CNH | 9672186 | A-9671704 |
| CNH | 9672187 | A-9672186 |
| CNH | 9672189 | A-9672187 |
| CNH | 9672190 | A-9672189 |
| CNH | 9672191 | A-9672190 |
| CNH | 9672193 | A-9672191 |
| CNH | 9672194 | A-9672193 |
| CNH | 9672207 | A-9672194 |
| CNH | 9672208 | A-9672207 |
| CNH | 9672210 | A-9672208 |
| CNH | 9672211 | A-9672210 |

CASE NEW HOLLAND (CNH)

| OEM | OEM  Part No. | PIX  Part No. |
|-----|--|--|
| CNH | 9672212 | A-9672211 |
| CNH | 9672216 | A-9672212 |
| CNH | 9672221 | A-9672216 |
| CNH | 9707244 | A-9672221 |
| CNH | 9807449 | A-9707244 |
| CNH | 9811479 | A-9807449 |
| CNH | 9811480 | A-9811479 |
| CNH | 9817249 | A-9811480 |
| CNH | 9820480 | A-9817249 |
| CNH | 9828695 | A-9820480 |
| CNH | 9829167 | A-9828695 |
| CNH | 9831515 | A-9829167 |
| CNH | 9838606 | A-9831515 |
| CNH | 98408533 | A-9838606 |
| CNH | 98424142 | A-98408533 |
| CNH | 9842808 | A-98424142 |
| CNH | 98433148 | A-9842808 |
| CNH | 98454854 | A-98433148 |
| CNH | 98454857 | A-98454854 |
| CNH | 98454864 | A-98454857 |
| CNH | 9845513 | A-98454864 |
| CNH | 98465813 | A-9845513 |
| CNH | 98473706 | A-98465813 |
| CNH | 98473747 | A-98473706 |
| CNH | 98473922 | A-98473747 |
| CNH | 98490936 | A-98473922 |
| CNH | 9849524 | A-98490936 |
| CNH | 9850321 | A-9849524 |
| CNH | 9850782 | A-9850321 |
| CNH | 990606631005 | A-9850782 |
| CNH | 990607383023 | A-990606631005 |
| CNH | 990607398023 | A-990607383023 |
| CNH | 99439812 | A-990607398023 |
| CNH | A26660 | A-99439812 |
| CNH | A38824 | A-A26660 |
| CNH | AUB161355 | A-A38824 |
| CNH | C22707 | A-AUB161355 |
| CNH | C25686 | A-C22707 |
| CNH | CUR825343 | A-C25686 |
| CNH | D129916 | A-CUR825343 |
| CNH | D2NN8620A | A-D129916 |
| CNH | D3NN8620B | A-D2NN8620A |
| CNH | D6NN8260A | A-D3NN8620B |
| CNH | D6NN8620B | A-D6NN8260A |
| CNH | D80856 | A-D6NN8620B |
| CNH | D80857 | A-D80856 |
| CNH | Df069791 | A-D80857 |

| OEM | OEM  Part No. | PIX  Part No. |
|-----|--|--|
| CNH | Df070542 | A-DF069791 |
| CNH | Df091572 | A-DF070542 |
| CNH | E62228 | A-DF091572 |
| CNH | E7NN10C318AA | A-E62228 |
| CNH | F10280 | A-E7NN10C318AA |
| CNH | F13541 | A-F10280 |
| CNH | F13799 | A-F13541 |
| CNH | F13800 | A-F13799 |
| CNH | F14857 | A-F13800 |
| CNH | F16745 | A-F14857 |
| CNH | F16867 | A-F16745 |
| CNH | F17082 | A-F16867 |
| CNH | F17445 | A-F17082 |
| CNH | F17460 | A-F17445 |
| CNH | F18303 | A-F17460 |
| CNH | F18661 | A-F18303 |
| CNH | F18662 | A-F18661 |
| CNH | F19498 | A-F18662 |
| CNH | F19939 | A-F19498 |
| CNH | F20061 | A-F19939 |
| CNH | F20854 | A-F20061 |
| CNH | F21990 | A-F20854 |
| CNH | F22398 | A-F21990 |
| CNH | F22765 | A-F22398 |
| CNH | F22821 | A-F22765 |
| CNH | F23028 | A-F22821 |
| CNH | F7868 | A-F23028 |
| CNH | F8047 | A-F7868 |
| CNH | F9587 | A-F8047 |
| CNH | F9935 | A-F9587 |
| CNH | Fh056325 | A-F9935 |
| CNH | G46083 | A-FH056325 |
| CNH | G46234 | A-G46083 |
| CNH | Gi576772 | A-G46234 |
| CNH | H429357 | A-GI576772 |
| CNH | H437092 | A-H429357 |
| CNH | H438262 | A-H437092 |
| CNH | J903090 | A-H438262 |
| CNH | J911558 | A-J903090 |
| CNH | J911568 | A-J911558 |
| CNH | J911569 | A-J911568 |
| CNH | J911570 | A-J911569 |
| CNH | J911575 | A-J911570 |
| CNH | J911577 | A-J911575 |
| CNH | J911578 | A-J911577 |
| CNH | J911584 | A-J911578 |
| CNH | J911671 | A-J911584 |





CASE NEW HOLLAND (CNH)

| OEM | OEM Part No. | PIX Part No. |
|-----|--------------|----------------|
| CNH | J921603 | A-J911671 |
| CNH | K306655 | A-J921603 |
| CNH | K307429 | A-K306655 |
| CNH | K952514 | A-K307429 |
| CNH | L11111 | A-K952514 |
| CNH | L11705 | A-L11111 |
| CNH | L49006 | A-L11705 |
| CNH | M'42292 | A-L49006 |
| CNH | Mh014386 | A-MA-42292 |
| CNH | S202900 | A-MH014386 |
| CNH | Va0591042054 | A-S202900 |
| CNH | Va3134812101 | A-VA0591042054 |
| CNH | Va3434904400 | A-VA3134812101 |
| CNH | Vi1136712820 | A-VA3434904400 |
| CNH | Vi1136712830 | A-VI1136712820 |
| CNH | Vi8972322520 | A-VI1136712830 |
| CNH | YN20M01282D2 | A-VI8972322520 |
| CNH | YN20M01282D4 | A-YN20M01282D2 |
| CNH | YN20M01414D2 | A-YN20M01282D4 |
| CNH | YN20M01414D5 | A-YN20M01414D2 |
| CNH | YX20M01025P1 | A-YN20M01414D5 |
| CNH | Z938744 | A-YX20M01025P1 |
| CNH | Z938767 | A-Z938744 |
| CNH | 0.061361 | A-Z938767 |
| CNH | 80785415 | A-80785415 |
| CNH | 84522809 | A-84522809 |
| CNH | 86514534 | A-86514534 |



CLAAS



| OEM | OEM Part No. | PIX Part No. |
|-------|--------------|--------------|
| CLAAS | 0011035850 | A-0011035850 |
| CLAAS | 0067289.0 | A-0067289.0 |
| CLAAS | 008952.1 | A-008952.1 |
| CLAAS | 20344 | A-020344.0 |
| CLAAS | 020345.0 | A-020345.0 |
| CLAAS | 020600.0 | A-020600.0 |
| CLAAS | 20601 | A-020601.0 |
| CLAAS | 0223.4343 | A-0223.4343 |
| CLAAS | 023999.0 | A-023999.0 |
| CLAAS | 0423318 | A-0423318 |
| CLAAS | 0495067.0 | A-0495067.0 |
| CLAAS | 50090 | A-050090.0 |
| CLAAS | 51689 | A-051689.0 |
| CLAAS | 052393.1 | A-052393.1 |
| CLAAS | 055292.0 | A-055292.0 |
| CLAAS | 055893.0 | A-055893.0 |
| CLAAS | 60162 | A-060162.0 |
| CLAAS | 60239.1 | A-060239.1 |
| CLAAS | 060304.1 | A-060304.1 |
| CLAAS | 60306.4 | A-060306.4 |
| CLAAS | 060916.0 | A-060916.0 |
| CLAAS | 061204.0 | A-061204.0 |
| CLAAS | 061253.1 | A-061253.1 |
| CLAAS | 061306.0 | A-061306.0 |
| CLAAS | 061361.1 | A-061361.1 |
| CLAAS | 061872.1 | A-061872.1 |
| CLAAS | 64874 | A-064874.0 |
| CLAAS | 067290.0 | A-067290.0 |
| CLAAS | 067745.0 | A-067745.0 |
| CLAAS | 067746.0 | A-067746.0 |
| CLAAS | 067747.1 | A-067747.1 |
| CLAAS | 067789.0 | A-067789.0 |
| CLAAS | 68752 | A-068752.0 |
| CLAAS | 68752.1 | A-068752.1 |
| CLAAS | 68786 | A-068786.0 |
| CLAAS | 69925 | A-069925.0 |
| CLAAS | 070052.0 | A-070052.0 |
| CLAAS | 0743910.0 | A-0743910.0 |
| CLAAS | 074771.0 | A-074771.0 |
| CLAAS | 074771.2 | A-074771.2 |
| CLAAS | 076401.0 | A-076401.0 |
| CLAAS | 076403.1 | A-076403.1 |
| CLAAS | 077400.0 | A-077400.0 |
| CLAAS | 77401 | A-077401.0 |
| CLAAS | 077796.0 | A-077796.0 |
| CLAAS | 077797.0 | A-077797.0 |
| CLAAS | 081648.0 | A-081648.0 |

CASE NEW HOLLAND (CNH)





| OEM | OEM  Part No. | PIX  Part No. | OEM | OEM  Part No. | PIX  Part No. |
|------------|---|---|------------|---|---|
| CLAAS | 083615.0 | A-083615.0 | CLAAS | 310939.0 | A-310939.0 |
| CLAAS | 083668.0 | A-083668.0 | CLAAS | 350340.0 | A-350340.0 |
| CLAAS | 083668.1 | A-083668.1 | CLAAS | 350462.0 | A-350462.0 |
| CLAAS | 090255.0 | A-090255.0 | CLAAS | 350462.0 | A-350462.0 |
| CLAAS | 090256.0 | A-090256.0 | CLAAS | 350517.0 | A-350517.0 |
| CLAAS | 090256.1 | A-090256.1 | CLAAS | 353706.0 | A-353706.0 |
| CLAAS | 094046.1 | A-094046.1 | CLAAS | 495067.1 | A-495067.1 |
| CLAAS | 094046.2 | A-094046.2 | CLAAS | 500273.1 | A-500273.1 |
| CLAAS | 0987883.0 | A-0987883.0 | CLAAS | 500867.0 | A-500867.0 |
| CLAAS | 103735.0 | A-103735.0 | CLAAS | 500868.0 | A-500868.0 |
| CLAAS | 104098.1 | A-104098.1 | CLAAS | 501770.0 | A-501770.0 |
| CLAAS | 104237.1 | A-104237.1 | CLAAS | 501771.0 | A-501771.0 |
| CLAAS | 104497 | A-104497.0 | CLAAS | 501802.0 | A-501802.0 |
| CLAAS | 104914 | A-104914.0 | CLAAS | 501903.0 | A-501903.0 |
| CLAAS | 104990 | A-104990.0 | CLAAS | 503459 | A-503459.0 |
| CLAAS | 105580.0 | A-105580.0 | CLAAS | 503969.0 | A-503969.0 |
| CLAAS | 105603.0 | A-105603.0 | CLAAS | 503969.0 | A-503969.0 |
| CLAAS | 105860 | A-105860.0 | CLAAS | 505022 | A-505022.0 |
| CLAAS | 105860.1 | A-105860.1 | CLAAS | 505051 | A-505051 |
| CLAAS | 145265.0 | A-145265.0 | CLAAS | 505112 | A-505112.0 |
| CLAAS | 146890.0 | A-146890.0 | CLAAS | 505113.1 | A-505113.1 |
| CLAAS | 147217.0 | A-147217.0 | CLAAS | 505143.0 | A-505143.0 |
| CLAAS | 147228.0 | A-147228.0 | CLAAS | 505143.1 | A-505143.1 |
| CLAAS | 176432.0 | A-176432.0 | CLAAS | 506792.1 | A-506792.1 |
| CLAAS | 176432.1 | A-176432.1 | CLAAS | 507020.0 | A-507020.0 |
| CLAAS | 176440.1 | A-176440.1 | CLAAS | 507100.0 | A-507100.0 |
| CLAAS | 176474.1 | A-176474.1 | CLAAS | 507278.0 | A-507278.0 |
| CLAAS | 176475.0 | A-176475.0 | CLAAS | 507317 | A-507317.0 |
| CLAAS | 176542.1 | A-176542.1 | CLAAS | 507317.1 | A-507317.1 |
| CLAAS | 176544.0 | A-176544.0 | CLAAS | 507508.0 | A-507508.0 |
| CLAAS | 181501.0 | A-181501.0 | CLAAS | 507626.0 | A-507626.0 |
| CLAAS | 207050 | A-207050 | CLAAS | 507723.0 | A-507723.0 |
| CLAAS | 207060 | A-207060 | CLAAS | 507908.0 | A-507908.0 |
| CLAAS | 207080 | A-207080 | CLAAS | 509035 | A-509035.0 |
| CLAAS | 207120 | A-207120 | CLAAS | 509206 | A-509206.0 |
| CLAAS | 208200 | A-208200 | CLAAS | 512087.0 | A-512087.0 |
| CLAAS | 211148.1 | A-211148.1 | CLAAS | 519836 | A-519836 |
| CLAAS | 211240.0 | A-211240.0 | CLAAS | 528305.0 | A-528305.0 |
| CLAAS | 212759.0 | A-212759.0 | CLAAS | 532011.1 | A-532011.1 |
| CLAAS | 225850 | A-225850 | CLAAS | 544114.0 | A-544114.0 |
| CLAAS | 233525 | A-233525.0 | CLAAS | 544115.0 | A-544115.0 |
| CLAAS | 2338391 | A-2338391 | CLAAS | 544216.1 | A-544216.1 |
| CLAAS | 2338392 | A-2338392 | CLAAS | 545307.0 | A-545307.0 |
| CLAAS | 233943.1 | A-233943.1 | CLAAS | 549151.0 | A-549151.0 |
| CLAAS | 2339831 | A-2339831 | CLAAS | 549238.0 | A-549238.0 |
| CLAAS | 252420 | A-252420 | CLAAS | 549752.1 | A-549752.1 |
| CLAAS | 261545.0 | A-261545.0 | CLAAS | 5540160 | A-5540160 |

CASE NEW HOLLAND (CNH)



| OEM | OEM  Part No. | PIX  Part No. |
|------------|---|---|
| CLAAS | 554086.0 | A-554086.0 |
| CLAAS | 5540860 | A-5540860 |
| CLAAS | 554172.0 | A-554172.0 |
| CLAAS | 554186.0 | A-554186.0 |
| CLAAS | 5541860 | A-5541860 |
| CLAAS | 554269.0 | A-554269.0 |
| CLAAS | 554339.0 | A-554339.0 |
| CLAAS | 5543650 | A-5543650 |
| CLAAS | 560690.0 | A-560690.0 |
| CLAAS | 566108.0 | A-566108.0 |
| CLAAS | 567824.0 | A-567824.0 |
| CLAAS | 567825.0 | A-567825.0 |
| CLAAS | 569528.0 | A-569528.0 |
| CLAAS | 570195.0 | A-570195.0 |
| CLAAS | 570195.1 | A-570195.1 |
| CLAAS | 5701950 | A-5701950 |
| CLAAS | 570407.0 | A-570407.0 |
| CLAAS | 570407.1 | A-570407.1 |
| CLAAS | 570827.0 | A-570827.0 |
| CLAAS | 570827.1 | A-570827.1 |
| CLAAS | 572150.0 | A-572150.0 |
| CLAAS | 573443 | A-573443.0 |
| CLAAS | 573443.1 | A-573443.1 |
| CLAAS | 577100.0 | A-577100.0 |
| CLAAS | 577101.0 | A-577101.0 |
| CLAAS | 577720.0 | A-577720.0 |
| CLAAS | 577720.1 | A-577720.1 |
| CLAAS | 577721.0 | A-577721.0 |
| CLAAS | 578331.0 | A-578331.0 |
| CLAAS | 578332.0 | A-578332.0 |
| CLAAS | 580166.0 | A-580166.0 |
| CLAAS | 583940 | A-583940 |
| CLAAS | 603013.1 | A-603013.1 |
| CLAAS | 603063 | A-603063 |
| CLAAS | 609491 | A-609491 |
| CLAAS | 60954 | A-60954 |
| CLAAS | 609726 | A-609726 |
| CLAAS | 610144.0 | A-610144.0 |
| CLAAS | 610152.1 | A-610152.1 |
| CLAAS | 610833.1 | A-610833.1 |
| CLAAS | 61252 | A-61252 |
| CLAAS | 612531 | A-612531 |
| CLAAS | 617309.2 | A-617309.2 |
| CLAAS | 618720 | A-618720 |
| CLAAS | 622156.0 | A-622156.0 |
| CLAAS | 622156.1 | A-622156.1 |
| CLAAS | 623252.0 | A-623252.0 |



| OEM | OEM  Part No. | PIX  Part No. |
|------------|---|---|
| CLAAS | 623425.0 | A-623425.0 |
| CLAAS | 628175 | A-628175.0 |
| CLAAS | 628533.0 | A-628533.0 |
| CLAAS | 628579.1 | A-628579.1 |
| CLAAS | 628779.1 | A-628779.1 |
| CLAAS | 628780.0 | A-628780.0 |
| CLAAS | 628782.0 | A-628782.0 |
| CLAAS | 628784.0 | A-628784.0 |
| CLAAS | 628785.0 | A-628785.0 |
| CLAAS | 628787.0 | A-628787.0 |
| CLAAS | 628788.0 | A-628788.0 |
| CLAAS | 628791.0 | A-628791.0 |
| CLAAS | 628981 | A-628981.0 |
| CLAAS | 629081.1 | A-629081.1 |
| CLAAS | 629133.0 | A-629133.0 |
| CLAAS | 629133.1 | A-629133.1 |
| CLAAS | 629410.1 | A-629410.1 |
| CLAAS | 629441.1 | A-629441.1 |
| CLAAS | 629445.0 | A-629445.0 |
| CLAAS | 629580.1 | A-629580.1 |
| CLAAS | 629836.1 | A-629836.1 |
| CLAAS | 630011.0 | A-630011.0 |
| CLAAS | 630118.0 | A-630118.0 |
| CLAAS | 630169.0 | A-630169.0 |
| CLAAS | 634019.2 | A-634019.2 |
| CLAAS | 634046.0 | A-634046.0 |
| CLAAS | 6354270 | A-6354270 |
| CLAAS | 635940 | A-635940 |
| CLAAS | 638037.1 | A-638037.1 |
| CLAAS | 639226.2 | A-639226.2 |
| CLAAS | 639373.0 | A-639373.0 |
| CLAAS | 639417 | A-639417.0 |
| CLAAS | 644209.2 | A-644209.2 |
| CLAAS | 644368.1 | A-644368.1 |
| CLAAS | 644369.1 | A-644369.1 |
| CLAAS | 644391.0 | A-644391.0 |
| CLAAS | 644405.2 | A-644405.2 |
| CLAAS | 644419.1 | A-644419.1 |
| CLAAS | 644509 | A-644509.0 |
| CLAAS | 644514.0 | A-644514.0 |
| CLAAS | 644781.1 | A-644781.1 |
| CLAAS | 644891.0 | A-644891.0 |
| CLAAS | 644893.0 | A-644893.0 |
| CLAAS | 644894.0 | A-644894.0 |
| CLAAS | 644895.0 | A-644895.0 |
| CLAAS | 644896.0 | A-644896.0 |
| CLAAS | 644897.0 | A-644897.0 |

CASE NEW HOLLAND (CNH)



| OEM | OEM  Part No. | PIX  Part No. | OEM | OEM  Part No. | PIX  Part No. |
|-------|--|--|-------|--|--|
| CLAAS | 644898.0 | A-644898.0 | CLAAS | 673639.1 | A-673639.1 |
| CLAAS | 644899 | A-644899.0 | CLAAS | 673690.1 | A-673690.1 |
| CLAAS | 644927.0 | A-644927.0 | CLAAS | 701344 | A-701344 |
| CLAAS | 644928.1 | A-644928.1 | CLAAS | 707001.1 | A-707001.1 |
| CLAAS | 644969.0 | A-644969.0 | CLAAS | 712419.0 | A-712419.0 |
| CLAAS | 660315.0 | A-660315.0 | CLAAS | 7124192 | A-7124192 |
| CLAAS | 660316.0 | A-660316.0 | CLAAS | 720607 | A-720607.1 |
| CLAAS | 660382.0 | A-660382.0 | CLAAS | 720607.1 | A-720607.1 |
| CLAAS | 660423.0 | A-660423.0 | CLAAS | 721211.0 | A-721211.0 |
| CLAAS | 660504 | A-660504 | CLAAS | 721295.0 | A-721295.0 |
| CLAAS | 6605040 | A-6605040 | CLAAS | 722107.0 | A-722107.0 |
| CLAAS | 660566.0 | A-660566.0 | CLAAS | 724043.0 | A-724043.0 |
| CLAAS | 660568.0 | A-660568.0 | CLAAS | 7241 | A-7241 |
| CLAAS | 660587.0 | A-660587.0 | CLAAS | 724193.0 | A-724193.0 |
| CLAAS | 661031.2 | A-661031.2 | CLAAS | 724301.1 | A-724301.1 |
| CLAAS | 661128.0 | A-661128.0 | CLAAS | 733308 | A-733308.0 |
| CLAAS | 661301.1 | A-661301.1 | CLAAS | 733309.0 | A-733309.0 |
| CLAAS | 661337.1 | A-661337.1 | CLAAS | 733311 | A-733311.0 |
| CLAAS | 661361 | A-661361.0 | CLAAS | 733361.0 | A-733361.0 |
| CLAAS | 6613622 | A-6613622 | CLAAS | 742023.0 | A-742023.0 |
| CLAAS | 661378.2 | A-661378.2 | CLAAS | 742024.0 | A-742024.0 |
| CLAAS | 661435 | A-661435.0 | CLAAS | 742026.1 | A-742026.1 |
| CLAAS | 661469 | A-661469.0 | CLAAS | 742027 | A-742027.0 |
| CLAAS | 663093.0 | A-663093.0 | CLAAS | 742028.0 | A-742028.0 |
| CLAAS | 664017 | A-664017.0 | CLAAS | 742030 | A-742030.0 |
| CLAAS | 667219.0 | A-667219.0 | CLAAS | 742131.1 | A-742131.1 |
| CLAAS | 667245 | A-667245.0 | CLAAS | 742143 | A-742143.0 |
| CLAAS | 667246 | A-667246.0 | CLAAS | 742162.0 | A-742162.0 |
| CLAAS | 667253.0 | A-667253.0 | CLAAS | 742182.0 | A-742182.0 |
| CLAAS | 667256.0 | A-667256.0 | CLAAS | 742206.0 | A-742206.0 |
| CLAAS | 667454.1 | A-667454.1 | CLAAS | 744833.0 | A-744833.0 |
| CLAAS | 667511 | A-667511.0 | CLAAS | 744833.1 | A-744833.1 |
| CLAAS | 667551.2 | A-667551.2 | CLAAS | 744913 | A-744913.0 |
| CLAAS | 667682.0 | A-667682.0 | CLAAS | 745025.0 | A-745025.0 |
| CLAAS | 667788.0 | A-667788.0 | CLAAS | 746505.0 | A-746505.0 |
| CLAAS | 667798 | A-667798.0 | CLAAS | 746507.0 | A-746507.0 |
| CLAAS | 667798.1 | A-667798.1 | CLAAS | 746508.3 | A-746508.3 |
| CLAAS | 667845 | A-667845.0 | CLAAS | 746509 | A-746509 |
| CLAAS | 667846 | A-667846.0 | CLAAS | 747508.0 | A-747508.0 |
| CLAAS | 667858.0 | A-667858.0 | CLAAS | 749701.0 | A-749701.0 |
| CLAAS | 667958.1 | A-667958.1 | CLAAS | 749813.0 | A-749813.0 |
| CLAAS | 6679583 | A-6679583 | CLAAS | 749817 | A-749817.0 |
| CLAAS | 667981.0 | A-667981.0 | CLAAS | 749819.0 | A-749819.0 |
| CLAAS | 667981.1 | A-667981.1 | CLAAS | 7498240 | A-7498240 |
| CLAAS | 668619.0 | A-668619.0 | CLAAS | 749914 | A-749914.0 |
| CLAAS | 672350.1 | A-672350.1 | CLAAS | 750192 | A-750192.0 |
| CLAAS | 672359.1 | A-672359.1 | CLAAS | 750193.1 | A-750193.1 |



CASE NEW HOLLAND (CNH)

| OEM | OEM  Part No. | PIX  Part No. |
|-------|--|--|
| CLAAS | 750284.0 | A-750284.0 |
| CLAAS | 750288.1 | A-750288.1 |
| CLAAS | 750295.0 | A-750295.0 |
| CLAAS | 750316.0 | A-750316.0 |
| CLAAS | 750382.0 | A-750382.0 |
| CLAAS | 750382.1 | A-750382.1 |
| CLAAS | 750382.2 | A-750382.2 |
| CLAAS | 750451.0 | A-750451.0 |
| CLAAS | 750779 | A-750779.0 |
| CLAAS | 750888.0 | A-750888.0 |
| CLAAS | 755070.2 | A-755070.2 |
| CLAAS | 756446.0 | A-756446.0 |
| CLAAS | 756474.0 | A-756474.0 |
| CLAAS | 758622 | A-758622 |
| CLAAS | 758729 | A-758729 |
| CLAAS | 760869.0 | A-760869.0 |
| CLAAS | 760870.0 | A-760870.0 |
| CLAAS | 760870.1 | A-760870.1 |
| CLAAS | 761412.0 | A-761412.0 |
| CLAAS | 768125.0 | A-768125.0 |
| CLAAS | 769005 | A-769005.0 |
| CLAAS | 7700035746 | A-7700035746 |
| CLAAS | 7700037114 | A-7700037114 |
| CLAAS | 7700037116 | A-7700037116 |
| CLAAS | 7700043752 | A-7700043752 |
| CLAAS | 7700048822 | A-7700048822 |
| CLAAS | 7700050889 | A-7700050889 |
| CLAAS | 7700057145 | A-7700057145 |
| CLAAS | 7700059172 | A-7700059172 |
| CLAAS | 7700062256 | A-7700062256 |
| CLAAS | 7700062485 | A-7700062485 |
| CLAAS | 7700066453 | A-7700066453 |
| CLAAS | 7700066699 | A-7700066699 |
| CLAAS | 7700066725 | A-7700066725 |
| CLAAS | 770718 | A-770718.0 |
| CLAAS | 772647.1 | A-772647.1 |
| CLAAS | 772657.1 | A-772657.1 |
| CLAAS | 772659.0 | A-772659.0 |
| CLAAS | 775049.0 | A-775049.0 |
| CLAAS | 781038 | A-781038.0 |
| CLAAS | 781047.0 | A-781047.0 |
| CLAAS | 781394.0 | A-781394.0 |
| CLAAS | 781399 | A-781399.0 |
| CLAAS | 781400 | A-781400.0 |
| CLAAS | 783429 | A-783429.0 |
| CLAAS | 783430.0 | A-783430.0 |
| CLAAS | 783896 | A-783896 |



| OEM | OEM  Part No. | PIX  Part No. |
|-------|--|--|
| CLAAS | 785168.2 | A-785168.2 |
| CLAAS | 785169.0 | A-785169.0 |
| CLAAS | 785170 | A-785170.0 |
| CLAAS | 785172 | A-785172 |
| CLAAS | 785172.1 | A-785172.1 |
| CLAAS | 785173.0 | A-785173.0 |
| CLAAS | 785174.1 | A-785174.1 |
| CLAAS | 785175 | A-785175.0 |
| CLAAS | 790461.0 | A-790461.0 |
| CLAAS | 790502 | A-790502.0 |
| CLAAS | 791307.0 | A-791307.0 |
| CLAAS | 796343.0 | A-796343.0 |
| CLAAS | 796344.0 | A-796344.0 |
| CLAAS | 798779.0 | A-798779.0 |
| CLAAS | 800306 | A-800306.0 |
| CLAAS | 801491.0 | A-801491.0 |
| CLAAS | 801680 | A-801680.0 |
| CLAAS | 802530 | A-802530.0 |
| CLAAS | 808761 | A-808761.0 |
| CLAAS | 821249.0 | A-821249.0 |
| CLAAS | 821734.0 | A-821734.0 |
| CLAAS | 821813.0 | A-821813.0 |
| CLAAS | 825944.0 | A-825944.0 |
| CLAAS | 829080.0 | A-829080.0 |
| CLAAS | 837192.0 | A-837192.0 |
| CLAAS | 837195.0 | A-837195.0 |
| CLAAS | 837543.0 | A-837543.0 |
| CLAAS | 837546.0 | A-837546.0 |
| CLAAS | 837828.0 | A-837828.0 |
| CLAAS | 838227.0 | A-838227.0 |
| CLAAS | 895105.0 | A-895105.0 |
| CLAAS | 901573.0 | A-901573.0 |
| CLAAS | 906561.0 | A-906561.0 |
| CLAAS | 906736.0 | A-906736.0 |
| CLAAS | 906736.1 | A-906736.1 |
| CLAAS | 9067360 | A-9067360 |
| CLAAS | 9141490 | A-9141490 |
| CLAAS | 916529.0 | A-916529.0 |
| CLAAS | 916529.1 | A-916529.1 |
| CLAAS | 916532.1 | A-916532.1 |
| CLAAS | 917533.0 | A-917533.0 |
| CLAAS | 922188.0 | A-922188.0 |
| CLAAS | 927654 | A-927654.0 |
| CLAAS | 934301.0 | A-934301.0 |
| CLAAS | 934417.2 | A-934417.2 |
| CLAAS | 934418.1 | A-934418.1 |
| CLAAS | 934418.2 | A-934418.2 |

CASE NEW HOLLAND (CNH)



| OEM | OEM  Part No. | PIX  Part No. |
|-------|--|--|
| CLAAS | 934862.0 | A-934862.0 |
| CLAAS | 936409 | A-936409.0 |
| CLAAS | 936718.0 | A-936718.0 |
| CLAAS | 937031.0 | A-937031.0 |
| CLAAS | 937997.0 | A-937997.0 |
| CLAAS | 938171.0 | A-938171.0 |
| CLAAS | 938171.2 | A-938171.2 |
| CLAAS | 938486 | A-938486.0 |
| CLAAS | 938931 | A-938931.0 |
| CLAAS | 939297 | A-939297.0 |
| CLAAS | 943227.0 | A-943227.0 |
| CLAAS | 947112 | A-947112.0 |
| CLAAS | 947916.0 | A-947916.0 |
| CLAAS | 949396.0 | A-949396.0 |
| CLAAS | 949670 | A-949670.0 |
| CLAAS | 949888 | A-949888.0 |
| CLAAS | 950133 | A-950133.0 |
| CLAAS | 950327 | A-950327.0 |
| CLAAS | 950890.0 | A-950890.0 |
| CLAAS | 951003.6 | A-951003.6 |
| CLAAS | 951457.0 | A-951457.0 |
| CLAAS | 951654.0 | A-951654.0 |
| CLAAS | 951655.0 | A-951655.0 |
| CLAAS | 951889 | A-951889.0 |
| CLAAS | 951917 | A-951917.0 |
| CLAAS | 952578 | A-952578.0 |
| CLAAS | 952937 | A-952937.0 |
| CLAAS | 953002.8 | A-953002.8 |
| CLAAS | 980850.0 | A-980850.0 |
| CLAAS | 980852.0 | A-980852.0 |
| CLAAS | 980852.1 | A-980852.1 |
| CLAAS | 980853 | A-980853.0 |
| CLAAS | 981678.0 | A-981678.0 |
| CLAAS | 982376 | A-982376.0 |
| CLAAS | 982376.1 | A-982376.1 |
| CLAAS | 984885.0 | A-984885.0 |
| CLAAS | 984885.1 | A-984885.1 |
| CLAAS | 9848850 | A-9848850 |
| CLAAS | 985517.0 | A-985517.0 |
| CLAAS | 986390.0 | A-986390.0 |
| CLAAS | 986700.1 | A-986700.1 |
| CLAAS | AN1462 | A-AN1462 |
| CLAAS | 01397732 | A-01397732 |
| CLAAS | 077276.0 | A-077276.0 |
| CLAAS | 176442.1 | A-176442.1 |
| CLAAS | 500863.0 | A-500863.0 |
| CLAAS | 544164.0 | A-544164.0 |
| CLAAS | 544166.0 | A-544166.0 |
| CLAAS | 544172.0 | A-544172.0 |
| CLAAS | 549099.0 | A-549099.0 |
| CLAAS | 551068.0 | A-551068.0 |
| CLAAS | 630025.0 | A-630025.0 |
| CLAAS | 630043.0 | A-630043.0 |
| CLAAS | 630144.0 | A-630144.0 |

| OEM | OEM  Part No. | PIX  Part No. |
|-------|--|--|
| CLAAS | 636021.0 | A-636021.0 |
| CLAAS | 636021.1 | A-636021.1 |
| CLAAS | 644866.0 | A-644866.0 |
| CLAAS | 644892.0 | A-644892.0 |
| CLAAS | 644961.0 | A-644961.0 |
| CLAAS | 653059.0 | A-653059.0 |
| CLAAS | 653450.0 | A-653450.0 |
| CLAAS | 655408.0 | A-655408.0 |
| CLAAS | 667249.0 | A-667249.0 |
| CLAAS | 667251 1 | A-667251 1 |
| CLAAS | 667251.0 | A-667251.0 |
| CLAAS | 667427.0 | A-667427.0 |
| CLAAS | 667453 | A-667453 |
| CLAAS | 667456.0 | A-667456.0 |
| CLAAS | 667457.0 | A-667457.0 |
| CLAAS | 667477 | A-667477 |
| CLAAS | 667554.0 | A-667554.0 |
| CLAAS | 667651.0 | A-667651.0 |
| CLAAS | 667684.0 | A-667684.0 |
| CLAAS | 667798.2 | A-667798.2 |
| CLAAS | 667881.0 | A-667881.0 |
| CLAAS | 667891.0 | A-667891.0 |
| CLAAS | 667983.0 | A-667983.0 |
| CLAAS | 742025.0 | A-742025.0 |
| CLAAS | 779213 | A-779213 |
| CLAAS | 780419.0 | A-780419.0 |
| CLAAS | 796786.0 | A-796786.0 |
| CLAAS | 644685.1 | A-644685.1 |
| CLAAS | 023220.1 | A-023220.1 |
| CLAAS | 027287.0 | A-027287.0 |
| CLAAS | 0376823.0 | A-0376823.0 |
| CLAAS | 0376824.0 | A-0376824.0 |
| CLAAS | 0376830.1 | A-0376830.1 |
| CLAAS | 2227511.0 | A-2227511.0 |
| CLAAS | 2227643.0 | A-2227643.0 |
| CLAAS | D2227727.0 | A-D2227727.0 |
| CLAAS | 176440.0 | A-176440.0 |
| CLAAS | 325728.0 | A-325728.0 |
| CLAAS | 544216.0 | A-544216.0 |
| CLAAS | 549752.0 | A-549752.0 |
| CLAAS | 554365.0 | A-554365.0 |
| CLAAS | 628978.0 | A-628978.0 |
| CLAAS | 64474.0 | A-64474.0 |
| CLAAS | 666290.0 | A-666290.0 |
| CLAAS | 667530.0 | A-667530.0 |
| CLAAS | 667958.2 | A-667958.2 |
| CLAAS | 742026.0 | A-742026.0 |
| CLAAS | 746508.1 | A-746508.1 |
| CLAAS | 749824.0 | A-749824.0 |
| CLAAS | 765985.0 | A-765985.0 |
| CLAAS | 661427.0 | A-661427.0 |
| CLAAS | 667248.0 | A-667248.0 |
| CLAAS | 667252.0 | A-667252.0 |
| CLAAS | 749712.0 | A-749712.0 |



CASE NEW HOLLAND (CNH)

| OEM | OEM  Part No. | PIX  Part No. |
|-------|--|--|
| CLAAS | 667250.0 | A-667250.0 |
| CLAAS | 495431.0 | A-495431.0 |
| CLAAS | 538714.0 | A-538714.0 |
| CLAAS | 5444049.1 | A-5444049.1 |
| CLAAS | 545186.0 | A-545186.0 |
| CLAAS | 545186.1 | A-545186.1 |
| CLAAS | 545188.0 | A-545188.0 |
| CLAAS | 545216.0 | A-545216.0 |
| CLAAS | 545306.0 | A-545306.0 |
| CLAAS | 549011.0 | A-549011.0 |
| CLAAS | 554171.0 | A-554171.0 |
| CLAAS | 554016.0 | A-554016.0 |
| CLAAS | 554032.0 | A-554032.0 |
| CLAAS | 554087.0 | A-554087.0 |
| CLAAS | 554093.0 | A-554093.0 |
| CLAAS | 554098.1 | A-554098.1 |
| CLAAS | 554141.1 | A-554141.1 |
| CLAAS | 554171.0 | A-554171.0 |
| CLAAS | 554279.0 | A-554279.0 |
| CLAAS | 554361.0 | A-554361.0 |
| CLAAS | 56648.0 | A-56648.0 |
| CLAAS | 567824.1 | A-567824.1 |
| CLAAS | 628847.1 | A-628847.1 |
| CLAAS | 644362.0 | A-644362.0 |
| CLAAS | 644866.0 | A-644866.0 |
| CLAAS | 644889.0 | A-644889.0 |
| CLAAS | 644902.0 | A-644902.0 |
| CLAAS | 644942.0 | A-644942.0 |
| CLAAS | 644966.0 | A-644966.0 |
| CLAAS | 660569.0 | A-660569.0 |
| CLAAS | 663015.0 | A-663015.0 |
| CLAAS | 665798.0 | A-665798.0 |
| CLAAS | 665824.0 | A-665824.0 |
| CLAAS | 665999.2 | A-665999.2 |
| CLAAS | 667238.0 | A-667238.0 |
| CLAAS | 667452.1 | A-667452.1 |
| CLAAS | 667551.0 | A-667551.0 |
| CLAAS | 667680.0 | A-667680.0 |
| CLAAS | 667957.0 | A-667957.0 |
| CLAAS | 670768.1 | A-670768.1 |
| CLAAS | 744965.0 | A-744965.0 |
| CLAAS | 756466.0 | A-756466.0 |
| CLAAS | 774000 | A-774000 |
| CLAAS | 667958.3 | A-667958.3 |
| CLAAS | 0545307.0 | A-0545307.0 |
| CLAAS | 0617309.0 | A-0617309.0 |
| CLAAS | 630156.0 | A-630156.0 |
| CLAAS | 644404.0 | A-644404.0 |
| CLAAS | 653060.0 | A-653060.0 |
| CLAAS | 653063.0 | A-653063.0 |
| CLAAS | 653120.0 | A-653120.0 |
| CLAAS | 653121.0 | A-653121.0 |
| CLAAS | 653380.0 | A-653380.0 |



DEUTZ FAHR

| OEM | OEM  Part No. | PIX  Part No. |
|------------|--|--|
| DEUTZ FAHR | 06215196 | A-06215196 |
| DEUTZ FAHR | 06215199 | A-06215199 |
| DEUTZ FAHR | 06215209 | A-06215209 |
| DEUTZ FAHR | 06215213 | A-06215213 |
| DEUTZ FAHR | 06215237 | A-06215237 |
| DEUTZ FAHR | 06215250 | A-06215250 |
| DEUTZ FAHR | 06215261 | A-06215261 |
| DEUTZ FAHR | 06234476 | A-06234476 |
| DEUTZ FAHR | 06236657 | A-06236657 |
| DEUTZ FAHR | 06240268 | A-06240268 |
| DEUTZ FAHR | 06241305 | A-06241305 |
| DEUTZ FAHR | 088-002215-0.302 | A-088-002215-0.302 |
| DEUTZ FAHR | 088-002215-0.484 | A-088-002215-0.484 |
| DEUTZ FAHR | 088-002215-2.162 | A-088-002215-2.162 |
| DEUTZ FAHR | 088-002215-3.165 | A-088-002215-3.165 |
| DEUTZ FAHR | 088-002215-3.315 | A-088-002215-3.315 |
| DEUTZ FAHR | 088-002215-3.355 | A-088-002215-3.355 |
| DEUTZ FAHR | 088-002215-5.276 | A-088-002215-5.276 |
| DEUTZ FAHR | 088-002215-5.280 | A-088-002215-5.280 |
| DEUTZ FAHR | 088-007753-2.080 | A-088-007753-2.080 |
| DEUTZ FAHR | 088-007753-3.132 | A-088-007753-3.132 |
| DEUTZ FAHR | 088-007753-4.344 | A-088-007753-4.344 |
| DEUTZ FAHR | 088-007753-4.369 | A-088-007753-4.369 |
| DEUTZ FAHR | 088-007753-6.355 | A-088-007753-6.355 |
| DEUTZ FAHR | 088-007753-6.560 | A-088-007753-6.560 |
| DEUTZ FAHR | 089-000946-1.806 | A-089-000946-1.806 |
| DEUTZ FAHR | 089-000946-6.044 | A-089-000946-6.044 |
| DEUTZ FAHR | 089-000946-6.051 | A-089-000946-6.051 |
| DEUTZ FAHR | 089-000946-6.053 | A-089-000946-6.053 |
| DEUTZ FAHR | 089-000946-6.184 | A-089-000946-6.184 |
| DEUTZ FAHR | 089-000946-6.191 | A-089-000946-6.191 |
| DEUTZ FAHR | 1116.140.134.00 | A-1116.140.134.00 |
| DEUTZ FAHR | 1-1207-140-198.00 | A-1-1207-140-198.00 |
| DEUTZ FAHR | 1-1207-370-119.00 | A-1-1207-370-119.00 |
| DEUTZ FAHR | 1123.464.465.000 | A-1123.464.465.000 |
| DEUTZ FAHR | 1123.664.100.00 | A-1123.664.100.00 |
| DEUTZ FAHR | 1123.664.101.00 | A-1123.664.101.00 |
| DEUTZ FAHR | 1123.664.102.00 | A-1123.664.102.00 |
| DEUTZ FAHR | 1130.375.100.00 | A-1130.375.100.00 |
| DEUTZ FAHR | 1142913 | A-1142913 |
| DEUTZ FAHR | 1145330 | A-1145330 |
| DEUTZ FAHR | 117.5766 | A-117.5766 |
| DEUTZ FAHR | 1170.290.108.00 | A-1170.290.108.00 |
| DEUTZ FAHR | 1170.290.110.00 | A-1170.290.110.00 |
| DEUTZ FAHR | 1170.370.156.00 | A-1170.370.156.00 |
| DEUTZ FAHR | 1175.025.184.00 | A-1175.025.184.00 |
| DEUTZ FAHR | 1175.025.185.00 | A-1175.025.185.00 |
| DEUTZ FAHR | 1175.026.160.00 | A-1175.026.160.00 |
| DEUTZ FAHR | 1175.091.124.00 | A-1175.091.124.00 |
| DEUTZ FAHR | 1175.120.109.00 | A-1175.120.109.00 |
| DEUTZ FAHR | 1175.185.129.00 | A-1175.185.129.00 |
| DEUTZ FAHR | 1175.225.138.00 | A-1175.225.138.00 |
| DEUTZ FAHR | 1175.295.118.00 | A-1175.295.118.00 |
| DEUTZ FAHR | 1175.300.129.00 | A-1175.300.129.00 |
| DEUTZ FAHR | 1175.375.104.00 | A-1175.375.104.00 |



DEUTZ FAHR

| OEM | OEM  Part No. | PIX  Part No. |
|------------|--|--|
| DEUTZ FAHR | 1175.026.160.00 | A-1175.026.160.00 |
| DEUTZ FAHR | 1175.091.124.00 | A-1175.091.124.00 |
| DEUTZ FAHR | 1175.120.109.00 | A-1175.120.109.00 |
| DEUTZ FAHR | 1175.185.129.00 | A-1175.185.129.00 |
| DEUTZ FAHR | 1175.225.138.00 | A-1175.225.138.00 |
| DEUTZ FAHR | 1175.295.118.00 | A-1175.295.118.00 |
| DEUTZ FAHR | 1175.300.129.00 | A-1175.300.129.00 |
| DEUTZ FAHR | 1175.375.104.00 | A-1175.375.104.00 |
| DEUTZ FAHR | 1-2107-100-116.00 | A-1-2107-100-116.00 |
| DEUTZ FAHR | 1-2107-120-159.10 | A-1-2107-120-159.10 |
| DEUTZ FAHR | 1-2107-130-139.00 | A-1-2107-130-139.00 |
| DEUTZ FAHR | 16604333 | A-16604333 |
| DEUTZ FAHR | 223.518 | A-223.518 |
| DEUTZ FAHR | 223.5264 | A-223.5264 |
| DEUTZ FAHR | 30012900 | A-30012900 |
| DEUTZ FAHR | 3602 | A-3602 |
| DEUTZ FAHR | 43303430 | A-43303430 |
| DEUTZ FAHR | 6212835 | A-6212835 |
| DEUTZ FAHR | 6215210 | A-6215210 |
| DEUTZ FAHR | 6215252 | A-6215252 |
| DEUTZ FAHR | 6580024 | A-6580024 |
| DEUTZ FAHR | 8800.2215.6.280 | A-8800.2215.6.280 |
| DEUTZ FAHR | 8900094 | A-8900094 |
| DEUTZ FAHR | 890009461888 | A-890009461888 |
| DEUTZ FAHR | 890009466184 | A-890009466184 |
| DEUTZ FAHR | ND9081 | A-ND9081 |
| DEUTZ FAHR | 4221668165 | A-4221668165 |
| DEUTZ FAHR | 01145025 | A-01145025 |
| DEUTZ FAHR | 01145318 | A-01145318 |
| DEUTZ FAHR | 1141789 | A-1141789 |
| DEUTZ FAHR | 1145049 | A-1145049 |
| DEUTZ FAHR | 1145329 | A-1145329 |
| DEUTZ FAHR | 1145332 | A-1145332 |
| DEUTZ FAHR | 1145374 | A-1145374 |
| DEUTZ FAHR | 01139241 | A-01139241 |
| DEUTZ FAHR | 01145026 | A-01145026 |
| DEUTZ FAHR | 01145052 | A-01145052 |
| DEUTZ FAHR | 01145053 | A-01145053 |
| DEUTZ FAHR | 01145055 | A-01145055 |
| DEUTZ FAHR | 01145056 | A-01145056 |
| DEUTZ FAHR | 01145188 | A-01145188 |
| DEUTZ FAHR | 01145331 | A-01145331 |
| DEUTZ FAHR | 01145369 | A-01145369 |
| DEUTZ FAHR | 02235180 | A-02235180 |
| DEUTZ FAHR | 06212866 | A-06212866 |
| DEUTZ FAHR | 01141608 | A-01141608 |
| DEUTZ FAHR | 01141613 | A-01141613 |
| DEUTZ FAHR | 06215203 | A-06215203 |
| DEUTZ FAHR | 06215214 | A-06215214 |
| DEUTZ FAHR | 06215217 | A-06215217 |
| DEUTZ FAHR | 06215220 | A-06215220 |
| DEUTZ FAHR | 06215222 | A-06215222 |
| DEUTZ FAHR | 06215244 | A-06215244 |
| DEUTZ FAHR | 06215258 | A-06215258 |
| DEUTZ FAHR | 6215197 | A-6215197 |
| DEUTZ FAHR | 01141510 | A-01141510 |
| DEUTZ FAHR | 06215202 | A-06215202 |
| DEUTZ FAHR | 06215257 | A-06215257 |



FORTSCHRITT

| OEM | OEM  Part No. | PIX  Part No. |
|-------------|--|--|
| FORTSCHRITT | 9911861573 | A-4221668165 |
| FORTSCHRITT | 9911861532 | A-9911861573 |
| FORTSCHRITT | 9911861846 | A-9911861532 |
| FORTSCHRITT | 9911861557 | A-9911861846 |
| FORTSCHRITT | 9911861452 | A-9911861557 |
| FORTSCHRITT | 9911861821 | A-9911861452 |
| FORTSCHRITT | 4043403771 | A-9911861821 |
| FORTSCHRITT | 4129785100 | A-4043403771 |
| FORTSCHRITT | 4247040968 | A-4129785100 |
| FORTSCHRITT | 9911860396 | A-4247040968 |
| FORTSCHRITT | 4031827973 | A-9911860396 |
| FORTSCHRITT | 0.61009082 | A-4031827973 |
| FORTSCHRITT | 4032804306 | A-0.61009082 |
| FORTSCHRITT | 9911860757 | A-4032804306 |
| FORTSCHRITT | 9911860765 | A-9911860757 |
| FORTSCHRITT | 4032804291 | A-9911860765 |
| FORTSCHRITT | B9502224 | A-4032804291 |
| FORTSCHRITT | B9502232 | A-B9502224 |
| FORTSCHRITT | B9502225 | A-B9502232 |
| FORTSCHRITT | B9502025 | A-B9502225 |
| FORTSCHRITT | B9502122 | A-B9502025 |
| FORTSCHRITT | B9502134 | A-B9502122 |
| FORTSCHRITT | B9502131 | A-B9502134 |
| FORTSCHRITT | B9502209 | A-B9502131 |
| FORTSCHRITT | B9502207 | A-B9502209 |
| FORTSCHRITT | B9502210 | A-B9502207 |
| FORTSCHRITT | B9502246 | A-B9502210 |
| FORTSCHRITT | B9502260 | A-B9502246 |
| FORTSCHRITT | B9502259 | A-B9502260 |
| FORTSCHRITT | B9502120 | A-B9502259 |
| FORTSCHRITT | B9502226 | A-B9502120 |
| FORTSCHRITT | B9502265 | A-B9502226 |
| FORTSCHRITT | B9502229 | A-B9502265 |
| FORTSCHRITT | B9502247 | A-B9502229 |
| FORTSCHRITT | B9502227 | A-B9502247 |
| FORTSCHRITT | B9502261 | A-B9502227 |
| FORTSCHRITT | 4250212780 | A-B9502261 |
| FORTSCHRITT | 204711250 | A-4250212780 |
| FORTSCHRITT | 06014350 | A-204711250 |
| FORTSCHRITT | 4221121885 | A-06014350 |
| FORTSCHRITT | | A-4221121885 |





GRIMME

| OEM | OEM  Part No. | PIX  Part No. |
|--------|--|--|
| GRIMME | B95.02170 | A-B95.02170 |
| GRIMME | B95.02245 | A-B95.02245 |
| GRIMME | B95.02244 | A-B95.02244 |
| GRIMME | B95.02047 | A-B95.02047 |
| GRIMME | B9502263 | A-B9502263 |
| GRIMME | B9502262 | A-B9502262 |
| GRIMME | B9502228 | A-B9502228 |
| GRIMME | B9502223 | A-B9502223 |
| GRIMME | B9502155 | A-B9502155 |
| GRIMME | B9502004 | A-B9502004 |
| GRIMME | B9502005 | A-B9502005 |
| GRIMME | B9502006 | A-B9502006 |
| GRIMME | B9502166 | A-B9502166 |
| GRIMME | B9502158 | A-B9502158 |
| GRIMME | B9502165 | A-B9502165 |
| GRIMME | B9502167 | A-B9502167 |
| GRIMME | B9502149 | A-B9502149 |
| GRIMME | B9502152 | A-B9502152 |
| GRIMME | B9502205 | A-B9502205 |
| GRIMME | B9502241 | A-B9502241 |
| GRIMME | B9502150 | A-B9502150 |
| GRIMME | B9502162 | A-B9502162 |
| GRIMME | B9502250 | A-B9502250 |
| GRIMME | B9502114 | A-B9502114 |
| GRIMME | B9502188 | A-B9502188 |
| GRIMME | B9502193 | A-B9502193 |
| GRIMME | B9502145 | A-B9502145 |
| GRIMME | B9502208 | A-B9502208 |
| GRIMME | B9502125 | A-B9502125 |
| GRIMME | B9502116 | A-B9502116 |
| GRIMME | B9502045 | A-B9502045 |
| GRIMME | B9502171 | A-B9502171 |
| GRIMME | B9502128 | A-B9502128 |
| GRIMME | B9502070 | A-B9502070 |
| GRIMME | B9502142 | A-B9502142 |
| GRIMME | B9502126 | A-B9502126 |





HORWOOD BAGSHAW (HB)

| OEM | OEM  Part No. | PIX  Part No. |
|-----|--|--|
| HB | 10160 | A-10160 |
| HB | 13526 | A-13526 |
| HB | 530.3120P3 | A-530.3120P3 |
| HB | 10121 | A-10121 |
| HB | 530.3120P4 | A-530.3120P4 |
| HB | 530.1105 | A-530.1105 |
| HB | 530.1108 | A-530.1108 |
| HB | 530.1112 | A-530.1112 |
| HB | 530.112 | A-530.112 |
| HB | 530.1128 | A-530.1128 |
| HB | 530.1136 | A-530.1136 |
| HB | 530.114 | A-530.114 |
| HB | 530.1031 | A-530.1031 |
| HB | 530.0351 | A-530.0351 |
| HB | Cs975 | A-CS975 |
| HB | 530.1035 | A-530.1035 |
| HB | 530.1036 | A-530.1036 |
| HB | 530.1038 | A-530.1038 |
| HB | 530.1402 | A-530.1402 |
| HB | 530.1046 | A-530.1046 |
| HB | 530.1048 | A-530.1048 |
| HB | 530.1051 | A-530.1051 |
| HB | 530.053 | A-530.053 |
| HB | 530.055 | A-530.055 |
| HB | 530.1056 | A-530.1056 |
| HB | 530.1058 | A-530.1058 |
| HB | 0156910001 | A-0156910001 |
| HB | 530.106 | A-530.106 |
| HB | 530.1062 | A-530.1062 |
| HB | 530.1064 | A-530.1064 |
| HB | 530.073 | A-530.073 |
| HB | 530.1074 | A-530.1074 |
| HB | 530.1075 | A-530.1075 |
| HB | 530.1078 | A-530.1078 |
| HB | 530.018 | A-530.018 |
| HB | 530.081 | A-530.081 |
| HB | 530.1085 | A-530.1085 |
| HB | 530.1087 | A-530.1087 |
| HB | 530.1088 | A-530.1088 |
| HB | 530.109 | A-530.109 |
| HB | Cs976 | A-CS976 |
| HB | 530.1093 | A-530.1093 |
| HB | 530.0985 | A-530.0985 |
| HB | 10150 | A-10150 |
| HB | 530.0992 | A-530.0992 |
| HB | 530.1002 | A-530.1002 |
| HB | 10151 | A-10151 |





HORWOOD BAGSHAW (HB)

| OEM | OEM  Part No. | PIX  Part No. | OEM | OEM  Part No. | PIX  Part No. |
|-----|--|--|-----|--|--|
| HB | 530.1026 | A-530.1026 | HB | 530.0516 | A-530.0516 |
| HB | Cs977 | A-CS977 | HB | 10162 | A-10162 |
| HB | 10163 | A-10163 | HB | 530.2051 | A-530.2051 |
| HB | 0156910103 | A-0156910103 | HB | 10148 | A-10148 |
| HB | 10165 | A-10165 | HB | 530.0525 | A-530.0525 |
| HB | 530.2105-3 | A-530.2105-3 | HB | 530.2054 | A-530.2054 |
| HB | 0156910104 | A-0156910104 | HB | 530.2055 | A-530.2055 |
| HB | 530.2107-3 | A-530.2107-3 | HB | 10161 | A-10161 |
| HB | 530.2107 | A-530.2107 | HB | 530.06 | A-530.06 |
| HB | 530.111B2 | A-530.111B2 | HB | 10166 | A-10166 |
| HB | 530.1121 | A-530.1121 | HB | 530.206 | A-530.206 |
| HB | 530.2112 | A-530.2112 | HB | 10141 | A-10141 |
| HB | 10152 | A-10152 | HB | Cs2399 | A-CS2399 |
| HB | 530.1187 | A-530.1187 | HB | 530.2063 | A-530.2063 |
| HB | 530.1211 | A-530.1211 | HB | 0156910102 | A-0156910102 |
| HB | 530.212 | A-530.212 | HB | 13516 | A-13516 |
| HB | 530.412 | A-530.412 | HB | 530.0695 | A-530.0695 |
| HB | 530.1252 | A-530.1252 | HB | 530.2068 | A-530.2068 |
| HB | 530.2124 | A-530.2124 | HB | 530.2069 | A-530.2069 |
| HB | 530.2128 | A-530.2128 | HB | 530.207 | A-530.207 |
| HB | 530.2132 | A-530.2132 | HB | 530.0727 | A-530.0727 |
| HB | 10153 | A-10153 | HB | 530.2071 | A-530.2071 |
| HB | 530.1377 | A-530.1377 | HB | 530.2072 | A-530.2072 |
| HB | 530.2136 | A-530.2136 | HB | 10142 | A-10142 |
| HB | 530.141 | A-530.141 | HB | 10143 | A-10143 |
| HB | 0156910106 | A-0156910106 | HB | 530.0757 | A-530.0757 |
| HB | 530.1455 | A-530.1455 | HB | Cs1479 | A-CS1479 |
| HB | 530.2143 | A-530.2143 | HB | 10145 | A-10145 |
| HB | 530.2144 | A-530.2144 | HB | 530.2075 | A-530.2075 |
| HB | 530.2152 | A-530.2152 | HB | 530.0774 | A-530.0774 |
| HB | 530.216 | A-530.216 | HB | 530.2076 | A-530.2076 |
| HB | 10154 | A-10154 | HB | 530.0802 | A-530.0802 |
| HB | 530.2162 | A-530.2162 | HB | 10144 | A-10144 |
| HB | 530.1701 | A-530.1701 | HB | Cs978 | A-CS978 |
| HB | 10155 | A-10155 | HB | 530.0817 | A-530.0817 |
| HB | 530.218 | A-530.218 | HB | 530.208 | A-530.208 |
| HB | 530.221 | A-530.221 | HB | 530.2080B2 | A-530.2080B2 |
| HB | 10158 | A-10158 | HB | 530.2081 | A-530.2081 |
| HB | 530.2038 | A-530.2038 | HB | 530.0837 | A-530.0837 |
| HB | 530.204 | A-530.204 | HB | 530.2082 | A-530.2082 |
| HB | 530.0426 | A-530.0426 | HB | 530.2083 | A-530.2083 |
| HB | 10139 | A-10139 | HB | 530.2084 | A-530.2084 |
| HB | K228 | A-K228 | HB | 530.2085 | A-530.2085 |
| HB | 13515 | A-13515 | HB | 530.0881 | A-530.0881 |
| HB | 530.2044 | A-530.2044 | HB | 10147 | A-10147 |
| HB | 530.2046 | A-530.2046 | HB | 530.209 | A-530.209 |
| HB | 13487 | A-13487 | HB | 530.0913 | A-530.0913 |



HORWOOD BAGSHAW (HB)

| OEM | OEM  Part No. | PIX  Part No. | OEM | OEM  Part No. | PIX  Part No. |
|-----|--|--|-----|--|--|
| HB | 530.2093 | A-530.2093 | HB | 520.3075 | A-520.3075 |
| HB | 530.2095 | A-530.2095 | HB | 530.0775 | A-530.0775 |
| HB | 10149 | A-10149 | HB | 530.10165 | A-530.10165 |
| HB | 0156910203 | A-0156910203 | HB | 530.3075 | A-530.3075 |
| HB | 10171 | A-10171 | HB | 530.3076 | A-530.3076 |
| HB | 530.3096 | A-530.3096 | HB | 0156910202 | A-0156910202 |
| HB | 530.3099 | A-530.3099 | HB | 10168 | A-10168 |
| HB | 10173 | A-10173 | HB | 530.08 | A-530.08 |
| HB | 0156910205 | A-0156910205 | HB | 530.3078 | A-530.3078 |
| HB | 10176 | A-10176 | HB | K1148 | A-K1148 |
| HB | 530.3112 | A-530.3112 | HB | 10169 | A-10169 |
| HB | 530.3116 | A-530.3116 | HB | K2429 | A-K2429 |
| HB | 10178 | A-10178 | HB | 530.0855 | A-530.0855 |
| HB | 530.312 | A-530.312 | HB | 530.087 | A-530.087 |
| HB | 10157 | A-10157 | HB | 13530 | A-13530 |
| HB | 530.3128 | A-530.3128 | HB | 530.3085 | A-530.3085 |
| HB | 530.3132 | A-530.3132 | HB | 530.0925 | A-530.0925 |
| HB | 0156910208 | A-0156910208 | HB | 530.309 | A-530.309 |
| HB | 10180 | A-10180 | HB | 10172 | A-10172 |
| HB | 530.1465 | A-530.1465 | HB | 530.095 | A-530.095 |
| HB | 530.3144 | A-530.3144 | HB | 530.3092 | A-530.3092 |
| HB | 0156910207 | A-0156910207 | HB | 530.3093 | A-530.3093 |
| HB | 10179 | A-10179 | HB | 0185112130 | A-0185112130 |
| HB | 10183 | A-10183 | HB | 530.11213 | A-530.11213 |
| HB | 530.3152 | A-530.3152 | HB | 1651023 | A-1651023 |
| HB | 10185 | A-10185 | HB | 10186 | A-10186 |
| HB | 530.158 | A-530.158 | HB | 14051 | A-14051 |
| HB | 530.3158 | A-530.3158 | HB | 530.0186 | A-530.0186 |
| HB | K374 | A-K374 | HB | 10146 | A-10146 |
| HB | 530.1972 | A-530.1972 | HB | 10187 | A-10187 |
| HB | 530.3162 | A-530.3162 | HB | 14053 | A-14053 |
| HB | 530.318 | A-530.318 | | | |
| HB | 530.4195 | A-530.4195 | | | |
| HB | 10189 | A-10189 | | | |
| HB | 10190 | A-10190 | | | |
| HB | 10191 | A-10191 | | | |
| HB | 530.3048 | A-530.3048 | | | |
| HB | 530.0532 | A-530.0532 | | | |
| HB | 530.3051 | A-530.3051 | | | |
| HB | 530.0605 | A-530.0605 | | | |
| HB | 10182 | A-10182 | | | |
| HB | 530.062 | A-530.062 | | | |
| HB | 530.306 | A-530.306 | | | |
| HB | 530.0657 | A-530.0657 | | | |
| HB | 530.07 | A-530.07 | | | |
| HB | 530.0725 | A-530.0725 | | | |
| HB | 530.0762 | A-530.0762 | | | |



JF FABRIKEN

| OEM | OEM  Part No. | PIX  Part No. | OEM | OEM  Part No. | PIX  Part No. |
|-------------|--|--|-------------|--|--|
| JF FABRIKEN | 13621001 | A-13621001 | JF FABRIKEN | 13616102 | A-13616102 |
| JF FABRIKEN | 13621005 | A-13621005 | JF FABRIKEN | 13619737 | A-13619737 |
| JF FABRIKEN | 13621002 | A-13621002 | JF FABRIKEN | 13629713 | A-13629713 |
| JF FABRIKEN | 13621007 | A-13621007 | JF FABRIKEN | 13629730 | A-13629730 |
| JF FABRIKEN | 13621205 | A-13621205 | JF FABRIKEN | 13629732 | A-13629732 |
| JF FABRIKEN | 13629733 | A-13629733 | JF FABRIKEN | 13618110 | A-13618110 |
| JF FABRIKEN | 13621207 | A-13621207 | JF FABRIKEN | 13622405 | A-13622405 |
| JF FABRIKEN | 13621008 | A-13621008 | JF FABRIKEN | 13622407 | A-13622407 |
| JF FABRIKEN | 13629724 | A-13629724 | JF FABRIKEN | 13613404 | A-13613404 |
| JF FABRIKEN | 13629803 | A-13629803 | JF FABRIKEN | 13614401 | A-13614401 |
| JF FABRIKEN | 13621208 | A-13621208 | JF FABRIKEN | 13614402 | A-13614402 |
| JF FABRIKEN | 13621012 | A-13621012 | JF FABRIKEN | 13614403 | A-13614403 |
| JF FABRIKEN | 13621209 | A-13621209 | JF FABRIKEN | 13615402 | A-13615402 |
| JF FABRIKEN | 13622202 | A-13622202 | JF FABRIKEN | 13615404 | A-13615404 |
| JF FABRIKEN | 13619805 | A-13619805 | JF FABRIKEN | 13615405 | A-13615405 |
| JF FABRIKEN | 13629702 | A-13629702 | JF FABRIKEN | 13616406 | A-13616406 |
| JF FABRIKEN | 13629722 | A-13629722 | JF FABRIKEN | 13619901 | A-13619901 |
| JF FABRIKEN | 13629716 | A-13629716 | JF FABRIKEN | 13616407 | A-13616407 |
| JF FABRIKEN | 13622106 | A-13622106 | JF FABRIKEN | 13616402 | A-13616402 |
| JF FABRIKEN | 13629727 | A-13629727 | JF FABRIKEN | 13616410 | A-13616410 |
| JF FABRIKEN | 13629725 | A-13629725 | JF FABRIKEN | 13616404 | A-13616404 |
| JF FABRIKEN | 13619804 | A-13619804 | JF FABRIKEN | 13616405 | A-13616405 |
| JF FABRIKEN | 13619703 | A-13619703 | JF FABRIKEN | 13616401 | A-13616401 |
| JF FABRIKEN | 13629721 | A-13629721 | JF FABRIKEN | 13619908 | A-13619908 |
| JF FABRIKEN | 13629705 | A-13629705 | JF FABRIKEN | 13617403 | A-13617403 |
| JF FABRIKEN | 13623205 | A-13623205 | JF FABRIKEN | 13618403 | A-13618403 |
| JF FABRIKEN | 13621004 | A-13621004 | JF FABRIKEN | 13618401 | A-13618401 |
| JF FABRIKEN | 13613202 | A-13613202 | JF FABRIKEN | 13619906 | A-13619906 |
| JF FABRIKEN | 13623105 | A-13623105 | JF FABRIKEN | 13618307 | A-13618307 |
| JF FABRIKEN | 13614101 | A-13614101 | JF FABRIKEN | 13628408 | A-13628408 |
| JF FABRIKEN | 13629723 | A-13629723 | JF FABRIKEN | 13618308 | A-13618308 |
| JF FABRIKEN | 13619707 | A-13619707 | JF FABRIKEN | 13618311 | A-13618311 |
| JF FABRIKEN | 13621013 | A-13621013 | JF FABRIKEN | 13618310 | A-13618310 |
| JF FABRIKEN | 13621003 | A-13621003 | JF FABRIKEN | 13624105 | A-13624105 |
| JF FABRIKEN | 13621009 | A-13621009 | JF FABRIKEN | 13618303 | A-13618303 |
| JF FABRIKEN | 13615202 | A-13615202 | JF FABRIKEN | 13618304 | A-13618304 |
| JF FABRIKEN | 13621010 | A-13621010 | JF FABRIKEN | 13618300 | A-13618300 |
| JF FABRIKEN | 13621006 | A-13621006 | JF FABRIKEN | 13619615 | A-13619615 |
| JF FABRIKEN | 13626101 | A-13626101 | JF FABRIKEN | 13619601 | A-13619601 |
| JF FABRIKEN | 13621016 | A-13621016 | JF FABRIKEN | 13619605 | A-13619605 |
| JF FABRIKEN | 13621014 | A-13621014 | JF FABRIKEN | 13619608 | A-13619608 |
| JF FABRIKEN | 13629720 | A-13629720 | JF FABRIKEN | 13615502 | A-13615502 |
| JF FABRIKEN | 13621017 | A-13621017 | JF FABRIKEN | 13615501 | A-13615501 |
| JF FABRIKEN | 13619706 | A-13619706 | JF FABRIKEN | 13616501 | A-13616501 |
| JF FABRIKEN | 13621011 | A-13621011 | JF FABRIKEN | 13617502 | A-13617502 |
| JF FABRIKEN | 13619709 | A-13619709 | JF FABRIKEN | 13628505 | A-13628505 |
| JF FABRIKEN | 13629719 | A-13629719 | JF FABRIKEN | 13618509 | A-13618509 |

HORWOOD BAGSHAW (HB)



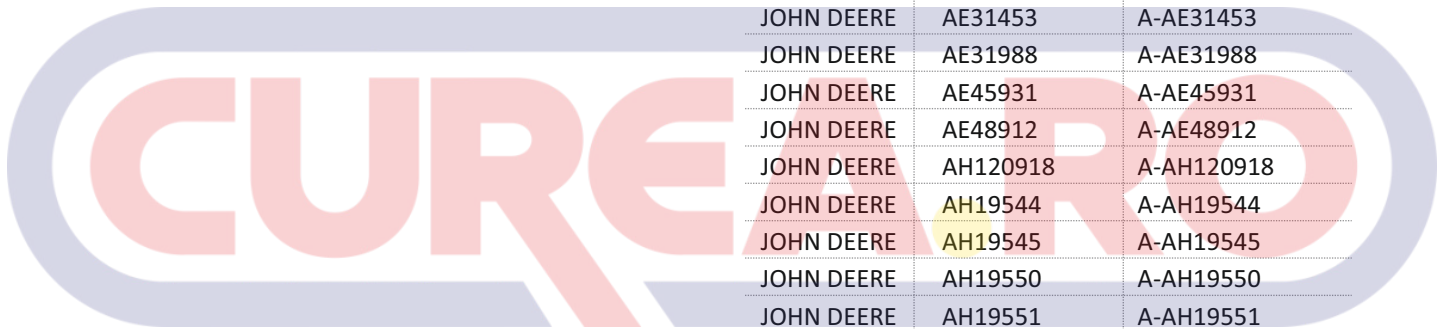

| OEM | OEM  Part No. | PIX  Part No. |
|-------------|--|--|
| JF FABRIKEN | 13618508 | A-13618508 |
| JF FABRIKEN | 13618503 | A-13618503 |
| JF FABRIKEN | 13619618 | A-13619618 |
| JF FABRIKEN | 13618511 | A-13618511 |
| JF FABRIKEN | 13618512 | A-13618512 |

JOHN DEERE





| OEM | OEM  Part No. | PIX  Part No. |
|------------|--|--|
| JOHN DEERE | 175632 | A-175632 |
| JOHN DEERE | 01145789 | A-01145789 |
| JOHN DEERE | 10VX00D | A-10VX00D |
| JOHN DEERE | 155538 | A-155538 |
| JOHN DEERE | 190040211 | A-190040211 |
| JOHN DEERE | 37473 | A-37473 |
| JOHN DEERE | 4032807792 | A-4032807792 |
| JOHN DEERE | 40745/804 | A-40745/804 |
| JOHN DEERE | 41959200 | A-41959200 |
| JOHN DEERE | 60022 | A-60022 |
| JOHN DEERE | 600A01 | A-600A01 |
| JOHN DEERE | 600A07 | A-600A07 |
| JOHN DEERE | 600A11 | A-600A11 |
| JOHN DEERE | 600A16 | A-600A16 |
| JOHN DEERE | 84012974 | A-84012974 |
| JOHN DEERE | A 121116 | A-A121116 |
| JOHN DEERE | A29343 | A-A29343 |
| JOHN DEERE | AE28944 | A-AE28944 |
| JOHN DEERE | AE31453 | A-AE31453 |
| JOHN DEERE | AE31988 | A-AE31988 |
| JOHN DEERE | AE45931 | A-AE45931 |
| JOHN DEERE | AE48912 | A-AE48912 |
| JOHN DEERE | AH120918 | A-AH120918 |
| JOHN DEERE | AH19544 | A-AH19544 |
| JOHN DEERE | AH19545 | A-AH19545 |
| JOHN DEERE | AH19550 | A-AH19550 |
| JOHN DEERE | AH19551 | A-AH19551 |
| JOHN DEERE | AH20314H | A-AH20314H |
| JOHN DEERE | AH21300 | A-AH21300 |
| JOHN DEERE | AH228935 | A-AH228935 |
| JOHN DEERE | AH232955 | A-AH232955 |
| JOHN DEERE | AH62667 | A-AH62667 |
| JOHN DEERE | AH62729 | A-AH62729 |
| JOHN DEERE | AH63075 | A-AH63075 |
| JOHN DEERE | AH75079 | A-AH75079 |
| JOHN DEERE | AH75634 | A-AH75634 |
| JOHN DEERE | AH76142 | A-AH76142 |
| JOHN DEERE | AJ58940 | A-AJ58940 |
| JOHN DEERE | AN103487 | A-AN103487 |
| JOHN DEERE | AN103488 | A-AN103488 |
| JOHN DEERE | AN150062 | A-AN150062 |
| JOHN DEERE | AN190948 | A-AN190948 |
| JOHN DEERE | AN194750 | A-AN194750 |
| JOHN DEERE | AN194751 | A-AN194751 |
| JOHN DEERE | AN194916 | A-AN194916 |
| JOHN DEERE | AN194917 | A-AN194917 |
| JOHN DEERE | AN221414 | A-AN221414 |







JOHN DEERE

| OEM | OEM  Part No. | PIX  Part No. | OEM | OEM  Part No. | PIX  Part No. |
|------------|--|--|------------|--|--|
| JOHN DEERE | AN273251 | A-AN273251 | JOHN DEERE | AZ53569 | A-AZ53569 |
| JOHN DEERE | AN273299 | A-AN273299 | JOHN DEERE | AZ53570 | A-AZ53570 |
| JOHN DEERE | AN274215 | A-AN274215 | JOHN DEERE | AZ56225 | A-AZ56225 |
| JOHN DEERE | AN274672 | A-AN274672 | JOHN DEERE | AZ58519 | A-AZ58519 |
| JOHN DEERE | AN274673 | A-AN274673 | JOHN DEERE | AZ61336 | A-AZ61336 |
| JOHN DEERE | AN373725 | A-AN373725 | JOHN DEERE | AZ61389 | A-AZ61389 |
| JOHN DEERE | AR53099 | A-AR53099 | JOHN DEERE | AZ63463 | A-AZ63463 |
| JOHN DEERE | AR57266 | A-AR57266 | JOHN DEERE | AZ63883 | A-AZ63883 |
| JOHN DEERE | AR86496 | A-AR86496 | JOHN DEERE | B13907B | A-B13907B |
| JOHN DEERE | AS22914 | A-AS22914 | JOHN DEERE | B14826B | A-B14826B |
| JOHN DEERE | AS26639 | A-AS26639 | JOHN DEERE | B17267B | A-B17267B |
| JOHN DEERE | AS33603 | A-AS33603 | JOHN DEERE | B27635 | A-B27635 |
| JOHN DEERE | AS34773 | A-AS34773 | JOHN DEERE | B28170 | A-B28170 |
| JOHN DEERE | AT23317 | A-AT23317 | JOHN DEERE | C11078C | A-C11078C |
| JOHN DEERE | AW10254 | A-AW10254 | JOHN DEERE | C12831CH | A-C12831CH |
| JOHN DEERE | AXE10456 | A-AXE10456 | JOHN DEERE | C17165 | A-C17165 |
| JOHN DEERE | AXE22550 | A-AXE22550 | JOHN DEERE | C17334 | A-C17334 |
| JOHN DEERE | AXE24473 | A-AXE24473 | JOHN DEERE | C19647 | A-C19647 |
| JOHN DEERE | AXE25334 | A-AXE25334 | JOHN DEERE | C22534 | A-C22534 |
| JOHN DEERE | AXE26321 | A-AXE26321 | JOHN DEERE | CC100317 | A-CC100317 |
| JOHN DEERE | AXE29294 | A-AXE29294 | JOHN DEERE | CC100318 | A-CC100318 |
| JOHN DEERE | AXE33418 | A-AXE33418 | JOHN DEERE | CC100752 | A-CC100752 |
| JOHN DEERE | AXE33760 | A-AXE33760 | JOHN DEERE | CC100753 | A-CC100753 |
| JOHN DEERE | AYC10131 | A-AYC10131 | JOHN DEERE | CC100754 | A-CC100754 |
| JOHN DEERE | AYC10132 | A-AYC10132 | JOHN DEERE | CC102733 | A-CC102733 |
| JOHN DEERE | AYC10133 | A-AYC10133 | JOHN DEERE | CC107199 | A-CC107199 |
| JOHN DEERE | AYC18136 | A-AYC18136 | JOHN DEERE | CC18089 | A-CC18089 |
| JOHN DEERE | AZ100806 | A-AZ100806 | JOHN DEERE | CC19065 | A-CC19065 |
| JOHN DEERE | AZ100807 | A-AZ100807 | JOHN DEERE | CC21115 | A-CC21115 |
| JOHN DEERE | AZ100808 | A-AZ100808 | JOHN DEERE | CC26949 | A-CC26949 |
| JOHN DEERE | AZ100809 | A-AZ100809 | JOHN DEERE | CC26973 | A-CC26973 |
| JOHN DEERE | AZ100810 | A-AZ100810 | JOHN DEERE | CC38627 | A-CC38627 |
| JOHN DEERE | AZ101386 | A-AZ101386 | JOHN DEERE | CC38702 | A-CC38702 |
| JOHN DEERE | AZ25400 | A-AZ25400 | JOHN DEERE | CC47554 | A-CC47554 |
| JOHN DEERE | AZ39676 | A-AZ39676 | JOHN DEERE | CH12865 | A-CH12865 |
| JOHN DEERE | AZ39677 | A-AZ39677 | JOHN DEERE | CH40793 | A-CH40793 |
| JOHN DEERE | AZ39678 | A-AZ39678 | JOHN DEERE | CM15519 | A-CM15519 |
| JOHN DEERE | AZ41136 | A-AZ41136 | JOHN DEERE | CM15520 | A-CM15520 |
| JOHN DEERE | AZ43804 | A-AZ43804 | JOHN DEERE | CQ00626 | A-CQ00626 |
| JOHN DEERE | AZ43805 | A-AZ43805 | JOHN DEERE | CQ00628 | A-CQ00628 |
| JOHN DEERE | AZ46283 | A-AZ46283 | JOHN DEERE | CQ02867 | A-CQ02867 |
| JOHN DEERE | AZ51312 | A-AZ51312 | JOHN DEERE | CQ03283 | A-CQ03283 |
| JOHN DEERE | AZ51314 | A-AZ51314 | JOHN DEERE | CQ03457 | A-CQ03457 |
| JOHN DEERE | AZ51638 | A-AZ51638 | JOHN DEERE | CQ05106 | A-CQ05106 |
| JOHN DEERE | AZ51639 | A-AZ51639 | JOHN DEERE | CQ05208 | A-CQ05208 |
| JOHN DEERE | AZ51641 | A-AZ51641 | JOHN DEERE | CQ08238 | A-CQ08238 |
| JOHN DEERE | AZ53559 | A-AZ53559 | JOHN DEERE | CQ12236 | A-CQ12236 |





JOHN DEERE

| OEM | OEM  Part No. | PIX  Part No. | OEM | OEM  Part No. | PIX  Part No. |
|------------|--|--|------------|--|--|
| JOHN DEERE | CQ13375 | A-CQ13375 | JOHN DEERE | E127010 | A-E127010 |
| JOHN DEERE | CQ13673 | A-CQ13673 | JOHN DEERE | E130084 | A-E130084 |
| JOHN DEERE | CQ13800 | A-CQ13800 | JOHN DEERE | E13664 | A-E13664 |
| JOHN DEERE | CQ24186 | A-CQ24186 | JOHN DEERE | E14507 | A-E14507 |
| JOHN DEERE | CQ24340 | A-CQ24340 | JOHN DEERE | E16774 | A-E16774 |
| JOHN DEERE | CQ33577 | A-CQ33577 | JOHN DEERE | E17465E | A-E17465E |
| JOHN DEERE | CQ33886 | A-CQ33886 | JOHN DEERE | E17844 | A-E17844 |
| JOHN DEERE | CQ34122 | A-CQ34122 | JOHN DEERE | E35829 | A-E35829 |
| JOHN DEERE | CQ34237 | A-CQ34237 | JOHN DEERE | E36311 | A-E36311 |
| JOHN DEERE | CQ35417 | A-CQ35417 | JOHN DEERE | E36784 | A-E36784 |
| JOHN DEERE | CQ35531 | A-CQ35531 | JOHN DEERE | E37644 | A-E37644 |
| JOHN DEERE | CQ35559 | A-CQ35559 | JOHN DEERE | E37821 | A-E37821 |
| JOHN DEERE | CQ40221 | A-CQ40221 | JOHN DEERE | E37905 | A-E37905 |
| JOHN DEERE | CQ45617 | A-CQ45617 | JOHN DEERE | E38587 | A-E38587 |
| JOHN DEERE | CQ48048 | A-CQ48048 | JOHN DEERE | E39526 | A-E39526 |
| JOHN DEERE | CQ50143 | A-CQ50143 | JOHN DEERE | E39739 | A-E39739 |
| JOHN DEERE | CQ50144 | A-CQ50144 | JOHN DEERE | E40574 | A-E40574 |
| JOHN DEERE | CQ51920 | A-CQ51920 | JOHN DEERE | E41055 | A-E41055 |
| JOHN DEERE | CQ51921 | A-CQ51921 | JOHN DEERE | E43565 | A-E43565 |
| JOHN DEERE | CQ53362 | A-CQ53362 | JOHN DEERE | E4461E | A-E4461E |
| JOHN DEERE | CQ53363 | A-CQ53363 | JOHN DEERE | E46113 | A-E46113 |
| JOHN DEERE | CQ53364 | A-CQ53364 | JOHN DEERE | E46806 | A-E46806 |
| JOHN DEERE | CQ53367 | A-CQ53367 | JOHN DEERE | E46844 | A-E46844 |
| JOHN DEERE | CQ53369 | A-CQ53369 | JOHN DEERE | E46847 | A-E46847 |
| JOHN DEERE | CQ53370 | A-CQ53370 | JOHN DEERE | E48060 | A-E48060 |
| JOHN DEERE | CQ53371 | A-CQ53371 | JOHN DEERE | E48063 | A-E48063 |
| JOHN DEERE | CQ53372 | A-CQ53372 | JOHN DEERE | E48310 | A-E48310 |
| JOHN DEERE | CQ57311 | A-CQ57311 | JOHN DEERE | E50237 | A-E50237 |
| JOHN DEERE | CQ58873 | A-CQ58873 | JOHN DEERE | E50873 | A-E50873 |
| JOHN DEERE | CQ58875 | A-CQ58875 | JOHN DEERE | E50924 | A-E50924 |
| JOHN DEERE | CQ62911 | A-CQ62911 | JOHN DEERE | E50973 | A-E50973 |
| JOHN DEERE | CQ62912 | A-CQ62912 | JOHN DEERE | E51284 | A-E51284 |
| JOHN DEERE | D21501 | A-D21501 | JOHN DEERE | E51727 | A-E51727 |
| JOHN DEERE | D32190 | A-D32190 | JOHN DEERE | E51728 | A-E51728 |
| JOHN DEERE | D34099 | A-D34099 | JOHN DEERE | E52638 | A-E52638 |
| JOHN DEERE | D34405 | A-D34405 | JOHN DEERE | E52646 | A-E52646 |
| JOHN DEERE | D34828 | A-D34828 | JOHN DEERE | E53108 | A-E53108 |
| JOHN DEERE | D41981000 | A-D41981000 | JOHN DEERE | E53936 | A-E53936 |
| JOHN DEERE | DMU210306 | A-DMU210306 | JOHN DEERE | E54089 | A-E54089 |
| JOHN DEERE | DMU210479 | A-DMU210479 | JOHN DEERE | E55668 | A-E55668 |
| JOHN DEERE | DQ20810 | A-DQ20810 | JOHN DEERE | E56262 | A-E56262 |
| JOHN DEERE | DQ23754 | A-DQ23754 | JOHN DEERE | E57428 | A-E57428 |
| JOHN DEERE | DQ29594 | A-DQ29594 | JOHN DEERE | E58483 | A-E58483 |
| JOHN DEERE | E12574 | A-E12574 | JOHN DEERE | E58548 | A-E58548 |
| JOHN DEERE | E126459 | A-E126459 | JOHN DEERE | E58967 | A-E58967 |
| | | | JOHN DEERE | E61137 | A-E61137 |
| | | | JOHN DEERE | E62661 | A-E62661 |





JOHN DEERE

| OEM | OEM  Part No. | PIX  Part No. | OEM | OEM  Part No. | PIX  Part No. |
|------------|--|--|------------|--|--|
| JOHN DEERE | E63036 | A-E63036 | JOHN DEERE | H152146 | A-H 152146 |
| JOHN DEERE | E63457 | A-E63457 | JOHN DEERE | H154723 | A-H 154723 |
| JOHN DEERE | E63957 | A-E63957 | JOHN DEERE | H156541 | A-H 156541 |
| JOHN DEERE | E65863 | A-E65863 | JOHN DEERE | H160654 | A-H 160654 |
| JOHN DEERE | E69424 | A-E69424 | JOHN DEERE | H166077 | A-H 166077 |
| JOHN DEERE | E69465 | A-E69465 | JOHN DEERE | H171386 | A-H 171386 |
| JOHN DEERE | E69644 | A-E69644 | JOHN DEERE | H177178 | A-H 177178 |
| JOHN DEERE | E70357 | A-E70357 | JOHN DEERE | H202646 | A-H 202646 |
| JOHN DEERE | E70675 | A-E70675 | JOHN DEERE | H210476 | A-H 210476 |
| JOHN DEERE | E72331 | A-E72331 | JOHN DEERE | H211581 | A-H 211581 |
| JOHN DEERE | E72435 | A-E72435 | JOHN DEERE | H213353 | A-H 213353 |
| JOHN DEERE | E72830 | A-E72830 | JOHN DEERE | H218645 | A-H 218645 |
| JOHN DEERE | E75432 | A-E75432 | JOHN DEERE | H220911 | A-H 220911 |
| JOHN DEERE | E75596 | A-E75596 | JOHN DEERE | H221273 | A-H 221273 |
| JOHN DEERE | E76308 | A-E76308 | JOHN DEERE | H235564 | A-H 235564 |
| JOHN DEERE | E78277 | A-E78277 | JOHN DEERE | H238867 | A-H 238867 |
| JOHN DEERE | E79089 | A-E79089 | JOHN DEERE | HHH10556 | A-H Hh10556 |
| JOHN DEERE | E79907 | A-E79907 | JOHN DEERE | H105040 | A-H105040 |
| JOHN DEERE | E81146 | A-E81146 | JOHN DEERE | H113759 | A-H113759 |
| JOHN DEERE | E81147 | A-E81147 | JOHN DEERE | H132665 | A-H132665 |
| JOHN DEERE | E81892 | A-E81892 | JOHN DEERE | H135417 | A-H135417 |
| JOHN DEERE | E81907 | A-E81907 | JOHN DEERE | H136881 | A-H136881 |
| JOHN DEERE | E83737 | A-E83737 | JOHN DEERE | H136963 | A-H136963 |
| JOHN DEERE | E83777 | A-E83777 | JOHN DEERE | H137224 | A-H137224 |
| JOHN DEERE | E88931 | A-E88931 | JOHN DEERE | H138761 | A-H138761 |
| JOHN DEERE | E91269 | A-E91269 | JOHN DEERE | H139436 | A-H139436 |
| JOHN DEERE | E91575 | A-E91575 | JOHN DEERE | H140623 | A-H140623 |
| JOHN DEERE | EP0020 | A-EP0020 | JOHN DEERE | H145517 | A-H145517 |
| JOHN DEERE | FH10164 | A-FH10164 | JOHN DEERE | H145528 | A-H145528 |
| JOHN DEERE | FH10165 | A-FH10165 | JOHN DEERE | H155525 | A-H155525 |
| JOHN DEERE | FH305097 | A-FH305097 | JOHN DEERE | H156863 | A-H156863 |
| JOHN DEERE | FH318412 | A-FH318412 | JOHN DEERE | H157727 | A-H157727 |
| JOHN DEERE | G6876E | A-G6876E | JOHN DEERE | H158512 | A-H158512 |
| JOHN DEERE | GMJ1341 | A-GMJ1341 | JOHN DEERE | H160080 | A-H160080 |
| JOHN DEERE | GMJ1342 | A-GMJ1342 | JOHN DEERE | H160831 | A-H160831 |
| JOHN DEERE | GMJC19065 | A-GMJC19065 | JOHN DEERE | H161339 | A-H161339 |
| JOHN DEERE | GMJC21115 | A-GMJC21115 | JOHN DEERE | H161945 | A-H161945 |
| JOHN DEERE | GMJC26949 | A-GMJC26949 | JOHN DEERE | H162310 | A-H162310 |
| JOHN DEERE | GMJC26973 | A-GMJC26973 | JOHN DEERE | H162727 | A-H162727 |
| JOHN DEERE | GX10062 | A-GX10062 | JOHN DEERE | H163106 | A-H163106 |
| JOHN DEERE | GX10064 | A-GX10064 | JOHN DEERE | H163576 | A-H163576 |
| JOHN DEERE | GX20072 | A-GX20072 | JOHN DEERE | H164368 | A-H164368 |
| JOHN DEERE | GX21833 | A-GX21833 | JOHN DEERE | H164870 | A-H164870 |
| JOHN DEERE | H115881 | A-H 115881 | JOHN DEERE | H165015 | A-H165015 |
| JOHN DEERE | H131169 | A-H 131169 | JOHN DEERE | H165708 | A-H165708 |
| JOHN DEERE | H146636 | A-H 146636 | JOHN DEERE | H166077 | A-H166077 |
| | | | JOHN DEERE | H166457 | A-H166457 |





JOHN DEERE

| OEM | OEM  Part No. | PIX  Part No. | OEM | OEM  Part No. | PIX  Part No. |
|------------|--|--|------------|--|--|
| JOHN DEERE | H170047 | A-H170047 | JOHN DEERE | H227098 | A-H227098 |
| JOHN DEERE | H172610 | A-H172610 | JOHN DEERE | H228250 | A-H228250 |
| JOHN DEERE | H173832 | A-H173832 | JOHN DEERE | H228260 | A-H228260 |
| JOHN DEERE | H174367 | A-H174367 | JOHN DEERE | H228261 | A-H228261 |
| JOHN DEERE | H174456 | A-H174456 | JOHN DEERE | H228346 | A-H228346 |
| JOHN DEERE | H174457 | A-H174457 | JOHN DEERE | H228347 | A-H228347 |
| JOHN DEERE | H175631 | A-H175631 | JOHN DEERE | H228348 | A-H228348 |
| JOHN DEERE | H175742 | A-H175742 | JOHN DEERE | H228523 | A-H228523 |
| JOHN DEERE | H176536 | A-H176536 | JOHN DEERE | H229882 | A-H229882 |
| JOHN DEERE | H177186 | A-H177186 | JOHN DEERE | H23178 | A-H23178 |
| JOHN DEERE | H177263 | A-H177263 | JOHN DEERE | H232237 | A-H232237 |
| JOHN DEERE | H177887 | A-H177887 | JOHN DEERE | H232394 | A-H232394 |
| JOHN DEERE | H178037 | A-H178037 | JOHN DEERE | H23725 | A-H23725 |
| JOHN DEERE | H178757 | A-H178757 | JOHN DEERE | H23766 | A-H23766 |
| JOHN DEERE | H201794 | A-H201794 | JOHN DEERE | H23770 | A-H23770 |
| JOHN DEERE | H201851 | A-H201851 | JOHN DEERE | H23771 | A-H23771 |
| JOHN DEERE | H201916 | A-H201916 | JOHN DEERE | H238679 | A-H238679 |
| JOHN DEERE | H202646 | A-H202646 | JOHN DEERE | H238869 | A-H238869 |
| JOHN DEERE | H202647 | A-H202647 | JOHN DEERE | H238870 | A-H238870 |
| JOHN DEERE | H20406 | A-H20406 | JOHN DEERE | H238871 | A-H238871 |
| JOHN DEERE | H205240 | A-H205240 | JOHN DEERE | H240885 | A-H240885 |
| JOHN DEERE | H210001 | A-H210001 | JOHN DEERE | H24472 | A-H24472 |
| JOHN DEERE | H210003 | A-H210003 | JOHN DEERE | H24650 | A-H24650 |
| JOHN DEERE | H211763 | A-H211763 | JOHN DEERE | H24984 | A-H24984 |
| JOHN DEERE | H211764 | A-H211764 | JOHN DEERE | H25151 | A-H25151 |
| JOHN DEERE | H21233 | A-H21233 | JOHN DEERE | H25641 | A-H25641 |
| JOHN DEERE | H214375 | A-H214375 | JOHN DEERE | H25642H | A-H25642H |
| JOHN DEERE | H216026 | A-H216026 | JOHN DEERE | H25647 | A-H25647 |
| JOHN DEERE | H21666 | A-H21666 | JOHN DEERE | H26201H | A-H26201H |
| JOHN DEERE | H217141 | A-H217141 | JOHN DEERE | H27387 | A-H27387 |
| JOHN DEERE | H218197 | A-H218197 | JOHN DEERE | H27527 | A-H27527 |
| JOHN DEERE | H218198 | A-H218198 | JOHN DEERE | H27568 | A-H27568 |
| JOHN DEERE | H21882 | A-H21882 | JOHN DEERE | H27955 | A-H27955 |
| JOHN DEERE | H21925 | A-H21925 | JOHN DEERE | H28671 | A-H28671 |
| JOHN DEERE | H21929H | A-H21929H | JOHN DEERE | H28682 | A-H28682 |
| JOHN DEERE | H220051 | A-H220051 | JOHN DEERE | H28705 | A-H28705 |
| JOHN DEERE | H220052 | A-H220052 | JOHN DEERE | H28708 | A-H28708 |
| JOHN DEERE | H220053 | A-H220053 | JOHN DEERE | H28770 | A-H28770 |
| JOHN DEERE | H220884 | A-H220884 | JOHN DEERE | H29194 | A-H29194 |
| JOHN DEERE | H221324 | A-H221324 | JOHN DEERE | H31227 | A-H31227 |
| JOHN DEERE | H221327 | A-H221327 | JOHN DEERE | H31267 | A-H31267 |
| JOHN DEERE | H223384 | A-H223384 | JOHN DEERE | H31328 | A-H31328 |
| JOHN DEERE | H223916 | A-H223916 | JOHN DEERE | H31329 | A-H31329 |
| JOHN DEERE | H223917 | A-H223917 | JOHN DEERE | H31330 | A-H31330 |
| JOHN DEERE | H224184 | A-H224184 | JOHN DEERE | H31966 | A-H31966 |
| JOHN DEERE | H224185 | A-H224185 | JOHN DEERE | H32099 | A-H32099 |
| JOHN DEERE | H225035 | A-H225035 | JOHN DEERE | H32118 | A-H32118 |





JOHN DEERE

| OEM | OEM  Part No. | PIX  Part No. | OEM | OEM  Part No. | PIX  Part No. |
|------------|--|--|------------|--|--|
| JOHN DEERE | H32801 | A-H32801 | JOHN DEERE | H91814 | A-H91814 |
| JOHN DEERE | H32802 | A-H32802 | JOHN DEERE | H92080 | A-H92080 |
| JOHN DEERE | H33142 | A-H33142 | JOHN DEERE | H94254 | A-H94254 |
| JOHN DEERE | H33311 | A-H33311 | JOHN DEERE | H94508 | A-H94508 |
| JOHN DEERE | H33312 | A-H33312 | JOHN DEERE | H96248 | A-H96248 |
| JOHN DEERE | H33313 | A-H33313 | JOHN DEERE | H97652 | A-H97652 |
| JOHN DEERE | H33314 | A-H33314 | JOHN DEERE | H97692 | A-H97692 |
| JOHN DEERE | H33473 | A-H33473 | JOHN DEERE | H99515 | A-H99515 |
| JOHN DEERE | H33695 | A-H33695 | JOHN DEERE | HXE10785 | A-HXE10785 |
| JOHN DEERE | H34740 | A-H34740 | JOHN DEERE | HXE11255 | A-HXE11255 |
| JOHN DEERE | H34944 | A-H34944 | JOHN DEERE | HXE13951 | A-HXE13951 |
| JOHN DEERE | H35055 | A-H35055 | JOHN DEERE | HXE13957 | A-HXE13957 |
| JOHN DEERE | H35434 | A-H35434 | JOHN DEERE | HXE16940 | A-HXE16940 |
| JOHN DEERE | H35666 | A-H35666 | JOHN DEERE | HXE17071 | A-HXE17071 |
| JOHN DEERE | H35680 | A-H35680 | JOHN DEERE | HXE17164 | A-HXE17164 |
| JOHN DEERE | H35996 | A-H35996 | JOHN DEERE | HXE19401 | A-HXE19401 |
| JOHN DEERE | H35997 | A-H35997 | JOHN DEERE | HXE22087 | A-HXE22087 |
| JOHN DEERE | H35998 | A-H35998 | JOHN DEERE | HXE24210 | A-HXE24210 |
| JOHN DEERE | H62560 | A-H62560 | JOHN DEERE | HXE24687 | A-HXE24687 |
| JOHN DEERE | H62619 | A-H62619 | JOHN DEERE | HXE24688 | A-HXE24688 |
| JOHN DEERE | H62899 | A-H62899 | JOHN DEERE | HXE28843 | A-HXE28843 |
| JOHN DEERE | H63010 | A-H63010 | JOHN DEERE | HXE29021 | A-HXE29021 |
| JOHN DEERE | H63370 | A-H63370 | JOHN DEERE | HXE32806 | A-HXE32806 |
| JOHN DEERE | H63938 | A-H63938 | JOHN DEERE | HXE34473 | A-HXE34473 |
| JOHN DEERE | H63939 | A-H63939 | JOHN DEERE | HXE34567 | A-HXE34567 |
| JOHN DEERE | H64206 | A-H64206 | JOHN DEERE | HXE35822 | A-HXE35822 |
| JOHN DEERE | H64483 | A-H64483 | JOHN DEERE | HXE35957 | A-HXE35957 |
| JOHN DEERE | H64484 | A-H64484 | JOHN DEERE | HXE35958 | A-HXE35958 |
| JOHN DEERE | H64834 | A-H64834 | JOHN DEERE | HXE38000 | A-HXE38000 |
| JOHN DEERE | H64913 | A-H64913 | JOHN DEERE | HXE39119 | A-HXE39119 |
| JOHN DEERE | H75285 | A-H75285 | JOHN DEERE | HXE39397 | A-HXE39397 |
| JOHN DEERE | H75845 | A-H75845 | JOHN DEERE | HXE41402 | A-HXE41402 |
| JOHN DEERE | H76378 | A-H76378 | JOHN DEERE | HXE43428 | A-HXE43428 |
| JOHN DEERE | H77021 | A-H77021 | JOHN DEERE | HXE44273 | A-HXE44273 |
| JOHN DEERE | H77291 | A-H77291 | JOHN DEERE | HXE45928 | A-HXE45928 |
| JOHN DEERE | H79073 | A-H79073 | JOHN DEERE | HXE46515 | A-HXE46515 |
| JOHN DEERE | H79795 | A-H79795 | JOHN DEERE | HXE95935 | A-HXE95935 |
| JOHN DEERE | H81171 | A-H81171 | JOHN DEERE | J0019028 | A-J0019028 |
| JOHN DEERE | H81975 | A-H81975 | JOHN DEERE | J17878 | A-J17878 |
| JOHN DEERE | H81976 | A-H81976 | JOHN DEERE | J18038 | A-J18038 |
| JOHN DEERE | H81977 | A-H81977 | JOHN DEERE | J18470 | A-J18470 |
| JOHN DEERE | H84236 | A-H84236 | JOHN DEERE | J18477 | A-J18477 |
| JOHN DEERE | H84422 | A-H84422 | JOHN DEERE | J18796 | A-J18796 |
| JOHN DEERE | H86017 | A-H86017 | JOHN DEERE | J19214 | A-J19214 |
| JOHN DEERE | H86059 | A-H86059 | JOHN DEERE | J20475 | A-J20475 |
| JOHN DEERE | H87256 | A-H87256 | JOHN DEERE | J57007 | A-J57007 |
| JOHN DEERE | H88455 | A-H88455 | JOHN DEERE | J57065 | A-J57065 |





JOHN DEERE

| OEM | OEM  Part No. | PIX  Part No. | OEM | OEM  Part No. | PIX  Part No. |
|------------|--|--|------------|--|--|
| JOHN DEERE | J57234 | A-J57234 | JOHN DEERE | L155538 | A-L155538 |
| JOHN DEERE | JDE61326 | A-JDE61326 | JOHN DEERE | L155538V | A-L155538V |
| JOHN DEERE | L101166 | A-L101166 | JOHN DEERE | L166309 | A-L166309 |
| JOHN DEERE | L101411 | A-L101411 | JOHN DEERE | L169272 | A-L169272 |
| JOHN DEERE | L110391 | A-L110391 | JOHN DEERE | L169273 | A-L169273 |
| JOHN DEERE | L110599 | A-L110599 | JOHN DEERE | L169990 | A-L169990 |
| JOHN DEERE | L11060 | A-L11060 | JOHN DEERE | L1711 | A-L1711 |
| JOHN DEERE | L110600 | A-L110600 | JOHN DEERE | L172523 | A-L172523 |
| JOHN DEERE | L110602 | A-L110602 | JOHN DEERE | L1887 | A-L1887 |
| JOHN DEERE | L110603 | A-L110603 | JOHN DEERE | L1888 | A-L1888 |
| JOHN DEERE | L110605 | A-L110605 | JOHN DEERE | L1890C | A-L1890C |
| JOHN DEERE | L110606 | A-L110606 | JOHN DEERE | L1894 | A-L1894 |
| JOHN DEERE | L110607 | A-L110607 | JOHN DEERE | L1899 | A-L1899 |
| JOHN DEERE | L110608 | A-L110608 | JOHN DEERE | L200916 | A-L200916 |
| JOHN DEERE | L110609 | A-L110609 | JOHN DEERE | L201806 | A-L201806 |
| JOHN DEERE | L111087 | A-L111087 | JOHN DEERE | L202229 | A-L202229 |
| JOHN DEERE | L1111 | A-L1111 | JOHN DEERE | L202230 | A-L202230 |
| JOHN DEERE | L111148 | A-L111148 | JOHN DEERE | L203293 | A-L203293 |
| JOHN DEERE | L111169 | A-L111169 | JOHN DEERE | L203294 | A-L203294 |
| JOHN DEERE | L111170 | A-L111170 | JOHN DEERE | L203295 | A-L203295 |
| JOHN DEERE | L111600 | A-L111600 | JOHN DEERE | L203299 | A-L203299 |
| JOHN DEERE | L111601 | A-L111601 | JOHN DEERE | L203300 | A-L203300 |
| JOHN DEERE | L111602 | A-L111602 | JOHN DEERE | L203302 | A-L203302 |
| JOHN DEERE | L111685 | A-L111685 | JOHN DEERE | L203305 | A-L203305 |
| JOHN DEERE | L111801 | A-L111801 | JOHN DEERE | L203306 | A-L203306 |
| JOHN DEERE | L111804 | A-L111804 | JOHN DEERE | L203307 | A-L203307 |
| JOHN DEERE | L111933 | A-L111933 | JOHN DEERE | L213022 | A-L213022 |
| JOHN DEERE | L114286 | A-L114286 | JOHN DEERE | L213023 | A-L213023 |
| JOHN DEERE | L114290 | A-L114290 | JOHN DEERE | L2217 | A-L2217 |
| JOHN DEERE | L114292 | A-L114292 | JOHN DEERE | L3700 | A-L3700 |
| JOHN DEERE | L114293 | A-L114293 | JOHN DEERE | L41330 | A-L41330 |
| JOHN DEERE | L114468 | A-L114468 | JOHN DEERE | L41331 | A-L41331 |
| JOHN DEERE | L114487 | A-L114487 | JOHN DEERE | L4319N | A-L4319N |
| JOHN DEERE | L114488 | A-L114488 | JOHN DEERE | L4339 | A-L4339 |
| JOHN DEERE | L114489 | A-L114489 | JOHN DEERE | L4339N | A-L4339N |
| JOHN DEERE | L115657 | A-L115657 | JOHN DEERE | L4490N | A-L4490N |
| JOHN DEERE | L115658 | A-L115658 | JOHN DEERE | L59206 | A-L59206 |
| JOHN DEERE | L115659 | A-L115659 | JOHN DEERE | L64175 | A-L64175 |
| JOHN DEERE | L115660 | A-L115660 | JOHN DEERE | L64406 | A-L64406 |
| JOHN DEERE | L115661 | A-L115661 | JOHN DEERE | L79344 | A-L79344 |
| JOHN DEERE | L1293 | A-L1293 | JOHN DEERE | L79943 | A-L79943 |
| JOHN DEERE | L1305 | A-L1305 | JOHN DEERE | L79945 | A-L79945 |
| JOHN DEERE | L1323 | A-L1323 | JOHN DEERE | LVU11659 | A-LVU11659 |
| JOHN DEERE | L1328 | A-L1328 | JOHN DEERE | M118756 | A-M118756 |
| JOHN DEERE | L153280 | A-L153280 | | | |
| JOHN DEERE | L153281 | A-L153281 | | | |
| JOHN DEERE | L153282 | A-L153282 | | | |





JOHN DEERE

| OEM | OEM  Part No. | PIX  Part No. | OEM | OEM  Part No. | PIX  Part No. |
|------------|--|--|------------|--|--|
| JOHN DEERE | M122075 | A-M122075 | JOHN DEERE | N121116 | A-N121116 |
| JOHN DEERE | M125383 | A-M125383 | JOHN DEERE | N121235 | A-N121235 |
| JOHN DEERE | M140502 | A-M140502 | JOHN DEERE | N121448 | A-N121448 |
| JOHN DEERE | M141627 | A-M141627 | JOHN DEERE | N121874 | A-N121874 |
| JOHN DEERE | M143888 | A-M143888 | JOHN DEERE | N123657 | A-N123657 |
| JOHN DEERE | M154295 | A-M154295 | JOHN DEERE | N124017 | A-N124017 |
| JOHN DEERE | M1900T | A-M1900T | JOHN DEERE | N124460 | A-N124460 |
| JOHN DEERE | M41592 | A-M41592 | JOHN DEERE | N125041 | A-N125041 |
| JOHN DEERE | M41642 | A-M41642 | JOHN DEERE | N12551 | A-N12551 |
| JOHN DEERE | M42485 | A-M42485 | JOHN DEERE | N128466 | A-N128466 |
| JOHN DEERE | M43569 | A-M43569 | JOHN DEERE | N128930 | A-N128930 |
| JOHN DEERE | M44272 | A-M44272 | JOHN DEERE | N129508 | A-N129508 |
| JOHN DEERE | M72031 | A-M72031 | JOHN DEERE | N129916 | A-N129916 |
| JOHN DEERE | M82538 | A-M82538 | JOHN DEERE | N129955 | A-N129955 |
| JOHN DEERE | M82720 | A-M82720 | JOHN DEERE | N150166 | A-N150166 |
| JOHN DEERE | N10068 | A-N10068 | JOHN DEERE | N150864 | A-N150864 |
| JOHN DEERE | N101027 | A-N101027 | JOHN DEERE | N15200 | A-N15200 |
| JOHN DEERE | N10192 | A-N10192 | JOHN DEERE | N15201 | A-N15201 |
| JOHN DEERE | N105015 | A-N105015 | JOHN DEERE | N15202 | A-N15202 |
| JOHN DEERE | N105016 | A-N105016 | JOHN DEERE | N153524 | A-N153524 |
| JOHN DEERE | N107439 | A-N107439 | JOHN DEERE | N154241 | A-N154241 |
| JOHN DEERE | N110051 | A-N110051 | JOHN DEERE | N15527 | A-N15527 |
| JOHN DEERE | N11057 | A-N11057 | JOHN DEERE | N15528 | A-N15528 |
| JOHN DEERE | N11117 | A-N11117 | JOHN DEERE | N15697 | A-N15697 |
| JOHN DEERE | N111527 | A-N111527 | JOHN DEERE | N157368 | A-N157368 |
| JOHN DEERE | N113642 | A-N113642 | JOHN DEERE | N157369 | A-N157369 |
| JOHN DEERE | N115368 | A-N115368 | JOHN DEERE | N15898 | A-N15898 |
| JOHN DEERE | N117398 | A-N117398 | JOHN DEERE | N170856 | A-N170856 |
| JOHN DEERE | N117674 | A-N117674 | JOHN DEERE | N174442 | A-N174442 |
| JOHN DEERE | N119624 | A-N119624 | JOHN DEERE | N190043 | A-N190043 |
| JOHN DEERE | N120086 | A-N120086 | JOHN DEERE | N193822 | A-N193822 |
| JOHN DEERE | N120289 | A-N120289 | JOHN DEERE | N202856 | A-N202856 |
| JOHN DEERE | N120715 | A-N120715 | JOHN DEERE | N210577 | A-N210577 |
| JOHN DEERE | N120717 | A-N120717 | JOHN DEERE | N220907 | A-N220907 |
| JOHN DEERE | N121113 | A-N121113 | JOHN DEERE | N221266 | A-N221266 |
| JOHN DEERE | N121114 | A-N121114 | JOHN DEERE | N221269 | A-N221269 |
| JOHN DEERE | HXE36535 | A-HXE36535 | JOHN DEERE | N222344 | A-N222344 |
| JOHN DEERE | HXE38073 | A-HXE38073 | JOHN DEERE | N223125 | A-N223125 |
| JOHN DEERE | HXE50398 | A-HXE50398 | JOHN DEERE | N274995 | A-N274995 |
| JOHN DEERE | HXE68015 | A-HXE68015 | JOHN DEERE | N30716 | A-N30716 |
| JOHN DEERE | HXE68016 | A-HXE68016 | JOHN DEERE | N310738 | A-N310738 |
| JOHN DEERE | HXE69281 | A-HXE69281 | JOHN DEERE | N31193 | A-N31193 |
| JOHN DEERE | HXE71061 | A-HXE71061 | JOHN DEERE | N31233 | A-N31233 |
| JOHN DEERE | HXE102288 | A-HXE102288 | JOHN DEERE | N31437 | A-N31437 |
| JOHN DEERE | HXE124869 | A-HXE124869 | JOHN DEERE | N31649 | A-N31649 |
| JOHN DEERE | P59855 | A-P59855 | JOHN DEERE | N32249 | A-N32249 |
| JOHN DEERE | R300399 | A-R300399 | JOHN DEERE | N33746 | A-N33746 |





JOHN DEERE

| OEM | OEM  Part No. | PIX  Part No. | OEM | OEM  Part No. | PIX  Part No. |
|------------|--|--|------------|--|--|
| JOHN DEERE | N34820 | A-N34820 | JOHN DEERE | R116492 | A-R116492 |
| JOHN DEERE | N34821 | A-N34821 | JOHN DEERE | R118317 | A-R118317 |
| JOHN DEERE | N34881 | A-N34881 | JOHN DEERE | R118318 | A-R118318 |
| JOHN DEERE | N35158 | A-N35158 | JOHN DEERE | R120524 | A-R120524 |
| JOHN DEERE | N371322 | A-N371322 | JOHN DEERE | R120852 | A-R120852 |
| JOHN DEERE | N372967 | A-N372967 | JOHN DEERE | R122126 | A-R122126 |
| JOHN DEERE | N374493 | A-N374493 | JOHN DEERE | R123292 | A-R123292 |
| JOHN DEERE | N376377 | A-N376377 | JOHN DEERE | R123293 | A-R123293 |
| JOHN DEERE | N377281 | A-N377281 | JOHN DEERE | R123294 | A-R123294 |
| JOHN DEERE | N378575 | A-N378575 | JOHN DEERE | R123296 | A-R123296 |
| JOHN DEERE | N51225 | A-N51225 | JOHN DEERE | R123306 | A-R123306 |
| JOHN DEERE | N51288 | A-N51288 | JOHN DEERE | R123307 | A-R123307 |
| JOHN DEERE | P25217 | A-P25217 | JOHN DEERE | R123308 | A-R123308 |
| JOHN DEERE | P35760 | A-P35760 | JOHN DEERE | R123432 | A-R123432 |
| JOHN DEERE | P40017 | A-P40017 | JOHN DEERE | R123436 | A-R123436 |
| JOHN DEERE | P40023 | A-P40023 | JOHN DEERE | R123437 | A-R123437 |
| JOHN DEERE | P40058H | A-P40058H | JOHN DEERE | R123438 | A-R123438 |
| JOHN DEERE | P40278 | A-P40278 | JOHN DEERE | R123441 | A-R123441 |
| JOHN DEERE | P40281 | A-P40281 | JOHN DEERE | R123442 | A-R123442 |
| JOHN DEERE | P41561 | A-P41561 | JOHN DEERE | R123445 | A-R123445 |
| JOHN DEERE | P43323 | A-P43323 | JOHN DEERE | R123449 | A-R123449 |
| JOHN DEERE | P47192 | A-P47192 | JOHN DEERE | R123450 | A-R123450 |
| JOHN DEERE | P47397 | A-P47397 | JOHN DEERE | R123453 | A-R123453 |
| JOHN DEERE | P48084 | A-P48084 | JOHN DEERE | R123456 | A-R123456 |
| JOHN DEERE | P49414 | A-P49414 | JOHN DEERE | R123457 | A-R123457 |
| JOHN DEERE | P49603 | A-P49603 | JOHN DEERE | R123458 | A-R123458 |
| JOHN DEERE | P49938 | A-P49938 | JOHN DEERE | R123459 | A-R123459 |
| JOHN DEERE | P50749 | A-P50749 | JOHN DEERE | R123460 | A-R123460 |
| JOHN DEERE | P51165 | A-P51165 | JOHN DEERE | R123462 | A-R123462 |
| JOHN DEERE | P55377 | A-P55377 | JOHN DEERE | R123463 | A-R123463 |
| JOHN DEERE | PT9483 | A-PT9483 | JOHN DEERE | R123464 | A-R123464 |
| JOHN DEERE | R101069 | A-R101069 | JOHN DEERE | R123465 | A-R123465 |
| JOHN DEERE | R106120 | A-R106120 | JOHN DEERE | R123466 | A-R123466 |
| JOHN DEERE | R106120V | A-R106120V | JOHN DEERE | R123468 | A-R123468 |
| JOHN DEERE | R106120V | A-R106120V | JOHN DEERE | R123469 | A-R123469 |
| JOHN DEERE | R106122 | A-R106122 | JOHN DEERE | R123470 | A-R123470 |
| JOHN DEERE | R106123 | A-R106123 | JOHN DEERE | R123522 | A-R123522 |
| JOHN DEERE | R107324 | A-R107324 | JOHN DEERE | R124785 | A-R124785 |
| JOHN DEERE | R108842 | A-R108842 | JOHN DEERE | R124786 | A-R124786 |
| JOHN DEERE | R111090 | A-R111090 | JOHN DEERE | R125361 | A-R125361 |
| JOHN DEERE | R115257 | A-R115257 | JOHN DEERE | R125752 | A-R125752 |
| JOHN DEERE | R115614 | A-R115614 | JOHN DEERE | R128196 | A-R128196 |
| JOHN DEERE | R115614V | A-R115614V | JOHN DEERE | R128197 | A-R128197 |
| JOHN DEERE | R115614V | A-R115614V | JOHN DEERE | R128198 | A-R128198 |
| JOHN DEERE | R115935 | A-R115935 | JOHN DEERE | R128199 | A-R128199 |
| JOHN DEERE | R115936 | A-R115936 | JOHN DEERE | R128200 | A-R128200 |
| JOHN DEERE | R116307 | A-R116307 | JOHN DEERE | R128201 | A-R128201 |





JOHN DEERE

| OEM | OEM  Part No. | PIX  Part No. | OEM | OEM  Part No. | PIX  Part No. |
|------------|--|--|------------|--|--|
| JOHN DEERE | R128202 | A-R128202 | JOHN DEERE | R134631 | A-R134631 |
| JOHN DEERE | R128203 | A-R128203 | JOHN DEERE | R134632 | A-R134632 |
| JOHN DEERE | R128204 | A-R128204 | JOHN DEERE | R134634 | A-R134634 |
| JOHN DEERE | R128205 | A-R128205 | JOHN DEERE | R134635 | A-R134635 |
| JOHN DEERE | R128206 | A-R128206 | JOHN DEERE | R134636 | A-R134636 |
| JOHN DEERE | R128208 | A-R128208 | JOHN DEERE | R134637 | A-R134637 |
| JOHN DEERE | R128209 | A-R128209 | JOHN DEERE | R134638 | A-R134638 |
| JOHN DEERE | R128210 | A-R128210 | JOHN DEERE | R135169 | A-R135169 |
| JOHN DEERE | R128502 | A-R128502 | JOHN DEERE | R135188 | A-R135188 |
| JOHN DEERE | R128806 | A-R128806 | JOHN DEERE | R135189 | A-R135189 |
| JOHN DEERE | R129083 | A-R129083 | JOHN DEERE | R135192 | A-R135192 |
| JOHN DEERE | R129738 | A-R129738 | JOHN DEERE | R135193 | A-R135193 |
| JOHN DEERE | R130478 | A-R130478 | JOHN DEERE | R135194 | A-R135194 |
| JOHN DEERE | R130852 | A-R130852 | JOHN DEERE | R135195 | A-R135195 |
| JOHN DEERE | R130889 | A-R130889 | JOHN DEERE | R135198 | A-R135198 |
| JOHN DEERE | R130899 | A-R130899 | JOHN DEERE | R135199 | A-R135199 |
| JOHN DEERE | R131083 | A-R131083 | JOHN DEERE | R135200 | A-R135200 |
| JOHN DEERE | R131213 | A-R131213 | JOHN DEERE | R135438 | A-R135438 |
| JOHN DEERE | R131213 | A-R131213 | JOHN DEERE | R135568 | A-R135568 |
| JOHN DEERE | R131433 | A-R131433 | JOHN DEERE | R135589 | A-R135589 |
| JOHN DEERE | R131434 | A-R131434 | JOHN DEERE | R135590 | A-R135590 |
| JOHN DEERE | R131436 | A-R131436 | JOHN DEERE | R135591 | A-R135591 |
| JOHN DEERE | R132159 | A-R132159 | JOHN DEERE | R135592 | A-R135592 |
| JOHN DEERE | R132925 | A-R132925 | JOHN DEERE | R135593 | A-R135593 |
| JOHN DEERE | R133402 | A-R133402 | JOHN DEERE | R135594 | A-R135594 |
| JOHN DEERE | R133518 | A-R133518 | JOHN DEERE | R135595 | A-R135595 |
| JOHN DEERE | R133693 | A-R133693 | JOHN DEERE | R135596 | A-R135596 |
| JOHN DEERE | R133694 | A-R133694 | JOHN DEERE | R135597 | A-R135597 |
| JOHN DEERE | R133695 | A-R133695 | JOHN DEERE | R135598 | A-R135598 |
| JOHN DEERE | R133696 | A-R133696 | JOHN DEERE | R135599 | A-R135599 |
| JOHN DEERE | R133697 | A-R133697 | JOHN DEERE | R135600 | A-R135600 |
| JOHN DEERE | R133699 | A-R133699 | JOHN DEERE | R135601 | A-R135601 |
| JOHN DEERE | R133700 | A-R133700 | JOHN DEERE | R135602 | A-R135602 |
| JOHN DEERE | R133701 | A-R133701 | JOHN DEERE | R135603 | A-R135603 |
| JOHN DEERE | R133702 | A-R133702 | JOHN DEERE | R135604 | A-R135604 |
| JOHN DEERE | R133703 | A-R133703 | JOHN DEERE | R135605 | A-R135605 |
| JOHN DEERE | R133704 | A-R133704 | JOHN DEERE | R135607 | A-R135607 |
| JOHN DEERE | R133705 | A-R133705 | JOHN DEERE | R135608 | A-R135608 |
| JOHN DEERE | R133706 | A-R133706 | JOHN DEERE | R135611 | A-R135611 |
| JOHN DEERE | R133707 | A-R133707 | JOHN DEERE | R135612 | A-R135612 |
| JOHN DEERE | R133852 | A-R133852 | JOHN DEERE | R135613 | A-R135613 |
| JOHN DEERE | R133853 | A-R133853 | JOHN DEERE | R135614 | A-R135614 |
| JOHN DEERE | R134299 | A-R134299 | JOHN DEERE | R135615 | A-R135615 |
| JOHN DEERE | R134594 | A-R134594 | JOHN DEERE | R135663 | A-R135663 |
| JOHN DEERE | R134599 | A-R134599 | JOHN DEERE | R135664 | A-R135664 |
| JOHN DEERE | R134625 | A-R134625 | JOHN DEERE | R135665 | A-R135665 |
| JOHN DEERE | R134630 | A-R134630 | JOHN DEERE | R135680 | A-R135680 |





JOHN DEERE

| OEM | OEM  Part No. | PIX  Part No. | OEM | OEM  Part No. | PIX  Part No. |
|------------|--|--|------------|--|--|
| JOHN DEERE | R135681 | A-R135681 | JOHN DEERE | R500379 | A-R500379 |
| JOHN DEERE | R135822 | A-R135822 | JOHN DEERE | R500380 | A-R500380 |
| JOHN DEERE | R135823 | A-R135823 | JOHN DEERE | R500381 | A-R500381 |
| JOHN DEERE | R135824 | A-R135824 | JOHN DEERE | R500382 | A-R500382 |
| JOHN DEERE | R135826 | A-R135826 | JOHN DEERE | R500383 | A-R500383 |
| JOHN DEERE | R135977 | A-R135977 | JOHN DEERE | R500384 | A-R500384 |
| JOHN DEERE | R136235 | A-R136235 | JOHN DEERE | R500385 | A-R500385 |
| JOHN DEERE | R136284 | A-R136284 | JOHN DEERE | R500616 | A-R500616 |
| JOHN DEERE | R136384 | A-R136384 | JOHN DEERE | R501007 | A-R501007 |
| JOHN DEERE | R136535 | A-R136535 | JOHN DEERE | R501017 | A-R501017 |
| JOHN DEERE | R156049 | A-R156049 | JOHN DEERE | R501053 | A-R501053 |
| JOHN DEERE | R156050 | A-R156050 | JOHN DEERE | R501191 | A-R501191 |
| JOHN DEERE | R157686 | A-R157686 | JOHN DEERE | R501266 | A-R501266 |
| JOHN DEERE | R157687 | A-R157687 | JOHN DEERE | R501308 | A-R501308 |
| JOHN DEERE | R157688 | A-R157688 | JOHN DEERE | R501526 | A-R501526 |
| JOHN DEERE | R157688 | A-R157688 | JOHN DEERE | R502016 | A-R502016 |
| JOHN DEERE | R174754 | A-R174754 | JOHN DEERE | R502078 | A-R502078 |
| JOHN DEERE | R175712 | A-R175712 | JOHN DEERE | R502086 | A-R502086 |
| JOHN DEERE | R175825 | A-R175825 | JOHN DEERE | R502089 | A-R502089 |
| JOHN DEERE | R175826 | A-R175826 | JOHN DEERE | R502186 | A-R502186 |
| JOHN DEERE | R181917 | A-R181917 | JOHN DEERE | R502306 | A-R502306 |
| JOHN DEERE | R181918 | A-R181918 | JOHN DEERE | R502416 | A-R502416 |
| JOHN DEERE | R190199 | A-R190199 | JOHN DEERE | R502417 | A-R502417 |
| JOHN DEERE | R199163 | A-R199163 | JOHN DEERE | R502418 | A-R502418 |
| JOHN DEERE | R200920 | A-R200920 | JOHN DEERE | R502461 | A-R502461 |
| JOHN DEERE | R202628 | A-R202628 | JOHN DEERE | R502476 | A-R502476 |
| JOHN DEERE | R205438 | A-R205438 | JOHN DEERE | R502599 | A-R502599 |
| JOHN DEERE | R206983 | A-R206983 | JOHN DEERE | R503311 | A-R503311 |
| JOHN DEERE | R208755 | A-R208755 | JOHN DEERE | R503323 | A-R503323 |
| JOHN DEERE | R210808 | A-R210808 | JOHN DEERE | R503324 | A-R503324 |
| JOHN DEERE | R211183 | A-R211183 | JOHN DEERE | R503571 | A-R503571 |
| JOHN DEERE | R216071 | A-R216071 | JOHN DEERE | R503726 | A-R503726 |
| JOHN DEERE | R222393 | A-R222393 | JOHN DEERE | R503932 | A-R503932 |
| JOHN DEERE | R228118 | A-R228118 | JOHN DEERE | R504022 | A-R504022 |
| JOHN DEERE | R228566 | A-R228566 | JOHN DEERE | R504023 | A-R504023 |
| JOHN DEERE | R239551 | A-R239551 | JOHN DEERE | R504963 | A-R504963 |
| JOHN DEERE | R241746 | A-R241746 | JOHN DEERE | R505186 | A-R505186 |
| JOHN DEERE | R267275 | A-R267275 | JOHN DEERE | R505810 | A-R505810 |
| JOHN DEERE | R269530 | A-R269530 | JOHN DEERE | R505812 | A-R505812 |
| JOHN DEERE | R269531 | A-R269531 | JOHN DEERE | R515127 | A-R515127 |
| JOHN DEERE | R288922 | A-R288922 | JOHN DEERE | R515209 | A-R515209 |
| JOHN DEERE | R500089 | A-R500089 | JOHN DEERE | R515217 | A-R515217 |
| JOHN DEERE | R500090 | A-R500090 | JOHN DEERE | R515219 | A-R515219 |
| JOHN DEERE | R500173 | A-R500173 | JOHN DEERE | R515220 | A-R515220 |
| JOHN DEERE | R500244 | A-R500244 | JOHN DEERE | R515222 | A-R515222 |
| JOHN DEERE | R500377 | A-R500377 | JOHN DEERE | R517012 | A-R517012 |
| JOHN DEERE | R500378 | A-R500378 | JOHN DEERE | R517039 | A-R517039 |





JOHN DEERE

| OEM | OEM  Part No. | PIX  Part No. | OEM | OEM  Part No. | PIX  Part No. |
|------------|--|--|------------|--|--|
| JOHN DEERE | R517041 | A-R517041 | JOHN DEERE | SA00901 | A-SA00901 |
| JOHN DEERE | R518368 | A-R518368 | JOHN DEERE | SA01001 | A-SA01001 |
| JOHN DEERE | R71602 | A-R71602 | JOHN DEERE | SA01201 | A-SA01201 |
| JOHN DEERE | R94373 | A-R94373 | JOHN DEERE | SA01401 | A-SA01401 |
| JOHN DEERE | R95917 | A-R95917 | JOHN DEERE | SA01601 | A-SA01601 |
| JOHN DEERE | R95924 | A-R95924 | JOHN DEERE | SA01701 | A-SA01701 |
| JOHN DEERE | R96255 | A-R96255 | JOHN DEERE | SA02001 | A-SA02001 |
| JOHN DEERE | R97758 | A-R97758 | JOHN DEERE | SA35274 | A-SA35274 |
| JOHN DEERE | R98510 | A-R98510 | JOHN DEERE | SA35425 | A-SA35425 |
| JOHN DEERE | RE28721 | A-RE28721 | JOHN DEERE | SA36024 | A-SA36024 |
| JOHN DEERE | RE29018 | A-RE29018 | JOHN DEERE | SA36101 | A-SA36101 |
| JOHN DEERE | S07074 | A-S07074 | JOHN DEERE | SA36130 | A-SA36130 |
| JOHN DEERE | S07075 | A-S07075 | JOHN DEERE | SA36192 | A-SA36192 |
| JOHN DEERE | S08035 | A-S08035 | JOHN DEERE | SA36523 | A-SA36523 |
| JOHN DEERE | S13042 | A-S13042 | JOHN DEERE | SA36536 | A-SA36536 |
| JOHN DEERE | S17045 | A-S17045 | JOHN DEERE | SA36701 | A-SA36701 |
| JOHN DEERE | S20718 | A-S20718 | JOHN DEERE | SA36717 | A-SA36717 |
| JOHN DEERE | S33368 | A-S33368 | JOHN DEERE | SAU10552 | A-SAU10552 |
| JOHN DEERE | S33510 | A-S33510 | JOHN DEERE | SAU10691 | A-SAU10691 |
| JOHN DEERE | S33512 | A-S33512 | JOHN DEERE | SAU11073 | A-SAU11073 |
| JOHN DEERE | S33602 | A-S33602 | JOHN DEERE | SAU11158 | A-SAU11158 |
| JOHN DEERE | S33605 | A-S33605 | JOHN DEERE | SAU11284 | A-SAU11284 |
| JOHN DEERE | S33607 | A-S33607 | JOHN DEERE | SAU11321 | A-SAU11321 |
| JOHN DEERE | S33721 | A-S33721 | JOHN DEERE | SAU11644 | A-SAU11644 |
| JOHN DEERE | S37599 | A-S37599 | JOHN DEERE | SAU11645 | A-SAU11645 |
| JOHN DEERE | S37687 | A-S37687 | JOHN DEERE | SAU12081 | A-SAU12081 |
| JOHN DEERE | S38916 | A-S38916 | JOHN DEERE | T10552 | A-T10552 |
| JOHN DEERE | S41607 | A-S41607 | JOHN DEERE | T111546 | A-T111546 |
| JOHN DEERE | S41608 | A-S41608 | JOHN DEERE | T148208 | A-T148208 |
| JOHN DEERE | S41884 | A-S41884 | JOHN DEERE | T155457 | A-T155457 |
| JOHN DEERE | S42174 | A-S42174 | JOHN DEERE | T160034 | A-T160034 |
| JOHN DEERE | S43359 | A-S43359 | JOHN DEERE | T160036 | A-T160036 |
| JOHN DEERE | S43537 | A-S43537 | JOHN DEERE | T164949 | A-T164949 |
| JOHN DEERE | S60001 | A-S60001 | JOHN DEERE | T166823 | A-T166823 |
| JOHN DEERE | S60004 | A-S60004 | JOHN DEERE | T178409 | A-T178409 |
| JOHN DEERE | S60011 | A-S60011 | JOHN DEERE | T178410 | A-T178410 |
| JOHN DEERE | S60012 | A-S60012 | JOHN DEERE | T178411 | A-T178411 |
| JOHN DEERE | S60016 | A-S60016 | JOHN DEERE | T178412 | A-T178412 |
| JOHN DEERE | S60018 | A-S60018 | JOHN DEERE | T178413 | A-T178413 |
| JOHN DEERE | S60021 | A-S60021 | JOHN DEERE | T178414 | A-T178414 |
| JOHN DEERE | S60022 | A-S60022 | JOHN DEERE | T178415 | A-T178415 |
| JOHN DEERE | SA00101 | A-SA00101 | JOHN DEERE | T178416 | A-T178416 |
| JOHN DEERE | SA00201 | A-SA00201 | JOHN DEERE | T178417 | A-T178417 |
| JOHN DEERE | SA00301 | A-SA00301 | JOHN DEERE | T178418 | A-T178418 |
| JOHN DEERE | SA00401 | A-SA00401 | JOHN DEERE | T178419 | A-T178419 |
| JOHN DEERE | SA00501 | A-SA00501 | JOHN DEERE | T178420 | A-T178420 |
| | | | JOHN DEERE | T178421 | A-T178421 |





JOHN DEERE

| OEM | OEM  Part No. | PIX  Part No. | OEM | OEM  Part No. | PIX  Part No. |
|------------|--|--|------------|--|--|
| JOHN DEERE | T178422 | A-T178422 | JOHN DEERE | YC10136 | A-YC10136 |
| JOHN DEERE | T178423 | A-T178423 | JOHN DEERE | YC10139 | A-YC10139 |
| JOHN DEERE | T178465 | A-T178465 | JOHN DEERE | YC10140 | A-YC10140 |
| JOHN DEERE | T178536 | A-T178536 | JOHN DEERE | YC10142 | A-YC10142 |
| JOHN DEERE | T178537 | A-T178537 | JOHN DEERE | YC10144 | A-YC10144 |
| JOHN DEERE | T178538 | A-T178538 | JOHN DEERE | YC10145 | A-YC10145 |
| JOHN DEERE | T178539 | A-T178539 | JOHN DEERE | YC10148 | A-YC10148 |
| JOHN DEERE | T178548 | A-T178548 | JOHN DEERE | YC17499 | A-YC17499 |
| JOHN DEERE | T180368 | A-T180368 | JOHN DEERE | YC19018 | A-YC19018 |
| JOHN DEERE | T182169 | A-T182169 | JOHN DEERE | YC19023 | A-YC19023 |
| JOHN DEERE | T184590 | A-T184590 | JOHN DEERE | YC19024 | A-YC19024 |
| JOHN DEERE | T184592 | A-T184592 | JOHN DEERE | YC19027 | A-YC19027 |
| JOHN DEERE | T184594 | A-T184594 | JOHN DEERE | YC25169 | A-YC25169 |
| JOHN DEERE | T184595 | A-T184595 | JOHN DEERE | YC25170 | A-YC25170 |
| JOHN DEERE | T185061 | A-T185061 | JOHN DEERE | Z101214 | A-Z101214 |
| JOHN DEERE | T185081 | A-T185081 | JOHN DEERE | Z103479 | A-Z103479 |
| JOHN DEERE | T186776 | A-T186776 | JOHN DEERE | Z103583 | A-Z103583 |
| JOHN DEERE | T187391 | A-T187391 | JOHN DEERE | Z103861 | A-Z103861 |
| JOHN DEERE | T187704 | A-T187704 | JOHN DEERE | Z103867 | A-Z103867 |
| JOHN DEERE | T189016 | A-T189016 | JOHN DEERE | Z104104 | A-Z104104 |
| JOHN DEERE | T190384 | A-T190384 | JOHN DEERE | Z104978 | A-Z104978 |
| JOHN DEERE | T190809 | A-T190809 | JOHN DEERE | Z105041 | A-Z105041 |
| JOHN DEERE | T190810 | A-T190810 | JOHN DEERE | Z105506 | A-Z105506 |
| JOHN DEERE | T190817 | A-T190817 | JOHN DEERE | Z115368 | A-Z115368 |
| JOHN DEERE | T26755 | A-T26755 | JOHN DEERE | Z117398 | A-Z117398 |
| JOHN DEERE | TCU12829 | A-TCU12829 | JOHN DEERE | Z20823A | A-Z20823A |
| JOHN DEERE | TCU13749 | A-TCU13749 | JOHN DEERE | Z21113 | A-Z21113 |
| JOHN DEERE | TCU16026 | A-TCU16026 | JOHN DEERE | Z22556 | A-Z22556 |
| JOHN DEERE | TCU16841 | A-TCU16841 | JOHN DEERE | Z22832 | A-Z22832 |
| JOHN DEERE | TCU29452 | A-TCU29452 | JOHN DEERE | Z23086 | A-Z23086 |
| JOHN DEERE | TCU29453 | A-TCU29453 | JOHN DEERE | Z23087 | A-Z23087 |
| JOHN DEERE | TCU29454 | A-TCU29454 | JOHN DEERE | Z23475 | A-Z23475 |
| JOHN DEERE | TCU29455 | A-TCU29455 | JOHN DEERE | Z23476 | A-Z23476 |
| JOHN DEERE | TCU30356 | A-TCU30356 | JOHN DEERE | Z24729 | A-Z24729 |
| JOHN DEERE | TCU30510 | A-TCU30510 | JOHN DEERE | Z24833 | A-Z24833 |
| JOHN DEERE | TCU31132 | A-TCU31132 | JOHN DEERE | Z26628 | A-Z26628 |
| JOHN DEERE | VK648204 | A-VK648204 | JOHN DEERE | Z27710 | A-Z27710 |
| JOHN DEERE | VK648215 | A-VK648215 | JOHN DEERE | Z28339 | A-Z28339 |
| JOHN DEERE | VK648216 | A-VK648216 | JOHN DEERE | Z28842 | A-Z28842 |
| JOHN DEERE | VK648223 | A-VK648223 | JOHN DEERE | Z29962 | A-Z29962 |
| JOHN DEERE | W10389 | A-W10389 | JOHN DEERE | Z30881 | A-Z30881 |
| JOHN DEERE | W14431 | A-W14431 | JOHN DEERE | Z31376 | A-Z31376 |
| JOHN DEERE | W26375 | A-W26375 | JOHN DEERE | Z32173 | A-Z32173 |
| JOHN DEERE | W30582 | A-W30582 | JOHN DEERE | Z32514 | A-Z32514 |
| JOHN DEERE | Y55970 | A-Y55970 | JOHN DEERE | Z33368 | A-Z33368 |
| JOHN DEERE | YC10134 | A-YC10134 | JOHN DEERE | Z35356 | A-Z35356 |
| | | | JOHN DEERE | Z35357 | A-Z35357 |

JOHN DEERE



| OEM | OEM  Part No. | PIX  Part No. | OEM | OEM  Part No. | PIX  Part No. |
|------------|--|--|------------|--|--|
| JOHN DEERE | Z35358 | A-Z35358 | JOHN DEERE | ZY96548 | A-ZY96548 |
| JOHN DEERE | Z36499 | A-Z36499 | JOHN DEERE | ZY96551 | A-ZY96551 |
| JOHN DEERE | Z36770 | A-Z36770 | JOHN DEERE | ZY96558 | A-ZY96558 |
| JOHN DEERE | Z36771 | A-Z36771 | JOHN DEERE | HXE22617 | A-HXE22617 |
| JOHN DEERE | Z37121 | A-Z37121 | JOHN DEERE | HXE54503 | A-HXE54503 |
| JOHN DEERE | Z37476 | A-Z37476 | JOHN DEERE | AXE42095 | A-AXE42095 |
| JOHN DEERE | Z38698 | A-Z38698 | JOHN DEERE | HXE100455 | A-HXE100455 |
| JOHN DEERE | Z38699 | A-Z38699 | JOHN DEERE | HXE107624 | A-HXE107624 |
| JOHN DEERE | Z38708 | A-Z38708 | JOHN DEERE | HXE11117 | A-HXE11117 |
| JOHN DEERE | Z41889 | A-Z41889 | JOHN DEERE | HXE114322 | A-HXE114322 |
| JOHN DEERE | Z44762 | A-Z44762 | JOHN DEERE | HXE124870 | A-HXE124870 |
| JOHN DEERE | Z44937 | A-Z44937 | JOHN DEERE | HXE150557 | A-HXE150557 |
| JOHN DEERE | Z45359 | A-Z45359 | JOHN DEERE | HXE152482 | A-HXE152482 |
| JOHN DEERE | Z45369 | A-Z45369 | JOHN DEERE | HXE22090 | A-HXE22090 |
| JOHN DEERE | Z46463A | A-Z46463A | JOHN DEERE | HXE23801 | A-HXE23801 |
| JOHN DEERE | Z48472 | A-Z48472 | JOHN DEERE | HXE34465 | A-HXE34465 |
| JOHN DEERE | Z48567 | A-Z48567 | JOHN DEERE | HXE40179 | A-HXE40179 |
| JOHN DEERE | Z51089 | A-Z51089 | JOHN DEERE | HXE40946 | A-HXE40946 |
| JOHN DEERE | Z51202 | A-Z51202 | JOHN DEERE | HXE63990 | A-HXE63990 |
| JOHN DEERE | Z51202 | A-Z51202 | JOHN DEERE | HXE65360 | A-HXE65360 |
| JOHN DEERE | Z51708 | A-Z51708 | JOHN DEERE | HXE65361 | A-HXE65361 |
| JOHN DEERE | Z52009 | A-Z52009 | JOHN DEERE | HXE69280 | A-HXE69280 |
| JOHN DEERE | Z53478 | A-Z53478 | JOHN DEERE | HXE72209 | A-HXE72209 |
| JOHN DEERE | Z53515 | A-Z53515 | JOHN DEERE | HXE72281 | A-HXE72281 |
| JOHN DEERE | Z54332 | A-Z54332 | JOHN DEERE | HXE73027 | A-HXE73027 |
| JOHN DEERE | Z55771 | A-Z55771 | JOHN DEERE | HXE73048 | A-HXE73048 |
| JOHN DEERE | Z56313 | A-Z56313 | JOHN DEERE | HXE73530 | A-HXE73530 |
| JOHN DEERE | Z56351 | A-Z56351 | JOHN DEERE | HXE73868 | A-HXE73868 |
| JOHN DEERE | Z56352 | A-Z56352 | JOHN DEERE | HXE74209 | A-HXE74209 |
| JOHN DEERE | Z56829 | A-Z56829 | JOHN DEERE | HXE74439 | A-HXE74439 |
| JOHN DEERE | Z57235 | A-Z57235 | JOHN DEERE | HXE74517 | A-HXE74517 |
| JOHN DEERE | Z58886 | A-Z58886 | JOHN DEERE | HXE74560 | A-HXE74560 |
| JOHN DEERE | Z59255 | A-Z59255 | JOHN DEERE | HXE75054 | A-HXE75054 |
| JOHN DEERE | Z59930 | A-Z59930 | JOHN DEERE | HXE75142 | A-HXE75142 |
| JOHN DEERE | Z62025 | A-Z62025 | JOHN DEERE | HXE76183 | A-HXE76183 |
| JOHN DEERE | Z63322 | A-Z63322 | JOHN DEERE | HXE79558 | A-HXE79558 |
| JOHN DEERE | Z63327 | A-Z63327 | JOHN DEERE | HXE82335 | A-HXE82335 |
| JOHN DEERE | Z65924 | A-Z65924 | JOHN DEERE | HXE86445 | A-HXE86445 |
| JOHN DEERE | Z66787 | A-Z66787 | JOHN DEERE | HXE87482 | A-HXE87482 |
| JOHN DEERE | Z66873 | A-Z66873 | JOHN DEERE | HXE88939 | A-HXE88939 |
| JOHN DEERE | Z67326 | A-Z67326 | JOHN DEERE | HXE94485 | A-HXE94485 |
| JOHN DEERE | Z73506 | A-Z73506 | JOHN DEERE | HXE94488 | A-HXE94488 |
| JOHN DEERE | Z75245 | A-Z75245 | JOHN DEERE | HXE95150 | A-HXE95150 |
| JOHN DEERE | Z75246 | A-Z75246 | JOHN DEERE | HXE95151 | A-HXE95151 |
| JOHN DEERE | Z77222 | A-Z77222 | JOHN DEERE | HXE95511 | A-HXE95511 |
| JOHN DEERE | Z78860 | A-Z78860 | JOHN DEERE | HXE98150 | A-HXE98150 |
| JOHN DEERE | Z81070 | A-Z81070 | JOHN DEERE | HXE99294 | A-HXE99294 |
| JOHN DEERE | Z9281H | A-Z9281H | JOHN DEERE | R551022 | A-R551022 |
| JOHN DEERE | ZX64616 | A-ZX64616 | JOHN DEERE | Z81937 | A-Z81937 |
| JOHN DEERE | ZY86859 | A-ZY86859 | JOHN DEERE | ZY94115 | A-ZY94115 |
| JOHN DEERE | ZY94047 | A-ZY94047 | JOHN DEERE | ZY95337 | A-ZY95337 |

JOHN DEERE

| OEM | OEM  Part No. | PIX  Part No. | OEM | OEM  Part No. | PIX  Part No. |
|------------|--|--|------------|--|--|
| JOHN DEERE | R533664 | A-R533664 | JOHN DEERE | FH318410 | A-FH318410 |
| JOHN DEERE | R536677 | A-R536677 | JOHN DEERE | H215388 | A-H215388 |
| JOHN DEERE | R551297 | A-R551297 | JOHN DEERE | R245222 | A-R245222 |
| JOHN DEERE | L214296 | A-L214296 | JOHN DEERE | R265241 | A-R265241 |
| JOHN DEERE | L223026 | A-L223026 | JOHN DEERE | R307304 | A-R307304 |
| JOHN DEERE | L23014 | A-L23014 | JOHN DEERE | R334797 | A-R334797 |
| JOHN DEERE | R269265 | A-R269265 | JOHN DEERE | R87152 | A-R87152 |
| JOHN DEERE | R270968 | A-R270968 | JOHN DEERE | AXE34908 | A-AXE34908 |
| JOHN DEERE | R275172 | A-R275172 | JOHN DEERE | HXE147321 | A-HXE147321 |
| JOHN DEERE | R334800 | A-R334800 | JOHN DEERE | HXE153380 | A-HXE153380 |
| JOHN DEERE | R533705 | A-R533705 | JOHN DEERE | HXE88564 | A-HXE88564 |
| JOHN DEERE | R551298 | A-R551298 | JOHN DEERE | H128010 | A-H128010 |
| JOHN DEERE | R561692 | A-R561692 | JOHN DEERE | H146636 | A-H146636 |
| JOHN DEERE | R563475 | A-R563475 | JOHN DEERE | H156541 | A-H156541 |
| JOHN DEERE | T197521 | A-T197521 | JOHN DEERE | H201334 | A-H201334 |
| JOHN DEERE | AT232955 | A-AT232955 | JOHN DEERE | PH125380 | A-PH125380 |





KPAB

| OEM | OEM  Part No. | PIX  Part No. |
|------|--|--|
| KPAB | 904020 | A-904020 |
| KPAB | 904022 | A-904022 |
| KPAB | 904030 | A-904030 |
| KPAB | 904033 | A-904033 |
| KPAB | 904036 | A-904036 |
| KPAB | 904041 | A-904041 |
| KPAB | 904042 | A-904042 |
| KPAB | 904043 | A-904043 |
| KPAB | 904045 | A-904045 |
| KPAB | 904047 | A-904047 |



KRONE

| | | |
|-------|---------|-----------|
| KRONE | 2150791 | A-2150791 |
| KRONE | 2168800 | A-2168800 |
| KRONE | 2211880 | A-2211880 |
| KRONE | 2240410 | A-2240410 |
| KRONE | 2253560 | A-2253560 |
| KRONE | 2253610 | A-2253610 |
| KRONE | 2266930 | A-2266930 |
| KRONE | 2279090 | A-2279090 |
| KRONE | 2279101 | A-2279101 |
| KRONE | 2279251 | A-2279251 |
| KRONE | 2282321 | A-2282321 |
| KRONE | 2282330 | A-2282330 |
| KRONE | 2282340 | A-2282340 |
| KRONE | 2282350 | A-2282350 |
| KRONE | 2282360 | A-2282360 |
| KRONE | 2282430 | A-2282430 |
| KRONE | 9215002 | A-9215002 |
| KRONE | 9215010 | A-9215010 |
| KRONE | 9215030 | A-9215030 |
| KRONE | 9215040 | A-9215040 |
| KRONE | 9215050 | A-9215050 |
| KRONE | 9215060 | A-9215060 |
| KRONE | 9215070 | A-9215070 |
| KRONE | 9215090 | A-9215090 |
| KRONE | 9215101 | A-9215101 |
| KRONE | 9215102 | A-9215102 |
| KRONE | 9215110 | A-9215110 |
| KRONE | 9215121 | A-9215121 |
| KRONE | 9215130 | A-9215130 |
| KRONE | 9215140 | A-9215140 |
| KRONE | 9215151 | A-9215151 |
| KRONE | 9215161 | A-9215161 |
| KRONE | 9215181 | A-9215181 |
| KRONE | 9215190 | A-9215190 |
| KRONE | 9215221 | A-9215221 |



KRONE

| OEM | OEM  Part No. | PIX  Part No. |
|-------|--|--|
| KRONE | 9215232 | A-9215232 |
| KRONE | 9215241 | A-9215241 |
| KRONE | 9215251 | A-9215251 |
| KRONE | 9215260 | A-9215260 |
| KRONE | 9215270 | A-9215270 |
| KRONE | 9215280 | A-9215280 |
| KRONE | 9215290 | A-9215290 |
| KRONE | 9215300 | A-9215300 |
| KRONE | 9215310 | A-9215310 |
| KRONE | 9215320 | A-9215320 |
| KRONE | 9215330 | A-9215330 |
| KRONE | 9215360 | A-9215360 |
| KRONE | 9215370 | A-9215370 |
| KRONE | 9215380 | A-9215380 |
| KRONE | 9215390 | A-9215390 |
| KRONE | 9215400 | A-9215400 |
| KRONE | 9215412 | A-9215412 |
| KRONE | 9215420 | A-9215420 |
| KRONE | 9215450 | A-9215450 |
| KRONE | 9215470 | A-9215470 |
| KRONE | 9215520 | A-9215520 |
| KRONE | 9215530 | A-9215530 |
| KRONE | 9215540 | A-9215540 |
| KRONE | 9215550 | A-9215550 |
| KRONE | 9215560 | A-9215560 |
| KRONE | 9215570 | A-9215570 |
| KRONE | 9215861 | A-9215861 |
| KRONE | 9215931 | A-9215931 |
| KRONE | 9215962 | A-9215962 |
| KRONE | 9215981 | A-9215981 |
| KRONE | 9216000 | A-9216000 |
| KRONE | 9216010 | A-9216010 |
| KRONE | 9216030 | A-9216030 |
| KRONE | 9216070 | A-9216070 |





KUHN

| OEM | OEM  Part No. | PIX  Part No. |
|------|--|--|
| KUHN | 83101059 | A-83101059 |
| KUHN | 83101067 | A-83101067 |
| KUHN | 83101252 | A-83101252 |
| KUHN | 83101253 | A-83101253 |
| KUHN | 83101270 | A-83101270 |
| KUHN | 83101286 | A-83101286 |
| KUHN | 83101656 | A-83101656 |
| KUHN | 83101658 | A-83101658 |
| KUHN | 83101670 | A-83101670 |
| KUHN | 83101672 | A-83101672 |
| KUHN | 83101673 | A-83101673 |
| KUHN | 83101680 | A-83101680 |
| KUHN | 83101681 | A-83101681 |
| KUHN | 83101682 | A-83101682 |
| KUHN | 83101687 | A-83101687 |
| KUHN | 83101688 | A-83101688 |
| KUHN | 83101764 | A-83101764 |
| KUHN | 83101778 | A-83101778 |
| KUHN | 83101782 | A-83101782 |
| KUHN | 83101785 | A-83101785 |
| KUHN | 83101791 | A-83101791 |
| KUHN | 83101792 | A-83101792 |
| KUHN | 83101795 | A-83101795 |
| KUHN | 83101796 | A-83101796 |
| KUHN | 83101797 | A-83101797 |
| KUHN | 83101798 | A-83101798 |
| KUHN | 83111677 | A-83111677 |
| KUHN | 83111679 | A-83111679 |
| KUHN | 83111682 | A-83111682 |
| KUHN | 83111683 | A-83111683 |





KVERNELAND

| OEM | OEM  Part No. | PIX  Part No. |
|------------|--|--|
| KVERNELAND | 0000930 | A-0000930 |
| KVERNELAND | 0000930D | A-0000930D |
| KVERNELAND | 0000930M | A-0000930M |
| KVERNELAND | 0000939 | A-0000939 |
| KVERNELAND | 0000942 | A-0000942 |
| KVERNELAND | 0000942D | A-0000942D |
| KVERNELAND | 0000943 | A-0000943 |
| KVERNELAND | 0000944 | A-0000944 |
| KVERNELAND | 0001099 | A-0001099 |
| KVERNELAND | 0001108 | A-0001108 |
| KVERNELAND | 0001160 | A-0001160 |
| KVERNELAND | 0001218 | A-0001218 |
| KVERNELAND | 0001224 | A-0001224 |
| KVERNELAND | 1142085 | A-01142085 |
| KVERNELAND | 37771407 | A-37771407 |
| KVERNELAND | 43301603 | A-43301603 |
| KVERNELAND | 43303407 | A-43303407 |
| KVERNELAND | 43303410 | A-43303410 |
| KVERNELAND | 43303412 | A-43303412 |
| KVERNELAND | 43303413 | A-43303413 |
| KVERNELAND | 43303417 | A-43303417 |
| KVERNELAND | 43303418 | A-43303418 |
| KVERNELAND | 43303420 | A-43303420 |
| KVERNELAND | 43303424 | A-43303424 |
| KVERNELAND | 43303426 | A-43303426 |
| KVERNELAND | 43303427 | A-43303427 |
| KVERNELAND | 43303429 | A-43303429 |
| KVERNELAND | 43303432 | A-43303432 |
| KVERNELAND | 43303434 | A-43303434 |
| KVERNELAND | 99201011 | A-99201011 |
| KVERNELAND | 99201014 | A-99201014 |
| KVERNELAND | 99201017 | A-99201017 |
| KVERNELAND | 99201020 | A-99201020 |
| KVERNELAND | 99201032 | A-99201032 |
| KVERNELAND | 99201038 | A-99201038 |
| KVERNELAND | 99201040 | A-99201040 |
| KVERNELAND | 99201411 | A-99201411 |
| KVERNELAND | 99201412 | A-99201412 |
| KVERNELAND | 99201413 | A-99201413 |
| KVERNELAND | 99201414 | A-99201414 |
| KVERNELAND | 99201418 | A-99201418 |
| KVERNELAND | 99201420 | A-99201420 |
| KVERNELAND | 99201422 | A-99201422 |
| KVERNELAND | 99201424 | A-99201424 |
| KVERNELAND | 99201510 | A-99201510 |
| KVERNELAND | 99202008 | A-99202008 |
| KVERNELAND | 99202009 | A-99202009 |





KVERNELAND

| OEM | OEM  Part No. | PIX  Part No. | OEM | OEM  Part No. | PIX  Part No. |
|------------|--|--|------------|--|--|
| KVERNELAND | 99202011 | A-99202011 | KVERNELAND | 99203010 | A-99203010 |
| KVERNELAND | 99202012 | A-99202012 | KVERNELAND | 99203012 | A-99203012 |
| KVERNELAND | 99202013 | A-99202013 | KVERNELAND | 99203014 | A-99203014 |
| KVERNELAND | 99202014 | A-99202014 | KVERNELAND | 99203015 | A-99203015 |
| KVERNELAND | 99202015 | A-99202015 | KVERNELAND | 99203016 | A-99203016 |
| KVERNELAND | 99202016 | A-99202016 | KVERNELAND | 99203017 | A-99203017 |
| KVERNELAND | 99202017 | A-99202017 | KVERNELAND | 99203018 | A-99203018 |
| KVERNELAND | 99202018 | A-99202018 | KVERNELAND | 99203019 | A-99203019 |
| KVERNELAND | 99202019 | A-99202019 | KVERNELAND | 99203020 | A-99203020 |
| KVERNELAND | 99202021 | A-99202021 | KVERNELAND | 99203021 | A-99203021 |
| KVERNELAND | 99202022 | A-99202022 | KVERNELAND | 99203022 | A-99203022 |
| KVERNELAND | 99202024 | A-99202024 | KVERNELAND | 99203023 | A-99203023 |
| KVERNELAND | 99202025 | A-99202025 | KVERNELAND | 99203024 | A-99203024 |
| KVERNELAND | 99202026 | A-99202026 | KVERNELAND | 99203025 | A-99203025 |
| KVERNELAND | 99202027 | A-99202027 | KVERNELAND | 99203026 | A-99203026 |
| KVERNELAND | 99202028 | A-99202028 | KVERNELAND | 99203027 | A-99203027 |
| KVERNELAND | 99202031 | A-99202031 | KVERNELAND | 99203029 | A-99203029 |
| KVERNELAND | 99202032 | A-99202032 | KVERNELAND | 99203038 | A-99203038 |
| KVERNELAND | 99202035 | A-99202035 | KVERNELAND | 99203039 | A-99203039 |
| KVERNELAND | 99202036 | A-99202036 | KVERNELAND | 99203042 | A-99203042 |
| KVERNELAND | 99202038 | A-99202038 | KVERNELAND | 99203045 | A-99203045 |
| KVERNELAND | 99202039 | A-99202039 | KVERNELAND | 99203046 | A-99203046 |
| KVERNELAND | 99202040 | A-99202040 | KVERNELAND | 99203048 | A-99203048 |
| KVERNELAND | 99202041 | A-99202041 | KVERNELAND | 99203050 | A-99203050 |
| KVERNELAND | 99202042 | A-99202042 | KVERNELAND | 99203052 | A-99203052 |
| KVERNELAND | 99202062 | A-99202062 | KVERNELAND | 99203056 | A-99203056 |
| KVERNELAND | 99202063 | A-99202063 | KVERNELAND | 99203063 | A-99203063 |
| KVERNELAND | 99202220 | A-99202220 | KVERNELAND | 99203082 | A-99203082 |
| KVERNELAND | 99202322 | A-99202322 | KVERNELAND | 99203083 | A-99203083 |
| KVERNELAND | 99202325 | A-99202325 | KVERNELAND | 99203085 | A-99203085 |
| KVERNELAND | A99202409 | A-99202409 | KVERNELAND | 99203086 | A-99203086 |
| KVERNELAND | A99202410 | A-99202410 | KVERNELAND | 99203087 | A-99203087 |
| KVERNELAND | 99202412 | A-99202412 | KVERNELAND | 99203088 | A-99203088 |
| KVERNELAND | 99202413 | A-99202413 | KVERNELAND | 99203090 | A-99203090 |
| KVERNELAND | 99202415 | A-99202415 | KVERNELAND | 99203091 | A-99203091 |
| KVERNELAND | 99202420 | A-99202420 | KVERNELAND | 99203093 | A-99203093 |
| KVERNELAND | 99202423 | A-99202423 | KVERNELAND | 99203203 | A-99203203 |
| KVERNELAND | 99202424 | A-99202424 | KVERNELAND | 99203204 | A-99203204 |
| KVERNELAND | 99202425 | A-99202425 | KVERNELAND | 99203208 | A-99203208 |
| KVERNELAND | 99202428 | A-99202428 | KVERNELAND | 99203210 | A-99203210 |
| KVERNELAND | 99202429 | A-99202429 | KVERNELAND | 99203211 | A-99203211 |
| KVERNELAND | 99202430 | A-99202430 | KVERNELAND | 99203212 | A-99203212 |
| KVERNELAND | 99202431 | A-99202431 | KVERNELAND | 99203213 | A-99203213 |
| KVERNELAND | 99202433 | A-99202433 | KVERNELAND | 99203215 | A-99203215 |
| KVERNELAND | 99203005 | A-99203005 | KVERNELAND | 99203216 | A-99203216 |
| KVERNELAND | 99203006 | A-99203006 | KVERNELAND | 99203218 | A-99203218 |
| KVERNELAND | 99203008 | A-99203008 | KVERNELAND | 99203245 | A-99203245 |





KUHN

| OEM | OEM  Part No. | PIX  Part No. | OEM | OEM  Part No. | PIX  Part No. |
|------------|--|--|------------|--|--|
| KVERNELAND | 99203250 | A-99203250 | KVERNELAND | ND96053 | A-ND96053 |
| KVERNELAND | 99203310 | A-99203310 | KVERNELAND | ND96063 | A-ND96063 |
| KVERNELAND | 99203315 | A-99203315 | KVERNELAND | ND96067 | A-ND96067 |
| KVERNELAND | 99203320 | A-99203320 | KVERNELAND | ND96068 | A-ND96068 |
| KVERNELAND | 99203330 | A-99203330 | KVERNELAND | ND96070 | A-ND96070 |
| KVERNELAND | 99203331 | A-99203331 | KVERNELAND | ND96074 | A-ND96074 |
| KVERNELAND | 99203332 | A-99203332 | KVERNELAND | ND96075 | A-ND96075 |
| KVERNELAND | 99203333 | A-99203333 | KVERNELAND | ND96078 | A-ND96078 |
| KVERNELAND | 99203335 | A-99203335 | KVERNELAND | ND96082 | A-ND96082 |
| KVERNELAND | 99203415 | A-99203415 | KVERNELAND | ND96083 | A-ND96083 |
| KVERNELAND | 99203418 | A-99203418 | KVERNELAND | ND96084 | A-ND96084 |
| KVERNELAND | 99203419 | A-99203419 | KVERNELAND | ND96085 | A-ND96085 |
| KVERNELAND | 99203422 | A-99203422 | KVERNELAND | ND96087 | A-ND96087 |
| KVERNELAND | 99204062 | A-99204062 | KVERNELAND | ND96089 | A-ND96089 |
| KVERNELAND | 99204076 | A-99204076 | KVERNELAND | ND96090 | A-ND96090 |
| KVERNELAND | 99207010 | A-99207010 | KVERNELAND | ND96091 | A-ND96091 |
| KVERNELAND | 99207113 | A-99207113 | KVERNELAND | ND96096 | A-ND96096 |
| KVERNELAND | 99207225 | A-99207225 | KVERNELAND | ND96108 | A-ND96108 |
| KVERNELAND | AC494745 | A-A-C494745 | KVERNELAND | ND96109 | A-ND96109 |
| KVERNELAND | AC494836 | A-A-C494836 | KVERNELAND | ND9629 | A-ND9629 |
| KVERNELAND | AC690011 | A-AC690011 | KVERNELAND | ND9630 | A-ND9630 |
| KVERNELAND | AC690071 | A-AC690071 | KVERNELAND | ND9704 | A-ND9704 |
| KVERNELAND | AC690081 | A-AC690081 | KVERNELAND | ND9732 | A-ND9732 |
| KVERNELAND | AC690115 | A-AC690115 | KVERNELAND | ND9775 | A-ND9775 |
| KVERNELAND | AC690123 | A-AC690123 | KVERNELAND | ND9909 | A-ND9909 |
| KVERNELAND | AC690131 | A-AC690131 | KVERNELAND | ND9928 | A-ND9928 |
| KVERNELAND | AC690132 | A-AC690132 | KVERNELAND | ND9958 | A-ND9958 |
| KVERNELAND | AC690137 | A-AC690137 | KVERNELAND | RG00035618 | A-RG00035618 |
| KVERNELAND | AC690138 | A-AC690138 | KVERNELAND | RG00037276 | A-RG00037276 |
| KVERNELAND | AC690140 | A-A-C690140 | KVERNELAND | RG00040590 | A-RG00040590 |
| KVERNELAND | AC690149 | A-AC690149 | KVERNELAND | RG00040922 | A-RG00040922 |
| KVERNELAND | AC690150 | A-AC690150 | KVERNELAND | RG00040955 | A-RG00040955 |
| KVERNELAND | AC690154 | A-AC690154 | | | |
| KVERNELAND | AC690156 | A-AC690156 | | | |
| KVERNELAND | AC690164 | A-AC690164 | | | |
| KVERNELAND | AC690181 | A-AC690181 | | | |
| KVERNELAND | AC690201 | A-AC690201 | | | |
| KVERNELAND | AC690202 | A-AC690202 | | | |
| KVERNELAND | ND9198 | A-ND9198 | | | |
| KVERNELAND | ND9240 | A-ND9240 | | | |
| KVERNELAND | ND9257 | A-ND9257 | | | |
| KVERNELAND | ND96001 | A-ND96001 | | | |
| KVERNELAND | ND96006 | A-ND96006 | | | |
| KVERNELAND | ND96008 | A-ND96008 | | | |
| KVERNELAND | ND96016 | A-ND96016 | | | |
| KVERNELAND | ND96023 | A-ND96023 | | | |
| KVERNELAND | ND96029 | A-ND96029 | | | |





LAVERDA

| OEM | OEM  Part No. | PIX  Part No. | OEM | OEM  Part No. | PIX  Part No. |
|---------|--|--|---------|--|--|
| LAVERDA | 1909636 | A-1909636 | LAVERDA | 344311418K | A-344311418K |
| LAVERDA | 311127 | A-311127 | LAVERDA | 4310226 | A-4310226 |
| LAVERDA | 311134 | A-311134 | LAVERDA | 4311126 | A-4311126 |
| LAVERDA | 311222 | A-311222 | LAVERDA | 4311127 | A-4311127 |
| LAVERDA | 311230 | A-311230 | LAVERDA | 4311134 | A-4311134 |
| LAVERDA | 311316 | A-311316 | LAVERDA | 4311137 | A-4311137 |
| LAVERDA | 311318 | A-311318 | LAVERDA | 4311212 | A-4311212 |
| LAVERDA | 312128 | A-312128 | LAVERDA | 4311217 | A-4311217 |
| LAVERDA | 323019750 | A-323019750 | LAVERDA | 4311218 | A-4311218 |
| LAVERDA | 340311127 | A-340311127 | LAVERDA | 4311220 | A-4311220 |
| LAVERDA | 340432239 | A-340432239 | LAVERDA | 4311221 | A-4311221 |
| LAVERDA | 340432433 | A-340432433 | LAVERDA | 4311222 | A-4311222 |
| LAVERDA | 340432436 | A-340432436 | LAVERDA | 4311226 | A-4311226 |
| LAVERDA | 340432437 | A-340432437 | LAVERDA | 4311227 | A-4311227 |
| LAVERDA | 340432438 | A-340432438 | LAVERDA | 4311314 | A-4311314 |
| LAVERDA | 340433133 | A-340433133 | LAVERDA | 4311318 | A-4311318 |
| LAVERDA | 340433157 | A-340433157 | LAVERDA | 4311319 | A-4311319 |
| LAVERDA | 340433174 | A-340433174 | LAVERDA | 4311418 | A-4311418 |
| LAVERDA | 340433189 | A-340433189 | LAVERDA | 4311418K | A-4311418K |
| LAVERDA | 340433192 | A-340433192 | LAVERDA | 432232 | A-432232 |
| LAVERDA | 340433237 | A-340433237 | LAVERDA | 432239 | A-432239 |
| LAVERDA | 340433243 | A-340433243 | LAVERDA | 43224 | A-43224 |
| LAVERDA | 340433305 | A-340433305 | LAVERDA | 432243 | A-432243 |
| LAVERDA | 340433308 | A-340433308 | LAVERDA | 432246 | A-432246 |
| LAVERDA | 340433406 | A-340433406 | LAVERDA | 432250 | A-432250 |
| LAVERDA | 340433408 | A-340433408 | LAVERDA | 432436 | A-432436 |
| LAVERDA | 340433413 | A-340433413 | LAVERDA | 432437 | A-432437 |
| LAVERDA | 340433416 | A-340433416 | LAVERDA | 432438 | A-432438 |
| LAVERDA | 340433431 | A-340433431 | LAVERDA | 433045 | A-433045 |
| LAVERDA | 340433442 | A-340433442 | LAVERDA | 433129 | A-433129 |
| LAVERDA | 340433450 | A-340433450 | LAVERDA | 433131 | A-433131 |
| LAVERDA | 340433472 | A-340433472 | LAVERDA | 433132 | A-433132 |
| LAVERDA | 340433473 | A-340433473 | LAVERDA | 433133 | A-433133 |
| LAVERDA | 340433532 | A-340433532 | LAVERDA | 433134 | A-433134 |
| LAVERDA | 340433963 | A-340433963 | Laverda | 433138 | A-433138 |
| LAVERDA | 340434245 | A-340434245 | LAVERDA | 433143 | A-433143 |
| LAVERDA | 340434250 | A-340434250 | LAVERDA | 433144 | A-433144 |
| LAVERDA | 340435117 | A-340435117 | LAVERDA | 433151 | A-433151 |
| LAVERDA | 340435125 | A-340435125 | LAVERDA | 433154 | A-433154 |
| LAVERDA | 340435132 | A-340435132 | LAVERDA | 433157 | A-433157 |
| LAVERDA | 340-435-147 | A-340-435-147 | LAVERDA | 433162 | A-433162 |
| LAVERDA | 344310110 | A-344310110 | LAVERDA | 433176 | A-433176 |
| LAVERDA | 344310226 | A-344310226 | LAVERDA | 433179 | A-433179 |
| LAVERDA | 344311127K | A-344311127K | LAVERDA | 433181 | A-433181 |
| LAVERDA | 344311212K | A-344311212K | LAVERDA | 433182 | A-433182 |
| LAVERDA | 344311225 | A-344311225 | LAVERDA | 433184 | A-433184 |
| LAVERDA | 344311315 | A-344311315 | LAVERDA | 433189 | A-433189 |





LAVERDA

| OEM | OEM  Part No. | PIX  Part No. | OEM | OEM  Part No. | PIX  Part No. |
|---------|--|--|---------|--|--|
| LAVERDA | 433190 | A-433190 | LAVERDA | 433456 | A-433456 |
| LAVERDA | 433191 | A-433191 | LAVERDA | 433457 | A-433457 |
| LAVERDA | 433197 | A-433197 | LAVERDA | 433458 | A-433458 |
| LAVERDA | 433198 | A-433198 | LAVERDA | 433465 | A-433465 |
| LAVERDA | 433223 | A-433223 | LAVERDA | 433467 | A-433467 |
| LAVERDA | 433236 | A-433236 | LAVERDA | 433469 | A-433469 |
| LAVERDA | 433239 | A-433239 | LAVERDA | 433470 | A-433470 |
| LAVERDA | 433243 | A-433243 | LAVERDA | 433471 | A-433471 |
| LAVERDA | 433244 | A-433244 | LAVERDA | 433472 | A-433472 |
| LAVERDA | 433252 | A-433252 | LAVERDA | 433474 | A-433474 |
| LAVERDA | 433253 | A-433253 | LAVERDA | 433475 | A-433475 |
| LAVERDA | 433256 | A-433256 | LAVERDA | 4334751 | A-4334751 |
| LAVERDA | 433257 | A-433257 | LAVERDA | 433475K | A-433475K |
| LAVERDA | 433262 | A-433262 | LAVERDA | 433539 | A-433539 |
| LAVERDA | 433268 | A-433268 | LAVERDA | 433961 | A-433961 |
| LAVERDA | 433272 | A-433272 | LAVERDA | 433963 | A-433963 |
| LAVERDA | 433274 | A-433274 | LAVERDA | 433964 | A-433964 |
| LAVERDA | 433281 | A-433281 | LAVERDA | 433970 | A-433970 |
| LAVERDA | 433283 | A-433283 | LAVERDA | 433980 | A-433980 |
| LAVERDA | 433289 | A-433289 | LAVERDA | 433983 | A-433983 |
| LAVERDA | 433290 | A-433290 | LAVERDA | 433984 | A-433984 |
| LAVERDA | 433305 | A-433305 | LAVERDA | 434138 | A-434138 |
| LAVERDA | 433308 | A-433308 | LAVERDA | 4351146 | A-4351146 |
| LAVERDA | 433316 | A-433316 | LAVERDA | 435117 | A-435117 |
| LAVERDA | 433405 | A-433405 | LAVERDA | 435120 | A-435120 |
| LAVERDA | 433406 | A-433406 | LAVERDA | 435124 | A-435124 |
| LAVERDA | 433409 | A-433409 | LAVERDA | 435130 | A-435130 |
| LAVERDA | 433410 | A-433410 | LAVERDA | 435131 | A-435131 |
| LAVERDA | 433412 | A-433412 | LAVERDA | 435131K | A-435131K |
| LAVERDA | 433413 | A-433413 | LAVERDA | 435135 | A-435135 |
| LAVERDA | 433414 | A-433414 | LAVERDA | 435138 | A-435138 |
| LAVERDA | 433415 | A-433415 | LAVERDA | 435146 | A-435146 |
| LAVERDA | 433418 | A-433418 | LAVERDA | 435147 | A-435147 |
| LAVERDA | 433419 | A-433419 | LAVERDA | 435150 | A-435150 |
| LAVERDA | 433422 | A-433422 | Laverda | 435151 | A-435151 |
| LAVERDA | 433423 | A-433423 | LAVERDA | 435152 | A-435152 |
| LAVERDA | 433424 | A-433424 | LAVERDA | 435158 | A-435158 |
| LAVERDA | 433425 | A-433425 | LAVERDA | 4898546 | A-4898546 |
| LAVERDA | 433427 | A-433427 | LAVERDA | 70108 | A-70108 |
| LAVERDA | 433428 | A-433428 | LAVERDA | 8822704 | A-8822704 |
| LAVERDA | 433430 | A-433430 | | | |
| LAVERDA | 433431 | A-433431 | | | |
| LAVERDA | 433432 | A-433432 | | | |
| LAVERDA | 433441 | A-433441 | | | |
| LAVERDA | 433446 | A-433446 | | | |
| LAVERDA | 433453 | A-433453 | | | |
| LAVERDA | 433455 | A-433455 | | | |





MASSEY FERGUSON (MF)

| OEM | OEM  Part No. | PIX  Part No. | OEM | OEM  Part No. | PIX  Part No. |
|-----|--|--|-----|--|--|
| MF | 059169R1 | A-059169R1 | MF | 144720M1 | A-144720M1 |
| MF | 065881T1 | A-065881T1 | MF | 1447778M91 | A-1447778M91 |
| MF | 1008980M1 | A-1008980M1 | MF | 147366M1 | A-147366M1 |
| MF | 1012134M1 | A-1012134M1 | MF | 1480826 | A-1480826 |
| MF | 1014342M1 | A-1014342M1 | MF | 1480826M1 | A-1480826M1 |
| MF | 1015003M1 | A-1015003M1 | MF | 1483277M1 | A-1483277M1 |
| MF | 1027577M91 | A-1027577M91 | MF | 1483372M1 | A-1483372M1 |
| MF | 1030912M91 | A-1030912M91 | MF | 1483881 | A-1483881 |
| MF | 1032843M1 | A-1032843M1 | MF | 1483882M1 | A-1483882M1 |
| MF | 1033077M1 | A-1033077M1 | MF | 1483883 | A-1483883 |
| MF | 1033078M1 | A-1033078M1 | MF | 1603701 | A-1603701 |
| MF | 1033137M1 | A-1033137M1 | MF | 1604055M1 | A-1604055M1 |
| MF | 1033198M1 | A-1033198M1 | MF | 1604524M1 | A-1604524M1 |
| MF | 1033376M1 | A-1033376M1 | MF | 1614333M1 | A-1614333M1 |
| MF | 1033451M1 | A-1033451M1 | MF | 1615254 | A-1615254 |
| MF | 1033685M1 | A-1033685M1 | MF | 1615333 | A-1615333 |
| MF | 1033731M1 | A-1033731M1 | MF | 1615333M | A-1615333M |
| MF | 1033813M1 | A-1033813M1 | MF | 1615715M1 | A-1615715M1 |
| MF | 1034188M1 | A-1034188M1 | MF | 1616477 | A-1616477 |
| MF | 1034707M1 | A-1034707M1 | MF | 1616477M1 | A-1616477M1 |
| MF | 1035667M1 | A-1035667M1 | MF | 1616714 | A-1616714 |
| MF | 1035690M1 | A-1035690M1 | MF | 1616714M1 | A-1616714M1 |
| MF | 1037667M1 | A-1037667M1 | MF | 1616715 | A-1616715 |
| MF | 1039570M1 | A-1039570M1 | MF | 1682684M1 | A-1682684M1 |
| MF | 1041487M1 | A-1041487M1 | MF | 1686614M91 | A-1686614M91 |
| MF | 1041598M1 | A-1041598M1 | MF | 1691764M1 | A-1691764M1 |
| MF | 1041614M1 | A-1041614M1 | MF | 1720255 | A-1720255 |
| MF | 1041621M1 | A-1041621M1 | MF | 1720647M1 | A-1720647M1 |
| MF | 1041658M1 | A-1041658M1 | MF | 1720674M1 | A-1720674M1 |
| MF | 1041659M1 | A-1041659M1 | MF | 1722836M1 | A-1722836M1 |
| MF | 1053399M1 | A-1053399M1 | MF | 1874973M1 | A-1874973M1 |
| MF | 1056409M1 | A-1056409M1 | MF | 195432M1 | A-195432M1 |
| MF | 1056423M1 | A-1056423M1 | MF | 197-6291 | A-197-6291 |
| MF | 1056877M1 | A-1056877M1 | MF | 200327M1 | A-200327M1 |
| MF | 1056914M1 | A-1056914M1 | MF | 200557M1 | A-200557M1 |
| MF | 1175125104 | A-1175-125-104.00 | MF | 201900M1 | A-201900M1 |
| MF | 1175-125-104.00 | A-1175-125-104.00 | MF | 202242M2 | A-202242M2 |
| MF | 140259M1 | A-140259M1 | MF | 202336M1 | A-202336M1 |
| MF | 140260M1 | A-140260M1 | MF | 203415M1 | A-203415M1 |
| MF | 141485M1 | A-141485M1 | MF | 204618M1 | A-204618M1 |
| MF | 141515M1 | A-141515M1 | MF | 210627M1 | A-210627M1 |
| MF | 141653M1 | A-141653M1 | MF | 210628C1 | A-210628C1 |
| MF | 141654M1 | A-141654M1 | MF | 210635M1 | A-210635M1 |
| MF | 141883M1 | A-141883M1 | MF | 210810M1 | A-210810M1 |
| MF | 141899M1 | A-141899M1 | MF | 211097M1 | A-211097M1 |
| MF | 1445437M1 | A-1445437M1 | MF | 211666M1 | A-211666M1 |
| MF | 1446201M1 | A-1446201M1 | MF | 213008M1 | A-213008M1 |





MASSEY FERGUSON (MF)

| OEM | OEM  Part No. | PIX  Part No. | OEM | OEM  Part No. | PIX  Part No. |
|-----|--|--|-----|--|--|
| MF | 213850M1 | A-213850M1 | MF | 2614A158 | A-2614A158 |
| MF | 216286M1 | A-216286M1 | MF | 2614B145 | A-2614B145 |
| MF | 216897M1 | A-216897M1 | MF | 2614B650 | A-2614B650 |
| MF | 220773M1 | A-220773M1 | MF | 2727160M2 | A-2727160M2 |
| MF | 222295M1 | A-222295M1 | MF | 273757 | A-273757 |
| MF | 222347M1 | A-222347M1 | MF | 273757M1 | A-273757M1 |
| MF | 222666M1 | A-222666M1 | MF | 274252M91 | A-274252M91 |
| MF | 222882M1 | A-222882M1 | MF | 2826795M1 | A-2826795M1 |
| MF | 222917M1 | A-222917M1 | MF | 2827362M3 | A-2827362M3 |
| MF | 223006M1 | A-223006M1 | MF | 282779M1 | A-282779M1 |
| MF | 226848 | A-226848 | MF | 283080M1 | A-283080M1 |
| MF | 226848M1 | A-226848M1 | MF | 2833904M2 | A-2833904M2 |
| MF | 227978M1 | A-227978M1 | MF | 2833904M3 | A-2833904M3 |
| MF | 227986 | A-227986 | MF | 2834466M1 | A-2834466M1 |
| MF | 227986M1 | A-227986M1 | MF | 2835234M1 | A-2835234M1 |
| MF | 228113M1 | A-228113M1 | MF | 2835857M1 | A-2835857M1 |
| MF | 228147M9 | A-228147M9 | MF | 2835858M1 | A-2835858M1 |
| MF | 228147M91 | A-228147M91 | MF | 2837191M1 | A-2837191M1 |
| MF | 228722M1 | A-228722M1 | MF | 2839975M1 | A-2839975M1 |
| MF | 228813 | A-228813 | MF | 2839978M1 | A-2839978M1 |
| MF | 229097M1 | A-229097M1 | MF | 3021546M1 | A-3021546M1 |
| MF | 229458M1 | A-229458M1 | MF | 3034474 | A-3034474 |
| MF | 229863M1 | A-229863M1 | MF | 3034474M1 | A-3034474M1 |
| MF | 230097M1 | A-230097M1 | MF | 3055094M1 | A-3055094M1 |
| MF | 230350M1 | A-230350M1 | MF | 3098153M1 | A-3098153M1 |
| MF | 230356M2 | A-230356M2 | MF | 3098211 | A-3098211 |
| MF | 2318 | A-2318 | MF | 3098212M1 | A-3098212M1 |
| MF | 232511M2 | A-232511M2 | MF | 3098212M2 | A-3098212M2 |
| MF | 233124 | A-233124 | MF | 3099082 | A-3099082 |
| MF | 233124M1 | A-233124M1 | MF | 3099082M1 | A-3099082M1 |
| MF | 233213M2 | A-233213M2 | MF | 3099829M1 | A-3099829M1 |
| MF | 233950 | A-233950 | MF | 3101337M1 | A-3101337M1 |
| MF | 234995M1 | A-234995M1 | MF | 31240417 | A-31-240417 |
| MF | 235199M1 | A-235199M1 | MF | 31244952 | A-31-244952 |
| MF | 236670M1 | A-236670M1 | MF | 31249611 | A-31-249611 |
| MF | 236958M1 | A-236958M1 | MF | 31255348 | A-31-255348 |
| MF | 236959M1 | A-236959M1 | MF | 3172001M1 | A-3172001M1 |
| MF | 238859M1 | A-238859M1 | MF | 3175109 | A-3175109 |
| MF | 238891M1 | A-238891M1 | MF | 3180838M1 | A-3180838M1 |
| MF | 240807M1 | A-240807M1 | MF | 3180869M1 | A-3180869M1 |
| MF | 244952M1 | A-244952M1 | MF | 320623M1 | A-320623M1 |
| MF | 252164M1 | A-252164M1 | MF | 3226971M1 | A-3226971M1 |
| MF | 252828950 | A-252828950 | MF | 3287277M1 | A-3287277M1 |
| MF | 252828950M1 | A-252828950M1 | MF | 3288911 | A-3288911 |
| MF | 2543650M1 | A-2543650M1 | MF | 3288999V | A-3288999V |
| MF | 2543650W1 | A-2543650W1 | MF | 3289213 | A-3289213 |
| MF | 2612074 | A-2612074 | MF | 33143A | A-33143A |



MASSEY FERGUSON (MF)

| OEM | OEM  Part No. | PIX  Part No. | OEM | OEM  Part No. | PIX  Part No. |
|-----|--|--|-----|--|--|
| MF | 3315232 | A-3315232 | MF | 619317 | A-619317 |
| MF | 3315232M1 | A-3315232M1 | MF | 619317M1 | A-619317M1 |
| MF | 3439022M1 | A-3439022M1 | MF | 621262 | A-621262 |
| MF | 35615000 | A-35615000 | MF | 621320M1 | A-621320M1 |
| MF | 3568 | A-3568 | MF | 621321 | A-621321 |
| MF | 3616512M91 | A-3616512M91 | MF | 621321M1 | A-621321M1 |
| MF | 3617184M91 | A-3617184M91 | MF | 621588M1 | A-621588M1 |
| MF | 3637978M91 | A-3637978M91 | MF | 621646 | A-621646 |
| MF | 3640790M1 | A-3640790M1 | MF | 621646A | A-621646A |
| MF | 3669118M1 | A-3669118M1 | MF | 675576M1 | A-675576M1 |
| MF | 401109M1 | A-401109M1 | MF | 676135M1 | A-676135M1 |
| MF | 402607 | A-402607 | MF | 703321M1 | A-703321M1 |
| MF | 402608M1 | A-402608M1 | MF | 71188635 | A-71188635 |
| MF | 406888M1 | A-406888M1 | MF | 71322418 | A-71322418 |
| MF | 417441M1 | A-417441M1 | MF | 71396569 | A-71396569 |
| MF | 417441-M1 | A-417441-M1 | MF | 766861M1 | A-766861M1 |
| MF | 417995M1 | A-417995M1 | MF | 782523M1 | A-782523M1 |
| MF | 418192 | A-418192 | MF | 783539 | A-783539 |
| MF | 4273269M1 | A-4273269M1 | MF | 783539-M1 | A-783539-M1 |
| MF | 4275919M1 | A-4275919M1 | MF | 783907M2 | A-783907M2 |
| MF | 4286263M1 | A-4286263M1 | MF | 784170 | A-784170 |
| MF | 4288688M1 | A-4288688M1 | MF | 784170M1 | A-784170M1 |
| MF | 514891M1 | A-514891M1 | MF | 784170M2 | A-784170M2 |
| MF | 521398M91 | A-521398M91 | MF | 784796 | A-784796 |
| MF | 541190M1 | A-541190M1 | MF | 785585 | A-785585 |
| MF | 541390M1 | A-541390M1 | MF | 785585M1 | A-785585M1 |
| MF | 542304M1 | A-542304M1 | MF | 785806M2 | A-785806M2 |
| MF | 542551M1 | A-542551M1 | MF | 788317M1 | A-788317M1 |
| MF | 545000M1 | A-545000M1 | MF | 790833M1 | A-790833M1 |
| MF | 545644M1 | A-545644M1 | MF | 794129M1 | A-794129M1 |
| MF | 545650 | A-545650 | MF | 795514 | A-795514 |
| MF | 545651M1 | A-545651M1 | MF | 795582M1 | A-795582M1 |
| MF | 545652M1 | A-545652M1 | MF | 796487M1 | A-796487M1 |
| MF | 545654M1 | A-545654M1 | MF | 832446M1 | A-832446M1 |
| MF | 550321M1 | A-550321M1 | MF | 832789 | A-832789 |
| MF | 550596M1 | A-550596M1 | MF | 832789M1 | A-832789M1 |
| MF | 551251M1 | A-551251M1 | MF | 832789M2 | A-832789M2 |
| MF | 556779M91 | A-556779M91 | MF | 832790 | A-832790 |
| MF | 557292M1 | A-557292M1 | MF | 832790M1 | A-832790M1 |
| MF | 557514M1 | A-557514M1 | MF | 832822M1 | A-832822M1 |
| MF | 557514M2 | A-557514M2 | MF | 832855M1 | A-832855M1 |
| MF | 557784M1 | A-557784M1 | MF | 832866M1 | A-832866M1 |
| MF | 559808M1 | A-559808M1 | MF | 832869M1 | A-832869M1 |
| MF | 560667M1 | A-560667M1 | MF | 832870M1 | A-832870M1 |
| MF | 561800M1 | A-561800M1 | MF | 832872M1 | A-832872M1 |
| MF | 566844M91 | A-566844M91 | MF | 832876M1 | A-832876M1 |
| MF | 619212M1 | A-619212M1 | MF | 832895M2 | A-832895M2 |

MASSEY FERGUSON (MF)



| OEM | OEM  Part No. | PIX  Part No. | OEM | OEM  Part No. | PIX  Part No. |
|-----|--|--|-----|--|--|
| MF | 832896M1 | A-832896M1 | MF | 905921 | A-905921 |
| MF | 833061M1 | A-833061M1 | MF | 905921A | A-905921A |
| MF | 833127M1 | A-833127M1 | MF | 912717M1 | A-912717M1 |
| MF | 833128M1 | A-833128M1 | MF | 923639M1 | A-923639M1 |
| MF | 833130M1 | A-833130M1 | MF | 923640M1 | A-923640M1 |
| MF | 833131M1 | A-833131M1 | MF | 923802M2 | A-923802M2 |
| MF | 833137M1 | A-833137M1 | MF | 923971M2 | A-923971M2 |
| MF | 833563M1 | A-833563M1 | MF | 924327M1 | A-924327M1 |
| MF | 833655M2 | A-833655M2 | MF | 924329M1 | A-924329M1 |
| MF | 833665M1 | A-833665M1 | MF | 924623M1 | A-924623M1 |
| MF | 833742M1 | A-833742M1 | MF | 924698M1 | A-924698M1 |
| MF | 833854 | A-833854 | MF | 924698M2 | A-924698M2 |
| MF | 833857 | A-833857 | MF | 924769M2 | A-924769M2 |
| MF | 833858 | A-833858 | MF | 925216M1 | A-925216M1 |
| MF | 833859 | A-833859 | MF | 926755M1 | A-926755M1 |
| MF | 833862 | A-833862 | MF | 926781M1 | A-926781M1 |
| MF | 833862M1 | A-833862M1 | MF | 926838M1 | A-926838M1 |
| MF | 833863 | A-833863 | MF | 926838M2 | A-926838M2 |
| MF | 833865 | A-833865 | MF | 927210M1 | A-927210M1 |
| MF | 833866 | A-833866 | MF | 927739M1 | A-927739M1 |
| MF | 833868A | A-833868A | MF | 933139M1 | A-933139M1 |
| MF | 833868M1 | A-833868M1 | MF | 933245M1 | A-933245M1 |
| MF | 833871 | A-833871 | MF | 933505M1 | A-933505M1 |
| MF | 833873 | A-833873 | MF | 947580M1 | A-947580M1 |
| MF | 833874 | A-833874 | MF | 947581M1 | A-947581M1 |
| MF | 833875M1 | A-833875M1 | MF | D41904200 | A-D41904200 |
| MF | 834032M1 | A-834032M1 | MF | D41909000 | A-D41909000 |
| MF | 834057M1 | A-834057M1 | MF | D41911000 | A-D41911000 |
| MF | 834060M1 | A-834060M1 | MF | D41912400 | A-D41912400 |
| MF | 834063M1 | A-834063M1 | MF | D41916800 | A-D41916800 |
| MF | 834110 | A-834110 | MF | D41928100 | A-D41928100 |
| MF | 834110-M1 | A-834110-M1 | MF | D41929000 | A-D41929000 |
| MF | 834148M1 | A-834148M1 | MF | D41930200 | A-D41930200 |
| MF | 834174 | A-834174 | MF | D41933700 | A-D41933700 |
| MF | 834265M1 | A-834265M1 | MF | D41936200 | A-D41936200 |
| MF | 842413 | A-842413 | MF | D41936700 | A-D41936700 |
| MF | 842419M1 | A-842419M1 | MF | D41936800 | A-D41936800 |
| MF | 842851M1 | A-842851M1 | MF | D41937800 | A-D41937800 |
| MF | 843009M1 | A-843009M1 | MF | D41942100 | A-D41942100 |
| MF | 843310 | A-843310 | MF | D41942200 | A-D41942200 |
| MF | 843313 | A-843313 | MF | D41943600 | A-D41943600 |
| MF | 843313M1 | A-843313M1 | MF | D41950100 | A-D41950100 |
| MF | 843732 | A-843732 | MF | D41950400 | A-D41950400 |
| MF | 843732M1 | A-843732M1 | MF | D41963900 | A-D41963900 |
| MF | 843747 | A-843747 | MF | D41979000 | A-D41979000 |
| MF | 844461M1 | A-844461M1 | MF | D41979200 | A-D41979200 |
| MF | 905920 | A-905920 | MF | D41979400 | A-D41979400 |

MASSEY FERGUSON (MF)

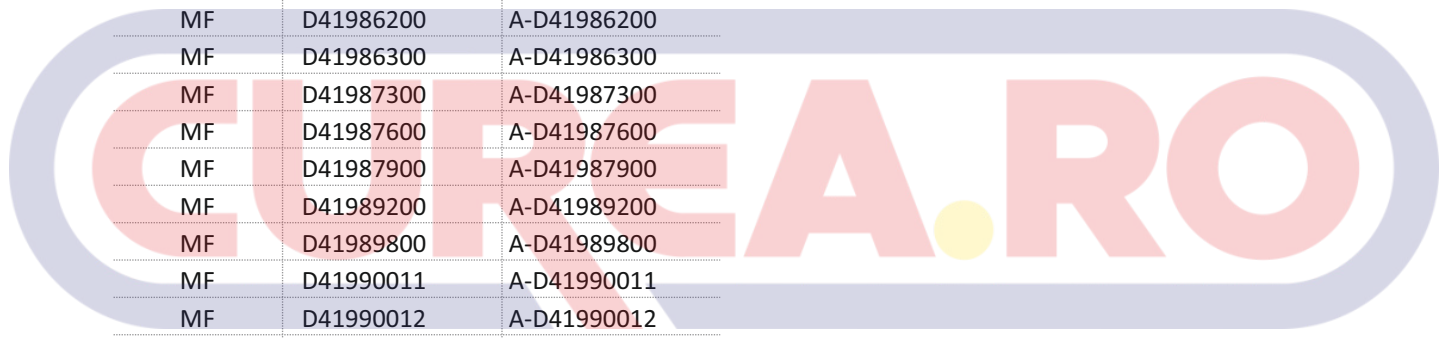

| OEM | OEM  Part No. | PIX  Part No. | OEM | OEM  Part No. | PIX  Part No. |
|-----|--|--|-----|--|--|
| MF | D41979600 | A-D41979600 | MF | V684120900 | A-V684120900 |
| MF | D41980400 | A-D41980400 | MF | V684121475 | A-V684121475 |
| MF | D41980500 | A-D41980500 | MF | V685121570 | A-V685121570 |
| MF | D41981300 | A-D41981300 | MF | V685121880 | A-V685121880 |
| MF | D41981400 | A-D41981400 | MF | V836859262 | A-V836859262 |
| MF | D41981500 | A-D41981500 | | | |
| MF | D41982000 | A-D41982000 | | | |
| MF | D41982100 | A-D41982100 | | | |
| MF | D41982300 | A-D41982300 | | | |
| MF | D41982400 | A-D41982400 | | | |
| MF | D41982600 | A-D41982600 | | | |
| MF | D41983300 | A-D41983300 | | | |
| MF | D41983500 | A-D41983500 | | | |
| MF | D41983600 | A-D41983600 | | | |
| MF | D41984100 | A-D41984100 | | | |
| MF | D41985300 | A-D41985300 | | | |
| MF | D41985900 | A-D41985900 | | | |
| MF | D41986100 | A-D41986100 | | | |
| MF | D41986200 | A-D41986200 | | | |
| MF | D41986300 | A-D41986300 | | | |
| MF | D41987300 | A-D41987300 | | | |
| MF | D41987600 | A-D41987600 | | | |
| MF | D41987900 | A-D41987900 | | | |
| MF | D41989200 | A-D41989200 | | | |
| MF | D41989800 | A-D41989800 | | | |
| MF | D41990011 | A-D41990011 | | | |
| MF | D41990012 | A-D41990012 | | | |
| MF | D41990013 | A-D41990013 | | | |
| MF | D41990048 | A-D41990048 | | | |
| MF | D41990050 | A-D41990050 | | | |
| MF | D41990054 | A-D41990054 | | | |
| MF | D41990056 | A-D41990056 | | | |
| MF | D41990061 | A-D41990061 | | | |
| MF | D41990064 | A-D41990064 | | | |
| MF | D41990068 | A-D41990068 | | | |
| MF | D41990100 | A-D41990100 | | | |
| MF | D41990200 | A-D41990200 | | | |
| MF | D41990400 | A-D41990400 | | | |
| MF | D41990700 | A-D41990700 | | | |
| MF | D41991000 | A-D41991000 | | | |
| MF | D41991300 | A-D41991300 | | | |
| MF | D41991700 | A-D41991700 | | | |
| MF | Gb5314 | A-GB5314 | | | |
| MF | Gh5045 | A-GH5045 | | | |
| MF | Gh5046 | A-GH5046 | | | |
| MF | Gk5105 | A-GK5105 | | | |
| MF | Tx52186 | A-TX52186 | | | |







MENGELE

| OEM | OEM  Part No. | PIX  Part No. |
|---------|--|--|
| MENGELE | 98036276 | A-98036276 |
| MENGELE | 98029383 | A-98029383 |
| MENGELE | 98029384 | A-98029384 |
| MENGELE | 98018167 | A-98018167 |
| MENGELE | 98025521 | A-98025521 |
| MENGELE | 98021123 | A-98021123 |
| MENGELE | 98022200 | A-98022200 |
| MENGELE | 98022731 | A-98022731 |
| MENGELE | 98042619 | A-98042619 |
| MENGELE | 98014367 | A-98014367 |
| MENGELE | 98026937 | A-98026937 |
| MENGELE | 98042380 | A-98042380 |
| MENGELE | 98042202 | A-98042202 |
| MENGELE | 98006272 | A-98006272 |
| MENGELE | 98028271 | A-98028271 |
| MENGELE | 98020849 | A-98020849 |
| MENGELE | 98011048 | A-98011048 |
| MENGELE | 98028266 | A-98028266 |
| MENGELE | 98028267 | A-98028267 |
| MENGELE | 98028268 | A-98028268 |
| MENGELE | 98022265 | A-98022265 |
| MENGELE | 98017686 | A-98017686 |
| MENGELE | 98028264 | A-98028264 |
| MENGELE | 98041414 | A-98041414 |
| MENGELE | 98023422 | A-98023422 |
| MENGELE | 98031590 | A-98031590 |
| MENGELE | 98031801 | A-98031801 |
| MENGELE | 98042442 | A-98042442 |
| MENGELE | 98039955 | A-98039955 |
| MENGELE | 98036045 | A-98036045 |
| MENGELE | 98041779 | A-98041779 |
| MENGELE | 98031803 | A-98031803 |
| MENGELE | 98043776 | A-98043776 |
| MENGELE | 98043777 | A-98043777 |
| MENGELE | 98043775 | A-98043775 |
| MENGELE | 98041435 | A-98041435 |
| MENGELE | 98028534 | A-98028534 |
| MENGELE | 98042197 | A-98042197 |
| MENGELE | 98031800 | A-98031800 |
| MENGELE | 98045896 | A-98045896 |





PÖTTINGER

| OEM | OEM  Part No. | PIX  Part No. |
|-----------|--|--|
| PÖTTINGER | 460216 | A-460216 |
| PÖTTINGER | 460217 | A-460217 |
| PÖTTINGER | 460218 | A-460218 |
| PÖTTINGER | 460195 | A-460195 |
| PÖTTINGER | 460194 | A-460194 |
| PÖTTINGER | 460222 | A-460222 |
| PÖTTINGER | 460197 | A-460197 |
| PÖTTINGER | 460196 | A-460196 |
| PÖTTINGER | 460223 | A-460223 |
| PÖTTINGER | 460212 | A-460212 |
| PÖTTINGER | 460411 | A-460411 |
| PÖTTINGER | 460412 | A-460412 |
| PÖTTINGER | 460013 | A-460013 |
| PÖTTINGER | 460413 | A-460413 |
| PÖTTINGER | 460231 | A-460231 |
| PÖTTINGER | 460201 | A-460201 |
| PÖTTINGER | 460253 | A-460253 |
| PÖTTINGER | 460452 | A-460452 |
| PÖTTINGER | 460047 | A-460047 |
| PÖTTINGER | 460057 | A-460057 |
| PÖTTINGER | 460062 | A-460062 |
| PÖTTINGER | 460061 | A-460061 |
| PÖTTINGER | 460066 | A-460066 |
| PÖTTINGER | 460063 | A-460063 |
| PÖTTINGER | 460186 | A-460186 |
| PÖTTINGER | 460184 | A-460184 |
| PÖTTINGER | 460188 | A-460188 |
| PÖTTINGER | 460189 | A-460189 |
| PÖTTINGER | 460198 | A-460198 |
| PÖTTINGER | 460192 | A-460192 |
| PÖTTINGER | 460199 | A-460199 |
| PÖTTINGER | 460409 | A-460409 |
| PÖTTINGER | 460259 | A-460259 |
| PÖTTINGER | 460420 | A-460420 |
| PÖTTINGER | 460048 | A-460048 |
| PÖTTINGER | 460056 | A-460056 |
| PÖTTINGER | 460408 | A-460408 |
| PÖTTINGER | 460453 | A-460453 |
| PÖTTINGER | 460055 | A-460055 |
| PÖTTINGER | 460000025 | A-460000025 |
| PÖTTINGER | 460000026 | A-460000026 |





ROSTSELMASH

| OEM | OEM  Part No. | PIX  Part No. | OEM | OEM  Part No. | PIX  Part No. |
|-------------|--|--|-------------|--|--|
| ROSTSELMASH | 6201381 | A-6201381 | ROSTSELMASH | 6201418 | A-6201418 |
| ROSTSELMASH | 6201406 | A-6201406 | ROSTSELMASH | 6201416 | A-6201416 |
| ROSTSELMASH | 6201417 | A-6201417 | ROSTSELMASH | 6201422 | A-6201422 |
| ROSTSELMASH | 6201401 | A-6201401 | ROSTSELMASH | 6201081 | A-6201081 |
| ROSTSELMASH | 6201005 | A-6201005 | ROSTSELMASH | 6201414 | A-6201414 |
| ROSTSELMASH | 6201405 | A-6201405 | ROSTSELMASH | 6201387 | A-6201387 |
| ROSTSELMASH | 6201412 | A-6201412 | ROSTSELMASH | 6201324 | A-6201324 |
| ROSTSELMASH | 6201097 | A-6201097 | ROSTSELMASH | 6201396 | A-6201396 |
| ROSTSELMASH | 6201315 | A-6201315 | ROSTSELMASH | 6201421 | A-6201421 |
| ROSTSELMASH | 6201356 | A-6201356 | ROSTSELMASH | 6201339 | A-6201339 |
| ROSTSELMASH | 6201357 | A-6201357 | ROSTSELMASH | 6201087 | A-6201087 |
| ROSTSELMASH | 6201349 | A-6201349 | ROSTSELMASH | 6201091 | A-6201091 |
| ROSTSELMASH | 6201358 | A-6201358 | ROSTSELMASH | 6201277 | A-6201277 |
| ROSTSELMASH | 6201022 | A-6201022 | ROSTSELMASH | 6201298 | A-6201298 |
| ROSTSELMASH | 6201342 | A-6201342 | ROSTSELMASH | 6201080 | A-6201080 |
| ROSTSELMASH | 6201023 | A-6201023 | ROSTSELMASH | 6201411 | A-6201411 |
| ROSTSELMASH | 6201350 | A-6201350 | ROSTSELMASH | 6201432 | A-6201432 |
| ROSTSELMASH | 6201006 | A-6201006 | ROSTSELMASH | 6201393 | A-6201393 |
| ROSTSELMASH | 6201382 | A-6201382 | ROSTSELMASH | 6201426 | A-6201426 |
| ROSTSELMASH | 6201397 | A-6201397 | ROSTSELMASH | 6201380 | A-6201380 |
| ROSTSELMASH | 6201383 | A-6201383 | ROSTSELMASH | 6201379 | A-6201379 |
| ROSTSELMASH | 6201419 | A-6201419 | ROSTSELMASH | 6201384 | A-6201384 |
| ROSTSELMASH | 6201363 | A-6201363 | ROSTSELMASH | 6201403 | A-6201403 |
| ROSTSELMASH | 6201317 | A-6201317 | ROSTSELMASH | 6201461 | A-6201461 |
| ROSTSELMASH | 6201330 | A-6201330 | ROSTSELMASH | 6201437 | A-6201437 |
| ROSTSELMASH | 6201084 | A-6201084 | ROSTSELMASH | 6201428 | A-6201428 |
| ROSTSELMASH | 6201404 | A-6201404 | ROSTSELMASH | 6201485 | A-6201485 |
| ROSTSELMASH | 6201424 | A-6201424 | ROSTSELMASH | 6201493 | A-6201493 |
| ROSTSELMASH | 6201392 | A-6201392 | ROSTSELMASH | 6201506 | A-6201506 |
| ROSTSELMASH | 6201029 | A-6201029 | ROSTSELMASH | 6201517 | A-6201517 |
| ROSTSELMASH | 6201400 | A-6201400 | ROSTSELMASH | 6201519 | A-6201519 |
| ROSTSELMASH | 6201089 | A-6201089 | ROSTSELMASH | 6201521 | A-6201521 |
| ROSTSELMASH | 6201420 | A-6201420 | ROSTSELMASH | 6201522 | A-6201522 |
| ROSTSELMASH | 6201318 | A-6201318 | ROSTSELMASH | 6201523 | A-6201523 |
| ROSTSELMASH | 6201088 | A-6201088 | ROSTSELMASH | 6201524 | A-6201524 |
| ROSTSELMASH | 6201340 | A-6201340 | ROSTSELMASH | 6201525 | A-6201525 |
| ROSTSELMASH | 6201096 | A-6201096 | ROSTSELMASH | 6201526 | A-6201526 |
| ROSTSELMASH | 6201373 | A-6201373 | ROSTSELMASH | 6201527 | A-6201527 |
| ROSTSELMASH | 6201415 | A-6201415 | ROSTSELMASH | 6201528 | A-6201528 |
| ROSTSELMASH | 6201086 | A-6201086 | ROSTSELMASH | 6201529 | A-6201529 |
| ROSTSELMASH | 6201265 | A-6201265 | ROSTSELMASH | 6201536 | A-6201536 |
| ROSTSELMASH | 6201319 | A-6201319 | ROSTSELMASH | 6201541 | A-6201541 |
| ROSTSELMASH | 6201335 | A-6201335 | ROSTSELMASH | 6201547 | A-6201547 |
| ROSTSELMASH | 6201399 | A-6201399 | ROSTSELMASH | 6201548 | A-6201548 |
| ROSTSELMASH | 6201329 | A-6201329 | ROSTSELMASH | 6201551 | A-6201551 |
| ROSTSELMASH | 6201341 | A-6201341 | ROSTSELMASH | 6201575 | A-6201575 |
| ROSTSELMASH | 6201394 | A-6201394 | ROSTSELMASH | 6201582 | A-6201582 |
| ROSTSELMASH | 6201413 | A-6201413 | ROSTSELMASH | 6201587 | A-6201587 |
| ROSTSELMASH | 6201195 | A-6201195 | ROSTSELMASH | 6201592 | A-6201592 |
| ROSTSELMASH | 6201408 | A-6201408 | | | |
| ROSTSELMASH | 6201196 | A-6201196 | | | |
| ROSTSELMASH | 6201085 | A-6201085 | | | |
| ROSTSELMASH | 6201322 | A-6201322 | | | |
| ROSTSELMASH | 6201320 | A-6201320 | | | |
| ROSTSELMASH | 6201083 | A-6201083 | | | |





SAME-DEUTZ-FAHR (SDF)

| OEM | OEM  Part No. | PIX  Part No. | OEM | OEM  Part No. | PIX  Part No. |
|-----|--|--|-----|--|--|
| SDF | 6215221 | A-6215221 | SDF | 6212900 | A-6212900 |
| SDF | 1145790 | A-1145790 | SDF | 1145959 | A-1145959 |
| SDF | 1181126 | A-1181126 | SDF | 1145625 | A-1145625 |
| SDF | 1145504 | A-1145504 | SDF | 1116094 | A-1116094 |
| SDF | 2235056 | A-2235056 | SDF | 1141788 | A-1141788 |
| SDF | 6528420 | A-6528420 | SDF | 1145940 | A-1145940 |
| SDF | 6215249 | A-6215249 | SDF | 6210894 | A-6210894 |
| SDF | 6215235 | A-6215235 | SDF | 1145977 | A-1145977 |
| SDF | 6255583 | A-6255583 | SDF | 1145782 | A-1145782 |
| SDF | 6212918 | A-6212918 | SDF | 1145725 | A-1145725 |
| SDF | 6241147 | A-6241147 | SDF | 1116095 | A-1116095 |
| SDF | 6211026 | A-6211026 | SDF | 1145685 | A-1145685 |
| SDF | 6211031 | A-6211031 | SDF | 1145631 | A-1145631 |
| SDF | 6215215 | A-6215215 | SDF | 1116096 | A-1116096 |
| SDF | 2235256 | A-2235256 | SDF | 1145973 | A-1145973 |
| SDF | 4342249 | A-4342249 | SDF | 1100903 | A-1100903 |
| SDF | 4325382 | A-4325382 | SDF | 6256381 | A-6256381 |
| SDF | 1397776 | A-1397776 | SDF | 1145214 | A-1145214 |
| SDF | 6212834 | A-6212834 | SDF | 6210904 | A-6210904 |
| SDF | 6228207 | A-6228207 | SDF | 6256547 | A-6256547 |
| SDF | 6580119 | A-6580119 | SDF | 6210906 | A-6210906 |
| SDF | 6580049 | A-6580049 | SDF | 1145215 | A-1145215 |
| SDF | 6212833 | A-6212833 | SDF | 6210912 | A-6210912 |
| SDF | 1168304 | A-1168304 | SDF | 1145989 | A-1145989 |
| SDF | 1160990 | A-1160990 | SDF | 6210913 | A-6210913 |
| SDF | 1163087 | A-1163087 | SDF | 1116097 | A-1116097 |
| SDF | 1145921 | A-1145921 | SDF | 6210915 | A-6210915 |
| SDF | 1145970 | A-1145970 | SDF | 6210916 | A-6210916 |
| SDF | 1162717 | A-1162717 | SDF | 6210918 | A-6210918 |
| SDF | 6204283 | A-6204283 | SDF | 1145003 | A-1145003 |
| SDF | 1116063 | A-1116063 | SDF | 6210919 | A-6210919 |
| SDF | 6210869 | A-6210869 | SDF | 1145216 | A-1145216 |
| SDF | 6210870 | A-6210870 | SDF | 1141840 | A-1141840 |
| SDF | 1145367 | A-1145367 | SDF | 6210921 | A-6210921 |
| SDF | 1116060 | A-1116060 | SDF | 1141765 | A-1141765 |
| SDF | 1116062 | A-1116062 | SDF | 6210924 | A-6210924 |
| SDF | 1116080 | A-1116080 | SDF | 6210925 | A-6210925 |
| SDF | 6210880 | A-6210880 | SDF | 1145697 | A-1145697 |
| SDF | 6210881 | A-6210881 | SDF | 1143497 | A-1143497 |
| SDF | 1116089 | A-1116089 | SDF | 1141850 | A-1141850 |
| SDF | 1116091 | A-1116091 | SDF | 6210853 | A-6210853 |
| SDF | 1397850 | A-1397850 | SDF | 1145263 | A-1145263 |
| SDF | 1116092 | A-1116092 | SDF | 1145218 | A-1145218 |
| SDF | 1145960 | A-1145960 | SDF | 6210929 | A-6210929 |
| SDF | 6210889 | A-6210889 | SDF | 6210930 | A-6210930 |
| SDF | 1145047 | A-1145047 | SDF | 6210874 | A-6210874 |
| SDF | 1116093 | A-1116093 | SDF | 6204315 | A-6204315 |





SAME-DEUTZ-FAHR (SDF)

| OEM | OEM  Part No. | PIX  Part No. | OEM | OEM  Part No. | PIX  Part No. |
|-----|--|--|-----|--|--|
| SDF | 6204317 | A-6204317 | SDF | 1397596 | A-1397596 |
| SDF | 6204318 | A-6204318 | SDF | 6210973 | A-6210973 |
| SDF | 6204325 | A-6204325 | SDF | 6210977 | A-6210977 |
| SDF | 6204326 | A-6204326 | SDF | 6210978 | A-6210978 |
| SDF | 6204327 | A-6204327 | SDF | 1139079 | A-1139079 |
| SDF | 6204329 | A-6204329 | SDF | 1116131 | A-1116131 |
| SDF | 6212909 | A-6212909 | SDF | 6210981 | A-6210981 |
| SDF | 6212919 | A-6212919 | SDF | 1141938 | A-1141938 |
| SDF | 6242124 | A-6242124 | SDF | 1139080 | A-1139080 |
| SDF | 6254069 | A-6254069 | SDF | 6210984 | A-6210984 |
| SDF | 6254070 | A-6254070 | SDF | 1139081 | A-1139081 |
| SDF | 6204310 | A-6204310 | SDF | 1145738 | A-1145738 |
| SDF | 6214290 | A-6214290 | SDF | 6210986 | A-6210986 |
| SDF | 1116113 | A-1116113 | SDF | 1145449 | A-1145449 |
| SDF | 6210932 | A-6210932 | SDF | 1141770 | A-1141770 |
| SDF | 1116114 | A-1116114 | SDF | 6210988 | A-6210988 |
| SDF | 6210934 | A-6210934 | SDF | 6210989 | A-6210989 |
| SDF | 6210938 | A-6210938 | SDF | 6204291 | A-6204291 |
| SDF | 6210939 | A-6210939 | SDF | 1141882 | A-1141882 |
| SDF | 6210941 | A-6210941 | SDF | 1145203 | A-1145203 |
| SDF | 6210943 | A-6210943 | SDF | 1141917 | A-1141917 |
| SDF | 1139070 | A-1139070 | SDF | 1141622 | A-1141622 |
| SDF | 6210947 | A-6210947 | SDF | 1145143 | A-1145143 |
| SDF | 1139071 | A-1139071 | SDF | 6210992 | A-6210992 |
| SDF | 6204289 | A-6204289 | SDF | 1145505 | A-1145505 |
| SDF | 6210951 | A-6210951 | SDF | 1145462 | A-1145462 |
| SDF | 6210953 | A-6210953 | SDF | 6210994 | A-6210994 |
| SDF | 6210954 | A-6210954 | SDF | 1141373 | A-1141373 |
| SDF | 6210955 | A-6210955 | SDF | 1141958 | A-1141958 |
| SDF | 6210957 | A-6210957 | SDF | 1142150 | A-1142150 |
| SDF | 1139073 | A-1139073 | SDF | 1145461 | A-1145461 |
| SDF | 1139074 | A-1139074 | SDF | 6210996 | A-6210996 |
| SDF | 6210960 | A-6210960 | SDF | 1145884 | A-1145884 |
| SDF | 1139076 | A-1139076 | SDF | 1141758 | A-1141758 |
| SDF | 6210963 | A-6210963 | SDF | 1141626 | A-1141626 |
| SDF | 6204295 | A-6204295 | SDF | 6210997 | A-6210997 |
| SDF | 1139078 | A-1139078 | SDF | 1141894 | A-1141894 |
| SDF | 1141554 | A-1141554 | SDF | 1139082 | A-1139082 |
| SDF | 3210969 | A-3210969 | SDF | 6210999 | A-6210999 |
| SDF | 6210969 | A-6210969 | SDF | 1141643 | A-1141643 |
| SDF | 1139252 | A-1139252 | SDF | 1139083 | A-1139083 |
| SDF | 1179132 | A-1179132 | SDF | 6211001 | A-6211001 |
| SDF | 1339252 | A-1339252 | SDF | 1139084 | A-1139084 |
| SDF | 6210970 | A-6210970 | SDF | 6211003 | A-6211003 |
| SDF | 6210971 | A-6210971 | SDF | 1145186 | A-1145186 |
| SDF | 1145990 | A-1145990 | SDF | 6211004 | A-6211004 |
| SDF | 1145699 | A-1145699 | SDF | 1145792 | A-1145792 |





SAME-DEUTZ-FAHR (SDF)

| OEM | OEM  Part No. | PIX  Part No. | OEM | OEM  Part No. | PIX  Part No. |
|-----|--|--|-----|--|--|
| SDF | 1141823 | A-1141823 | SDF | 6204296 | A-6204296 |
| SDF | 1145949 | A-1145949 | SDF | 6204297 | A-6204297 |
| SDF | 1139301 | A-1139301 | SDF | 4453084 | A-4453084 |
| SDF | 1145481 | A-1145481 | SDF | 1180447 | A-1180447 |
| SDF | 6211006 | A-6211006 | SDF | 1180448 | A-1180448 |
| SDF | 1139085 | A-1139085 | SDF | 1180450 | A-1180450 |
| SDF | 1141798 | A-1141798 | SDF | 1181260 | A-1181260 |
| SDF | 1139086 | A-1139086 | SDF | 4437549 | A-4437549 |
| SDF | 1145633 | A-1145633 | SDF | 1145937 | A-1145937 |
| SDF | 6273237 | A-6273237 | SDF | 1145262 | A-1145262 |
| SDF | 1141644 | A-1141644 | SDF | 16031538 | A-16031538 |
| SDF | 1231688 | A-1231688 | SDF | 1145260 | A-1145260 |
| SDF | 6211009 | A-6211009 | SDF | 16015922 | A-16015922 |
| SDF | 1231696 | A-1231696 | SDF | 1145667 | A-1145667 |
| SDF | 6211010 | A-6211010 | SDF | 6204334 | A-6204334 |
| SDF | 1231697 | A-1231697 | SDF | 1141816 | A-1141816 |
| SDF | 1145335 | A-1145335 | SDF | 6215231 | A-6215231 |
| SDF | 6257897 | A-6257897 | SDF | 1141819 | A-1141819 |
| SDF | 1145922 | A-1145922 | SDF | 1141918 | A-1141918 |
| SDF | 1139088 | A-1139088 | SDF | 1145226 | A-1145226 |
| SDF | 6204304 | A-6204304 | SDF | 6215236 | A-6215236 |
| SDF | 6211016 | A-6211016 | SDF | 6215242 | A-6215242 |
| SDF | 1104054 | A-1104054 | SDF | 6215241 | A-6215241 |
| SDF | 6211019 | A-6211019 | SDF | 6215234 | A-6215234 |
| SDF | 6211020 | A-6211020 | SDF | 1141503 | A-1141503 |
| SDF | 6211023 | A-6211023 | SDF | 1141624 | A-1141624 |
| SDF | 6211053 | A-6211053 | SDF | 1141625 | A-1141625 |
| SDF | 6211024 | A-6211024 | SDF | 1141502 | A-1141502 |
| SDF | 6211025 | A-6211025 | SDF | 1145632 | A-1145632 |
| SDF | 6211027 | A-6211027 | SDF | 1145750 | A-1145750 |
| SDF | 1139089 | A-1139089 | SDF | 6215195 | A-6215195 |
| SDF | 6204322 | A-6204322 | SDF | 1145724 | A-1145724 |
| SDF | 6211032 | A-6211032 | SDF | 1141762 | A-1141762 |
| SDF | 6211033 | A-6211033 | SDF | 6215206 | A-6215206 |
| SDF | 6211034 | A-6211034 | SDF | 1145590 | A-1145590 |
| SDF | 1139090 | A-1139090 | SDF | 1141792 | A-01141792 |
| SDF | 1139091 | A-1139091 | SDF | 1145457 | A-1145457 |
| SDF | 1139092 | A-1139092 | SDF | 1145261 | A-1145261 |
| SDF | 6211041 | A-6211041 | SDF | 1141912 | A-1141912 |
| SDF | 6211042 | A-6211042 | SDF | 1145458 | A-1145458 |
| SDF | 6211043 | A-6211043 | SDF | 1174974 | A-1174974 |
| SDF | 1139093 | A-1139093 | SDF | 1141909 | A-1141909 |
| SDF | 6211046 | A-6211046 | SDF | 1145690 | A-1145690 |
| SDF | 6204335 | A-6204335 | SDF | 1145866 | A-1145866 |
| SDF | 6204333 | A-6204333 | SDF | 1145751 | A-1145751 |
| SDF | 6204332 | A-6204332 | SDF | 6204307 | A-6204307 |
| SDF | 6215219 | A-6215219 | SDF | 6204311 | A-6204311 |





SAME-DEUTZ-FAHR (SDF)

| OEM | OEM  Part No. | PIX  Part No. | OEM | OEM  Part No. | PIX  Part No. |
|-----|--|--|-----|--|--|
| SDF | 16015923 | A-16015923 | SDF | 2235421 | A-2235421 |
| SDF | 1145459 | A-1145459 | SDF | 1182429 | A-1182429 |
| SDF | 1145865 | A-1145865 | SDF | 1182429 | A-1182429 |
| SDF | 1145660 | A-1145660 | SDF | 4435634 | A-4435634 |
| SDF | 1145689 | A-1145689 | SDF | 1145668 | A-1145668 |
| SDF | 4452089 | A-4452089 | SDF | 1154357 | A-1154357 |
| SDF | 4452089 | A-4452089 | SDF | 1168325 | A-1168325 |
| SDF | 4454180 | A-04454180 | SDF | 1175765 | A-1175765 |
| SDF | 6215212 | A-6215212 | SDF | 1176330 | A-1176330 |
| SDF | 6215226 | A-6215226 | SDF | 1180516 | A-1180516 |
| SDF | 16042133 | A-16042133 | SDF | 1180517 | A-1180517 |
| SDF | 16031403 | A-16031403 | SDF | 1180848 | A-1180848 |
| SDF | 1145680 | A-1145680 | SDF | 1181185 | A-1181185 |
| SDF | 1145742 | A-1145742 | SDF | 2419104 | A-2419104 |
| SDF | 1145744 | A-1145744 | SDF | 4305745 | A-4305745 |
| SDF | 1145628 | A-1145628 | SDF | 4325871 | A-4325871 |
| SDF | 4455253 | A-4455253 | SDF | 4343181 | A-4343181 |
| SDF | 2235531 | A-02235531 | SDF | 4359336 | A-4359336 |
| SDF | 1139214 | A-1139214 | SDF | 4437559 | A-4437559 |
| SDF | 1139215 | A-1139215 | SDF | 4437560 | A-4437560 |
| SDF | 1139216 | A-1139216 | SDF | 4438414 | A-4438414 |
| SDF | 1139217 | A-1139217 | SDF | 4450657 | A-4450657 |
| SDF | 1139218 | A-1139218 | SDF | 4452801 | A-4452801 |
| SDF | 1139219 | A-1139219 | SDF | 4455177 | A-4455177 |
| SDF | 1139220 | A-1139220 | SDF | 16029939 | A-16029939 |
| SDF | 1139221 | A-1139221 | SDF | 1175765 | A-1175765 |
| SDF | 1139222 | A-1139222 | SDF | 1180516 | A-1180516 |
| SDF | 1181366 | A-1181366 | SDF | 1180517 | A-1180517 |
| SDF | 2231579 | A-2231579 | SDF | 1181185 | A-1181185 |
| SDF | 2235175 | A-2235175 | SDF | 4325871 | A-4325871 |
| SDF | 2235176 | A-2235176 | SDF | 4359336 | A-4359336 |
| SDF | 2235178 | A-2235178 | SDF | 4438414 | A-4438414 |
| SDF | 2235179 | A-2235179 | SDF | 4455177 | A-4455177 |
| SDF | 2235181 | A-2235181 | SDF | 1180553 | A-1180553 |
| SDF | 2235254 | A-2235254 | SDF | 4452440 | A-4452440 |
| SDF | 2235255 | A-2235255 | SDF | 6212871 | A-6212871 |
| SDF | 2235421 | A-2235421 | SDF | 6212872 | A-6212872 |
| SDF | 2235533 | A-2235533 | SDF | 6204284 | A-6204284 |
| SDF | 2239152 | A-2239152 | SDF | 6212874 | A-6212874 |
| SDF | 6212847 | A-6212847 | SDF | 1139300 | A-1139300 |
| SDF | 6212850 | A-6212850 | SDF | 1139234 | A-1139234 |
| SDF | 6212851 | A-6212851 | SDF | 6204287 | A-6204287 |
| SDF | 6212852 | A-6212852 | SDF | 6298998 | A-6298998 |
| SDF | 2235175 | A-2235175 | SDF | 6204285 | A-6204285 |
| SDF | 2235178 | A-2235178 | SDF | 6204286 | A-6204286 |
| SDF | 2235179 | A-2235179 | SDF | 6204288 | A-6204288 |
| SDF | 2235181 | A-2235181 | SDF | 6212883 | A-6212883 |





SAME-DEUTZ-FAHR (SDF)

| OEM | OEM  Part No. | PIX  Part No. | OEM | OEM  Part No. | PIX  Part No. |
|-----|--|--|-----|--|--|
| SDF | 6212885 | A-6212885 | SDF | 1145802 | A-1145802 |
| SDF | 1139235 | A-1139235 | SDF | 16617104 | A-16617104 |
| SDF | 1139237 | A-1139237 | SDF | 1142840 | A-1142840 |
| SDF | 6212890 | A-6212890 | SDF | 0.0183111.0 | A-.0183111.0 |
| SDF | 1145823 | A-1145823 | SDF | 2.4119.211.0 | A-2.4119.211.0 |
| SDF | 6212894 | A-6212894 | SDF | 0.018.3550.0 | A-.018.3550.0 |
| SDF | 1141818 | A-1141818 | SDF | 2.4119.204.0 | A-2.4119.204.0 |
| SDF | 1141801 | A-1141801 | SDF | 16062841 | A-16062841 |
| SDF | 1397518 | A-1397518 | SDF | 2.4119.210.0 | A-2.4119.210.0 |
| SDF | 6212895 | A-6212895 | SDF | 2.4119.208.0 | A-2.4119.208.0 |
| SDF | 1139634 | A-1139634 | SDF | 2.4119.207.0 | A-2.4119.207.0 |
| SDF | 1141642 | A-1141642 | SDF | 0.017.4868.0 | A-.017.4868.0 |
| SDF | 6212896 | A-6212896 | SDF | 0.018.9690.0 | A-.018.9690.0 |
| SDF | 1139207 | A-1139207 | SDF | 16062842 | A-16062842 |
| SDF | 6204331 | A-6204331 | SDF | 16061769 | A-16061769 |
| SDF | 1139240 | A-1139240 | SDF | 36200413 | A-36200413 |
| SDF | 6204314 | A-6204314 | SDF | 3170529 | A-3170529 |
| SDF | 6204324 | A-6204324 | SDF | 33700746 | A-33700746 |
| SDF | 6212907 | A-6212907 | SDF | 3170537 | A-3170537 |
| SDF | 1139253 | A-1139253 | SDF | 3170537 | A-3170537 |
| SDF | 1139254 | A-1139254 | SDF | 4154525 | A-4154525 |
| SDF | 6212925 | A-6212925 | SDF | 9351.0176.00 | A-9351.0176.00 |
| SDF | 6212927 | A-6212927 | SDF | 0.018.9044.0 | A-.018.9044.0 |
| SDF | 6235567 | A-6235567 | SDF | 2.4119.213.0 | A-2.4119.213.0 |
| SDF | 6241910 | A-6241910 | SDF | T040H02 | A-T040H02 |
| SDF | 6301463 | A-6301463 | SDF | 1146033 | A-1146033 |
| SDF | 1139256 | A-1139256 | SDF | 16062885 | A-16062885 |
| SDF | 1139209 | A-1139209 | SDF | 16062737 | A-16062737 |
| SDF | 6212932 | A-6212932 | SDF | 16062737/10 | A-16062737/10 |
| SDF | 6212933 | A-6212933 | SDF | 16062737/30 | A-16062737/30 |
| SDF | 1139210 | A-1139210 | SDF | 16062737/20 | A-16062737/20 |
| SDF | 1141623 | A-1141623 | SDF | 16039033 | A-16039033 |
| SDF | 6212845 | A-6212845 | SDF | 16062738 | A-16062738 |
| SDF | 1139205 | A-1139205 | SDF | 0.017.7465.0 | A-.017.7465.0 |
| SDF | 1139206 | A-1139206 | SDF | 1141820 | A-1141820 |
| SDF | 6212855 | A-6212855 | SDF | 1145064 | A-1145064 |
| SDF | 6212839 | A-6212839 | SDF | 1141888 | A-1141888 |
| SDF | 6212840 | A-6212840 | SDF | 1145224 | A-1145224 |
| SDF | 1139213 | A-1139213 | SDF | 16031404 | A-16031404 |
| SDF | 6212842 | A-6212842 | SDF | 6215207 | A-6215207 |
| SDF | 6212843 | A-6212843 | SDF | 16062883 | A-16062883 |
| SDF | 1141637 | A-1141637 | SDF | 3651575 | A-3651575 |
| SDF | 6273876 | A-6273876 | SDF | 0.018.1907.0 | A-.018.1907.0 |
| SDF | 6215208 | A-6215208 | SDF | 16024474 | A-16024474 |
| SDF | 1141904 | A-1141904 | SDF | 16062265 | A-16062265 |
| SDF | 1145626 | A-1145626 | SDF | 0.018.1930.0 | A-.018.1930.0 |
| SDF | 1145726 | A-1145726 | SDF | 6259006 | A-6259006 |





SAME-DEUTZ-FAHR (SDF)

| OEM | OEM  Part No. | PIX  Part No. | OEM | OEM  Part No. | PIX  Part No. |
|-----|--|--|-----|--|--|
| SDF | 1145334 | A-1145334 | SDF | 1183380 | A-1183380 |
| SDF | 6215211 | A-6215211 | SDF | 1183558 | A-1183558 |
| SDF | 6204313 | A-6204313 | SDF | 1182607 | A-1182607 |
| SDF | 16062735 | A-16062735 | SDF | 1183391 | A-1183391 |
| SDF | 16026321 | A-16026321 | SDF | 1182312 | A-1182312 |
| SDF | 16055471 | A-16055471 | SDF | 1182360 | A-1182360 |
| SDF | 1182599 | A-1182599 | SDF | 1182367 | A-1182367 |
| SDF | 1148874 | A-1148874 | SDF | 1182728 | A-1182728 |
| SDF | 1179988 | A-1179988 | SDF | 1182729 | A-1182729 |
| SDF | 1179565 | A-1179565 | SDF | 1182830 | A-1182830 |
| SDF | 1179565 | A-1179565 | SDF | 1182831 | A-1182831 |
| SDF | 1179564 | A-1179564 | SDF | 1182832 | A-1182832 |
| SDF | 1179564 | A-1179564 | SDF | 1183144 | A-1183144 |
| SDF | 1180173 | A-1180173 | SDF | 1183145 | A-1183145 |
| SDF | 1180173 | A-1180173 | SDF | 1183146 | A-1183146 |
| SDF | 1180833 | A-1180833 | SDF | 1183147 | A-1183147 |
| SDF | 1182499 | A-1182499 | SDF | 1183148 | A-1183148 |
| SDF | 1178461 | A-1178461 | SDF | 1183149 | A-1183149 |
| SDF | 1178461 | A-1178461 | SDF | 1182310 | A-1182310 |
| SDF | 1179777 | A-1179777 | SDF | 1182365 | A-1182365 |
| SDF | 1182339 | A-1182339 | SDF | 1182726 | A-1182726 |
| SDF | 1154352 | A-1154352 | SDF | 1182727 | A-1182727 |
| SDF | 1180468 | A-1180468 | SDF | 1183150 | A-1183150 |
| SDF | 1154352 | A-1154352 | SDF | 1183151 | A-1183151 |
| SDF | 1179088 | A-1179088 | SDF | 1183152 | A-1183152 |
| SDF | 1183205 | A-1183205 | SDF | 1183559 | A-1183559 |
| SDF | 1168314 | A-1168314 | SDF | 1181730 | A-1181730 |
| SDF | 1178737 | A-1178737 | SDF | 1182740 | A-1182740 |
| SDF | 1179479 | A-1179479 | SDF | 1183153 | A-1183153 |
| SDF | 1180619 | A-1180619 | SDF | 1183377 | A-1183377 |
| SDF | 1182063 | A-1182063 | SDF | 1182347 | A-1182347 |
| SDF | 1180172 | A-1180172 | SDF | 1182369 | A-1182369 |
| SDF | 16062763 | A-16062763 | SDF | 1182449 | A-1182449 |
| SDF | 16062884 | A-16062884 | SDF | 1182730 | A-1182730 |
| SDF | 1180150 | A-1180150 | SDF | 1182731 | A-1182731 |
| SDF | 1154311 | A-1154311 | SDF | 1183154 | A-1183154 |
| SDF | 1178685 | A-1178685 | SDF | 1183155 | A-1183155 |
| SDF | 1180847 | A-1180847 | SDF | 1183156 | A-1183156 |
| SDF | 1145693 | A-1145693 | SDF | 1182471 | A-1182471 |
| SDF | 0.017.9350.0 | A-.017.9350.0 | SDF | 1182559 | A-1182559 |
| SDF | 2.4119.203.0 | A-2.4119.203.0 | SDF | 1183164 | A-1183164 |
| SDF | 2.4119.205.0 | A-2.4119.205.0 | SDF | 1182767 | A-1182767 |
| SDF | X221765 | A-X221765 | SDF | 1183165 | A-1183165 |
| SDF | 1181748 | A-1181748 | SDF | 1168311 | A-1168311 |
| SDF | 1182600 | A-1182600 | SDF | 1168313 | A-1168313 |
| SDF | 1183420 | A-1183420 | SDF | 1168316 | A-1168316 |
| SDF | 1181768 | A-1181768 | SDF | 1169889 | A-1169889 |

SAME-DEUTZ-FAHR (SDF)

| OEM | OEM  Part No. | PIX  Part No. | OEM | OEM  Part No. | PIX  Part No. |
|-----|--|--|-----|--|--|
| SDF | 1168318 | A-1168318 | SDF | 1145703 | A-1145703 |
| SDF | 1172391 | A-1172391 | SDF | 1136731 | A-1136731 |
| SDF | 1168322 | A-1168322 | SDF | 1145368 | A-1145368 |
| SDF | 1168328 | A-1168328 | SDF | 6215254 | A-6215254 |
| SDF | 1168330 | A-1168330 | SDF | 1145961 | A-1145961 |
| SDF | 1168334 | A-1168334 | SDF | 1145630 | A-1145630 |
| SDF | 1168333 | A-1168333 | SDF | 6215251 | A-6215251 |
| SDF | 1160050 | A-1160050 | SDF | 19971575 | A-1-99-71575 |
| SDF | 1116064 | A-1116064 | SDF | 1145465 | A-1145465 |
| SDF | 1116059 | A-1116059 | SDF | 19951995 | A-1-99-51995 |
| SDF | 1153065 | A-1153065 | SDF | 1145484 | A-1145484 |
| SDF | 1116061 | A-1116061 | SDF | 1145766 | A-1145766 |
| SDF | 1116078 | A-1116078 | SDF | 1145627 | A-1145627 |
| SDF | 1116087 | A-1116087 | SDF | 1183480 | A-1183480 |
| SDF | 1129779 | A-1129779 | SDF | 1182426 | A-1182426 |
| SDF | 1137509 | A-1137509 | SDF | 1182428 | A-1182428 |
| SDF | 1136717 | A-1136717 | SDF | 1183129 | A-1183129 |
| SDF | 1130742 | A-1130742 | SDF | 1183130 | A-1183130 |
| SDF | 1146013 | A-1146013 | SDF | 1183131 | A-1183131 |
| SDF | 1146045 | A-1146045 | SDF | 1182293 | A-1182293 |
| SDF | 1139067 | A-1139067 | SDF | 1182373 | A-1182373 |
| SDF | 1129780 | A-1129780 | SDF | 1182732 | A-1182732 |
| SDF | 1139068 | A-1139068 | SDF | 1182733 | A-1182733 |
| SDF | 1146027 | A-1146027 | SDF | 1183133 | A-1183133 |
| SDF | 1139248 | A-1139248 | SDF | 1183134 | A-1183134 |
| SDF | 1139250 | A-1139250 | SDF | 1183135 | A-1183135 |
| SDF | 1139251 | A-1139251 | SDF | 1183335 | A-1183335 |
| SDF | 1101674 | A-1101674 | SDF | 1183704 | A-1183704 |
| SDF | 1136724 | A-1136724 | SDF | 1182470 | A-1182470 |
| SDF | 1136747 | A-1136747 | SDF | 1182558 | A-1182558 |
| SDF | 1129970 | A-1129970 | SDF | 1183136 | A-1183136 |
| SDF | 6240407 | A-6240407 | SDF | 1183371 | A-1183371 |
| SDF | 11116150117 | A-11116150117.00 | SDF | 1182432 | A-1182432 |
| SDF | 1136729 | A-1136729 | SDF | 1182423 | A-1182423 |
| SDF | 4156783 | A-4156783 | SDF | 1182425 | A-1182425 |
| SDF | 4154836 | A-4154836 | SDF | 1183137 | A-1183137 |
| SDF | 1180449 | A-1180449 | SDF | 1183138 | A-1183138 |
| SDF | 4156387 | A-4156387 | SDF | 1183139 | A-1183139 |
| SDF | 4154401 | A-4154401 | SDF | 1182294 | A-1182294 |
| SDF | 1181254 | A-1181254 | SDF | 1148079 | A-1148079 |
| SDF | 6215228 | A-6215228 | SDF | 1183398 | A-1183398 |
| SDF | 19951021 | A-1-99-51021 | SDF | 1148492 | A-1148492 |
| SDF | 1145980 | A-1145980 | SDF | 1183361 | A-1183361 |
| SDF | 1145640 | A-1145640 | SDF | 1148512 | A-1148512 |
| SDF | 1146032 | A-1146032 | SDF | 1183364 | A-1183364 |
| SDF | 1145877 | A-1145877 | SDF | 1182718 | A-1182718 |
| SDF | 1145348 | A-1145348 | SDF | 1183362 | A-1183362 |



SAME-DEUTZ-FAHR (SDF)

| OEM | OEM  Part No. | PIX  Part No. | OEM | OEM  Part No. | PIX  Part No. |
|-----|--|--|-----|--|--|
| SDF | 1182651 | A-1182651 | SDF | 2235530 | A-2235530 |
| SDF | 1183363 | A-1183363 | SDF | 1179476 | A-1179476 |
| SDF | 1183367 | A-1183367 | SDF | 1179852 | A-1179852 |
| SDF | 1183073 | A-1183073 | SDF | 1179888 | A-1179888 |
| SDF | 1183173 | A-1183173 | SDF | 2235260 | A-2235260 |
| SDF | 1183366 | A-1183366 | SDF | 603450501300 | A-603450501300 |
| SDF | 1168307 | A-1168307 | SDF | 1179674 | A-1179674 |
| SDF | 1168308 | A-1168308 | SDF | 2235714 | A-2235714 |
| SDF | 1161860 | A-1161860 | SDF | 2235816 | A-2235816 |
| SDF | 1162716 | A-1162716 | SDF | 4232845 | A-4232845 |
| SDF | 1164848 | A-1164848 | SDF | 1183023 | A-1183023 |
| SDF | 1169885 | A-1169885 | SDF | 1183024 | A-1183024 |
| SDF | 1169886 | A-1169886 | SDF | 1179718 | A-1179718 |
| SDF | 1174612 | A-1174612 | SDF | 1179749 | A-1179749 |
| SDF | 1181184 | A-1181184 | SDF | 12270924 | A-12270924 |
| SDF | 1175882 | A-1175882 | SDF | 1180830 | A-1180830 |
| SDF | 1175929 | A-1175929 | SDF | 1176304 | A-1176304 |
| SDF | 1179978 | A-1179978 | SDF | 1179477 | A-1179477 |
| SDF | 1182053 | A-1182053 | SDF | 1179480 | A-1179480 |
| SDF | 1175928 | A-1175928 | SDF | 1175924 | A-1175924 |
| SDF | 1179996 | A-1179996 | SDF | 1179675 | A-1179675 |
| SDF | 1180195 | A-1180195 | SDF | 1180194 | A-1180194 |
| SDF | 1182056 | A-1182056 | SDF | 603450201400 | A-603450201400 |
| SDF | 2235253 | A-2235253 | SDF | 1179720 | A-1179720 |
| SDF | 12500311 | A-12500311 | SDF | 1179722 | A-1179722 |
| SDF | 603450201100 | A-603450201100 | SDF | 2235261 | A-2235261 |
| SDF | 1156921 | A-1156921 | SDF | 1175960 | A-1175960 |
| SDF | 1179461 | A-1179461 | SDF | 1182810 | A-1182810 |
| SDF | 1180027 | A-1180027 | SDF | 603450201450 | A-603450201450 |
| SDF | 1179566 | A-1179566 | SDF | 2235262 | A-2235262 |
| SDF | 2235257 | A-2235257 | SDF | 1175766 | A-1175766 |
| SDF | 1154347 | A-1154347 | SDF | 1179779 | A-1179779 |
| SDF | 1180846 | A-1180846 | SDF | 1179478 | A-1179478 |
| SDF | 1154348 | A-1154348 | SDF | 1179481 | A-1179481 |
| SDF | 1154350 | A-1154350 | SDF | 1179780 | A-1179780 |
| SDF | 1182184 | A-1182184 | SDF | 1179781 | A-1179781 |
| SDF | 603450501200 | A-603450501200 | SDF | 1181897 | A-1181897 |
| SDF | 1176331 | A-1176331 | SDF | 1179782 | A-1179782 |
| SDF | 1179475 | A-1179475 | SDF | 1181675 | A-1181675 |
| SDF | 603450501225 | A-603450501225 | SDF | 1180434 | A-1180434 |
| SDF | 60345051225 | A-60345051225 | SDF | 1179471 | A-1179471 |
| SDF | 1182066 | A-1182066 | SDF | 1180640 | A-1180640 |
| SDF | 2235259 | A-2235259 | SDF | 1182064 | A-1182064 |
| SDF | 1176178 | A-1176178 | SDF | 1179472 | A-1179472 |
| SDF | 1180831 | A-1180831 | SDF | 1179648 | A-1179648 |
| SDF | 1179747 | A-1179747 | SDF | 1182050 | A-1182050 |
| SDF | 1179750 | A-1179750 | SDF | 1180901 | A-1180901 |



SAME-DEUTZ-FAHR (SDF)

| OEM | OEM  Part No. | PIX  Part No. | OEM | OEM  Part No. | PIX  Part No. |
|-----|--|--|-----|--|--|
| SDF | 1180709 | A-1180709 | SDF | 1180350 | A-1180350 |
| SDF | 1182065 | A-1182065 | SDF | 603450211275 | A-603450211275 |
| SDF | 2235377 | A-2235377 | SDF | 1180904 | A-1180904 |
| SDF | 603450200900 | A-603450200900 | SDF | 1182068 | A-1182068 |
| SDF | 1179474 | A-1179474 | SDF | 1154358 | A-1154358 |
| SDF | 1182045 | A-1182045 | SDF | 1174283 | A-1174283 |
| SDF | 1175745 | A-1175745 | SDF | 1178739 | A-1178739 |
| SDF | 1182051 | A-1182051 | SDF | 1180436 | A-1180436 |
| SDF | 1182207 | A-1182207 | SDF | 1182057 | A-1182057 |
| SDF | 673224 | A-0673224 | SDF | 1175974 | A-1175974 |
| SDF | 1179650 | A-1179650 | SDF | 1180612 | A-1180612 |
| SDF | 1179830 | A-1179830 | SDF | 1182062 | A-1182062 |
| SDF | 1182067 | A-1182067 | SDF | 603451111350 | A-603451111350 |
| SDF | 1175933 | A-1175933 | SDF | 1154305 | A-1154305 |
| SDF | 1180467 | A-1180467 | SDF | 1182185 | A-1182185 |
| SDF | 1182060 | A-1182060 | SDF | 12500125 | A-12500125 |
| SDF | 1180849 | A-1180849 | SDF | 1154306 | A-1154306 |
| SDF | 1182061 | A-1182061 | SDF | 1179673 | A-1179673 |
| SDF | 603450211050 | A-603450211050 | SDF | 603450211400 | A-603450211400 |
| SDF | 1154353 | A-1154353 | SDF | 603451111400 | A-603451111400 |
| SDF | 1182046 | A-1182046 | SDF | 603451311400 | A-603451311400 |
| SDF | 1182505 | A-1182505 | SDF | 4123559 | A-4123559 |
| SDF | 2418962 | A-2418962 | SDF | 1175939 | A-1175939 |
| SDF | 603450211075 | A-603450211075 | SDF | 4147300 | A-4147300 |
| SDF | 1178736 | A-1178736 | SDF | 12500285 | A-12500285 |
| SDF | 1179890 | A-1179890 | SDF | 603450211425 | A-603450211425 |
| SDF | 1179891 | A-1179891 | SDF | 1154307 | A-1154307 |
| SDF | 1180182 | A-1180182 | SDF | 1180437 | A-1180437 |
| SDF | 1182052 | A-1182052 | SDF | 1154308 | A-1154308 |
| SDF | 1154354 | A-1154354 | SDF | 1154359 | A-1154359 |
| SDF | 1154355 | A-1154355 | SDF | 1180438 | A-1180438 |
| SDF | 1181076 | A-1181076 | SDF | 603451311500 | A-603451311500 |
| SDF | 1182055 | A-1182055 | SDF | 1151369 | A-1151369 |
| SDF | 1182542 | A-1182542 | SDF | 1154310 | A-1154310 |
| SDF | 1182054 | A-1182054 | SDF | 12272665 | A-12272665 |
| SDF | 1175555 | A-1175555 | SDF | 12500218 | A-12500218 |
| SDF | 1178738 | A-1178738 | SDF | 1174834 | A-1174834 |
| SDF | 1180552 | A-1180552 | SDF | 603451111550 | A-603451111550 |
| SDF | 1181587 | A-1181587 | SDF | 12500121 | A-12500121 |
| SDF | 1183403 | A-1183403 | SDF | 1154312 | A-1154312 |
| SDF | 1175719 | A-1175719 | SDF | 603451111700 | A-603451111700 |
| SDF | 1175968 | A-1175968 | SDF | 1151370 | A-1151370 |
| SDF | 1177873 | A-1177873 | SDF | 1179456 | A-1179456 |
| SDF | 1180435 | A-1180435 | SDF | 1179639 | A-1179639 |
| SDF | 1154304 | A-1154304 | SDF | 1154351 | A-1154351 |
| SDF | 1175969 | A-1175969 | SDF | 1183250 | A-1183250 |
| SDF | 1175970 | A-1175970 | SDF | 12270923 | A-12270923 |

SAME-DEUTZ-FAHR (SDF)

| OEM | OEM  Part No. | PIX  Part No. |
|-----|--|--|
| SDF | 1180464 | A-1180464 |
| SDF | 1180663 | A-1180663 |
| SDF | 1182059 | A-1182059 |
| SDF | 1183019 | A-1183019 |
| SDF | 603451111075 | A-603451111075 |
| SDF | 12500266 | A-12500266 |
| SDF | 603450211375 | A-603450211375 |
| SDF | 110464 | A-110464 |
| SDF | 1139227 | A-1139227 |
| SDF | 1139228 | A-1139228 |
| SDF | 1136734 | A-1136734 |
| SDF | 1139230 | A-1139230 |
| SDF | 1139231 | A-1139231 |
| SDF | 6212870 | A-6212870 |
| SDF | 1139232 | A-1139232 |
| SDF | 1145991 | A-1145991 |
| SDF | 1139224 | A-1139224 |
| SDF | 6212828 | A-6212828 |
| SDF | 1132421 | A-1132421 |
| SDF | 1141555 | A-1141555 |
| SDF | 1141556 | A-1141556 |
| SDF | 1129970 | A-1129970 |
| SDF | 1136747 | A-1136747 |
| SDF | 603451391622 | A-603451391622 |
| SDF | 6215191 | A-6215191 |
| SDF | 6215192 | A-6215192 |
| SDF | 6215193 | A-6215193 |

SAMPO

| OEM | OEM  Part No. | PIX  Part No. |
|-------|--|--|
| SAMPO | 613116 | A-613116 |
| SAMPO | 613122 | A-613122 |
| SAMPO | 613124 | A-613124 |
| SAMPO | 613126 | A-613126 |
| SAMPO | 613128 | A-613128 |
| SAMPO | 614115 | A-614115 |
| SAMPO | 614125 | A-614125 |
| SAMPO | 614148 | A-614148 |
| SAMPO | 614152 | A-614152 |
| SAMPO | 614166 | A-614166 |
| SAMPO | 614212 | A-614212 |
| SAMPO | 614217 | A-614217 |
| SAMPO | 614222 | A-614222 |
| SAMPO | 614224 | A-614224 |
| SAMPO | 614226 | A-614226 |
| SAMPO | 614246 | A-614246 |
| SAMPO | 614260 | A-614260 |
| SAMPO | 615108 | A-615108 |
| SAMPO | 615129 | A-615129 |
| SAMPO | 615130 | A-615130 |
| SAMPO | 615133 | A-615133 |
| SAMPO | 0615135SA | A-615135SA |
| SAMPO | 615142 | A-615142 |
| SAMPO | 615150 | A-615150 |
| SAMPO | 615159 | A-615159 |
| SAMPO | 615161 | A-615161 |
| SAMPO | 615162 | A-615162 |
| SAMPO | 615163 | A-615163 |
| SAMPO | 615165 | A-615165 |
| SAMPO | 615167 | A-615167 |
| SAMPO | 615170 | A-615170 |
| SAMPO | 615173 | A-615173 |
| SAMPO | 615179 | A-615179 |
| SAMPO | 615189 | A-615189 |
| SAMPO | 619044 | A-619044 |
| SAMPO | 619054 | A-619054 |
| SAMPO | 619065 | A-619065 |
| SAMPO | 619071 | A-619071 |
| SAMPO | 619080 | A-619080 |
| SAMPO | 619081 | A-619081 |
| SAMPO | 619082 | A-619082 |
| SAMPO | 619083 | A-619083 |
| SAMPO | 619091 | A-619091 |
| SAMPO | 619092 | A-619092 |
| SAMPO | 619095 | A-619095 |
| SAMPO | 619096 | A-619096 |
| SAMPO | 619168 | A-619168 |
| SAMPO | 1472227 | A-147227 |
| SAMPO | 614221 | A-614221 |
| SAMPO | 615169 | A-615169 |

SAMPO

| OEM | OEM Part No. | PIX Part No. |
|-------|--------------|--------------|
| SAMPO | 619169 | A-619169 |
| SAMPO | 619170 | A-619170 |
| SAMPO | 619174 | A-619174 |
| SAMPO | 619175 | A-619175 |
| SAMPO | 619179 | A-619179 |
| SAMPO | 619181 | A-619181 |
| SAMPO | 619182 | A-619182 |
| SAMPO | 619185 | A-619185 |
| SAMPO | R634644 | A-R634644 |
| SAMPO | R634650A | A-R634650A |
| SAMPO | R634655 | A-R634655 |
| SAMPO | R644247A | A-R644247A |
| SAMPO | R652307A | A-R652307A |
| SAMPO | R680791 | A-R680791 |
| SAMPO | R680812B | A-R680812B |
| SAMPO | R694252A | A-R694252A |
| SAMPO | R694253 | A-R694253 |
| SAMPO | R694254 | A-R694254 |
| SAMPO | R694255A | A-R694255A |
| SAMPO | R694256 | A-R694256 |
| SAMPO | R694263 | A-R694263 |
| SAMPO | R694943 | A-R694943 |
| SAMPO | R696665 | A-R696665 |
| SAMPO | R698062 | A-R698062 |
| SAMPO | R698063 | A-R698063 |
| SAMPO | R700327 | A-R700327 |
| SAMPO | R700328 | A-R700328 |
| SAMPO | R701183 | A-R701183 |
| SAMPO | R706495 | A-R706495 |
| ZMAJ | 837223100 | A-837223100 |

ZMAJ

| OEM | OEM Part No. | PIX Part No. |
|------|--------------|--------------|
| ZMAJ | 69011671 | A-69-011671 |
| ZMAJ | 833341369 | A-833341369 |
| ZMAJ | 837171980 | A-837171980 |
| ZMAJ | 833342046 | A-833342046 |
| ZMAJ | 833362380 | A-833362380 |
| ZMAJ | 833362410 | A-833362410 |
| ZMAJ | 833683750 | A-833683750 |
| ZMAJ | 832321213 | A-832321213 |
| ZMAJ | 832321540 | A-832321540 |
| ZMAJ | 832321795 | A-832321795 |
| ZMAJ | 833551959 | A-833551959 |
| ZMAJ | 833553180 | A-833553180 |
| ZMAJ | 833353335 | A-833353335 |
| ZMAJ | 833553520 | A-833553520 |
| ZMAJ | 833553810 | A-833553810 |
| ZMAJ | 832451630 | A-832451630 |
| ZMAJ | 832451715 | A-832451715 |
| ZMAJ | 832451755 | A-832451755 |
| ZMAJ | 832451810 | A-832451810 |
| ZMAJ | 690107/1 | A-69-0107/1 |
| ZMAJ | 832453165 | A-0832453165 |
| ZMAJ | 832503190 | A-0832503190 |
| ZMAJ | 832602130 | A-0832602130 |
| ZMAJ | 720211 | A-72-0211 |
| ZMAJ | 7101556 | A-71-01556 |
| ZMAJ | 690104 | A-69-0104 |
| ZMAJ | 831225600 | A-0831225600 |
| ZMAJ | 832321795 | A-832321795 |
| ZMAJ | 833551959 | A-833551959 |
| ZMAJ | 833553180 | A-833553180 |
| ZMAJ | 833353335 | A-833353335 |
| ZMAJ | 833553520 | A-833553520 |
| ZMAJ | 833553810 | A-833553810 |
| ZMAJ | 832451630 | A-832451630 |
| ZMAJ | 832451715 | A-832451715 |
| ZMAJ | 832451755 | A-832451755 |
| ZMAJ | 832451810 | A-832451810 |
| ZMAJ | 690107/1 | A-69-0107/1 |
| ZMAJ | 832453165 | A-0832453165 |
| ZMAJ | 832503190 | A-0832503190 |
| ZMAJ | 832602130 | A-0832602130 |
| ZMAJ | 720211 | A-72-0211 |
| ZMAJ | 7101556 | A-71-01556 |
| ZMAJ | 690104 | A-69-0104 |
| ZMAJ | 831225600 | A-0831225600 |

Preventive Maintenance Tips

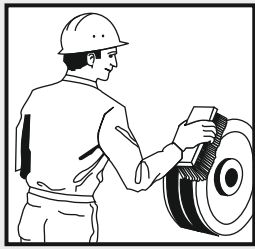

Before proceeding for the maintenance of drive, switch the mains off. Check the pulley for rust or wear, clean it if required.

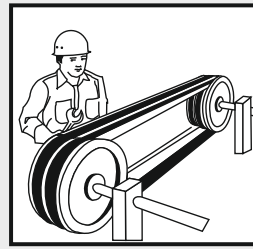

Drive should never be kept open, protect the drive with the help of a suitable drive guard.



Avoid dressing of belts, never do this under any circumstances.

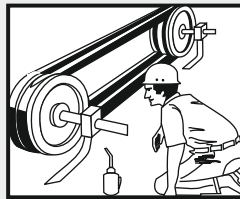

Be alert all the times, look and listen for anything unwanted, correct it immediately.

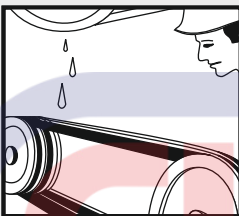

Do not expose the belts to oil, spray, liquid, paste or hazardous chemicals, which are incompatible with the belt material.

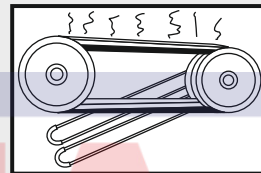

Belts operating at elevated temperatures above 70°C, should be checked periodically. Use special heat resistant belts to avoid this problem.

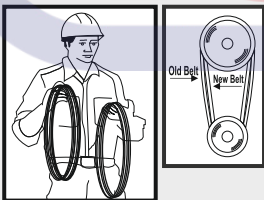

Do not mix the belts of various brands, types, used & new ones.

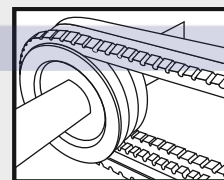

Belt turn over is due to misalignment, worn out pulleys or excessive vibrations.

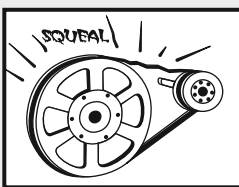

Squeal is a result of insufficient belt tension. If it continues even after re-tensioning, the drive should be examined for overload. Correct the design, if required.

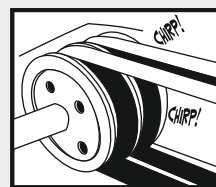

The noise like chirping of birds occurs because of dust or dry bearings. Clean and lubricate the bearings regularly.

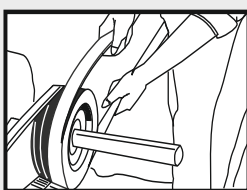

Always use installation allowance so the belts can easily be installed in the pulley grooves. Switch off the drive before changing the belts.

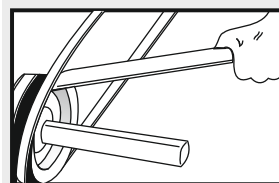

Never place the belt by applying force with the help of a screw driver or a lever. It may damage the fabric top cover, the cords may also break. A belt so fitted will turn over in the pulley.

Preventive Maintenance Tips

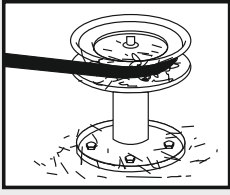

Presence of foreign material can result into excessive wear or breakage of belt.

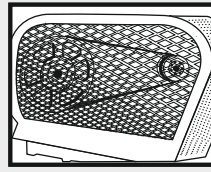

Belt guard is a must to ensure safety and cleanliness. Screened meshed or grilled guards are the best for heat dissipation. Select a proper mesh size which will prevent the entry of human finger or any other object.

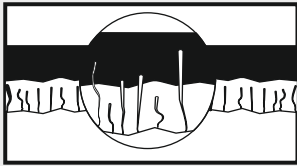

Check the belt for cracks at the bottom surface. Cracks can be avoided by using large-diameter and larger reverse bend idler pulleys.

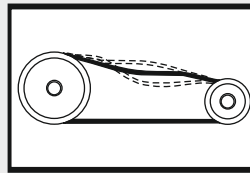

Prevent the whipping of belts. Re-tension them or use belts from same manufacturer or avoid using new and used belts together.

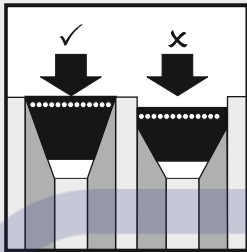

Inspect pulley grooves. Worn out grooves provide allowance for the belts to slip, leading to a premature failure. Use PIX pulley gauges to check the pulley grooves.



Change in ride out/in indicates uneven belt wear or worn-out pulleys.



Do not allow belts to vibrate laterally.





5+

DECADES OF EXPERTISE
& EXPERIENCE



80K+

EXTENSIVE
PRODUCT RANGE



6

GLOBAL
LOCATIONS



100+

COUNTRIES
GLOBAL FOOTPRINT

ISO
9001:2015

IATF
16949:2016

ISO
14001:2015

ISO
45001:2018

Corporate Office



PIX Transmissions Ltd.

B-1208, 12th Floor, One BKC,
Bandra-Kurla, Complex Bandra (East),
Mumbai - 400051
Maharashtra, India

☎ +91-(0)-22-61383000
✉ info@pixtrans.com
🌐 www.pixtrans.com

Registered Office



PIX Transmissions Ltd.

J-7, M.I.D.C. Hingna Road,
Nagpur - 440016
Maharashtra, India

☎ +91-(0)-7104 669 000
✉ info@pixtrans.com
🌐 www.pixtrans.com

Overseas Offices



PIX Germany GmbH

Karl-Schurz-Str. 35
33100 Paderborn, Germany

☎ +49 (0) 5251-2844 070
☎ +49 (0) 5251-2844 099
✉ info@pixgermany.com
🌐 www.pixgermany.de



PIX Transmissions (Europe) Ltd.

12, Sterling Complex, Farthing
Road, Ipswich, Suffolk IP1 5AP
United Kingdom

☎ +44 (0) 1473-743 511
☎ +44 (0) 1473-742 227
✉ info@pixtranseu.com
🌐 www.pixtranseu.com



PIX Middle East Trading LLC

Warehouse No-7 & 9, Near RAK BANK,
Industrial Area-2. P.O. Box 238085,
Near UAE Exchange,
Al Qusais Ind-2, Dubai, U.A.E.

☎ +971-4-2345 100
☎ +971-4-2345 101
✉ info@pixme.ae
🌐 www.pixme.ae



PIX Middle East Trading LLC

Souq Al Ghazal Building,
Near Bin Thani Plaza, Deira,
P.O. Box 238085, Dubai, UAE

☎ +971-438-52128
✉ info@pixme.ae
🌐 www.pixme.ae