

Pilot Bore Sprockets

BS Pilot Bore Sprockets

03B 5 x 2.5 mm

SPROCKET	mm	CHAIN	mm
Tooth Radius r_3	5.0	Pitch	5.000
Chamfer c	0.6	Width Between Inner Plates	2.500
Tooth Width B1	2.3	Roller Diameter	3.200

Type 1 (C45)

Teeth	Outer Dia de	Pitch Dia dp	Hub Dia dm	Simplex Length thro' Bore A	Stock Bore D1	Type
8	15.2	13.06	7	10	4	1
9	16.8	14.62	8	10	5	1
10	18.3	16.18	9	10	5	1
11	19.9	17.75	11	10	6	1
12	21.5	19.32	12	10	6	1
13	23.0	20.89	14	10	6	1
14	24.6	22.47	15	10	6	1
15	26.2	24.04	16	10	6	1
16	27.8	25.63	18	13	8	1
17	29.4	27.20	18	13	8	1
18	30.9	28.79	18	13	8	1
19	32.5	30.38	18	13	8	1
20	34.1	31.96	18	13	8	1
21	35.7	33.54	20	13	8	1
22	37.3	35.13	20	13	8	1
23	38.9	36.72	20	13	8	1
24	40.5	38.30	20	13	8	1
25	42.0	39.89	20	13	8	1
26	43.6	41.48	25	15	8	1
27	45.2	43.07	25	15	8	1
28	46.8	44.65	25	15	8	1
29	48.4	46.25	25	15	8	1
30	50.0	47.83	25	15	8	1
31	51.6	49.42	30	15	8	1
32	53.2	51.01	30	15	8	1
33	54.8	52.60	30	15	8	1
34	56.3	54.19	30	15	8	1
35	57.9	55.78	30	15	8	1
36	59.5	57.37	30	15	8	1
37	61.1	58.96	30	15	8	1
38	62.7	60.54	30	15	8	1
39	64.3	62.13	30	15	8	1
40	65.9	63.73	30	15	8	1

Pilot Bore Sprockets

BS Pilot Bore Sprockets

04B 6 x 2.8 mm

SPROCKET	mm	CHAIN	mm
Tooth Radius r_3	6.0	Pitch	6.000
Chamfer c	0.7	Width Between Inner Plates	2.800
Tooth Width B1	2.6	Roller Diameter	4.000

Type 1 (C45)

Teeth	Outer Dia de	Pitch Dia dp	Hub Dia dm	Simplex Length thro' Bore A	Stock Bore D1	Type
8	18.0	15.67	9.8	10	5	1
9	19.9	17.54	11.5	10	5	1
10	21.7	19.42	13.0	10	6	1
11	23.6	21.30	14.0	10	6	1
12	25.4	23.18	16.0	10	6	1
13	27.3	25.05	18.0	10	6	1
14	29.2	26.96	20.0	10	6	1
15	31.1	28.86	20.0	10	6	1
16	33.0	30.76	20.0	13	8	1
17	35.0	32.65	20.0	13	8	1
18	36.9	34.55	20.0	13	8	1
19	38.8	36.44	20.0	13	8	1
20	40.7	38.34	20.0	13	8	1
21	42.6	40.25	25.0	13	8	1
22	44.5	42.16	25.0	13	8	1
23	46.4	44.06	25.0	13	8	1
24	48.3	45.96	25.0	13	8	1
25	50.2	47.87	25.0	13	8	1
26	52.1	49.77	30.0	15	8	1
27	54.0	51.67	30.0	15	8	1
28	55.9	53.58	30.0	15	8	1
29	57.8	55.50	30.0	15	8	1
30	59.8	57.42	30.0	15	8	1
31	61.7	59.31	30.0	15	10	1
32	63.6	61.21	30.0	15	10	1
33	65.5	63.11	30.0	15	10	1
34	67.4	65.02	30.0	15	10	1
35	69.3	66.93	30.0	15	10	1
36	71.2	68.84	30.0	15	10	1
37	73.1	70.75	30.0	15	10	1
38	75.0	72.66	30.0	15	10	1
39	76.9	74.56	30.0	15	10	1
40	78.9	76.47	30.0	15	10	1
45	88.5	86.01	40.0	18	12	1
50	98.0	95.55	50.0	20	12	1
57	111.4	108.93	50.0	20	12	1

All dimensions in millimetres unless otherwise stated. Every effort has been taken to ensure that the data listed in this catalogue is correct. Challenge accepts no liability for any inaccuracies or damage caused.

Pilot Bore Sprockets

BS Pilot Bore Sprockets

05B		8 x 3 mm	
SPROCKET	mm	CHAIN	mm
Tooth Radius r_3	8.0	Pitch	8.000
Chamfer c	1.0	Width Between Inner Plates	3.000
Tooth Width b_1	2.7	Roller Diameter	5.000
Tooth Width B_1	2.8		
Tooth Width B_2	8.3		

Type 1 (C45)

Type 1 (C45)

Teeth	Outer Dia d_e	Pitch Dia d_p	Simplex			Duplex			Type
			Hub Dia d_m	Length thro' Bore A	Stock Bore D_1	Hub Dia d_m	Length thro' Bore A	Stock Bore D_1	
8	24.0	20.90	13	12	6	12	18	6	1
9	26.6	23.39	15	12	6	15	18	6	1
10	29.2	25.89	17	12	6	17	18	8	1
11	31.7	28.39	18	13	7	19	18	8	1
12	34.2	30.91	20	13	7	21	18	8	1
13	36.7	33.42	23	13	7	24	18	8	1
14	39.2	35.95	25	13	7	26	18	8	1
15	41.7	38.48	28	13	7	29	18	8	1
16	44.3	41.01	30	14	8	32	20	10	1
17	46.8	43.53	30	14	8	34	20	10	1
18	49.3	46.07	30	14	8	37	20	10	1
19	51.9	48.61	30	14	8	39	20	10	1
20	54.4	51.14	30	14	8	40	20	10	1
21	57.0	53.67	35	14	8	40	20	10	1
22	59.5	56.21	35	14	8	40	20	10	1
23	62.0	58.75	35	14	8	40	20	10	1
24	64.6	61.29	35	14	8	40	20	10	1
25	67.5	63.83	35	14	8	40	20	10	1
26	69.5	66.37	40	16	10	50	22	12	1
27	72.2	68.91	40	16	10	50	22	12	1
28	74.8	71.45	40	16	10	50	22	12	1
29	77.3	73.99	40	16	10	50	22	12	1
30	79.8	76.53	40	16	10	50	22	12	1
31	82.4	79.08	40	16	12	60	22	12	1
32	84.9	81.61	40	16	12	60	22	12	1
33	87.5	84.16	40	16	12	60	22	12	1
34	90.0	86.70	40	16	12	60	22	12	1
35	92.5	89.24	40	16	12	60	22	12	1
36	95.0	91.79	40	16	12	60	22	12	1
37	97.6	94.33	40	16	12	60	22	12	1
38	100.2	96.88	40	16	12	60	22	12	1
39	102.7	99.42	40	16	12	60	22	12	1
40	105.2	101.97	40	16	12	60	22	12	1
45	118.0	114.69	60	20	12	-	-	-	1
50	130.7	127.41	60	20	12	-	-	-	1
57	148.6	145.22	80	20	14	-	-	-	1
76	197.9	193.59	78	34.4	-	-	-	-	1

Every effort has been taken to ensure that the data listed in this catalogue is correct. Challenge accepts no liability for any inaccuracies or damage caused. All dimensions in millimetres unless otherwise stated.

Pilot Bore Sprockets

BS Pilot Bore Sprockets

06B 3/8" x 7/32"

SPROCKET		CHAIN	
	mm		mm
Tooth Radius r_3	10.0	Pitch	9.525
Chamfer c	1.0	Width Between Inner Plates	5.720
Tooth Width b_1	5.2	Roller Diameter	6.350
Tooth Width B_1	5.3		
Tooth Width B_2	15.4		
Tooth Width B_3	25.6		

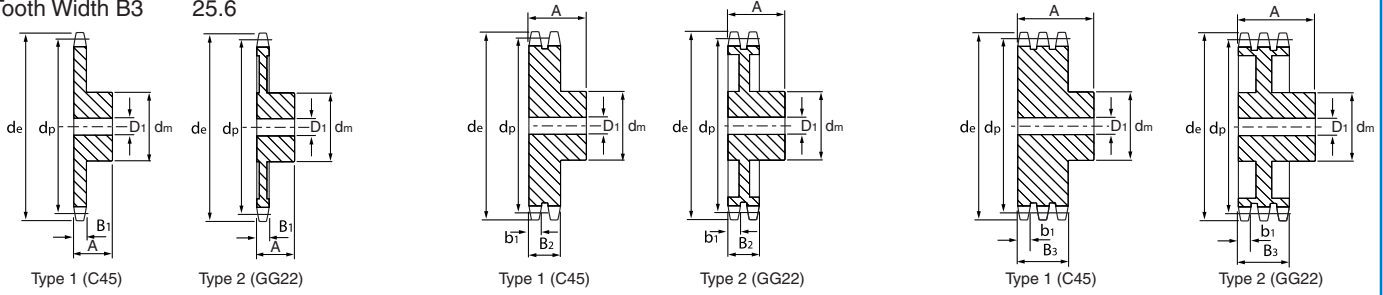
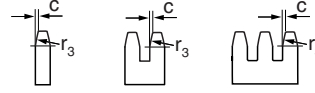

Teeth	Outer Dia d_e	Pitch Dia d_p	Simplex			Duplex			Triplex			Type
			Hub Dia d_m	Length thro' Bore A	Stock Bore D_1	Hub Dia d_m	Length thro' Bore A	Stock Bore D_1	Hub Dia d_m	Length thro' Bore A	Stock Bore D_1	
8	28.0	24.89	15	22	8	15	22	8	15	32	8	1
9	31.0	27.85	18	22	8	18	22	8	18	32	8	1
10	34.0	30.82	20	22	8	20	22	8	20	32	10	1
11	37.0	33.80	22	25	8	22	25	10	22	35	12	1
12	40.0	36.80	25	25	8	25	25	10	25	35	12	1
13	43.0	39.80	28	25	10	28	25	10	28	35	12	1
14	46.3	42.80	31	25	10	31	25	10	31	35	12	1
15	49.3	45.81	34	25	10	34	25	10	34	35	12	1
16	52.3	48.82	37	28	10	37	30	12	37	35	12	1
17	55.3	51.83	40	28	10	40	30	12	40	35	12	1
18	58.3	54.85	43	28	10	43	30	12	43	35	12	1
19	61.3	57.87	45	28	10	46	30	12	46	35	12	1
20	64.3	60.89	46	28	10	49	30	12	49	35	12	1
21	68.0	63.91	48	28	12	52	30	16	52	40	16	1
22	71.0	66.93	50	28	12	55	30	16	55	40	16	1
23	73.5	69.95	52	28	12	58	30	16	58	40	16	1
24	77.0	72.97	54	28	12	61	30	16	61	40	16	1
25	80.0	76.00	57	28	12	64	30	16	64	40	16	1
26	83.0	79.02	60	28	12	67	30	16	67	40	16	1
27	86.0	82.04	60	28	12	70	30	16	70	40	16	1
28	89.0	85.07	60	28	12	73	30	16	73	40	16	1
29	92.0	88.09	60	28	12	76	30	16	76	40	16	1
30	94.7	91.12	60	28	12	79	30	16	79	40	16	1
31	98.3	94.15	65	30	14	80	30	16	80	40	16	1
32	101.3	97.17	65	30	14	80	30	16	80	40	16	1
33	104.3	100.20	65	30	14	80	30	16	80	40	16	1
34	107.3	103.23	65	30	14	80	30	16	85	40	16	1
35	110.4	106.26	65	30	14	80	30	16	85	40	16	1
36	113.4	109.29	70	30	14	90	30	16	90	40	16	1
37	116.4	112.32	70	30	14	90	30	16	90	40	16	1
38	119.5	115.34	70	30	14	90	30	16	90	40	16	1
39	122.5	118.37	70	30	14	90	30	16	90	40	16	1
40	125.5	121.40	70	30	14	90	30	16	90	40	16	1
38	119.5	115.34	70	32	20	80	40	20	90	56	24	2
45	140.7	136.54	70	32	20	80	40	20	90	56	24	2
57	176.9	172.91	70	32	20	80	40	20	90	56	24	2
76	234.9	230.49	70	32	20	80	40	20	100	56	24	2
95	292.5	288.08	80	40	20	90	45	20	100	56	24	2
114	349.6	345.68	80	40	20	95	45	20	100	56	24	2

All dimensions in millimetres unless otherwise stated. Every effort has been taken to ensure that the data listed in this catalogue is correct. Challenge accepts no liability for any inaccuracies or damage caused.

Pilot Bore Sprockets

BS Pilot Bore Sprockets

081		1/2" x 1/8"	
SPROCKET	mm	CHAIN	mm
Tooth Radius r_3	13.0	Pitch	12.700
Chamfer c	1.0	Width Between Inner Plates	3.300
Tooth Width B1	3.0	Roller Diameter	7.750

Type 1 (C45)

Teeth	Outer Dia d_e	Pitch Dia d_p	Hub Dia d_m	Simplex Length thro' Bore A	Stock Bore D_1	Type
8	37.2	33.18	21	14	8	1
9	41.5	37.13	25	14	8	1
10	46.2	41.10	28	14	8	1
11	49.6	45.07	31	16	8	1
12	53.9	49.07	35	16	8	1
13	58.4	53.06	39	16	8	1
14	62.8	57.07	43	16	8	1
15	66.8	61.09	47	16	8	1
16	70.9	65.10	50	18	10	1
17	74.9	69.11	50	18	10	1
18	78.9	73.14	50	18	10	1
19	82.9	77.16	50	18	10	1
20	86.9	81.19	50	18	10	1
21	91.0	85.22	60	20	12	1
22	95.0	89.24	60	20	12	1
23	99.0	93.27	60	20	12	1
24	103.0	97.29	60	20	12	1
25	107.1	101.33	60	20	12	1
26	111.2	105.36	70	20	16	1
27	115.4	109.40	70	20	16	1
28	119.4	113.42	70	20	16	1
29	123.4	117.46	70	20	16	1
30	127.5	121.50	70	20	16	1
31	131.5	125.54	70	20	16	1
32	135.5	129.56	70	20	16	1
33	139.6	133.60	70	20	16	1
34	143.6	137.64	70	20	16	1
35	147.6	141.68	70	20	16	1
36	151.7	145.72	70	25	16	1
37	155.7	149.76	70	25	16	1
38	159.8	153.80	70	25	16	1
39	163.8	157.83	70	25	16	1
40	167.8	161.87	70	25	16	1

Pilot Bore Sprockets

BS Pilot Bore Sprockets

083 / 084 1/2" x 3/16"

SPROCKET	mm	CHAIN	mm
Tooth Radius r_3	13.0	Pitch	12.700
Chamfer c	1.3	Width Between Inner Plates	4.880
Tooth Width B1	4.5	Roller Diameter	7.750

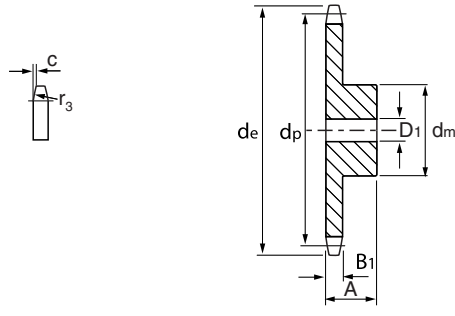

Type 1 (C45)

Teeth	Outer Dia de	Pitch Dia dp	Hub Dia dm	Simplex Length thro' Bore A	Stock Bore D1	Type
8	38.5	33.18	21	14	8	1
9	41.5	37.13	25	14	8	1
10	46.2	41.10	28	14	8	1
11	49.6	45.07	31	16	8	1
12	53.9	49.07	35	16	8	1
13	58.4	53.06	39	16	8	1
14	62.8	57.07	43	16	8	1
15	66.8	61.09	47	16	8	1
16	70.9	65.10	50	18	10	1
17	74.9	69.10	50	18	10	1
18	78.9	73.14	50	18	10	1
19	82.9	77.16	50	18	10	1
20	86.9	81.19	50	18	10	1
21	91.0	85.22	60	20	12	1
22	95.0	89.24	60	20	12	1
23	99.0	93.27	60	20	12	1
24	103.0	97.29	60	20	12	1
25	107.1	101.33	60	20	12	1
26	111.2	105.36	70	20	16	1
27	115.4	109.40	70	20	16	1
28	119.4	113.42	70	20	16	1
29	123.4	117.46	70	20	16	1
30	127.5	121.50	70	20	16	1
31	131.5	125.54	70	20	16	1
32	135.5	129.56	70	20	16	1
33	139.6	133.60	70	20	16	1
34	143.6	137.64	70	20	16	1
35	147.6	141.68	70	20	16	1
36	151.7	145.72	70	25	16	1
37	155.7	149.76	70	25	16	1
38	159.8	153.80	70	25	16	1
39	163.8	157.83	70	25	16	1
40	167.8	161.87	70	25	16	1

All dimensions in millimetres unless otherwise stated. Every effort has been taken to ensure that the data listed in this catalogue is correct. Challenge accepts no liability for any inaccuracies or damage caused.

Pilot Bore Sprockets

BS Pilot Bore Sprockets

085		1/2" x 1/4"	
SPROCKET	mm	CHAIN	mm
Tooth Radius r_3	13.0	Pitch	12.700
Chamfer c	1.3	Width Between Inner Plates	6.400
Tooth Width B_i	5.9	Roller Diameter	7.750

Type 1 (C45)

Teeth	Outer Dia d_e	Pitch Dia d_p	Hub Dia d_m	Simplex Length thro' Bore A	Stock Bore D_1	Type
8	38.5	33.18	20	25	10	1
9	41.5	37.13	24	25	10	1
10	46.2	41.10	26	25	10	1
11	49.6	45.07	29	25	10	1
12	53.9	49.07	33	28	10	1
13	58.4	53.06	37	28	10	1
14	62.8	57.07	41	28	10	1
15	66.8	61.09	45	28	10	1
16	70.9	65.10	50	28	12	1
17	74.9	69.11	52	28	12	1
18	78.9	73.14	56	28	12	1
19	82.9	77.16	60	28	12	1
20	86.9	81.19	64	28	12	1
21	91.0	85.22	68	28	14	1
22	95.0	89.24	70	28	14	1
23	99.0	93.27	70	28	14	1
24	103.0	97.29	70	28	14	1
25	107.1	101.33	70	28	14	1
26	111.2	105.36	70	30	16	1
27	115.4	109.40	70	30	16	1
28	119.4	113.42	70	30	16	1
29	123.4	117.46	80	30	16	1
30	127.5	121.50	80	30	16	1
31	131.5	125.54	90	30	16	1
32	135.5	129.56	90	30	16	1
33	139.6	133.60	90	30	16	1
34	143.6	137.64	90	30	16	1
35	147.6	141.68	90	30	16	1
36	151.7	145.72	90	35	16	1
37	155.7	149.76	90	35	16	1
38	159.8	153.80	90	35	16	1
39	163.8	157.83	90	35	16	1
40	167.8	161.87	90	35	16	1

Pilot Bore Sprockets

BS Pilot Bore Sprockets

08B 1/2" x 5/16"

SPROCKET		CHAIN	
	mm		mm
Tooth Radius r_3	13.0	Pitch	12.700
Chamfer c	1.3	Width Between Inner Plates	7.750
Tooth Width b_1	7.0	Roller Diameter	8.510
Tooth Width B_1	7.2		
Tooth Width B_2	21.0		
Tooth Width B_3	34.9		

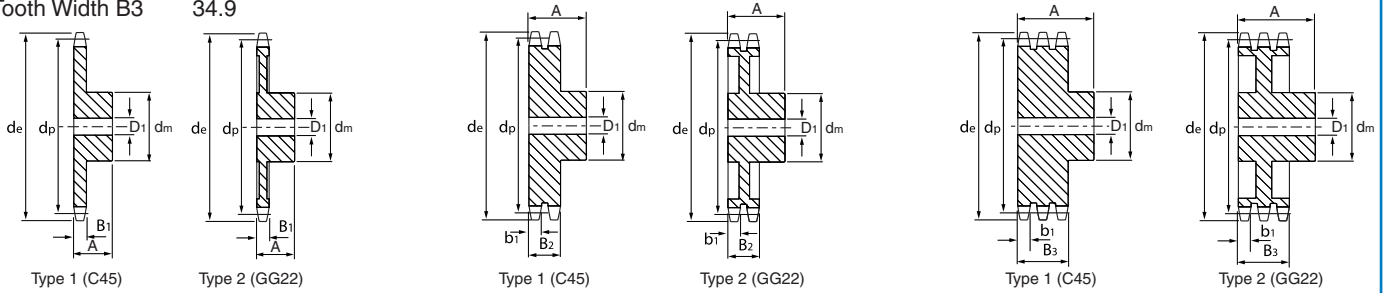
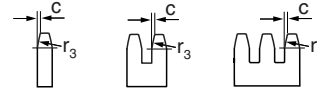

Teeth	Outer Dia d_e	Pitch Dia d_p	Simplex			Duplex			Triplex			Type
			Hub Dia d_m	Length thro' Bore A	Stock Bore D_1	Hub Dia d_m	Length thro' Bore A	Stock Bore D_1	Hub Dia d_m	Length thro' Bore A	Stock Bore D_1	
8	37.2	33.18	20	25	10	20	32	10	20	46	10	1
9	41.0	37.13	24	25	10	24	32	10	24	46	12	1
10	45.2	41.10	26	25	10	28	32	10	28	46	12	1
11	48.7	45.07	29	25	10	32	35	12	32	50	16	1
12	53.0	49.07	33	28	10	35	35	12	35	50	16	1
13	57.4	53.06	37	28	10	38	35	12	38	50	16	1
14	61.8	57.07	41	28	10	42	35	12	42	50	16	1
15	65.5	61.09	45	28	10	46	35	12	46	50	16	1
16	69.5	65.10	50	28	12	50	38	14	50	50	16	1
17	73.6	69.11	52	28	12	54	38	14	54	50	16	1
18	77.8	73.14	56	28	12	58	38	14	58	50	16	1
19	81.7	77.16	60	28	12	62	38	14	62	50	16	1
20	85.8	81.19	64	28	12	66	38	14	66	50	16	1
21	89.7	85.22	68	28	14	70	40	16	70	55	20	1
22	93.8	89.24	70	28	14	70	40	16	70	55	20	1
23	98.2	93.27	70	28	14	70	40	16	70	55	20	1
24	101.8	97.29	70	28	14	75	40	16	75	55	20	1
25	105.8	101.33	70	28	14	80	40	16	80	55	20	1
26	110.0	105.36	70	30	16	85	40	20	85	55	20	1
27	114.0	109.40	70	30	16	85	40	20	85	55	20	1
28	118.0	113.42	70	30	16	90	40	20	90	55	20	1
29	122.0	117.46	80	30	16	95	40	20	95	55	20	1
30	126.1	121.50	80	30	16	100	40	20	100	55	20	1
31	130.2	125.54	90	30	16	100	40	20	110	55	20	1
32	134.3	129.56	90	30	16	100	40	20	110	55	20	1
33	138.4	133.60	90	30	16	100	40	20	110	55	20	1
34	142.6	137.64	90	30	16	100	40	20	110	55	20	1
35	146.7	141.68	90	30	16	100	40	20	110	55	20	1
36	151.0	145.72	90	35	20	100	40	20	120	55	25	1
37	154.6	149.76	90	35	20	100	40	20	120	55	25	1
38	158.6	153.80	90	35	20	100	40	20	120	55	25	1
39	162.7	157.83	90	35	20	100	40	20	120	55	25	1
40	166.8	161.87	90	35	20	100	40	20	120	55	25	1
38	158.6	153.80	70	40	24	90	50	24	100	60	24	2
45	188.0	182.07	70	40	24	90	50	24	100	60	24	2
57	236.4	230.54	70	40	24	90	50	24	100	60	24	2
76	313.3	307.33	80	40	24	100	56	24	100	60	24	2
95	390.1	384.11	80	45	24	100	56	24	120	67	24	2
114	466.9	460.90	80	45	25	100	63	25	120	67	25	2

All dimensions in millimetres unless otherwise stated. Every effort has been taken to ensure that the data listed in this catalogue is correct. Challenge accepts no liability for any inaccuracies or damage caused.

Pilot Bore Sprockets

BS Pilot Bore Sprockets

10B 5/8" x 3/8"

SPROCKET		CHAIN	
	mm		mm
Tooth Radius r_3	16.0	Pitch	15.875
Chamfer c	1.6	Width Between Inner Plates	9.650
Tooth Width b_1	9.0	Roller Diameter	10.160
Tooth Width B_1	9.1		
Tooth Width B_2	25.5		
Tooth Width B_3	42.1		

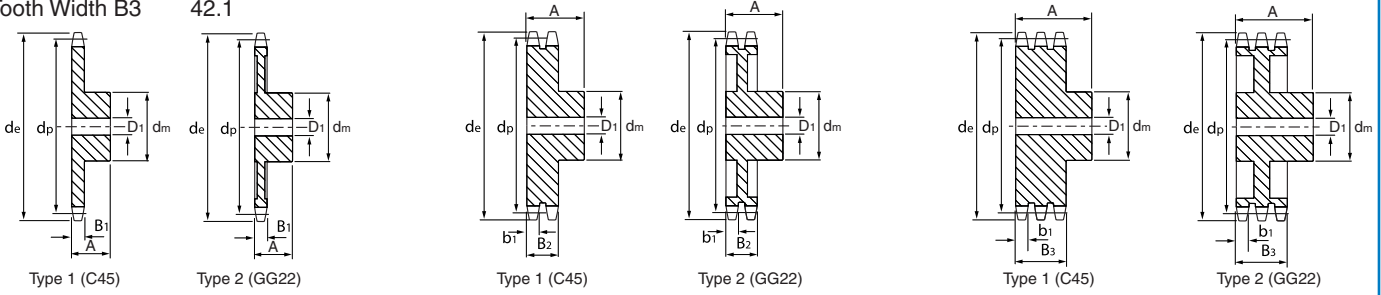
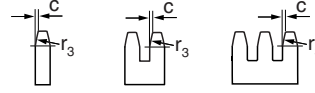

Teeth	Outer Dia d_e	Pitch Dia d_p	Simplex			Duplex			Triplex			Type
			Hub Dia d_m	Length thro' Bore A	Stock Bore D_1	Hub Dia d_m	Length thro' Bore A	Stock Bore D_1	Hub Dia d_m	Length thro' Bore A	Stock Bore D_1	
8	47.0	41.48	25	25	10	25	40	12	25	55	12	1
9	52.6	46.42	30	25	10	30	40	12	30	55	12	1
10	57.5	51.37	35	25	10	35	40	12	35	55	16	1
11	63.0	56.34	37	30	12	39	40	14	39	55	16	1
12	68.0	61.34	42	30	12	44	40	14	44	55	16	1
13	73.0	66.32	47	30	12	49	40	14	49	55	16	1
14	78.0	71.34	52	30	12	54	40	14	54	55	16	1
15	83.0	76.36	57	30	12	59	40	14	59	55	16	1
16	88.0	81.37	60	30	14	64	45	16	64	60	16	1
17	93.0	86.39	60	30	14	69	45	16	69	60	16	1
18	98.3	91.42	70	30	14	74	45	16	74	60	16	1
19	103.3	96.45	70	30	14	79	45	16	79	60	16	1
20	108.4	101.49	75	30	14	84	45	16	84	60	16	1
21	113.4	106.52	75	30	16	85	45	16	85	60	20	1
22	118.0	111.55	80	30	16	90	45	16	90	60	20	1
23	123.4	116.58	80	30	16	95	45	16	95	60	20	1
24	128.3	121.62	80	30	16	100	45	16	100	60	20	1
25	134.0	126.66	80	30	16	105	45	16	105	60	20	1
26	139.0	131.70	85	35	20	110	45	20	110	60	20	1
27	144.0	136.75	85	35	20	110	45	20	110	60	20	1
28	148.7	141.78	90	35	20	115	45	20	115	60	20	1
29	153.8	146.83	90	35	20	115	45	20	115	60	20	1
30	158.8	151.87	90	35	20	120	45	20	120	60	20	1
31	163.9	156.92	95	35	20	120	45	20	120	60	20	1
32	168.9	161.95	95	35	20	120	45	20	120	60	20	1
33	174.5	167.00	95	35	20	120	45	20	120	60	20	1
34	179.0	172.05	95	35	20	120	45	20	120	60	20	1
35	184.1	177.10	95	35	20	120	45	20	120	60	20	1
36	189.1	182.15	100	35	20	120	45	20	120	60	25	1
37	194.2	187.20	100	35	20	120	45	20	120	60	25	1
38	199.2	192.24	100	35	20	120	45	20	120	60	25	1
39	204.2	197.29	100	35	20	120	45	20	120	60	25	1
40	209.3	202.34	100	35	20	120	45	20	120	60	25	1
38	199.2	192.24	80	40	24	100	50	30	100	60	32	2
45	235.0	227.58	80	40	24	100	50	30	100	60	32	2
57	296.0	288.18	90	45	24	100	56	30	100	63	32	2
76	392.1	384.16	90	50	24	100	63	30	110	67	35	2
95	488.5	480.14	100	56	24	110	63	30	125	70	35	2
114	584.1	576.13	100	56	25	125	70	30	125	80	35	2

Every effort has been taken to ensure that the data listed in this catalogue is correct. Challenge accepts no liability for any inaccuracies or damage caused. All dimensions in millimetres unless otherwise stated.

Pilot Bore Sprockets

BS Pilot Bore Sprockets

12B 3/4" x 7/16"

SPROCKET

Tooth Radius r_3	19.0
Chamfer c	2.0
Tooth Width b_1	10.8
Tooth Width B_1	11.1
Tooth Width B_2	30.3
Tooth Width B_3	49.8

CHAIN

Pitch	19.050
Width Between Inner Plates	11.680
Roller Diameter	12.070

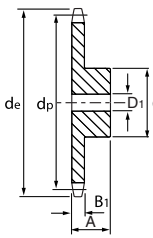
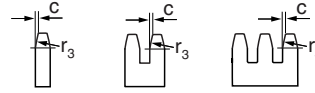

Type 1 (C45)

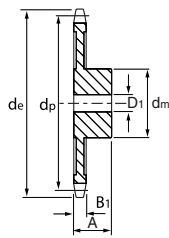

Type 2 (GG22)

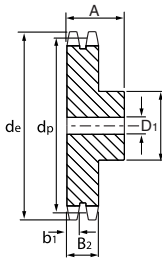

Type 1 (C45)

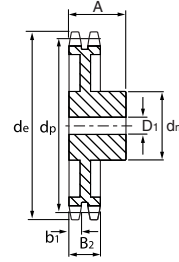

Type 2 (GG22)

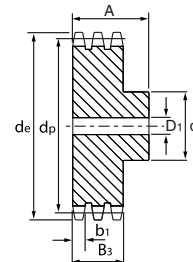

Type 1 (C45)

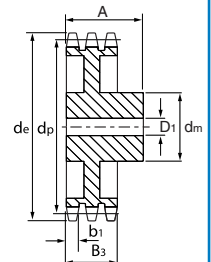

Type 2 (GG22)

Teeth	Outer Dia d_e	Pitch Dia d_p	Simplex			Duplex			Triplex			Type
			Hub Dia d_m	Length thro' Bore A	Stock Bore D_1	Hub Dia d_m	Length thro' Bore A	Stock Bore D_1	Hub Dia d_m	Length thro' Bore A	Stock Bore D_1	
8	57.6	49.78	31	30	12	31	45	12	31	65	16	1
9	62.0	55.70	37	30	12	37	45	12	37	65	16	1
10	69.0	61.64	42	30	12	42	45	12	42	65	16	1
11	75.0	67.61	46	35	14	47	50	16	47	70	20	1
12	81.5	73.60	52	35	14	53	50	16	53	70	20	1
13	87.5	79.59	58	35	14	59	50	16	59	70	20	1
14	93.6	85.61	64	35	14	65	50	16	65	70	20	1
15	99.8	91.63	70	35	14	71	50	16	71	70	20	1
16	105.5	97.65	75	35	16	77	50	20	77	70	20	1
17	111.5	103.67	80	35	16	83	50	20	83	70	20	1
18	118.0	109.71	80	35	16	89	50	20	89	70	20	1
19	124.2	115.75	80	35	16	95	50	20	95	70	20	1
20	129.7	121.78	80	35	16	100	50	20	100	70	20	1
21	136.0	127.82	90	40	20	100	50	20	100	70	20	1
22	141.8	133.86	90	40	20	100	50	20	100	70	20	1
23	149.0	139.90	90	40	20	110	50	20	110	70	20	1
24	153.9	145.94	90	40	20	110	50	20	110	70	20	1
25	160.0	152.00	90	40	20	120	50	20	120	70	20	1
26	165.9	158.04	95	40	20	120	50	20	120	70	20	1
27	172.3	164.09	95	40	20	120	50	20	120	70	20	1
28	178.0	170.13	95	40	20	120	50	20	120	70	20	1
29	184.1	176.19	95	40	20	120	50	20	120	70	20	1
30	190.5	182.25	95	40	20	120	50	20	120	70	20	1
31	196.3	188.31	100	40	20	120	50	20	130	70	25	1
32	203.3	194.35	100	40	20	120	50	20	130	70	25	1
33	209.3	200.40	100	40	20	120	50	20	130	70	25	1
34	214.6	206.46	100	40	20	120	50	20	130	70	25	1
35	221.0	212.52	100	40	20	120	50	20	130	70	25	1
36	226.8	218.58	100	40	25	120	50	25	130	70	25	1
37	232.9	224.64	100	40	25	120	50	25	130	70	25	1
38	239.0	230.69	100	40	25	120	50	25	130	70	25	1
39	245.1	236.75	100	40	25	120	50	25	130	70	25	1
40	251.3	242.81	100	40	25	120	50	25	130	70	25	1
38	239.0	230.69	100	56	24	110	63	30	140	70	30	2
45	282.5	273.10	100	56	24	110	63	30	140	70	30	2
57	355.4	345.81	100	56	30	120	63	30	140	70	40	2
76	469.9	460.99	100	56	30	135	63	30	160	75	40	2
95	585.1	576.17	100	65	30	135	70	30	170	82	40	2
114	700.6	691.36	100	65	30	135	70	30	170	82	40	2

All dimensions in millimetres unless otherwise stated. Every effort has been taken to ensure that the data listed in this catalogue is correct. Challenge accepts no liability for any inaccuracies or damage caused.

Pilot Bore Sprockets

BS Pilot Bore Sprockets

16B 1" x 17.02 mm

SPROCKET		CHAIN	
	mm		mm
Tooth Radius r_3	26.0	Pitch	25.400
Chamfer c	2.5	Width Between Inner Plates	17.020
Tooth Width b_1	15.8	Roller Diameter	15.880
Tooth Width B_1	16.2		
Tooth Width B_2	47.7		
Tooth Width B_3	79.6		

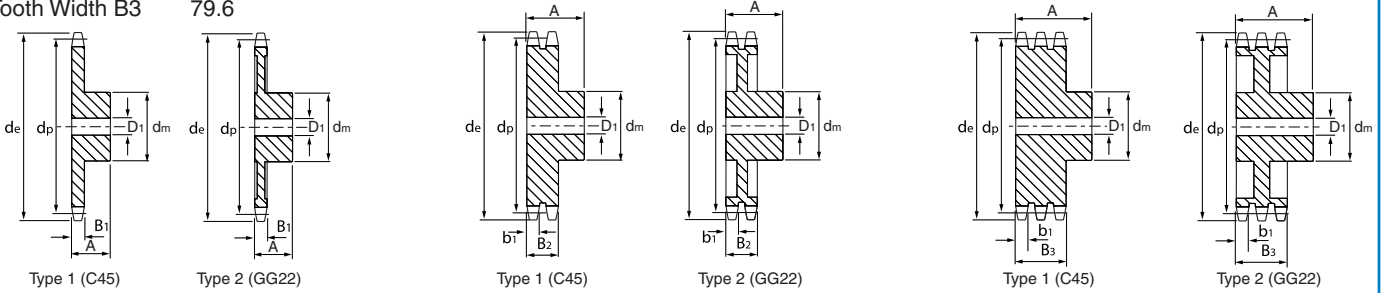
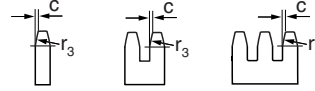

Teeth	Outer Dia d_e	Pitch Dia d_p	Simplex			Duplex			Triplex			Type
			Hub Dia d_m	Length thro' Bore A	Stock Bore D_1	Hub Dia d_m	Length thro' Bore A	Stock Bore D_1	Hub Dia d_m	Length thro' Bore A	Stock Bore D_1	
8	77.0	66.37	42	35	16	42	65	16	42	95	20	1
9	85.0	74.27	50	35	16	50	65	16	50	95	20	1
10	93.0	82.19	55	35	16	56	65	16	56	95	20	1
11	99.5	90.14	61	40	16	64	70	20	64	100	25	1
12	109.0	98.14	69	40	16	72	70	20	72	100	25	1
13	117.0	106.12	78	40	16	80	70	20	80	100	25	1
14	125.0	114.15	84	40	16	88	70	20	88	100	25	1
15	133.0	122.17	92	40	16	96	70	20	96	100	25	1
16	141.0	130.20	100	45	20	104	70	25	104	100	30	1
17	149.0	138.22	100	45	20	112	70	25	112	100	30	1
18	157.0	146.28	100	45	20	120	70	25	120	100	30	1
19	165.2	154.33	100	45	20	128	70	25	128	100	30	1
20	173.2	162.38	100	45	20	130	70	25	130	100	30	1
21	181.2	170.43	110	50	20	130	70	25	130	100	30	1
22	189.3	178.48	110	50	20	130	70	25	130	100	30	1
23	197.5	186.53	110	50	20	130	70	25	130	100	30	1
24	205.5	194.59	110	50	20	130	70	25	130	100	30	1
25	213.5	202.66	110	50	20	130	70	25	130	100	30	1
26	221.6	210.72	120	50	20	130	70	25	130	100	30	1
27	229.6	218.79	120	50	20	130	70	25	130	100	30	1
28	237.7	226.85	120	50	20	130	70	25	130	100	30	1
29	245.8	234.92	120	50	20	130	70	25	130	100	30	1
30	254.0	243.00	120	50	20	130	70	25	130	100	30	1
31	262.0	251.08	120	50	25	140	70	25	140	100	30	1
32	270.0	259.13	120	50	25	140	70	25	140	100	30	1
33	278.5	267.21	120	50	25	140	70	25	140	100	30	1
34	287.0	275.28	120	50	25	140	70	25	140	100	30	1
35	296.2	283.36	120	50	25	140	70	25	140	100	30	1
36	304.6	291.44	120	50	25	140	70	25	140	100	30	1
37	312.6	299.51	120	50	25	140	70	25	140	100	30	1
38	320.7	307.59	120	50	25	140	70	25	140	100	30	1
39	328.8	315.67	120	50	25	140	70	25	140	100	30	1
40	336.9	323.75	120	50	25	140	70	25	140	100	30	1
30	254.0	243.00	110	65	30	125	75	40	145	90	40	2
38	320.0	307.59	110	65	30	140	75	40	160	100	45	2
45	377.0	364.12	125	70	30	150	75	40	160	100	45	2
57	474.0	461.07	125	70	35	170	90	40	165	100	45	2
76	627.0	614.65	140	80	35	175	95	40	200	110	45	2
95	781.0	768.22	140	80	40	175	95	45	200	110	50	2

Every effort has been taken to ensure that the data listed in this catalogue is correct. Challenge accepts no liability for any inaccuracies or damage caused. All dimensions in millimetres unless otherwise stated.

Pilot Bore Sprockets

BS Pilot Bore Sprockets

20B 1.1/4" x 3/4"

SPROCKET		CHAIN	
	mm		mm
Tooth Radius r_3	32.0	Pitch	31.750
Chamfer c	3.5	Width Between Inner Plates	19.560
Tooth Width b_1	18.2	Roller Diameter	19.050
Tooth Width B_1	18.5		
Tooth Width B_2	54.6		
Tooth Width B_3	91.0		

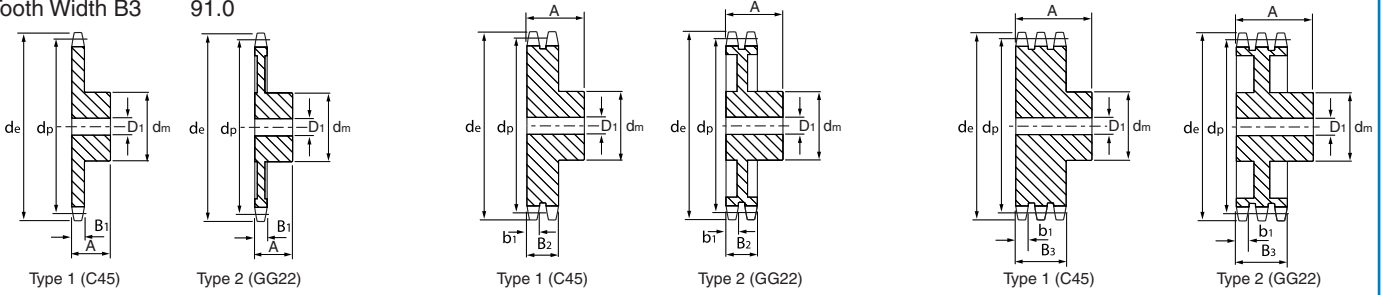
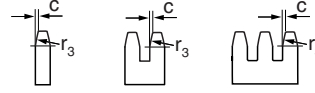

Teeth	Outer Dia d_e	Pitch Dia d_p	Simplex			Duplex			Triplex			Type
			Hub Dia d_m	Length thro' Bore A	Stock Bore D_1	Hub Dia d_m	Length thro' Bore A	Stock Bore D_1	Hub Dia d_m	Length thro' Bore A	Stock Bore D_1	
8	98.1	82.96	53	40	20	53	75	20	53	110	25	1
9	108.0	92.84	63	40	20	63	75	20	63	110	25	1
10	117.9	102.74	70	40	20	70	75	20	70	110	25	1
11	127.8	112.68	77	45	20	80	80	25	80	115	30	1
12	137.8	122.68	88	45	20	90	80	25	90	115	30	1
13	147.8	132.65	98	45	20	100	80	25	100	115	30	1
14	157.8	142.68	108	45	20	110	80	25	110	115	30	1
15	167.9	152.72	118	45	20	120	80	25	120	115	30	1
16	177.9	162.75	120	50	25	120	80	30	120	115	30	1
17	187.9	172.78	120	50	25	120	80	30	120	115	30	1
18	198.0	182.85	120	50	25	120	80	30	120	115	30	1
19	208.1	192.91	120	50	25	120	80	30	120	115	30	1
20	218.1	202.98	120	50	25	120	80	30	120	115	30	1
21	228.2	213.04	140	55	30	140	80	30	140	115	30	1
22	238.3	223.11	140	55	30	140	80	30	140	115	30	1
23	248.3	233.17	140	55	30	140	80	30	140	115	30	1
24	258.4	243.23	140	55	30	140	80	30	140	115	30	1
25	268.5	253.33	140	55	30	140	80	30	140	115	30	1
26	278.6	263.40	150	55	30	150	80	30	150	115	30	1
27	288.6	273.80	150	55	30	150	80	30	150	115	30	1
28	298.7	283.56	150	55	30	150	80	30	150	115	30	1
29	308.8	293.65	150	55	30	150	80	30	150	115	30	1
30	318.9	303.75	150	55	30	150	80	30	150	115	30	1
31	329.0	313.85	150	55	30	150	80	30	150	115	30	1
32	339.1	323.91	150	55	30	150	80	30	150	115	30	1
33	349.2	334.01	150	55	30	150	80	30	150	115	30	1
34	359.3	344.10	150	55	30	150	80	30	150	115	30	1
35	369.4	354.20	150	55	30	150	80	30	150	115	30	1
36	379.5	364.30	150	55	30	150	80	30	150	115	30	1
37	389.5	374.39	150	55	30	150	80	30	150	115	30	1
38	399.6	384.49	150	55	30	150	80	30	150	115	30	1
39	409.7	394.59	150	55	30	150	80	30	150	115	30	1
40	419.8	404.66	150	55	30	150	80	30	150	115	30	1
30	318.9	303.75	115	70	35	130	80	40	160	100	50	2
38	399.6	384.49	125	70	35	140	90	45	180	110	56	2
45	470.3	455.17	125	70	35	140	90	45	180	110	56	2
57	591.5	576.36	135	80	40	160	100	50	180	125	63	2
76	783.5	768.32	140	90	50	180	100	56	200	140	63	2
95	976.9	960.28	-	-	-	180	100	60	220	140	70	2

All dimensions in millimetres unless otherwise stated. Every effort has been taken to ensure that the data listed in this catalogue is correct. Challenge accepts no liability for any inaccuracies or damage caused.

Pilot Bore Sprockets

BS Pilot Bore Sprockets

24B 1.1/2" x 1"

SPROCKET		CHAIN	
	mm		mm
Tooth Radius r_3	38.0	Pitch	38.100
Chamfer c	4.0	Width Between Inner Plates	25.400
Tooth Width b_1	23.6	Roller Diameter	25.400
Tooth Width B_1	24.1		
Tooth Width B_2	72.0		
Tooth Width B_3	120.3		

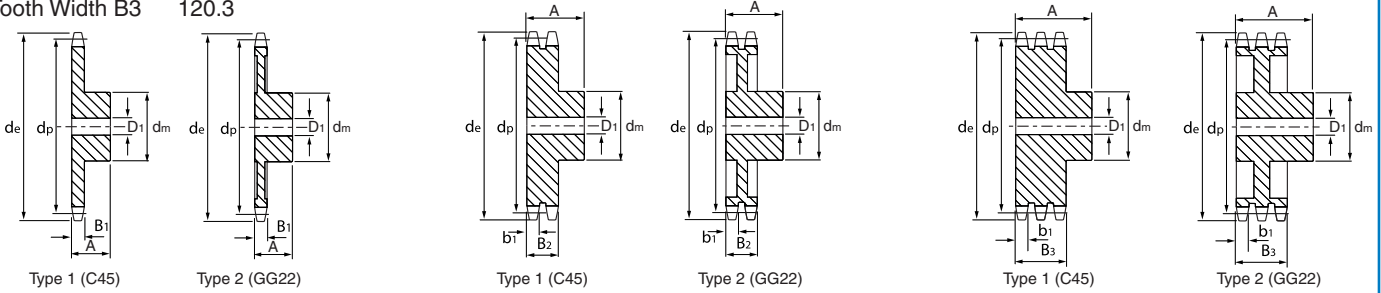
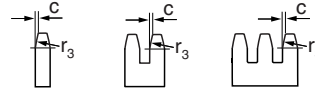

Teeth	Outer Dia d_e	Pitch Dia d_p	Simplex			Duplex			Triplex			Type
			Hub Dia d_m	Length thro' Bore A	Stock Bore D_1	Hub Dia d_m	Length thro' Bore A	Stock Bore D_1	Hub Dia d_m	Length thro' Bore A	Stock Bore D_1	
8	115.0	99.55	58	45	20	58	95	25	58	140	25	1
9	126.4	111.40	70	45	20	70	95	25	70	140	25	1
10	138.0	123.29	80	45	20	80	95	25	80	140	25	1
11	150.0	135.21	90	50	25	90	100	25	90	150	30	1
12	162.0	147.22	102	50	25	102	100	25	102	150	30	1
13	174.2	159.18	114	50	25	114	100	25	114	150	30	1
14	186.2	171.22	128	50	25	128	100	25	128	150	30	1
15	198.2	183.26	140	50	25	140	100	25	132	150	30	1
16	210.3	195.30	140	55	25	140	100	30	136	150	30	1
17	222.3	207.34	140	55	25	150	100	30	140	150	30	1
18	234.3	219.42	140	55	25	150	100	30	150	150	30	1
19	246.5	231.49	140	55	25	160	100	30	160	150	30	1
20	258.6	243.57	140	55	25	160	100	30	160	150	30	1
21	270.6	255.65	150	60	30	160	100	30	160	150	40	1
22	282.7	267.73	150	60	30	160	100	30	160	150	40	1
23	294.8	279.80	150	60	30	160	100	30	160	150	40	1
24	306.8	291.88	150	60	30	160	100	30	160	150	40	1
25	319.0	304.00	150	60	30	160	100	30	160	150	40	1
26	331.0	316.08	160	60	30	160	100	30	160	150	40	1
27	343.2	328.19	160	60	30	160	100	30	160	150	40	1
28	355.2	340.27	160	60	30	160	100	30	160	150	40	1
29	367.3	352.38	160	60	30	160	100	30	160	150	40	1
30	379.5	364.50	160	60	30	160	100	30	160	150	40	1
31	391.6	376.62	160	60	30	160	100	40	160	150	40	1
32	403.7	388.69	160	60	30	160	100	40	160	150	40	1
33	415.8	400.81	160	60	30	160	100	40	160	150	40	1
34	427.8	412.93	160	60	30	160	100	40	160	150	40	1
35	440.0	425.04	160	60	30	160	100	40	160	150	40	1
36	452.0	437.16	160	60	30	160	100	40	160	150	40	1
37	464.2	449.27	160	60	30	160	100	40	160	150	40	1
38	476.2	461.39	160	60	30	160	100	40	160	150	40	1
39	488.5	473.50	160	60	30	160	100	40	160	150	40	1
40	500.6	485.62	160	60	30	160	100	40	160	150	40	1
30	379.5	364.50	130	85	40	160	95	40	180	150	60	2
38	476.2	461.39	140	90	45	180	100	45	200	150	60	2
45	561.2	546.20	140	90	45	180	100	45	200	150	60	2
57	706.5	691.63	160	100	45	200	110	55	200	150	70	2
76	936.9	921.98	170	100	45	220	120	55	-	-	-	2
95	1167.3	1152.33	200	125	50	220	140	55	-	-	-	2
114	1402.8	1382.72	-	-	-	-	-	-	230	160	75	2

Every effort has been taken to ensure that the data listed in this catalogue is correct. Challenge accepts no liability for any inaccuracies or damage caused. All dimensions in millimetres unless otherwise stated.

Pilot Bore Sprockets

BS Pilot Bore Sprockets

28B 1.3/4" x 1.1/4"

SPROCKET		CHAIN	
	mm		mm
Tooth Radius r_3	44.0	Pitch	44.450
Chamfer c	5.0	Width Between Inner Plates	30.990
Tooth Width b_1	28.8	Roller Diameter	27.940
Tooth Width B_1	29.4		
Tooth Width B_2	88.4		
Tooth Width B_3	148.0		

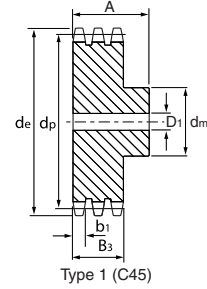
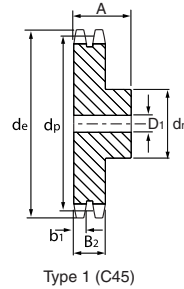
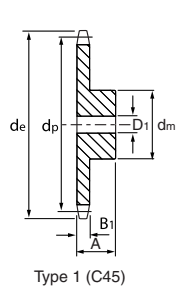
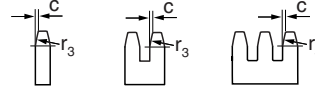

Teeth	Outer Dia d_e	Pitch Dia d_p	Simplex			Duplex			Triplex			Type
			Hub Dia d_m	Length thro' Bore A	Stock Bore D_1	Hub Dia d_m	Length thro' Bore A	Stock Bore D_1	Hub Dia d_m	Length thro' Bore A	Stock Bore D_1	
8	132.0	116.15	74	70	25	74	120	30	74	180	30	1
9	148.4	129.96	88	70	25	88	120	30	88	180	30	1
10	162.3	143.85	100	70	25	100	120	30	100	180	30	1
11	176.3	157.77	112	70	25	112	120	30	112	180	30	1
12	189.3	171.74	125	70	25	125	120	30	125	180	30	1
13	204.2	185.75	125	70	25	125	120	30	125	180	30	1
14	218.2	199.76	130	70	25	130	120	30	130	180	30	1
15	232.3	213.79	145	70	25	145	120	30	145	180	30	1
16	246.3	227.84	160	75	30	160	120	30	160	180	30	1
17	260.0	241.90	160	75	30	160	120	30	160	180	30	1
18	274.0	255.98	160	75	30	160	120	30	160	180	30	1
19	289.0	270.06	160	75	30	180	120	30	180	180	30	1
20	303.0	284.15	160	75	30	180	120	30	180	180	30	1
21	317.0	298.24	170	75	30	180	120	30	180	180	40	1
22	331.0	312.34	170	75	30	180	120	30	180	180	40	1
23	345.0	326.44	170	75	30	180	120	30	180	180	40	1
24	359.0	340.55	170	75	30	180	120	30	180	180	40	1
25	373.0	354.66	170	75	30	180	120	30	180	180	40	1
26	387.0	368.77	170	75	30	180	120	40	180	180	40	1
27	401.0	382.88	170	75	30	180	120	40	180	180	40	1
28	416.0	397.00	170	75	30	180	120	40	180	180	40	1
29	430.0	411.12	170	75	30	180	120	40	180	180	40	1
30	444.0	425.24	170	75	30	180	120	40	180	180	40	1
31	458.0	439.37	180	75	30	200	120	40	200	180	40	1
32	472.0	453.49	180	75	30	200	120	40	200	180	40	1
33	486.0	467.62	180	75	30	200	120	40	200	180	40	1
34	500.0	481.75	180	75	30	200	120	40	200	180	40	1
35	514.0	495.88	180	75	30	200	120	40	200	180	40	1
36	529.0	510.01	180	75	30	200	120	40	200	180	40	1
37	543.0	524.13	180	75	30	200	120	40	200	180	40	1
38	557.0	538.27	180	75	30	200	120	40	200	180	40	1
39	571.0	552.40	180	75	30	200	120	40	200	180	40	1
40	585.0	566.54	180	75	30	200	120	40	200	180	40	1

All dimensions in millimetres unless otherwise stated. Every effort has been taken to ensure that the data listed in this catalogue is correct. Challenge accepts no liability for any inaccuracies or damage caused.

Pilot Bore Sprockets

BS Pilot Bore Sprockets

32B 2" x 1.1/4"

SPROCKET		CHAIN	
	mm		mm
Tooth Radius r_3	51.0	Pitch	50.800
Chamfer c	6.0	Width Between Inner Plates	30.990
Tooth Width b1	28.8	Roller Diameter	29.210
Tooth Width B1	29.4		
Tooth Width B2	87.4		
Tooth Width B3	146.0		

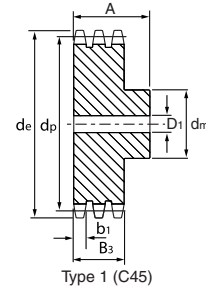
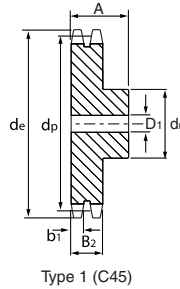
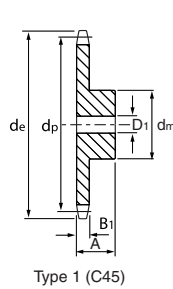
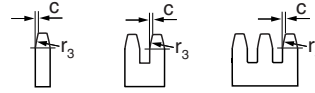

Teeth	Outer Dia de	Pitch Dia dp	Simplex			Duplex			Triplex			Type
			Hub Dia dm	Length thro' Bore A	Stock Bore D1	Hub Dia dm	Length thro' Bore A	Stock Bore D1	Hub Dia dm	Length thro' Bore A	Stock Bore D1	
8	153.2	132.74	85	80	30	85	120	30	85	180	30	1
9	169.0	148.54	100	80	30	100	120	30	100	180	30	1
10	185.0	164.39	115	80	30	115	120	30	115	180	30	1
11	200.8	180.31	125	80	30	125	120	35	125	180	35	1
12	216.8	196.29	133	80	30	133	120	35	133	180	35	1
13	232.8	212.29	145	80	30	145	120	35	145	180	35	1
14	248.8	228.29	155	80	30	155	120	35	155	180	35	1
15	264.8	244.30	160	80	30	160	120	35	160	180	35	1
16	280.9	260.40	160	90	30	160	120	40	160	180	40	1
17	296.9	276.46	170	90	30	180	120	40	180	180	40	1
18	313.0	292.55	170	90	30	180	120	40	180	180	40	1
19	329.1	308.66	170	90	30	200	120	40	200	180	40	1
20	345.2	324.71	180	90	30	200	120	40	200	180	40	1
21	361.3	340.82	180	90	40	200	120	40	200	180	40	1
22	377.5	356.98	180	90	40	200	120	40	200	180	40	1
23	393.6	373.08	180	90	40	200	120	40	200	180	40	1
24	409.7	389.18	180	90	40	200	120	40	200	180	40	1
25	425.8	405.33	180	90	40	200	120	40	200	180	40	1
26	441.9	421.44	180	90	40	200	120	40	200	180	40	1
27	458.1	437.59	180	90	40	200	120	40	200	180	40	1
28	474.2	453.69	180	90	40	200	120	40	200	180	40	1
29	492.0	469.85	180	90	40	-	-	-	-	-	-	1
30	506.5	486.00	180	90	40	200	120	40	200	180	40	1
32	538.8	518.27	180	90	40	-	-	-	-	-	-	1
35	589.5	566.71	180	90	40	-	-	-	-	-	-	1
38	635.5	615.16	180	90	40	-	-	-	-	-	-	1
40	670.3	647.47	180	90	40	-	-	-	-	-	-	1

Every effort has been taken to ensure that the data listed in this catalogue is correct. Challenge accepts no liability for any inaccuracies or damage caused. All dimensions in millimetres unless otherwise stated.